

**D-Link *AirPremier*<sup>TM</sup>**  
**DWL-2200AP**  
**802.11g Wireless**  
**108Mbps Access Point with PoE**

**Manual**

**D-Link<sup>®</sup>**  
**Building Networks for People**

# Contents

Package Contents .....	3
Introduction .....	4
LEDs and Connections .....	5
Features .....	6
Wireless Basics .....	7
Installation Considerations .....	9
Getting Started .....	10
Using the Configuration Menu .....	13
Using the AP Manager .....	31
Troubleshooting .....	45
Technical Specifications .....	52
Contacting Technical Support .....	55
Warranty.....	56

# Package Contents



## Contents of Package:

- **D-Link AirPremier™ DWL-2200AP**  
802.11g Wireless 108Mbps\* Access Point with PoE
- Power over Ethernet base unit
- Power Adapter-DC 48V, 0.4A
- Power cord
- Manual and Warranty on CD
- Quick Installation Guide
- Ethernet Cable

If any of the above items are missing, please contact your reseller.

*Note: Using a power supply with a different voltage rating than the one included with the DWL-2200AP will cause damage and void the warranty for this product.*

## System Requirements for Configuration:

- Computers with Windows, Macintosh, or Linux-based operating systems with an installed Ethernet adapter
- Internet Explorer Version 6.0 or Netscape Navigator Version 6.0 and Above

\*Maximum wireless signal rate derived from IEEE Standard 802.11g specifications. Actual data throughput will vary. Network conditions and environmental factors lower actual data throughput rate.

# Introduction

At up to fifteen times the speed of previous wireless devices (maximum wireless signal rate of up to 108Mbps\* in Super G mode), you can work faster and more efficiently, increasing productivity. With the DWL-2200AP, bandwidth-intensive applications like graphics or multimedia will benefit significantly because large files are able to move across the network quickly.

The DWL-2200AP is capable of operating in one of 4 different modes to meet your wireless networking needs. The DWL-2200AP can operate as an access point, or in access point-to-access point bridging mode, or in access point-to-multipoint bridging mode, or as a repeater.

Use less wiring, enjoy increased flexibility, save time and money with PoE (Power over Ethernet). With PoE, the DWL-2200AP shares power and data over the CAT5e cable, making the setup of your network less expensive and more convenient.

An ideal solution for quickly creating and extending a wireless local area network (WLAN) in offices or other workplaces, trade shows and special events, the DWL-2200AP provides data transfers at up to 108Mbps in Super G mode when used with other D-Link *AirPremier* products. (The 802.11g standard is backwards compatible with 802.11b devices.)

The DWL-2200AP has the newest, strongest and most advanced security features available today. When used with other 802.11 WPA (Wi-Fi Protected Access) compatible products in a network with a RADIUS server, the security features include:

**WPA: Wi-Fi Protected Access** which authorizes and identifies users based on a secret key that changes automatically at regular intervals. WPA uses TKIP (Temporal Key Integrity Protocol) to change the temporal key every 10,000 packets (a packet is a kind of message transmitted over a network.) This ensures much greater security than the standard WEP security. (By contrast, the previous WEP encryption implementations required the keys to be changed manually.)

For home users that will not incorporate a RADIUS server in their network, the security for the DWL-2200AP, used in conjunction with other WPA-compatible 802.11 products, will still be much stronger than ever before. Utilizing the **Pre-Shared Key mode** of WPA, the DWL-2200AP will obtain a new security key every time it connects to the 802.11 network. You only need to input your encryption information once in the configuration menu. No longer will you have to manually input a new WEP key frequently to ensure security. With the DWL-2200AP, you will automatically receive a new key every time you connect, vastly increasing the safety of your communication.

\*Maximum wireless signal rate derived from IEEE Standard 802.11g specifications. Actual data throughput will vary. Network conditions and environmental factors lower actual data throughput rate.

# LEDs

LED stands for light-emitting diode.  
The DWL-2200AP has 3 LEDs.

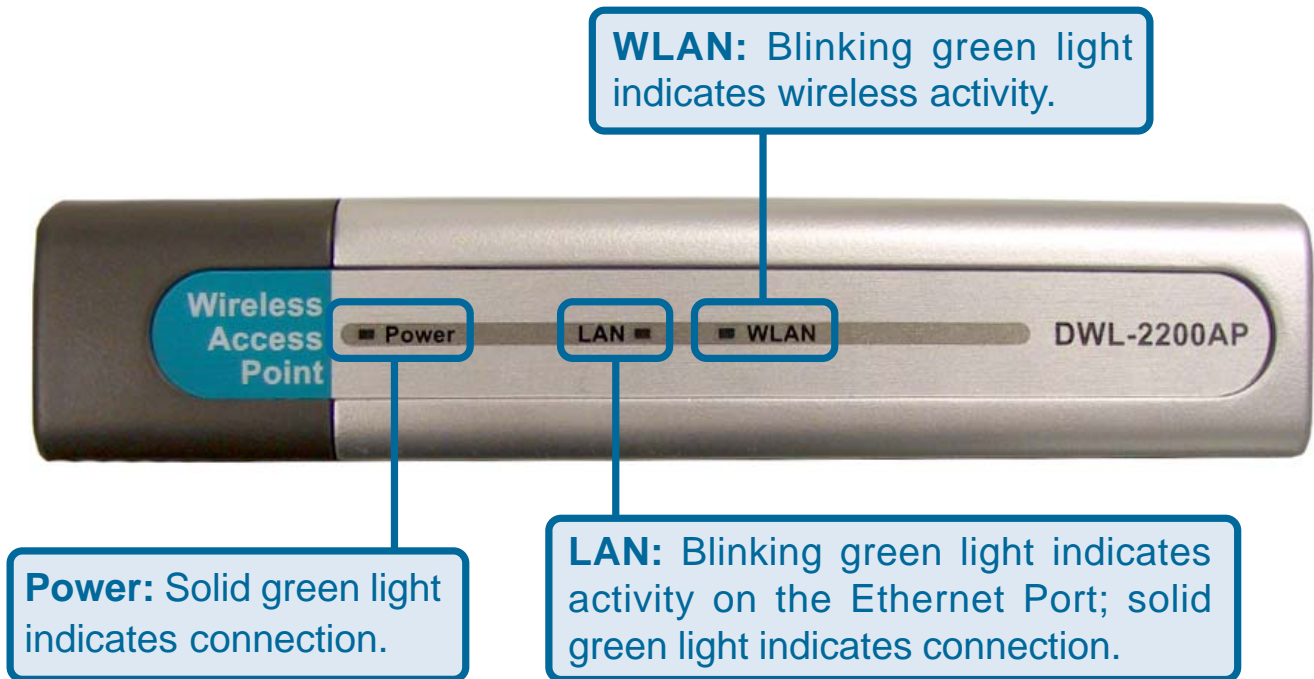

# Connections

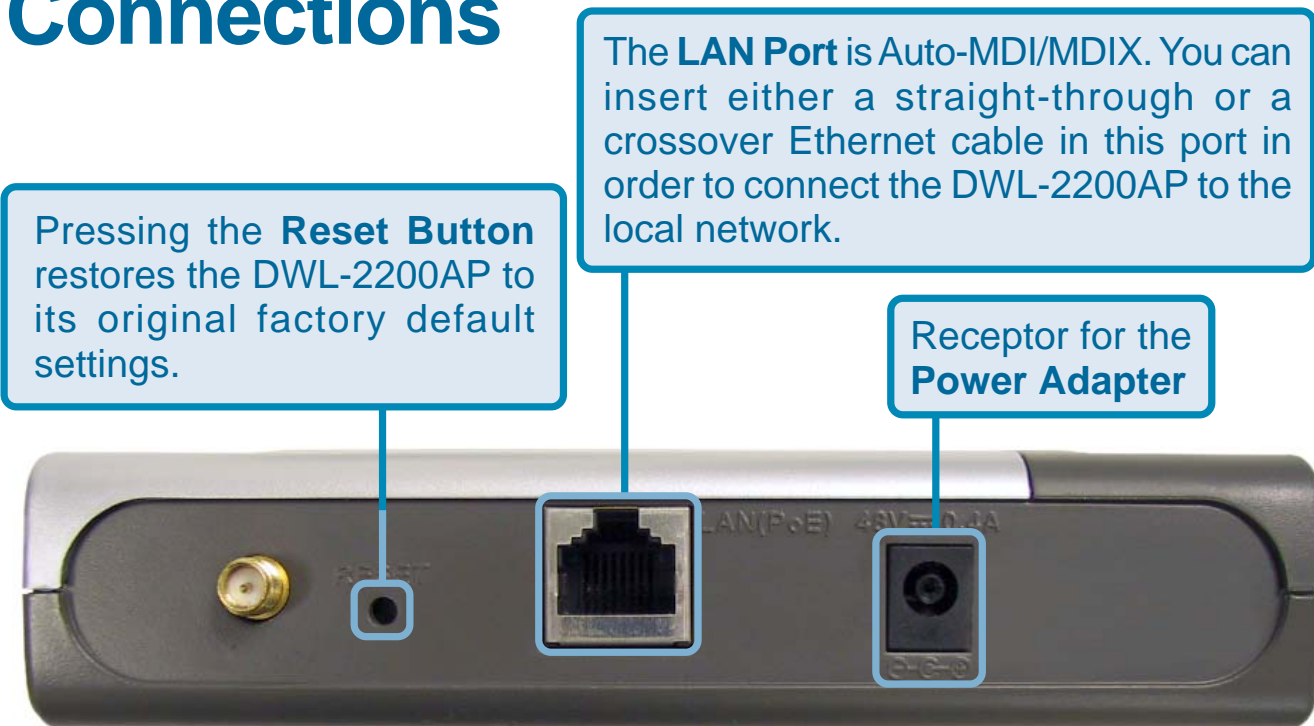

# Features

- **4 Different Operation modes** - Capable of operating in one of four different operation modes to meet your wireless networking requirements: Access Point; AP-to-AP Bridging; AP-to-Multipoint Bridging; or Repeater.
- **Easy Installation with PoE (Power over Ethernet).**
- **Faster wireless networking** with the 802.11g standard to provide a maximum wireless signal rate of up to 54Mbps\* (maximum wireless signal rate of up to 108Mbps\* in Super G mode).
- **Compatible with the 802.11b standard** to provide a wireless data rate of up to 11Mbps - that means you can migrate your system to the 802.11g standard on your own schedule without sacrificing connectivity.
- **Better security with WPA** - The DWL-2200AP can securely connect to wireless clients on the network using WPA (Wi-Fi Protected Access) providing a much higher level of security for your data and communications than has previously been available.
- **AP Manager Setup Wizard** - The new Setup Wizard makes network configuration quick and simple.
- **SNMP for Management** - The DWL-2200AP is not just fast but it also supports SNMP v.3 for a better network management. Superior wireless AP manager software is bundled with the DWL-2200AP for network configuration and firmware upgrade. Systems administrators can also setup the DWL-2200AP easily with the Web-based configuration. A D-Link D-View module will be downloadable for network administration and real-time network traffic monitoring with D-Link D-View software.
- Utilizes **OFDM** technology (**O**rthogonal **F**requency **D**ivision **M**ultiplexing).
- Operates in the 2.4GHz frequency range.
- **Web-based interface** for managing and configuring.

\*Maximum wireless signal rate derived from IEEE Standard 802.11g specifications. Actual data throughput will vary. Network conditions and environmental factors lower actual data throughput rate.

# Wireless Basics

D-Link wireless products are based on industry standards to provide easy-to-use and compatible high-speed wireless connectivity within your home, business or public access wireless networks. D-Link wireless products will allow you access to the data you want, when and where you want it. You will be able to enjoy the freedom that wireless networking brings.

A Wireless Local Area Network (WLAN) is a computer network that transmits and receives data with radio signals instead of wires. WLANs are used increasingly in both home and office environments, and public areas such as airports, coffee shops and universities. Innovative ways to utilize WLAN technology are helping people to work and communicate more efficiently. Increased mobility and the absence of cabling and other fixed infrastructure have proven to be beneficial for many users.

Wireless users can use the same applications they use on a wired network. Wireless adapter cards used on laptop and desktop systems support the same protocols as Ethernet adapter cards.

*People use WLAN technology for many different purposes:*

**Mobility** - Productivity increases when people have access to data in any location within the operating range of the WLAN. Management decisions based on real-time information can significantly improve worker efficiency.

**Low Implementation Costs** - WLANs are easy to set up, manage, change and relocate. Networks that frequently change can benefit from WLANs ease of implementation. WLANs can operate in locations where installation of wiring may be impractical.

**Installation and Network Expansion** - Installing a WLAN system can be fast and easy and can eliminate the need to pull cable through walls and ceilings. Wireless technology allows the network to go where wires cannot go - even outside the home or office.

**Inexpensive Solution** - Wireless network devices are as competitively priced as conventional Ethernet network devices. The DWL-2200AP saves money by providing multi-functionality, configurable in one of four different modes.

**Scalability** - WLANs can be configured in a variety of ways to meet the needs of specific applications and installations. Configurations are easily changed and range from Peer-to-Peer networks suitable for a small number of users to larger Infrastructure networks to accommodate hundreds or thousands of users, depending on the number of wireless devices deployed.

# Wireless Basics *(continued)*

## Standards-Based Technology

The DWL-2200AP Wireless Access Point utilizes the **802.11b** and the **802.11g** standards.

The IEEE **802.11g** standard is an extension of the **802.11b** standard. It increases the maximum wireless signal rate of up to 54Mbps\* (maximum wireless signal rate of up to 108Mbps\* in Super G mode) within the 2.4GHz band, utilizing **OFDM technology**.

This means that in most environments, within the specified range of this device, you will be able to transfer large files quickly or even watch a movie in MPEG format over your network without noticeable delays. This technology works by transmitting high-speed digital data over a radio wave utilizing **OFDM (Orthogonal Frequency Division Multiplexing)** technology. **OFDM** works by splitting the radio signal into multiple smaller sub-signals that are then transmitted simultaneously at different frequencies to the receiver. **OFDM** reduces the amount of **crosstalk** (interference) in signal transmissions. The D-Link DWL-2200AP will automatically sense the best possible connection speed to ensure the greatest speed and range possible.

802.11g offers WPA, the most advanced network security features available today.

\*Maximum wireless signal rate derived from IEEE Standard 802.11g specifications. Actual data throughput will vary. Network conditions and environmental factors lower actual data throughput rate.



# Wireless Basics (*continued*)

## Installation Considerations

The D-Link *AirPremier* DWL-2200AP lets you access your network, using a wireless connection, from virtually anywhere within its operating range. Keep in mind, however, that the number, thickness and location of walls, ceilings, or other objects that the wireless signals must pass through, may limit the range. Typical ranges vary depending on the types of materials and background RF (radio frequency) noise in your home or business. The key to maximizing wireless range is to follow these basic guidelines:

- 1** Keep the number of walls and ceilings between the DWL-2200AP and other network devices to a minimum - each wall or ceiling can reduce your DWL-2200AP's range from 3-90 feet (1-30 meters.) Position your devices so that the number of walls or ceilings is minimized.
- 2** Be aware of the direct line between network devices. A wall that is 1.5 feet thick (.5 meters), at a 45-degree angle appears to be almost 3 feet (1 meter) thick. At a 2-degree angle it looks over 42 feet (14 meters) thick! Position devices so that the signal will travel straight through a wall or ceiling (instead of at an angle) for better reception.
- 3** Building materials can impede the wireless signal - a solid metal door or aluminum studs may have a negative effect on range. Try to position wireless devices and computers with wireless adapters so that the signal passes through drywall or open doorways and not other materials.
- 4** Keep your product away (at least 3-6 feet or 1-2 meters) from electrical devices or appliances that generate RF noise.

# Getting Started

On the following pages we will show you an example of an **Infrastructure Network** incorporating the DWL-2200AP.

An **Infrastructure** network contains an access point or a wireless router. The **Infrastructure Network** example shown on the following page contains the following D-Link network devices (your existing network may be comprised of other devices):

- A wireless access point -  
**D-Link AirPremier™ DWL-2200AP**
- An Ethernet router - **D-Link DI-604**
- A laptop computer with a wireless adapter -  
**D-Link AirPlus Xtreme G™ DWL-G650**
- A desktop computer with a wireless adapter -  
**D-Link AirPlus Xtreme G™ DWL-G520**
- A cable modem - **D-Link DCM-201**

# Getting Started (continued)

## Setting up an example of a Wireless Infrastructure Network



For a typical wireless setup at home (as shown above), you may do the following:

- 1 You will need broadband Internet access (a Cable or DSL-subscriber line into your home or office).
- 2 Consult with your Cable or DSL provider for proper installation of the modem.
- 3 Connect the Cable or DSL modem to the DI-604 Router. (See the printed Quick Installation Guide included with your router.)
- 4 Connect the Ethernet Broadband Router to the PoE base unit. (See the printed Quick Installation Guide included with the DWL-2200AP.)
- 5 Connect the DWL-2200AP to the PoE base unit. (See the printed Quick Installation Guide included with the DWL-2200AP.)
- 6 If you are connecting a desktop computer to your network, install the D-Link DWL-G520 wireless PCI adapter into an available PCI slot on your desktop computer.  
(See the printed Quick Installation Guide included with the network adapter.)
- 7 Install the drivers for the D-Link DWL-G650 wireless Cardbus adapter into a laptop computer.  
(See the printed Quick Installation Guide included with the DWL-G650.)

# Getting Started (continued)

## Connecting PoE (Power over Ethernet)

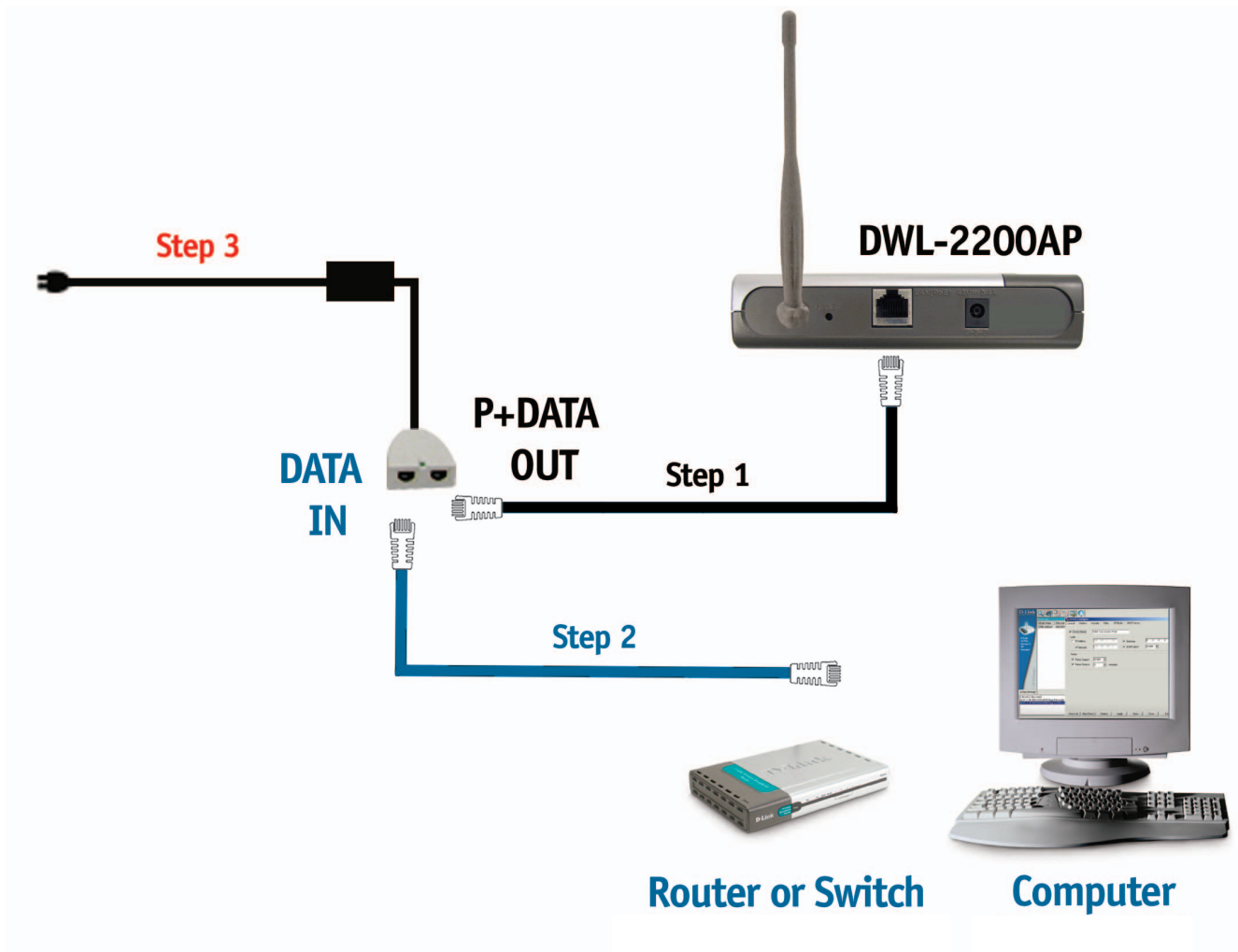

- Step 1** Connect one end of an Ethernet cable (included with your package) to the **LAN port** on the DWL-2200AP and the other end of the Ethernet cable to the port labeled **P+DATA OUT** on the PoE base unit.
- Step 2** Connect another Ethernet cable from the **DATA IN** port on the PoE base unit to your router/switch or to a PC.
- Step 3** Attach the power adapter to the connector labeled **POWER IN** on the PoE base unit. Attach the power cord to the power adapter and into an electrical outlet.

# Using the Configuration Menu

It is recommended that you use an Ethernet connection to configure the DWL-2200AP.

After you have completed the *Setup Wizard* (please see the *Quick Installation Guide* that came with the product) you can access the *Configuration* menu at any time by opening the Web browser and typing in the IP address of the DWL-2200AP. The DWL-2200AP default IP address is shown below:

- Open the Web browser
- Type in the **IP address** of the DWL-2200AP

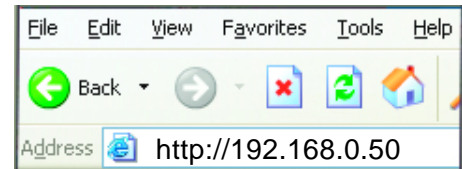

*Note: if you have changed the default IP address assigned to the DWL-2200AP, make sure to enter the correct IP address.*

- Type **admin** in the **User Name** field
- Leave the **Password** blank.  
*(However, if you have changed the password, please enter the correct password.)*
- Click **OK**



## Home > Wizard

The **Home>Wizard** screen will appear. Please refer to the *Quick Installation Guide* for more information regarding the Setup Wizard.

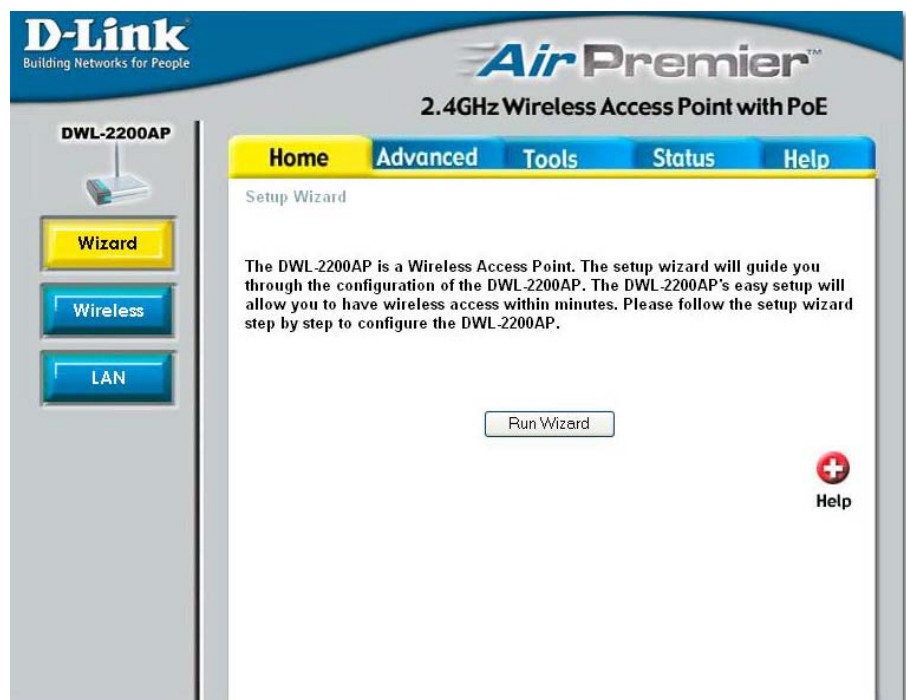

# Using the Configuration Menu (continued)

Home > Wireless

**D-Link**  
Building Networks for People

**Air Premier™**  
2.4GHz Wireless Access Point with PoE

DWL-2200AP

Wizard  
Wireless  
LAN

Home Advanced Tools Status Help

Wireless Settings

Wireless Band: IEEE802.11g  
SSID: default  
SSID Broadcast: Enable  
Channel: 6  
Radio Frequency: 2.437 GHz

Apply Cancel Help

## Wireless

**Band-** 802.11g.

## SSID-

Service Set Identifier (SSID) is the name designated for a specific wireless local area network (WLAN). The SSID's factory default setting is **default**. The SSID can be easily changed to connect to an existing wireless network or to establish a new wireless network.

## SSID

**Broadcast-** Enable or Disable SSID Broadcast. Enabling this feature broadcasts the SSID across the network.

## Channel-

**6** is the default channel. All devices on the network must share the same channel.

## Radio

**Frequency-** The radio frequency will remain at 2.437GHz .

## Apply-

Click **Apply** to save the changes.



# Using the Configuration Menu (continued)

Home > LAN

The screenshot shows the configuration interface for a D-Link DWL-2200AP. The page title is "Air Premier™ 2.4GHz Wireless Access Point with PoE". The navigation menu includes "Home", "Advanced", "Tools", "Status", and "Help". The "LAN Settings" section is active, showing the following configuration:

Field	Value
Get IP From	Static (Manual)
IP address	192.168.0.50
Subnet Mask	255.255.255.0
Default Gateway	0.0.0.0

At the bottom right of the configuration area, there are three buttons: "Apply" (with a green checkmark icon), "Cancel" (with an orange 'x' icon), and "Help" (with a red plus icon).

LAN is short for Local Area Network. This is considered your internal network. These are the IP settings of the LAN interface for the DWL-2200AP. These settings may be referred to as private settings. You may change the LAN IP address if needed. The LAN IP address is private to your internal network and cannot be seen on the Internet.

- Get IP From-** Select **Static (Manual)** or **Dynamic (DHCP)** as the method you will use to assign an IP address to the DWL-2200AP.
- IP Address-** The IP address of the LAN interface.  
The default IP address is: **192.168.0.50**
- Subnet Mask-** The subnet mask of the LAN interface.  
The default subnet mask is **255.255.255.0**
- Default Gateway-** This field is optional. Enter in the IP address of the router on your network.
- Apply-** Click **Apply** to save the changes.

# Using the Configuration Menu (continued)

The DWL-2200AP can be configured to perform in any of four modes: a Wireless Access Point; a Wireless Bridge; a Multi-Point Bridge; or a Repeater.

**Access Point** - This is the default setting. This mode is used to create a wireless LAN.

**PtP Bridge** - Allows you to connect two LANs together. The wireless bridge will only work with another DWL-2200AP. Click to enable and enter the MAC address of the remote bridge.

**PtMP Bridge** - Allows you to connect multiple wireless LANs together. Other wireless LANs must be using DWL-2200APs. Click to enable, and enter up to 8 remote AP MAC addresses.

**AP Repeater** - Allows you to repeat the wireless signal of the root AP. Click to enable and enter the MAC address of the root AP.

**SSID** - The SSID setting is **default**.

Click **Site Survey** to see the configuration of the devices on the network.

When you **Double-click** the device you wish to connect to, the MAC/SSID info will be copied into the correct input boxes.

**Apply** - Click **Apply** if you have made any changes.

Find the **MAC address** of the DWL-2200AP that is acting as a **Remote Access Point** or a **Remote Bridge**, by going to **Status > Device Info** in the configuration utility of the remote DWL-2200AP. There you will find the MAC address.

## **MAC Address** - Media Access Control Address

A unique hardware address that identifies a device on a network. It is assigned at the factory and cannot be changed. Usually you will find this address on a sticker on the device or on the packaging.

## Advanced > Mode

The screenshot shows the D-Link Air Premier configuration utility for a DWL-2200AP. The interface is titled "D-Link Building Networks for People" and "Air Premier 2.4GHz Wireless Access Point with PoE". The "Advanced" tab is selected, and the "Mode" sub-tab is active. On the left, there is a sidebar with buttons for "Mode", "Performance", "Filters", "Encryption", and "DHCP Server". The main area shows configuration options for the mode:

- Wireless Band: IEEE802.11g
- Access Point:
- PtP Bridge:
- Remote AP MAC Address:
- PtMP Bridge:
- Remote AP MAC Address:
  - 1:
  - 2:
  - 3:
  - 4:
  - 5:
  - 6:
  - 7:
  - 8:
- AP Repeater:
- Root AP MAC Address:
- SSID:

At the bottom right, there are three icons: a green checkmark, a red X, and a red plus sign, with the labels "Apply", "Cancel", and "Help" respectively. Below the main configuration area, there is a "Site Survey" section with a "Site Survey" button and a table with columns: BSS Type, Channel, RSSI, BSSID, SECURITY, and SSID.



# Using the Configuration Menu (continued)

## Advanced > Performance

### Wireless Band-

Select **802.11g only** or **802.11g and 802.11b**.

### Frequency-

The frequency remains at **2.437GHz**.

### Channel-

Select from channels **1-11**.

### Data Rate\*-

The maximum wireless signal rates are Auto, 1Mbps, 2Mbps, 5.5Mbps, 6Mbps, 9Mbps, 11Mbps, 12Mbps, 18Mbps, 24Mbps, 36Mbps, 48Mbps, 54Mbps.



**Beacon Interval-** Beacons are packets sent by an access point to synchronize a network. Specify a beacon interval value. The default (100) is recommended.

**DTIM-** (*Delivery Traffic Indication Message*)- **3** is the default setting. DTIM is a countdown informing clients of the next window for listening to broadcast and multicast messages.

**Fragment Length-** The fragmentation threshold, which is specified in bytes, determines whether packets will be fragmented. Packets exceeding the 2346 byte setting will be fragmented before transmission. 2346 is the default setting.

**RTS Length-** This value should remain at its default setting of 2,346. If you encounter inconsistent data flow, only minor modifications to the value range between 256 and 2,346 are recommended.

**Transmit Power-** Choose full, half (-3dB), quarter (-6dB), eighth (-9dB), minimum power.

**Super G Mode-** Super G is a group of performance enhancement features that increase end user application throughput in an 802.11g network. Super G is backwards compatible to standard 802.11g devices. For top performance, all wireless devices on the network should be Super G capable. Select either Disabled, Super G without Turbo, Super G with Dynamic Turbo, or Super G with Static Turbo.

**Disabled-** Standard 802.11g support, no enhanced capabilities.

**Super G without Turbo-** Capable of Packet Bursting, FastFrames, Compression, and no Turbo mode.

\*Maximum wireless signal rate derived from IEEE Standard 802.11g and IEEE Standard 802.11b specifications. Actual data throughput will vary. Network conditions and environmental factors lower actual data throughput rate.

# Using the Configuration Menu (continued)

## Advanced > Performance (continued)

### Super G with Dynamic Turbo-

Capable of Packet Bursting, FastFrames, Compression, and Dynamic Turbo. This setting is backwards compatible with non-Turbo (legacy) devices. Dynamic Turbo mode is only enabled when all devices on the wireless network are configured with Super G with Dynamic Turbo enabled.

### Super G with Static Turbo-

Capable of Packet Bursting, FastFrames, Compression, and Static Turbo. This setting is not backwards compatible with non-Turbo (legacy) devices. Static turbo mode is always on and is only enabled when all the devices on the wireless network are configured with Super G with Static Turbo enabled.

### 802.11g only-

For increased speed in your network, enable this option. 802.11b devices will be excluded.

### Radio Wave-

Select ON or OFF.

### Auto Channel Scan-

Select Enable or Disable. (Enable this feature to auto-select the channel for best wireless performance.)

## Advanced > Filters > Wireless Access Settings

### Wireless Band- IEEE802.11g



The following fields are available for configuration in this window:

### Access Control-

Select **Disabled** to disable the filters function.  
Select **Accept** to accept only those devices with MAC addresses in the Access Control List.  
Select **Reject** to reject the devices with MAC addresses in the Access Control List.

### MAC Address-

Enter the MAC addresses of the devices to which you wish to apply Access Control.

### Apply-

Click **Apply** to save the changes

# Using the Configuration Menu (continued)

## Advanced > Filters > WLAN Partition



**Wireless Band-**

IEEE 802.11g

**Internal Station Connection-**

Enabling this feature allows wireless clients to communicate with each other. If this feature is disabled, wireless stations of the selected band are not allowed to exchange data through the access point.

**Ethernet to WLAN Access-**

Enabling this feature allows Ethernet devices to communicate with wireless clients. If this feature is disabled, all data from the Ethernet to associated wireless devices is blocked, but wireless devices can still send data to the Ethernet.

# Using the Configuration Menu (continued)

## Advanced > Encryption > Open System and/or Shared Key

When you select **Open System**, **Shared Key** or **Open System/Shared Key**, enter values for the fields that are shown here highlighted in blue.

### Wireless Band-

802.11g.

### Authentication-

Select **Open System** to communicate the key across the network.

Select **Shared Key** to limit communication to only those devices that share the same WEP settings.

Select **Open System/Shared Key** to communicate the key and require identical WEP settings to communicate.

### Encryption-

Select **Disabled** or **Enabled**.

### Key Type-

Select **HEX** or **ASCII**.

### Key Size-

Select **64-**, **128-**, **152-**bits.

### Valid Key-

Select the **1st** through the **4th** key to be the active key.

### First through Fourth keys-

Input up to **four keys** for encryption. You will select one of these keys in the valid key field.

### Apply-

Click **Apply** to save changes.

The screenshot shows the configuration interface for a D-Link Air Premier 2.4GHz Wireless Access Point. The 'Advanced' tab is active, and the 'Security Settings' section is highlighted in blue. The 'Encryption' section is expanded, showing the following settings: Authentication is set to 'Open System' (selected), Cipher Type is 'WEP', and Encryption is 'Enabled'. The 'Key Type' is 'HEX' and 'Key Size' is '64 Bits'. The 'Valid Key' is set to 'First'. There are four input fields for 'First Key', 'Second Key', 'Third Key', and 'Fourth Key'. The 'Apply', 'Cancel', and 'Help' buttons are visible at the bottom right.

**Hexadecimal** digits consist of the numbers 0-9 and the letters A-F

**ASCII** (American Standard Code for Information Interchange) is a code for representing English letters as numbers from 0-127



# Using the Configuration Menu (continued)

## Advanced > Encryption > WPA-EAP

When you select **WPA-EAP**, you will configure the following properties.

### Cipher Type-

When you select **WPA-EAP**, you must select **AES**, **AUTO** or **TKIP** from the pull down menu.

### Group Key Update Interval-

Select the interval during which the group key will be valid. 1800 is the recommended value. A lower interval may reduce data transfer rate.

### Radius Server-

Enter the IP address of the Radius server.

### Radius Port-

Enter the Radius port.

### Radius Secret-

Enter the the Radius secret.

### Encryption-

Select **Enabled**.

### Apply-

Click **Apply** to save changes.

The screenshot shows the configuration interface for a D-Link Air Premier 2.4GHz Wireless Access Point with PoE. The page is titled "D-Link Building Networks for People" and "Air Premier™ 2.4GHz Wireless Access Point with PoE". The navigation tabs are "Home", "Advanced", "Tools", "Status", and "Help". The "Advanced" tab is selected, and the "Security Settings" section is active. The "Wireless Band" is set to "IEEE802.11g". Under "Authentication", "WPA-EAP" is selected. The "PassPhrase" field is empty. The "Cipher Type" dropdown menu is open, showing "AES" selected, with "Auto" and "TKIP" also visible. The "Group Key Update Interval" is set to "1800". The "Radius Server" field is empty. The "Radius Port" is set to "1812". The "Radius Secret" field is empty. Under "Encryption", "Enabled" is selected. The "Key Type" is set to "HEX" and the "Key Size" is "64 Bits". The "Key Table" section has a "Valid Key" dropdown set to "First" and four empty text boxes for "First Key", "Second Key", "Third Key", and "Fourth Key". At the bottom right, there are three buttons: "Apply" (green checkmark), "Cancel" (orange X), and "Help" (red plus).

# Using the Configuration Menu (continued)

## Advanced > Encryption > WPA-PSK

### Pass Phrase-

When you select **WPA-PSK**, you must enter a **PassPhrase** in the corresponding field.

### Cipher Type-

When you select **WPA-PSK**, you must select **AES**, **AUTO** or **TKIP** from the pull down menu.

### Group Key Update Interval-

Select the interval during which the group key will be valid. The default value of 1800 is recommended.

### Encryption-

Select **Enabled**.

The screenshot shows the configuration interface for a D-Link Air Premier 2.4GHz Wireless Access Point with PoE. The page is titled "Advanced > Encryption > WPA-PSK". The interface includes a navigation menu with "Home", "Advanced", "Tools", "Status", and "Help". The "Advanced" tab is selected. The "Security Settings" section is active, showing the following configuration:

- Wireless Band: IEEE802.11g
- Authentication:  Open System,  Shared Key,  Open System / Shared key,  WPA-EAP,  WPA-PSK
- PassPhrase: [Empty text field]
- Cipher Type: [AES selected in dropdown menu]
- Group Key Update Interval: 1800
- Radius Server: [Empty text field]
- Radius Port: 1812
- Radius Secret: [Empty text field]
- Encryption:  Disabled,  Enabled
- Key Type: HEX
- Key Size: 64 Bits
- Key Table: [First selected in dropdown menu]
- Valid Key: [Empty text field]
- First Key: [Empty text field]
- Second Key: [Empty text field]
- Third Key: [Empty text field]
- Fourth Key: [Empty text field]

At the bottom right, there are three buttons: "Apply" (green checkmark), "Cancel" (orange X), and "Help" (red plus).

**Apply-** Click **Apply** to save changes.

# Using the Configuration Menu (continued)

## Advanced > DHCP Server > Dynamic Pool Settings

**DHCP Server Control-**  
Enable or Disable the DHCP function here.

### Dynamic Pool Settings

### IP Assigned From-

Input the first IP address available for assignment in your network.

### The Range of Pool (1-255)-

Enter the number of IP addresses that are available for assignment.

The screenshot shows the configuration interface for a D-Link DWL-2200AP. The page title is "Air Premier 2.4GHz Wireless Access Point with PoE". The navigation tabs are "Home", "Advanced", "Tools", "Status", and "Help". The "Advanced" tab is selected, and the sub-menu is "Dynamic Pool Settings". The "DHCP Server Control" section has "Function Enable/Disable" set to "Disabled". The "Dynamic Pool Settings" section includes fields for "IP Assigned From" (0.0.0.0), "The Range of Pool (1-255)" (0), "SubMask" (0.0.0.0), "Gateway" (0.0.0.0), "Wins" (0.0.0.0), "DNS" (0.0.0.0), "Domain Name", "Lease Time (60 - 31536000 sec)" (0), and "Status" (OFF). At the bottom right, there are "Apply", "Cancel", and "Help" buttons.

### SubMask-

Enter the subnet mask.

### Gateway-

Enter the IP address of the router on the network.

### Wins-

**Windows Internet Naming Service** is a system that determines the IP address of a network computer that has a dynamically assigned IP address.

### DNS-

Enter the IP address of the DNS server. The DNS server translates domain names such as [www.dlink.com](http://www.dlink.com) into IP addresses.

### Domain Name-

Enter the Domain Name of the DWL-2200AP.

### Lease Time (60-31536000 sec)-

The **Lease Time** is the period of time before the DHCP server will assign a new IP address.

### Status-

Turn the **Dynamic Pool Settings** ON or OFF here.

### Apply-

Click **Apply** if you have made any changes.

# Using the Configuration Menu (continued)

## Advanced > DHCP Server > Static Pool Settings

**DHCP Server Control-**  
Enable or Disable the DHCP function here.

### Static Pool Settings

**Assigned IP-**  
Enter the static IP address of the device here.

**Assigned MAC Address-**  
Enter the MAC address of the device here.

**SubMask-**  
Enter the subnet mask here.

**Gateway-**  
Enter the IP address of the router on the network.

**Wins-**  
**Windows Internet Naming Service** is a system that determines the IP address of the a network computer that has a dynamically assigned IP address.

**DNS-**  
Enter the IP address of the DNS server. The DNS server translates domain names such as www.dlink.com into IP addresses.

**Domain Name-**  
Enter the **Domain Name** of the DWL-2200AP.

**Status-**  
Turn the **Static Pool Settings ON or OFF** here.

### Assigned Static Pool

After you have input the **Static Pool Settings** for each device, click **Apply** and the profile will appear in this list at the bottom of the window.

The screenshot shows the configuration interface for a D-Link DWL-2200AP. The page title is "Air Premier 2.4GHz Wireless Access Point with PoE". The navigation menu includes Home, Advanced (selected), Tools, Status, and Help. The breadcrumb trail is "Static Pool Settings / Current IP Mapping List / Dynamic Pool Settings".

**DHCP Server Control**  
Function Enable/Disable: Disabled

**Static Pool Settings**

Assigned IP	0.0.0.0
Assigned MAC Address	
SubMask	0.0.0.0
Gateway	0.0.0.0
Wins	0.0.0.0
DNS	0.0.0.0
Domain Name	
Status	OFF

Buttons: Apply (green checkmark), Cancel (orange X), Help (red plus).

**Assigned Static Pool**

MAC Address	IP address	State	Edit	Delete
-------------	------------	-------	------	--------



# Using the Configuration Menu (continued)

## Advanced > DHCP Server > Current IP Mapping List

The screenshot shows the configuration interface for a D-Link DWL-2200AP. The top navigation bar includes 'Home', 'Advanced' (selected), 'Tools', 'Status', and 'Help'. The left sidebar contains buttons for 'Mode', 'Performance', 'Filters', 'Encryption', and 'DHCP Server' (highlighted in yellow). The main content area is titled 'Current IP Mapping List' and includes links for 'Dynamic Pool Settings' and 'Static Pool Settings'. It features two tables: 'Current DHCP Dynamic Pools' with columns for 'Binding MAC Address', 'Assigned IP address', and 'Lease time'; and 'Current DHCP Static Pools' with columns for 'Binding MAC Address' and 'Assigned IP address'. Both tables are currently empty.

This screen displays information about the current DHCP dynamic and static IP address pools. This information is available when you enable the DHCP function of the DWL-2200AP and assign dynamic and static IP address pools.

**Current DHCP Dynamic Pools**-These are IP address pools to which the DHCP server function has assigned dynamic IP addresses.

**Binding MAC address-** The MAC address of a device on the network that is within the DHCP dynamic IP address pool.

**Assigned IP address-** The current corresponding DHCP-assigned dynamic IP address of the device.

**Lease Time-** The length of time that the dynamic IP address will be valid.

**Current DHCP Static Pools**-These are IP address pools to which the DHCP server function has assigned static IP addresses.

**Binding MAC address-** The MAC address of a device on the network that is within the DHCP static IP address pool.

**Assigned IP address-** The current corresponding DHCP-assigned static IP address of the device.

# Using the Configuration Menu (continued)

## Tools > Admin

The screenshot shows the configuration interface for a D-Link DWL-2200AP. The page title is "Air Premier™ 2.4GHz Wireless Access Point with PoE". The navigation tabs are "Home", "Advanced", "Tools" (selected), "Status", and "Help". On the left sidebar, there are buttons for "Admin" (highlighted in yellow), "System", "Firmware", "Cfg File", and "Misc.". The main content area is titled "Administrator Settings" and contains four input fields: "User Name" (with "admin" entered), "Old Password", "New Password", and "Confirm New Password". At the bottom right of the form, there are three icons: a green checkmark for "Apply", an orange 'X' for "Cancel", and a red plus sign for "Help".

**User Name-** Enter a user name; **admin** is the default setting.

**Old Password-** To change your password, enter your old password here.

**New Password-** Enter your new password here.

**Confirm New Password-** Enter your new password again.

# Using the Configuration Menu (continued)

## Tools > System

### Apply Settings and Restart-

Click **Restart** to apply the system settings and restart the DWL-2200AP.

### Restore to Factory Default Settings-

Click **Restore** to return the DWL-2200AP to its factory default settings.

The screenshot shows the configuration interface for a D-Link Air Premier 2.4GHz Wireless Access Point with PoE. The page title is "D-Link Building Networks for People Air Premier™ 2.4GHz Wireless Access Point with PoE". The navigation tabs are "Home", "Advanced", "Tools", "Status", and "Help", with "Tools" selected. On the left sidebar, there are buttons for "Admin", "System", "Firmware", "Cfg File", and "Misc.", with "System" highlighted. The main content area is titled "System Settings" and contains two sections: "Apply Settings and Restart" with a "Restart" button, and "Restore to Factory Default Settings" with a "Restore" button. A "Help" icon is visible in the bottom right corner.

## Tools > Firmware

### Update File-

After you have downloaded the most recent version of the firmware from [www.support.dlink.com](http://www.support.dlink.com) you can **browse** your hard drive to locate the downloaded file and click **OK** to update the firmware.

The screenshot shows the configuration interface for a D-Link Air Premier 2.4GHz Wireless Access Point with PoE, specifically the "Tools > Firmware" section. The page title is "D-Link Building Networks for People Air Premier™ 2.4GHz Wireless Access Point with PoE". The navigation tabs are "Home", "Advanced", "Tools", "Status", and "Help", with "Tools" selected. On the left sidebar, there are buttons for "Admin", "System", "Firmware", "Cfg File", and "Misc.", with "Firmware" highlighted. The main content area is titled "Update Firmware From Local Hard Drive" and shows "Firmware Version: v1.00". There is an "Update File" label followed by a text input field, a "Browse..." button, and an "OK" button. A "Help" icon is visible in the bottom right corner.

# Using the Configuration Menu (continued)

## Tools > Cfg File

**Update File-**  
**Browse** for the configuration settings that you have saved to your hard drive. Click **OK** after you make your selection.

### Load Settings to the Local Hard Drive-

Click **OK** to load the selected settings.

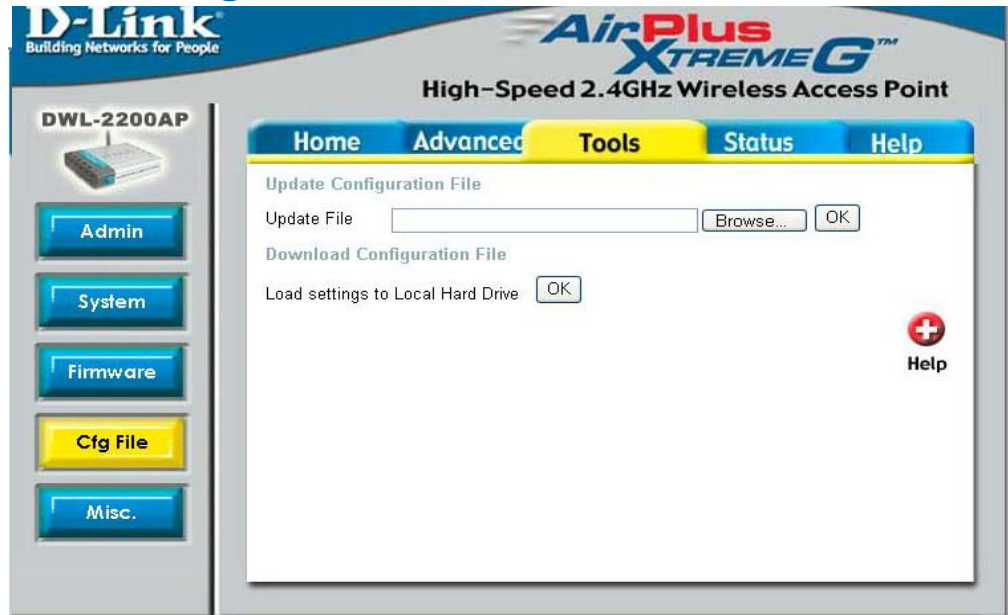

## Tools > Misc.

### Telnet Settings

#### Status-

Click to Enable a Telnet session.

#### Timeout-

Select a time period after which a session timeout will occur.

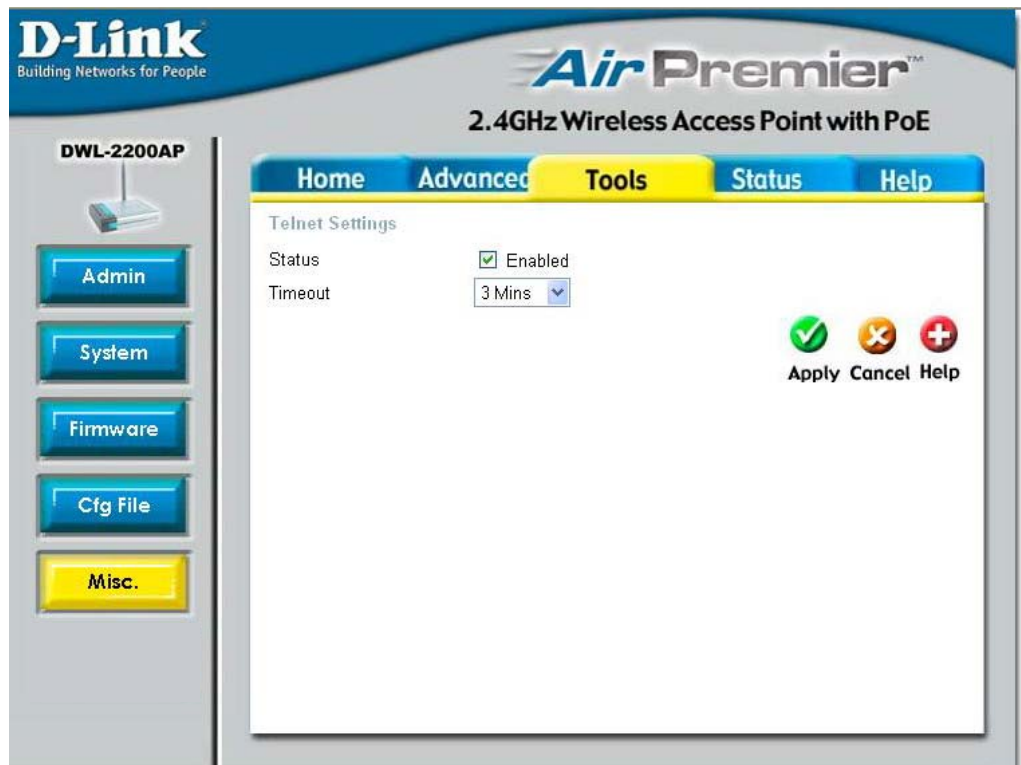

Telnet is a program that allows you to control your network from a single PC.



# Using the Configuration Menu (continued)

## Status > Device Info

This window displays the settings of the DWL-2200AP, as well as the Firmware version, and the MAC address.

The screenshot shows the D-Link Air Premier configuration interface. The top navigation bar includes 'Home', 'Advanced', 'Tools', 'Status' (highlighted), and 'Help'. The left sidebar contains 'Device Info' (highlighted), 'Stats', and 'Client Info'. The main content area displays the following information:

**Device Information**

Firmware Version: v1.00  
MAC Address: 00:0d:88:e6:e9:e9

**Ethernet**

Get IP From:	Manual
IP address:	192.168.0.50
Subnet Mask:	255.255.255.0
Gateway:	0.0.0.0

**Wireless (802.11g)**

SSID:	default
Channel:	6
Super G Mode:	Disabled
Rate:	Auto
Security Level:	Open System / Encryption Disabled

A red plus icon labeled 'Help' is located in the bottom right corner.

## Status > Stats

This window displays the statistics of the wireless local area network.

The screenshot shows the D-Link Air Premier configuration interface. The top navigation bar includes 'Home', 'Advanced', 'Tools', 'Status' (highlighted), and 'Help'. The left sidebar contains 'Device Info', 'Stats' (highlighted), and 'Client Info'. The main content area displays the following statistics:

**WLAN 802.11G Traffic Statistics**

**ThroughPut**

Transmit Success Rate	74 %
Transmit Retry Rate:	68 %
Receive Success Rate:	100 %
Receive Duplicate Rate:	0 %
RTS Success Count:	45216
RTS Failure Count:	5

**Transmitted Frame Count**

Transmitted Frame Count	1554
Multicast Transmitted Frame Count	771
Transmitted Error Count:	548
Transmitted Total Retry Count:	3321
Transmitted Multiple Retry Count:	3321

**Received Frame Count**

Received Frame Count	771
Multicast Received Frame Count	0
Received Frame FCS Error Count:	5
Received Frame Duplicate Count:	0
Ack Rcv failure Count:	0

**Wep Frame Error Count**

WEP Excluded Frame Count	551
WEP ICV Error Count	0

Refresh and Help icons are located in the bottom right corner.

# Using the Configuration Menu (continued)

## Status > Client Info

Client info is listed here.

The screenshot shows the configuration interface for a D-Link DWL-2200AP. The page title is "Air Premier™ 2.4GHz Wireless Access Point with PoE". The navigation menu includes Home, Advanced, Tools, Status, and Help. The "Status" tab is selected, and the "Client Info" sub-tab is active. The "Client Information" section shows 1 station(s) connected. A table lists the client's details:

MAC	Band	Authentication	RSSI(%)	Power Saving Mode
00:13:86:e6:2a:1f	B	Open System	35	Off

## Help

At this window you can access the help screens for the topics listed.

The screenshot shows the "Help" section of the configuration interface. The navigation menu includes Home, Advanced, Tools, Status, and Help. The "Help" tab is selected. The content is organized into sections:

- Home**
  - [Setup Wizard](#)
  - [Wireless](#)
  - [LAN Settings](#)
- Advanced**
  - [Mode](#)
  - [Performance](#)
  - [Filters](#)
  - [Encryption](#)
  - [DHCP](#)
- Tools**
  - [Administrator Settings](#)
  - [System Settings](#)
  - [Firmware Upgrade](#)
  - [Configuration File](#)
  - [Misc.](#)
- Status**
  - [Device Information](#)
  - [Statistics](#)
  - [Client Info](#)

# Using the AP Manager

The **AP Manager** is a convenient tool to manage the configuration of your network from a central computer. With **AP Manager** there is no need to configure devices individually.

To launch the **AP Manager**:

- Go to the **Start Menu**
- Select **All Programs**
- Select **D-Link AirPremier AP Manager**
- Select **DWL-2200AP**

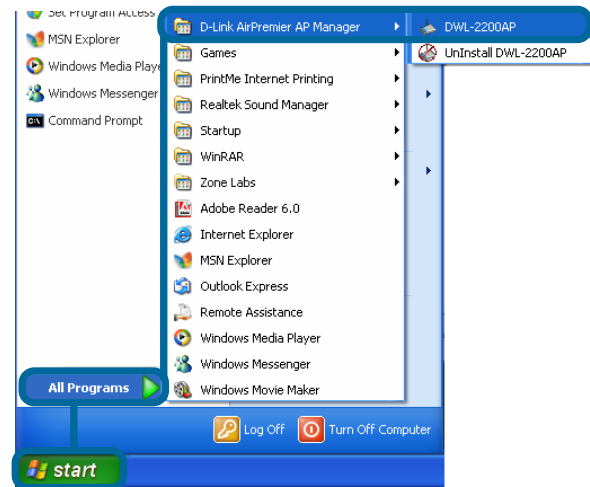

## Discovering Devices



Click on this button to **discover the devices** available on the network.

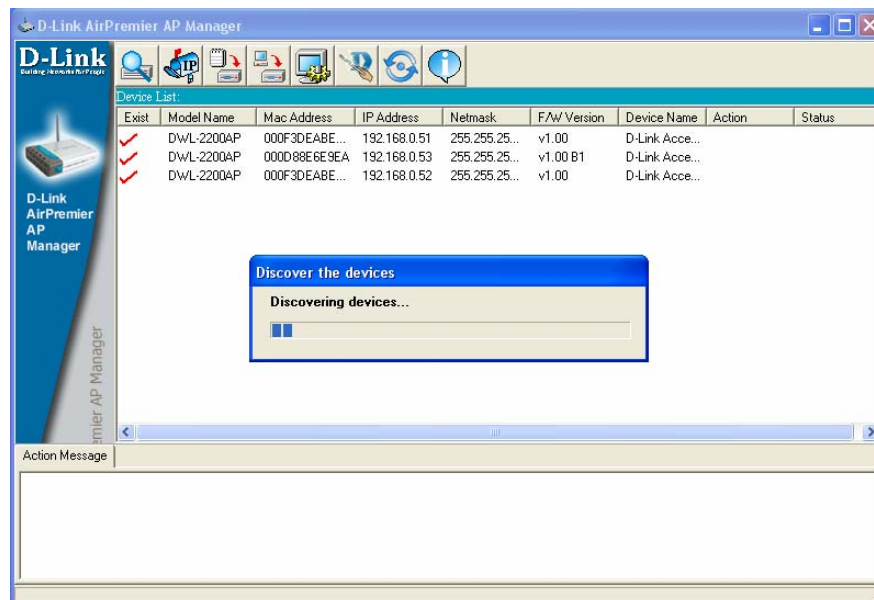

# Using the AP Manager (continued)

## Selecting Devices

The AP Manager allows you to configure multiple devices all at once. To select a single device, simply click on the device you want to select. To select multiple devices, hold down the **Ctrl** key while clicking on each additional device. To select an entire list, hold the **Shift** key, click on the first AP on the list and then click on the last AP on the list.

## IP Configuration



You can assign an IP address to an AP or assign IP addresses to multiple AP's by clicking on this button after selecting the device(s).

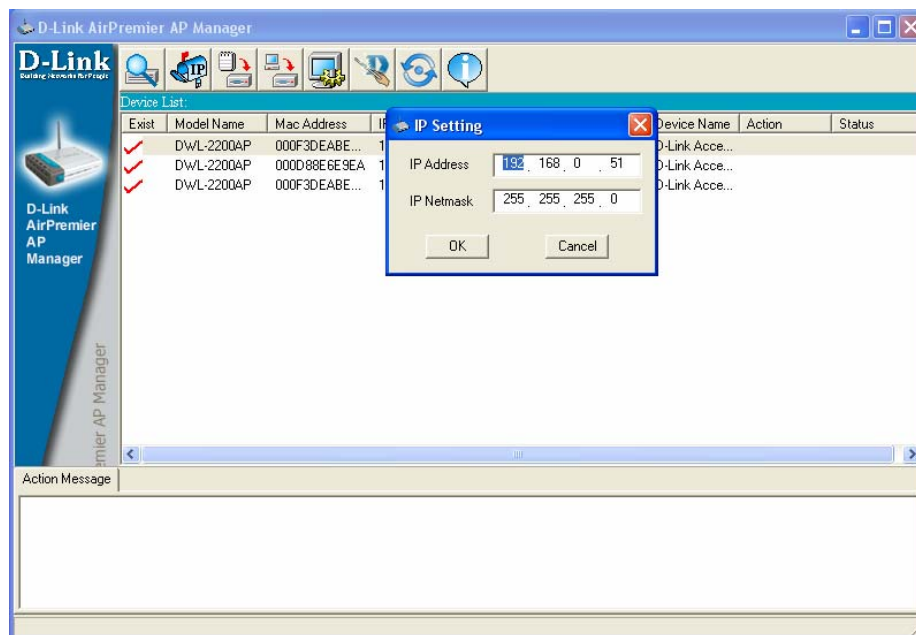

Select the AP that you want to assign an IP address and click the IP button. Enter the IP Address and IP Netmask for the selected device and click OK.

You can configure multiple AP's with IP addresses all at once. Click on the IP button after you've selected all of the AP's you want to assign an IP address. Enter the IP address you want to assign the first unit and the AP manager will automatically assign sequential IP addresses.



# Using the AP Manager (continued)

## Device Configuration

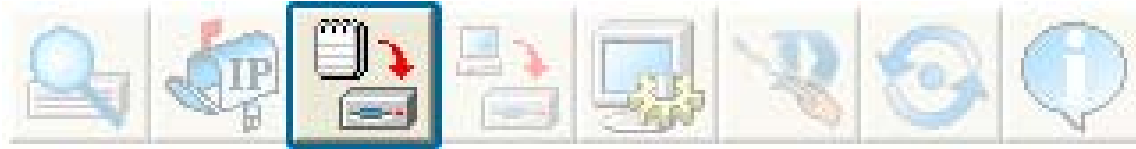

Click on this button to access the configuration properties of the selected device(s).

The device configuration window allows you to configure settings but does not actually apply the settings to the device unless you click the **Apply** button. You can also save and load configuration files from this window. When you load a configuration file, you must click **Apply** if you want the settings to be applied to the selected device(s).

### Check All

The Check All button will select all configurable options. Any setting that has a checkmark next to it is applied to the device or saved to the configuration file.

### Clear Checks

The Clear Checks button deselects all configurable options. This feature is useful if you only want to change a few settings. Deselect all items and only check the items that you want to modify.

### Refresh

Refresh will revert to the actual device settings of the selected device(s).

### Apply

To save settings to the device, you must click the Apply button. Only settings that have a checkmark next to them will be applied.

### Open

The open button is used to load a previously saved configuration file. After opening a configuration file, you must click the Apply button to save the settings to the selected device(s).

### Save

The save button allows you to save a configuration file of the selected device settings. Only settings that have a checkmark next to them are saved. You cannot save a configuration file if you selected more than one device in the device list.

### Exit

The Exit button will close the device configuration window. Any settings that haven't been applied will be lost.

# Using the AP Manager (continued)

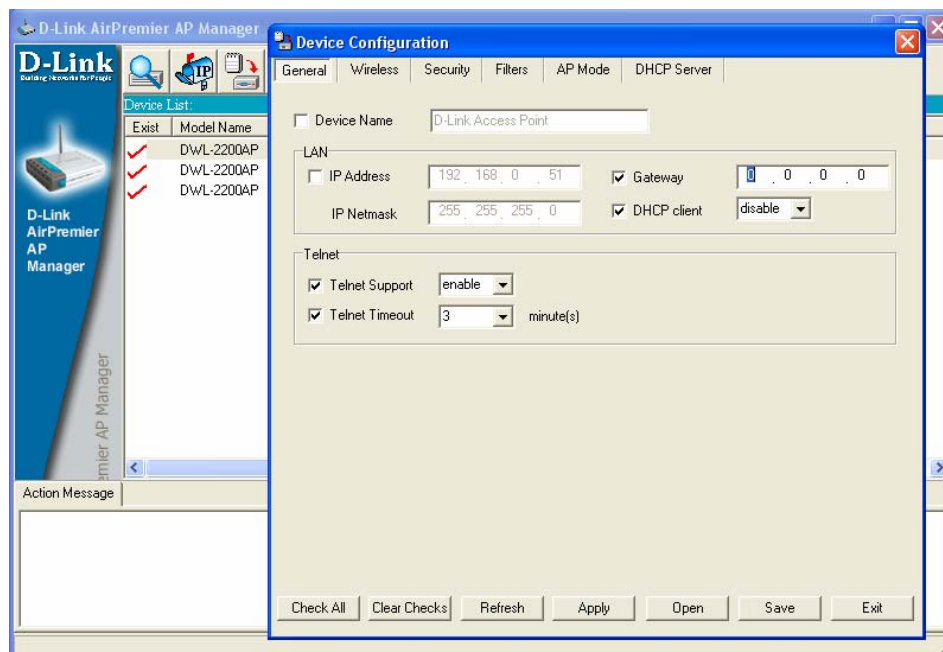
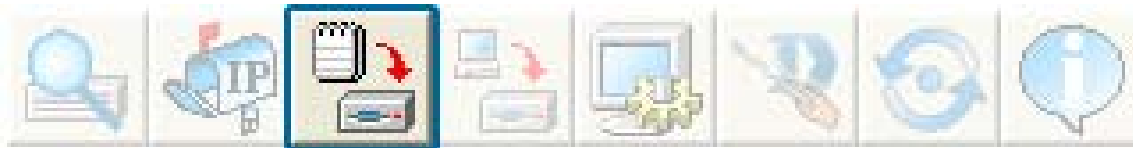

## Device Configuration>General

When selecting multiple devices for configuration, some options are unavailable for configuration as noted(\*) below:

- **Device Name(\*)**: This allows you to change the device name for the selected access point. You must place a checkmark in the Device Name box to change the name. This option can only be configured when one access point is selected for configuration.
- **IP address and Subnet Mask(\*)**: If you've selected one device for configuration and you want to change the IP address of the device, check the IP Address box. You can then enter an IP address and Subnet Mask for the selected access point. This option is only configurable when one access point is selected for configuration. To configure multiple devices with an IP address at one time, please reference the previous page.
- **Gateway**: Enter the IP address of your gateway, typically your router address.
- **DHCP client**: There is a pulldown menu to select enabled or disabled. When enabled, the selected device(s) will function as a DHCP client(s). This allows them to receive IP configuration information from a DHCP server. When disabled, the access point(s) must have a static IP address assigned to them.
- **Telnet Support**: This pulldown selection enables or disables the ability to Telnet into the selected device(s).
- **Telnet Timeout**: This pulldown selection defines the timeout period during a Telnet session with the selected device(s).

# Using the AP Manager (continued)

## Device Configuration>Wireless

- **SSID:** The Service Set (network) Identifier of your wireless network.
- **Channel:** Allows you to select a channel between 1-11.
- **SSID Broadcast:** Allows you to enable or disable the broadcasting of the SSID to network clients.
- **11g only:** When enabled, only 802.11g devices can connect to the selected device(s).
- **Super G:** Super G is a group of performance enhancement features that increase end user application throughput in an 802.11g network. Super G is backwards compatible with standard 802.11g devices. For ideal performance, all wireless devices on the network should be Super G capable. The modes are listed below:

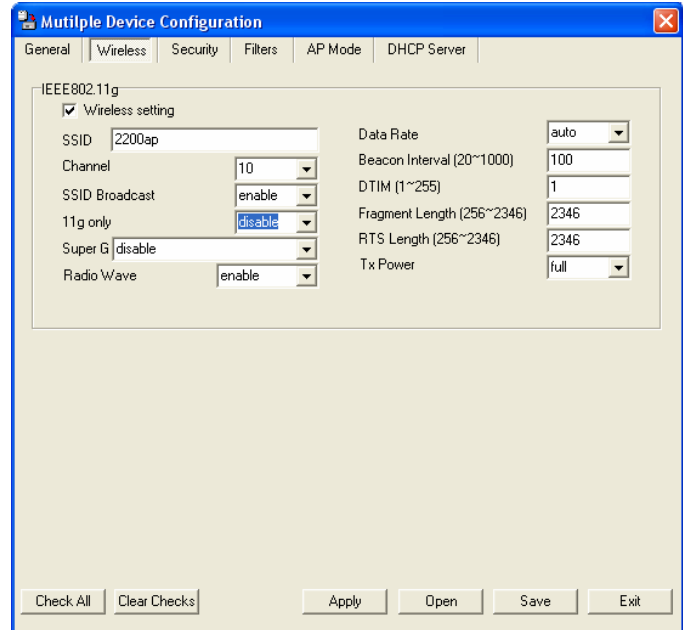

Super G Mode	Function
Disabled	Standard 802.11g support. No enhance
Super G without Turbo	Capable of Packet Bursting, FastFrame
Super G with Dynamic Turbo	Capable of Packet Bursting, FastFrame setting is backwards compatible with nc only enabled when all devices on the wi Dynamic Turbo enabled.
Super G with Static Turbo	Capable of Packet Bursting, FastFrame setting is not backwards compatible wit always on and is only enabled when all with Super G and Static Turbo enabled.

- **Radio Wave:** Enable or disable the wireless functionality of the selected device(s).
- **Data Rate:** A pulldown menu to select the maximum wireless signal rate for the selected devices(s).
- **Beacon Interval (20~1000):** Beacons are packets sent by an access point to synchronize a network. Specify the beacon value for the selected device(s) here. The default value of 100 is recommended.
- **DTIM (1~255):** DTIM (Delivery Traffic Indication Message) is a countdown informing clients of the next listening window for broadcast and multicast messages.
- **Fragment Length (256~2346):** This sets the fragmentation threshold (specified in bytes). Packets exceeding the value set here will be fragmented. The default is 2346.
- **RTS Length (256~2346):** The RTS value should not be changed unless you encounter inconsistent data flow. The default value is 2346.
- **Tx Power:** A pulldown menu for selecting the transmit power of the selected device(s).

# Using the AP Manager (continued)

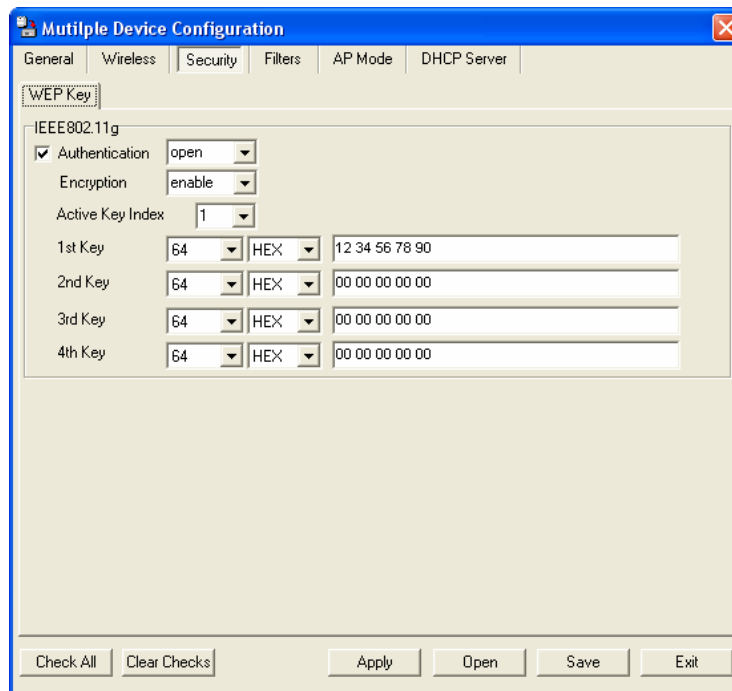

## Device Configuration>Security

The Security tab contains the WEP configuration settings on the initial page. If you select WPA as the authentication type, an additional tab will appear with the WPA configuration options based on your selection.

- **Authentication Type:** Select from the pulldown menu the type of authentication to be used on the selected device(s).

Authentication Type	Function
Open	The key is communicated across the network.
Shared	Limited to communication with devices that share
Open/Shared	The key is communicated and identical WEP sett
WPA-EAP	Used to authenticate clients via a server.
WPA-PSK	Does not utilize a server for authentication but use and access point(s).

- **Encryption:** Enable or disable encryption on the selected device(s).
- **Active Key Index:** Select which defined key is active on the selected device(s).
- **Key Values:** Select the key size (64-bit, 128-bit, or 152-bit) and key type (HEX or ASCII) and then enter a string to use as the key. The key length is automatically adjusted based on the settings you choose.

# Using the AP Manager (continued)

## Device Configuration>Security>WPA-EAP

- **Cipher Type:** Select auto, TKIP, or AES from the pulldown menu.
- **Group Key Update Interval:** Select the interval during which the group key will be valid. 1800 is the recommended setting. A lower interval may reduce transfer rates.
- **RADIUS Server:** Enter the IP address of the RADIUS server.
- **RADIUS Port:** Enter the port used on the RADIUS server.
- **RADIUS Secret:** Enter the RADIUS secret.

The screenshot shows the 'Device Configuration' window with the 'Security' tab selected. The 'Wep Key' is set to 'IEEE802.11g WPA'. The 'WPA setting' section is checked, and the 'Cipher Type' is set to 'auto'. The 'Group Key Update Interval' is set to '1800' (with a range of 300 - 9999999). The 'PassPhrase' field is empty (with a range of 8 - 63 chars). The 'Security Server' section is also visible, with fields for 'RADIUS Server', 'RADIUS Port (0 - 65535)' (set to 1812), and 'RADIUS Secret'. At the bottom, there are buttons for 'Check All', 'Clear Checks', 'Refresh', 'Apply', 'Open', 'Save', and 'Exit'.

## Device Configuration>Security>WPA-PSK

- **Cipher Type:** Select auto, TKIP, or AES from the pulldown menu.
- **Group Key Update Interval:** Select the interval during which the group key will be valid. 1800 is the recommended setting. A lower interval may reduce transfer rates.
- **PassPhrase:** Enter a PassPhrase between 8-63 characters in length .

The screenshot shows the 'Device Configuration' window with the 'Security' tab selected. The 'Wep Key' is set to 'IEEE802.11g WPA'. The 'WPA setting' section is checked, and the 'Cipher Type' is set to 'auto'. The 'Group Key Update Interval' is set to '1800' (with a range of 300 - 9999999). The 'PassPhrase' field is empty (with a range of 8 - 63 chars). The 'Security Server' section is also visible, with fields for 'RADIUS Server', 'RADIUS Port (0 - 65535)', and 'RADIUS Secret'. At the bottom, there are buttons for 'Check All', 'Clear Checks', 'Refresh', 'Apply', 'Open', 'Save', and 'Exit'.

# Using the AP Manager (continued)

## Device Configuration>Filters

- **Internal Station Connection:** Enabling this allows wireless clients to communicate with each other. When this option is disabled, wireless stations are not allowed to exchange data through the access point.
- **Broadcast from Ethernet to WLAN:** Enabling this option allows Ethernet devices to communicate with wireless clients. When this option is disabled, all data from Ethernet to wireless clients is blocked. Wireless devices can still send data to the Ethernet devices when this is disabled.
- **Access Control:** When disabled access control is not filtered based on the MAC address. If Accept or Reject is selected, then a box appears for entering MAC addresses. When **Accept** is selected, only devices with a MAC address in the list are granted access. When **Reject** is selected, devices in the list of MAC addresses are not granted access.

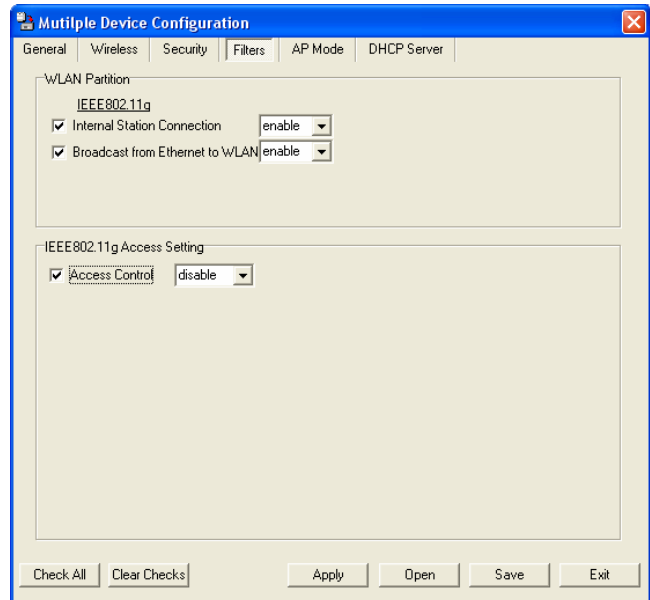

## Device Configuration>AP Mode

- **Normal:** The default setting used to create a wireless LAN.
- **Bridge:** Allows you to connect two wireless LAN's together. This only works with another DWL-2200AP. If enabled you must enter the MAC address of the other DWL-2200AP.
- **Multi-Point Bridge:** Allows you to connect multiple wireless LAN's together. All other LAN's must be using DWL-2200AP's. When enabled, you must enter the MAC address of the other DWL-2200AP's. Enter up to eight addresses.
- **Repeater:** Allows you to repeat the wireless signal of the root access point. When enabled you must enter the MAC address of the root access point.

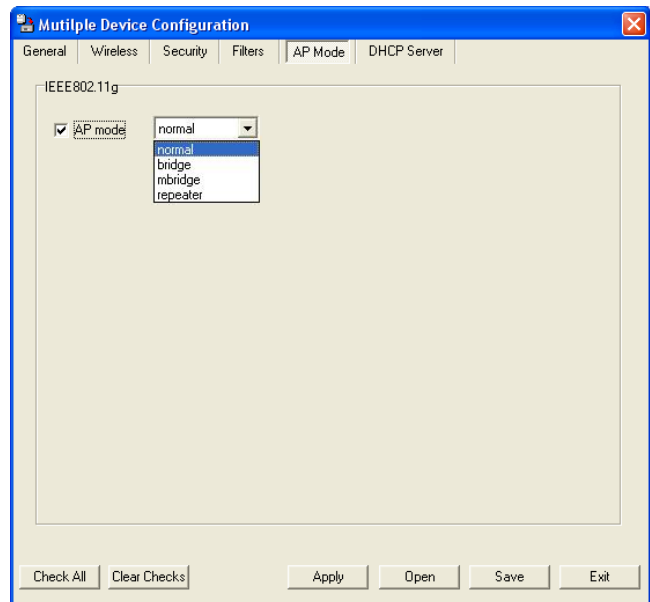



# Using the AP Manager (continued)

## Device Configuration>DHCP

- **DHCP Server:** Enable or disable the DHCP server function..
- **IP Assigned From:** Enter the first available IP address to be used on your network.
- **Range of Pool (1~255):** Enter the number of available IP addresses.
- **SubMask:** Enter the subnet mask.
- **Gateway:** Enter the gateway IP address, typically a router.
- **Wins:** Wins (Windows Internet Naming Service) is a system that determines the IP address of a network computer with a dynamically assigned IP address.
- **DNS:** The IP address of the DNS server.
- **Domain Name:** Enter the domain name of the DWL-2200AP.
- **Lease Time:** The period of time before the DHCP server will assign a new IP address.
- **Status:** This option turns on or off the dynamic pool settings.

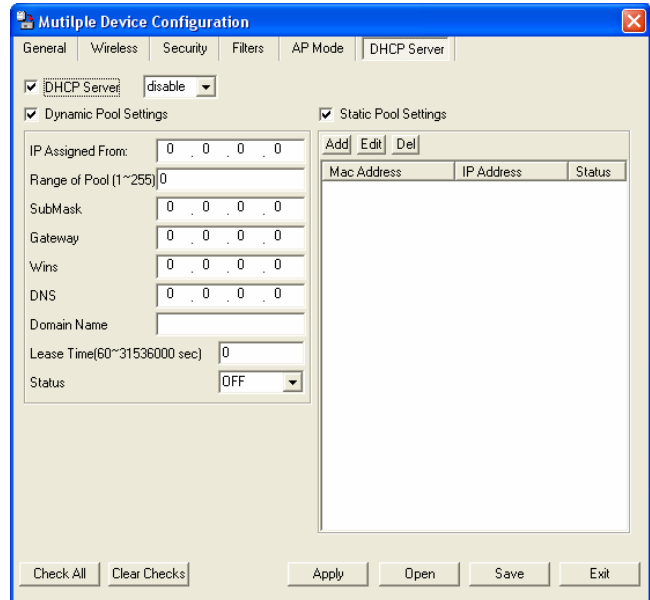

## Configuration Files

The DWL-2200AP allows you to save the device settings to a configuration file. To save a configuration file, follow these steps:

- Select a device from the Device List on the main screen of the AP Manager.
- Click the device configuration button.
- Click the **Save** button after you have all of the settings as you want them.
- A popup window will appear prompting you for a file name and location. Enter the file name, choose a file destination, and click **Save**.

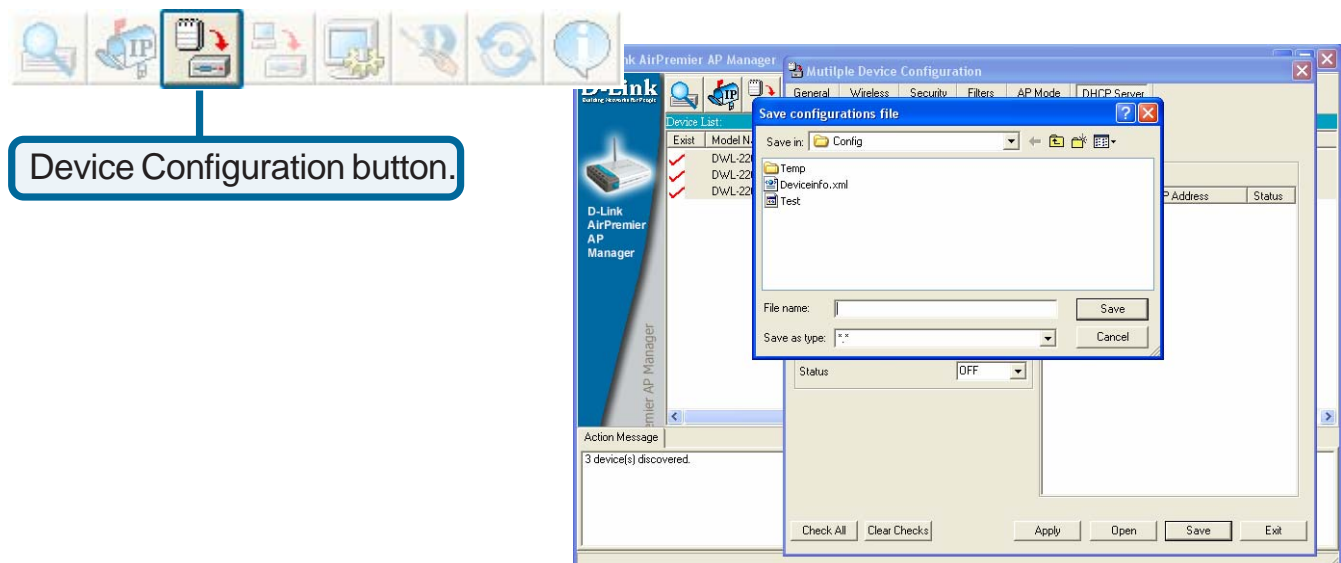

# Using the AP Manager (continued)

To load a previously saved configuration file, follow these steps:

- Select a device or devices from the Device List on the main screen of the AP Manager.
- Click the device configuration button.
- Click the **Open** button.
- A popup window will appear prompting you to locate the configuration file. Locate the file and click **Open**.
- The configuration file is loaded into the AP Manager but has not actually been written to the device(s). If you want to use the newly loaded configuration for the selected device(s), click **Apply** and the configuration settings will be written to the device(s).

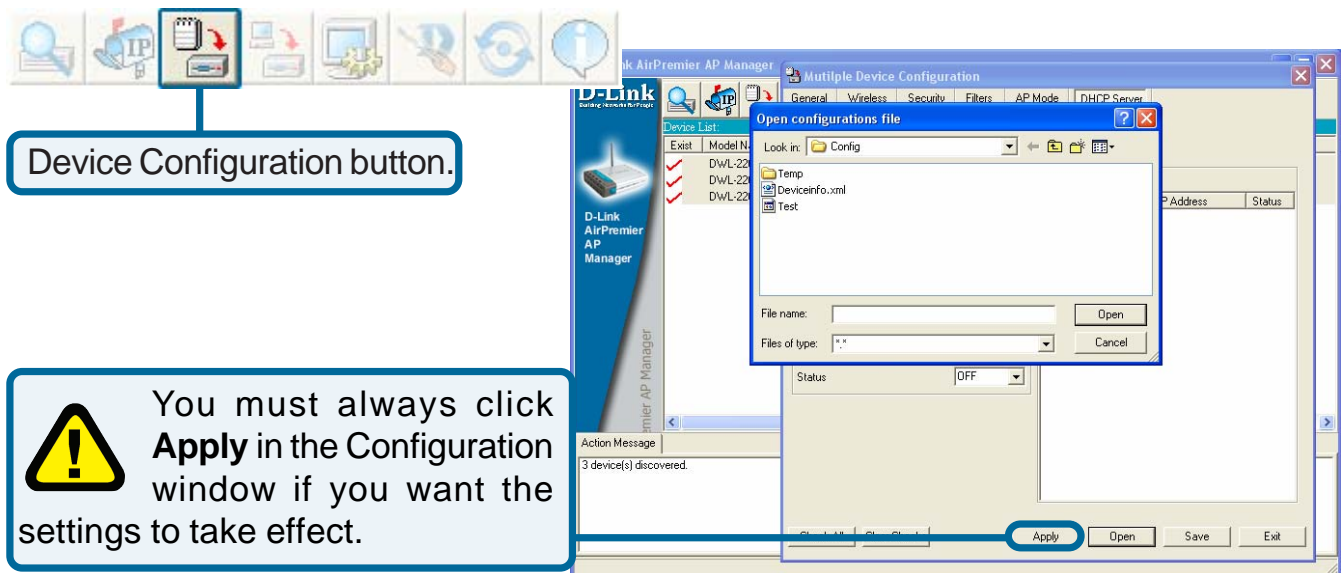

## Firmware



You can upgrade the firmware by clicking on this button after selecting the device(s).

To upgrade the firmware:

- Download the latest firmware upgrade from <http://support.dlink.com> to an easy to find location on your hard drive.
- Click on the firmware button as shown above.
- A popup window will appear. Locate the firmware upgrade file and click **Open**.  
**IMPORTANT! DO NOT DISCONNECT POWER FROM THE UNIT WHILE THE FIRMWARE IS BEING UPGRADED.**



# Using the AP Manager (continued)

## System Settings

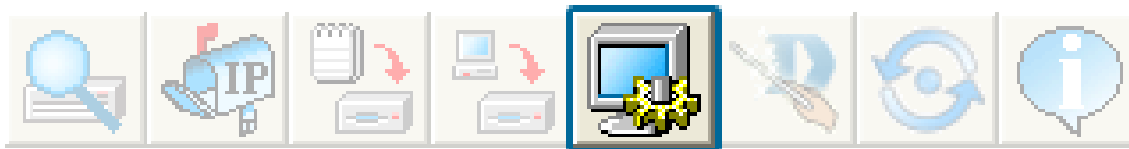

You can customize the basic System Settings for the DWL-2200AP by clicking on this button.

- **Access Password:** This sets the admin password for the selected device(s).
- **Auto Refresh:** This setting allows you to enable auto refreshing of the network device list. By default this option is disabled. If you choose to enable it, you must enter the refresh interval in seconds.

*All other settings on this screen should be left at the default setting.*

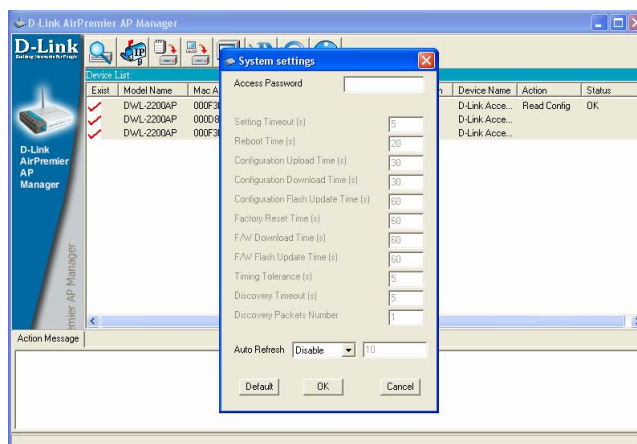

## Setup Wizard



This button will launch the Setup Wizard that will guide you through device configuration.

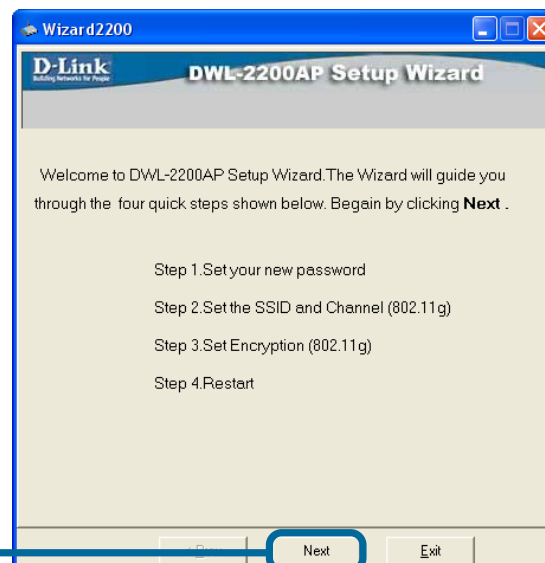

Click **Next**

# Using the AP Manager (continued)

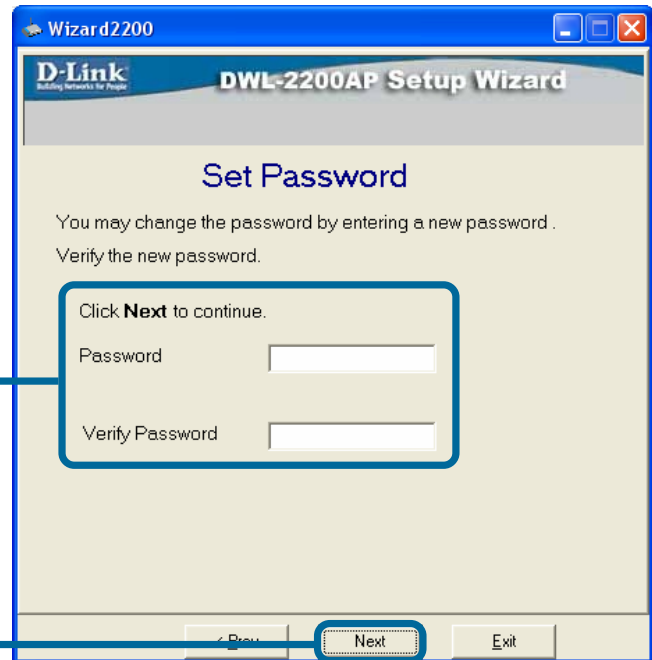
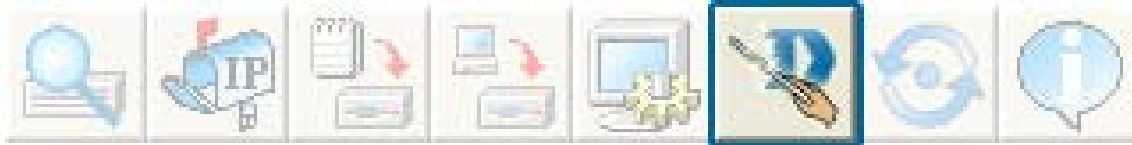

Enter a **Password** and retype it in the **Verify Password** field.

Click **Next**

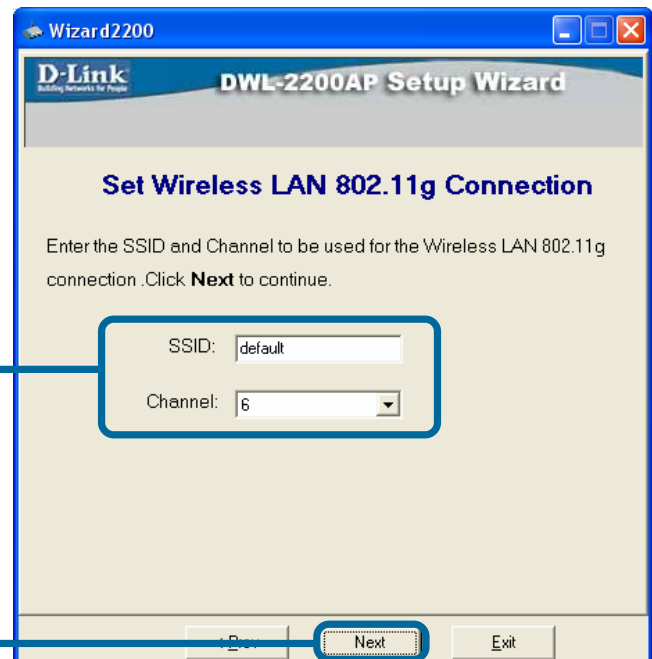

Enter the **SSID** and the **Channel** for the network.

Click **Next**

# Using the AP Manager (continued)

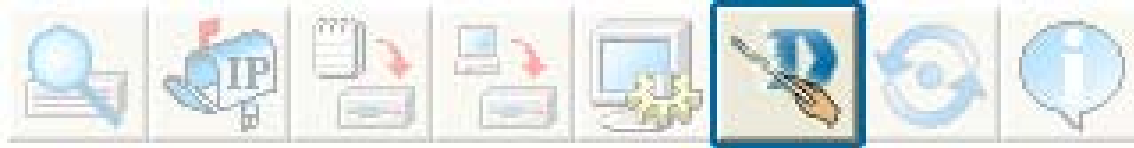

If you want to enable Encryption, enter the Encryption values here.

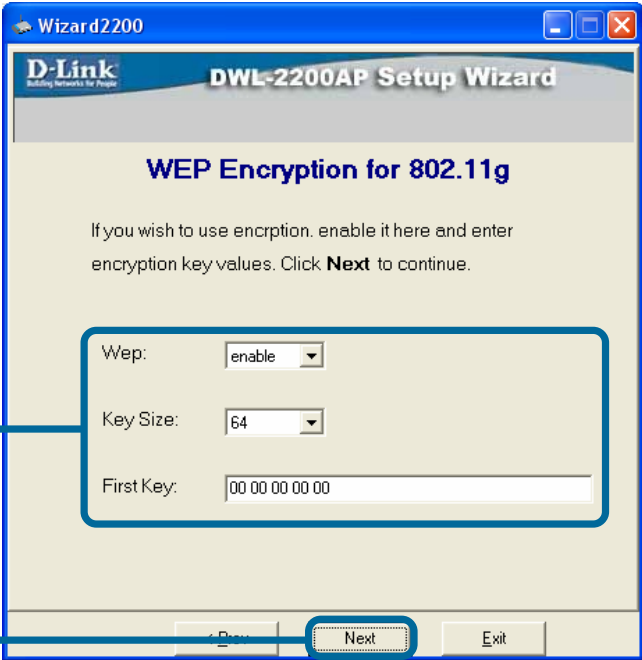

Click **Next**

The DWL-2200AP setup is complete!

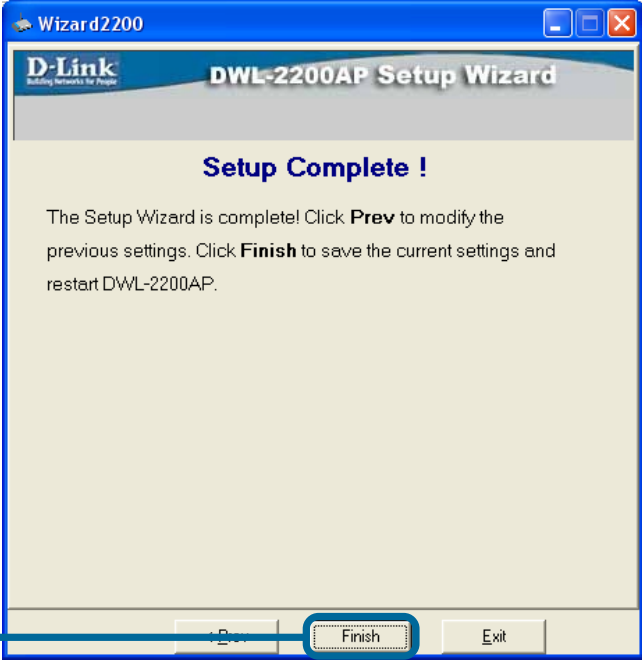

Click **Finish**

# Using the AP Manager (continued)

## Refresh

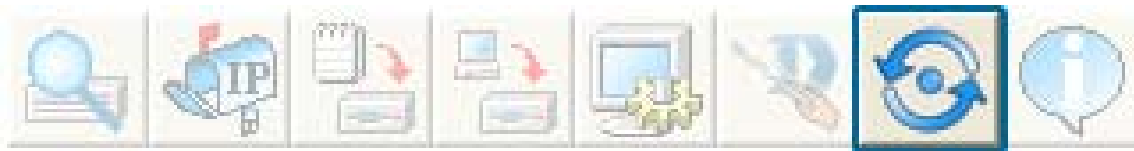

Click on this button to **refresh the list of devices** available on the network.

Devices with a checkmark next to them are still available on the network. Devices with an X are no longer available on the network.

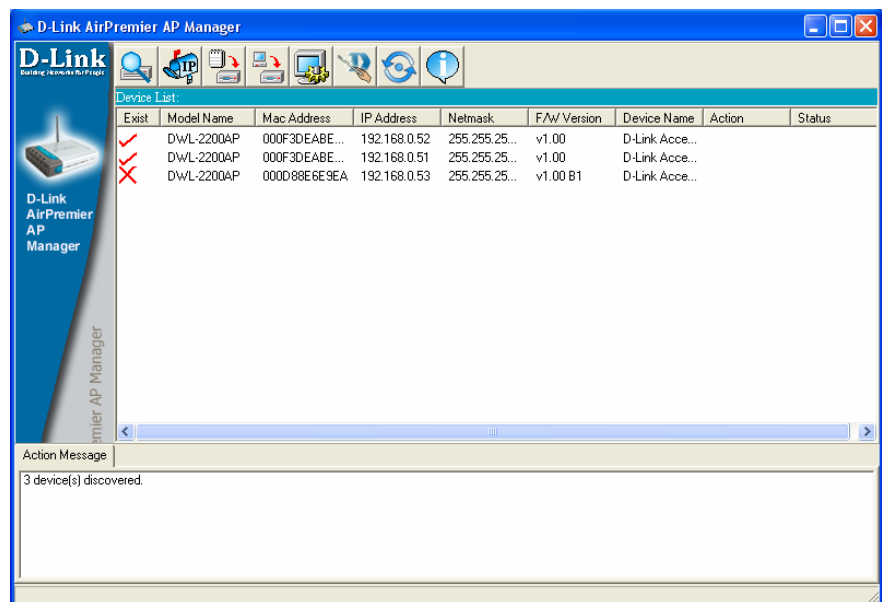

## About

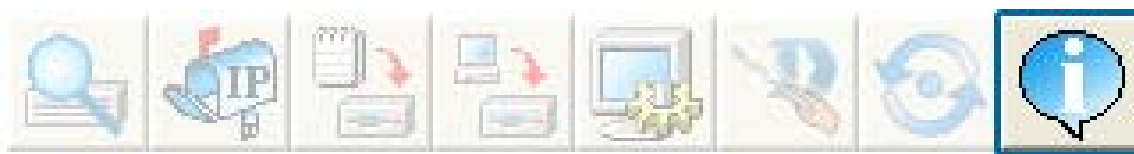

Click on this button to view the version of AP Manager.

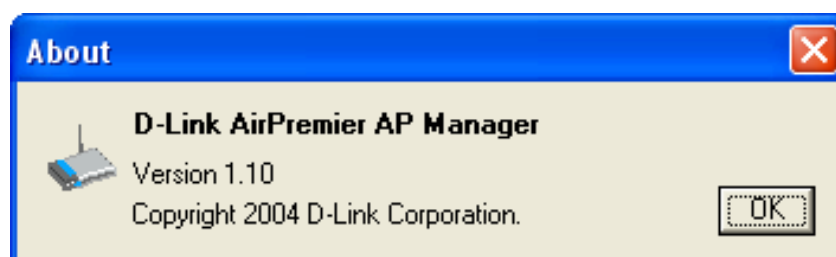

# Troubleshooting

This chapter provides solutions to problems that can occur during the installation and operation of the DWL-2200AP. We cover various aspects of the network setup, including the network adapters. Please read the following if you are having problems.

**Note:** *It is recommended that you use an Ethernet connection to configure the DWL-2200AP Wireless Access Point.*

## 1. The computer used to configure the DWL-2200AP cannot access the configuration menu.

- Check that the **Ethernet LED** on the DWL-2200AP is **ON**. If the **LED** is not **ON**, check that the cable for the Ethernet connection is securely inserted.
- Check that the Ethernet adapter is working properly. Please see item 3 (***Check that the drivers for the network adapters are installed properly***) in this **Troubleshooting** section to check that the drivers are loaded properly.
- Check that the **IP address** is in the same range and subnet as the DWL-2200AP. Please see ***Checking the IP Address in Windows XP*** in the **Networking Basics** section of this manual.

**Note:** *The IP address of the DWL-2200AP is 192.168.0.50. All the computers on the network must have a unique IP address in the same range, e.g., 192.168.0.x. Any computers that have identical IP addresses will not be visible on the network. They must all have the same subnet mask, e.g., 255.255.255.0*

- Do a **Ping test** to make sure that the DWL-2200AP is responding. Go to **Start>Run>Type Command>Type ping 192.168.0.50**. A successful ping will show four replies.

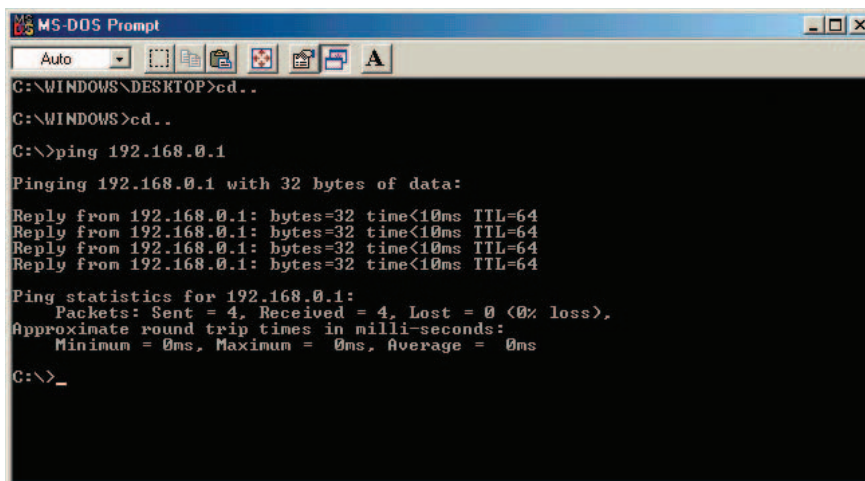

```
MS-DOS Prompt
Auto
C:\WINDOWS\DESKTOP>cd..
C:\WINDOWS>cd..
C:\>ping 192.168.0.1
Pinging 192.168.0.1 with 32 bytes of data:
Reply from 192.168.0.1: bytes=32 time<10ms TTL=64
Reply from 192.168.0.1: bytes=32 time<10ms TTL=64
Reply from 192.168.0.1: bytes=32 time<10ms TTL=64
Reply from 192.168.0.1: bytes=32 time<10ms TTL=64
Ping statistics for 192.168.0.1:
    Packets: Sent = 4, Received = 4, Lost = 0 (0% loss),
    Approximate round trip times in milli-seconds:
        Minimum = 0ms, Maximum = 0ms, Average = 0ms
C:\>_
```

*Note: If you have changed the default IP address, make sure to ping the correct IP address assigned to the DWL-2200AP.*



# Troubleshooting (continued)

## 2. The wireless client cannot access the Internet in Infrastructure mode.

Make sure the wireless client is associated and joined with the correct access point. To check this connection: **Right-click** on the **local area connection icon** in the taskbar > select **View Available Wireless Networks**. The **Connect to Wireless Network** screen will appear. Please make sure you have selected the correct available network, as shown in the illustration below.

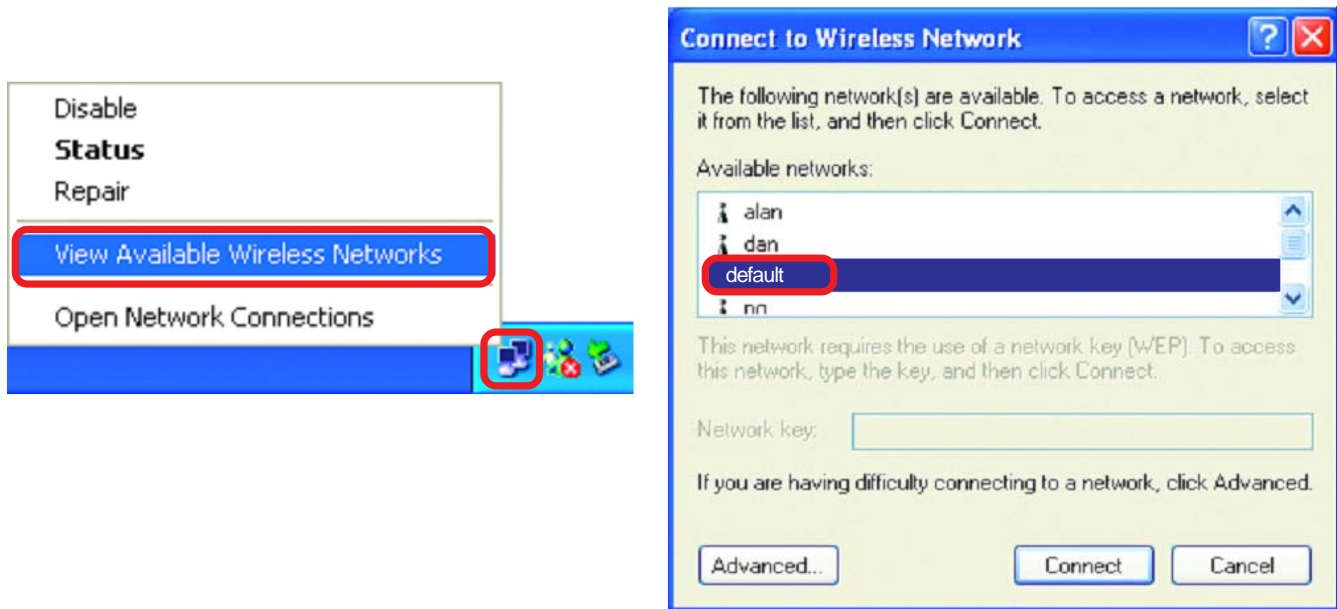

- Check that the **IP address** assigned to the wireless adapter is within the same **IP address range** as the access point and gateway. (Since the DWL-2200AP has an IP address of 192.168.0.50, wireless adapters must have an IP address in the same range, e.g., 192.168.0.x. Each device must have a unique IP address; no two devices may have the same IP address. The subnet mask must be the same for all the computers on the network.) To check the **IP address** assigned to the wireless adapter, **double-click** on the **local area connection icon** in the taskbar > select the **Support tab** and the **IP address** will be displayed. (Please refer to **Checking the IP address** in the **Networking Basics** section of this manual.)
- If it is necessary to assign a **static IP address** to the wireless adapter, please refer to the appropriate section in **Networking Basics**. If you are entering a **DNS server address** you must also enter the **default gateway address**. (Remember that if you have a DHCP-capable router, you will not need to assign a static IP address. See **Networking Basics: Assigning a Static IP Address**.)

# Troubleshooting (continued)

## 2. The wireless client cannot access the Internet in the Infrastructure mode (continued).

- Check to make sure that the router in your network is functioning properly by pinging it. If the router is not functioning properly, it will not connect to the Internet. If you need to find out how to ping network devices, please refer to **Checking the Wireless Connection by pinging** in the **Networking Basics** section of this manual.
- Check to make sure that the DNS server in your network is functioning properly by pinging it. If the DNS server is not functioning properly, you may be unable to access the Internet. Typically, your ISP (Internet Service Provider) will be able to give you the DNS server information.

## 3. Check that the drivers for the network adapters are installed properly.

*You may be using different network adapters than those illustrated here, but this procedure will remain the same, regardless of the type of network adapters you are using.*

- Go to **Start > My Computer > Properties**
- **Select the Hardware Tab**



- **Click Device Manager**

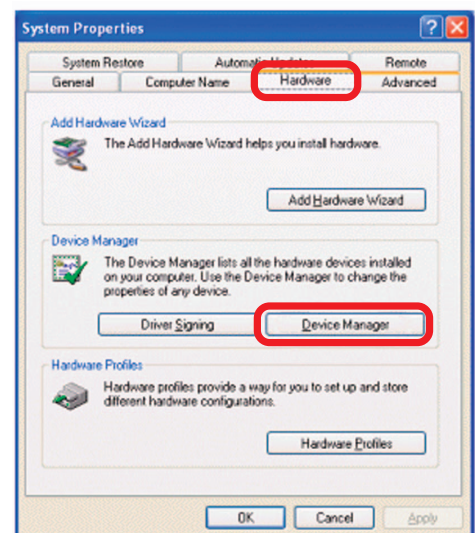

# Troubleshooting (continued)

- Click on the plus sign next to **Network Adapters**
- Right-click on **D-Link AirPlus DWL-G650 Wireless Cardbus Adapter** (In this example we use the DWL-G650; you may be using other network adapters, but the procedure will remain the same.)
- Select **Properties** to check that the drivers are installed properly

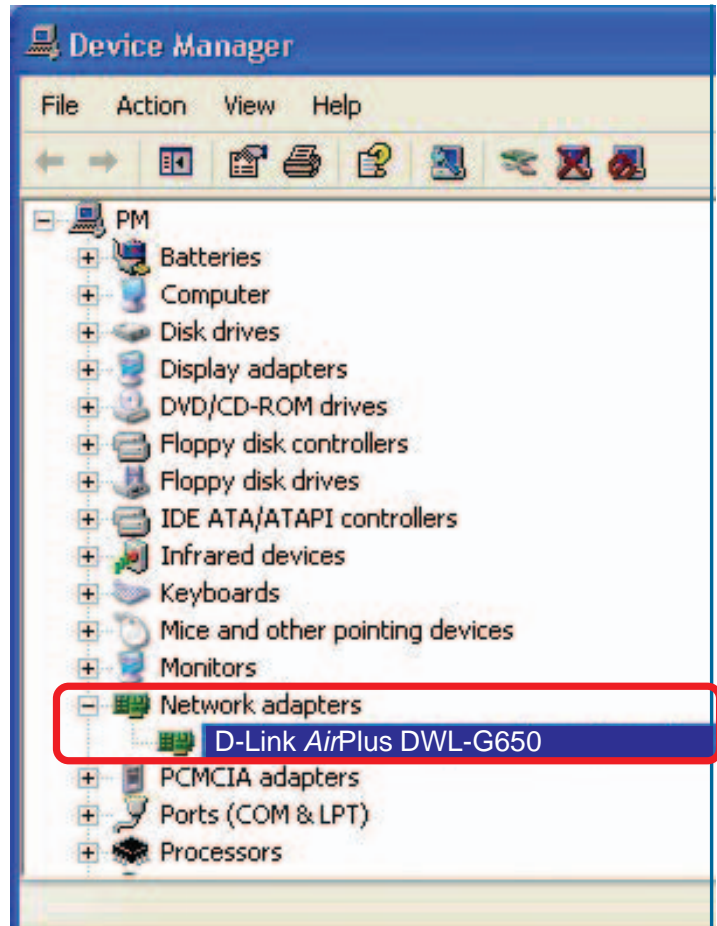

- Look under **Device Status** to check that the device is working properly

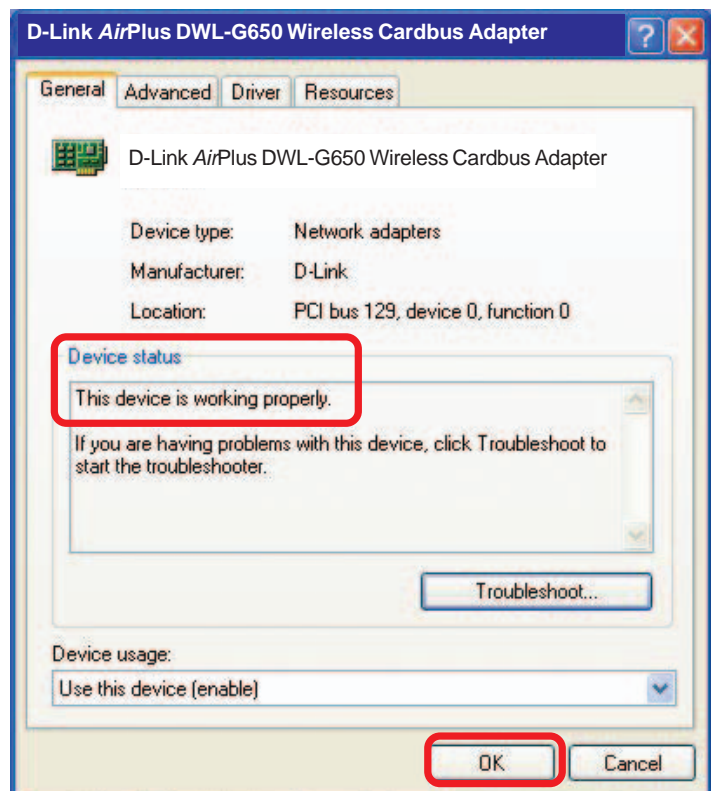

- Click **OK**

# Troubleshooting (continued)

## 4. What variables may cause my wireless products to lose reception?

D-Link products let you access your network from virtually anywhere you want. However, the positioning of the products within your environment will affect the wireless range. Please refer to **Installation Considerations** in the **Wireless Basics** section of this manual for further information about the most advantageous placement of your D-Link wireless products.

## 5. Why does my wireless connection keep dropping?

- Antenna Orientation- Try different antenna orientations for the DWL-2200AP. Try to keep the antenna at least 6 inches away from the wall or other objects.
- If you are using 2.4GHz cordless phones, X-10 equipment or other home security systems, ceiling fans, and lights, your wireless connection will degrade dramatically or drop altogether. Try changing the channel on your router, access point and wireless adapter to a different channel to avoid interference.
- Keep your product away (at least 3-6 feet) from electrical devices that generate RF noise, like microwaves, monitors, electric motors, etc.
- When deploying several access points and wireless devices, please make sure that access points in close proximity do not have overlapping channels. Nearby access points should be assigned channels that are at least 4 channels apart to prevent interference. For example, with a group of 3 access points you could assign the first to channel 1, the second to channel 6, and the third to channel 11.

## 6. Why can't I get a wireless connection?

If you have enabled encryption on the DWL-2200AP, you must also enable encryption on all wireless clients in order to establish a wireless connection.

- The encryption settings are: 64-, 128-, or 152-bit. Make sure that the encryption bit level is the same on the access point and the wireless client.
- Make sure that the SSID on the access point and the wireless client are exactly the same. If they are not, wireless connection will not be established.
- Move the DWL-2200AP and the wireless client into the same room and then test the wireless connection.
- Disable all security settings. (WEP, MAC Address Control)

# Troubleshooting (continued)

## 6. Why can't I get a wireless connection? (continued)

- Turn off your DWL-2200AP and the client. Turn the DWL-2200AP back on again, and then turn on the client.
- Make sure that all devices are set to **Infrastructure** mode.
- Check that the LED indicators are indicating normal activity. If not, check that the AC power and Ethernet cables are firmly connected.
- Check that the IP address, subnet mask, and gateway settings are correctly entered for the network.
- If you are using 2.4GHz cordless phones, X-10 equipment or other home security systems, ceiling fans, and lights, your wireless connection will degrade dramatically or drop altogether. Try changing the channel on your DWL-2200AP, and on all the devices in your network to avoid interference.
- Keep your product away (at least 3-6 feet) from electrical devices that generate RF noise, like microwaves, monitors, electric motors, etc.

## 7. I forgot my encryption key.

- Reset the DWL-2200AP to its factory default settings and restore the other devices on your network to their default settings. You may do this by pressing the Reset button on the back of the unit. You will lose the current configuration settings.



# Troubleshooting (continued)

## 8. Resetting the DWL-2200AP to Factory Default Settings

After you have tried other methods for troubleshooting your network, you may choose to **Reset** the DWL-2200AP to the factory default settings.



To hard-reset the D-Link DWL-2200AP to the Factory Default Settings, please do the following:

- Locate the **Reset** button on the back of the DWL-2200AP
- Use a paper clip to press the **Reset** button
- Hold for about 5 seconds and then release
- After the DWL-2100AP reboots (this may take a few minutes) it will be reset to the factory **Default** settings

# Technical Specifications

## Standards

- IEEE 802.11b
- IEEE 802.11g
- IEEE 802.3
- IEEE 802.3af
- IEEE 802.3u
- IEEE 802.3x

## Device Management

- Web-Based – Internet Explorer v6 or later; Netscape Navigator v6 or later; or other Java-enabled browsers.
- Telnet
- AP Manager
- SNMP v.3

## Data Rate\*

For 802.11g:

- 108, 54, 48, 36, 24, 18, 12, 9 and 6Mbps

For 802.11b:

- 11, 5.5, 2, and 1Mbps

## Security

- 64-, 128-, 152-bit WEP
- WPA – Wi-Fi Protected Access (WPA-TKIP/PSK/AES)
- 802.1x (EAP-MD5/TLS/TTLS/PEAP)
- MAC Address Access Control List

## Wireless Frequency Range

- 2.4GHz to 2.4835GHz

## Wireless Operating Range\*

802.11g (Full Power with 5dBi gain diversity dipole antenna)

### Indoors:

- 98ft (30m) @ 54Mbps
- 108ft (33m) @ 48Mbps
- 121ft (37m) @ 36Mbps
- 151ft (46m) @ 24Mbps
- 203ft (62m) @ 18Mbps
- 223ft (68m) @ 12Mbps
- 256ft (78m) @ 9Mbps
- 302ft (92m) @ 6Mbps

### Outdoors:

- 328ft (100m) @ 54Mbps
- 968ft (295m) @ 11Mbps
- 1378ft (420m) @ 6Mbps

# Technical Specifications (continued)

## Antenna Type

- Dipole antenna with 5dBi gain

## Operating Voltage

- 48VDC +/- 10% for PoE

## Radio and Modulation Type

For 802.11b:

### DSSS:

- DBPSK @ 1Mbps
- DQPSK @ 2Mbps
- CCK @ 5.5 and 11Mbps

For 802.11g:

### OFDM:

- BPSK @ 6 and 9Mbps
- QPSK @ 12 and 18Mbps
- 16QAM @ 24 and 36Mbps
- 64QAM @ 48 and 54Mbps

### DSSS:

- DBPSK @ 1Mbps
- DQPSK @ 2Mbps
- CCK @ 5.5 and 11Mbps

## Transmit Output Power

For 802.11b:

- 63mW (18dBm)
- 40mW (16dBm)
- 32mW (15dBm)
- 23mW (13dBm)
- 10mW (10dBm)
- 6mW (7dBm)
- 1mW (0dBm)

For 802.11g:

- 63mW (18dBm)
- 40mW (16dBm)
- 32mW (15dBm)
- 6mW (7dBm)
- 1mW (0dBm)

## Receiver Sensitivity

For 802.11b:

- 1Mbps: -94dBm
- 2Mbps: -90dBm
- 5.5Mbps: -88dBm
- 11Mbps: -85dBm

For 802.11g:

- 1Mbps: -94dBm
- 2Mbps: -91dBm
- 5.5Mbps: -89dBm
- 6Mbps: -91dBm
- 9Mbps: -90dBm
- 11Mbps: -86dBm
- 12Mbps: -89dBm
- 18Mbps: -87dBm
- 24Mbps: -84dBm
- 36Mbps: -80dBm
- 48Mbps: -76dBm
- 54Mbps: -73dBm

# Technical Specifications (continued)

## LEDs

- Power
- 10M/100M
- WLAN

## Temperature

- Operating: 32°F to 104°F (0°C to 40°C)
- Storing: -4°F to 149°F (-20°C to 65°C)

## Humidity

- Operating: 10%~90% (non-condensing)
- Storing: 5%~95% (non-condensing)

## Certifications

- FCC Part 15
- UL

## Dimensions

- L = 5.59 inches (142mm)
- W = 4.29 inches (109mm)
- H = 1.22 inches (31mm)

## Weight

- 0.44 lbs (200g)

## Warranty

- 1 Year

\*Maximum wireless signal rate derived from IEEE Standard 802.11g specifications. Actual data throughput will vary. Network conditions and environmental factors lower actual data throughput rate.

# Technical Support

You can find software updates and user documentation on the D-Link website.

D-Link provides free technical support for customers within the United States and within Canada for the duration of the warranty period on this product.

U.S. and Canadian customers can contact D-Link technical support through our web site, or by phone.

## Tech Support for customers within the United States:

### ***D-Link Technical Support over the Telephone:***

(877) 453-5465

24 hours a day, seven days a week.

### ***D-Link Technical Support over the Internet:***

<http://support.dlink.com>

email:[support@dlink.com](mailto:support@dlink.com)

## Tech Support for customers within Canada:

### ***D-Link Technical Support over the Telephone:***

(800) 361-5265

Monday to Friday 7:30am to 12:00pm EST

### ***D-Link Technical Support over the Internet:***

<http://support.dlink.ca>

email:[support@dlink.ca](mailto:support@dlink.ca)



Subject to the terms and conditions set forth herein, D-Link Systems, Inc. ("D-Link") provides this Limited warranty for its product only to the person or entity that originally purchased the product from:

- D-Link or its authorized reseller or distributor and
- Products purchased and delivered within the fifty states of the United States, the District of Columbia, U.S. Possessions or Protectorates, U.S. Military Installations, addresses with an APO or FPO.

**Limited Warranty:** D-Link warrants that the hardware portion of the D-Link products described below will be free from material defects in workmanship and materials from the date of original retail purchase of the product, for the period set forth below applicable to the product type ("Warranty Period"), except as otherwise stated herein.

1-Year Limited Warranty for the Product(s) is defined as follows:

- Hardware (excluding power supplies and fans) One (1) Year
- Power Supplies and Fans One (1) Year
- Spare parts and spare kits Ninety (90) days

D-Link's sole obligation shall be to repair or replace the defective Hardware during the Warranty Period at no charge to the original owner or to refund at D-Link's sole discretion. Such repair or replacement will be rendered by D-Link at an Authorized D-Link Service Office. The replacement Hardware need not be new or have an identical make, model or part. D-Link may in its sole discretion replace the defective Hardware (or any part thereof) with any reconditioned product that D-Link reasonably determines is substantially equivalent (or superior) in all material respects to the defective Hardware. Repaired or replacement Hardware will be warranted for the remainder of the original Warranty Period from the date of original retail purchase. If a material defect is incapable of correction, or if D-Link determines in its sole discretion that it is not practical to repair or replace the defective Hardware, the price paid by the original purchaser for the defective Hardware will be refunded by D-Link upon return to D-Link of the defective Hardware. All Hardware (or part thereof) that is replaced by D-Link, or for which the purchase price is refunded, shall become the property of D-Link upon replacement or refund.

**Limited Software Warranty:** D-Link warrants that the software portion of the product ("Software") will substantially conform to D-Link's then current functional specifications for the Software, as set forth in the applicable documentation, from the date of original retail purchase of the Software for a period of ninety (90) days ("Warranty Period"), provided that the Software is properly installed on approved hardware and operated as contemplated in its documentation. D-Link further warrants that, during the Warranty Period, the magnetic media on which D-Link delivers the Software will be free of physical defects. D-Link's sole obligation shall be to replace the non-conforming Software (or defective media) with software that substantially conforms to D-Link's functional specifications for the Software or to refund at D-Link's sole discretion. Except as otherwise agreed by D-Link in writing, the replacement Software is provided only to the original licensee, and is subject to the terms and conditions of the license granted by D-Link for the Software. Software will be warranted for the remainder of the original Warranty Period from the date of original retail purchase. If a material non-conformance is incapable of correction, or if D-Link determines in its sole discretion that it is not practical to replace the non-conforming Software, the price paid by the original licensee for the non-conforming Software will be refunded by D-Link; provided that the non-conforming Software (and all copies thereof) is first returned to D-Link. The license granted respecting any Software for which a refund is given automatically terminates.

**Non-Applicability of Warranty:** The Limited Warranty provided hereunder for hardware and software of D-Link's products will not be applied to and does not cover any refurbished product and any product purchased through the inventory clearance or liquidation sale or other sales in which D-Link, the sellers, or the liquidators expressly disclaim their warranty obligation pertaining to the product and in that case, the product is being sold "As-Is" without any warranty whatsoever including, without limitation, the Limited Warranty as described herein, notwithstanding anything stated herein to the contrary.

**Submitting A Claim:** The customer shall return the product to the original purchase point based on its return policy. In case the return policy period has expired and the product is within warranty, the customer shall submit a claim to D-Link as outlined below:

- The customer must submit with the product as part of the claim a written description of the Hardware defect or Software nonconformance in sufficient detail to allow D-Link to confirm the same.

- The original product owner must obtain a Return Material Authorization (“RMA”) number from the Authorized D-Link Service Office and, if requested, provide written proof of purchase of the product (such as a copy of the dated purchase invoice for the product) before the warranty service is provided.
- After an RMA number is issued, the defective product must be packaged securely in the original or other suitable shipping package to ensure that it will not be damaged in transit, and the RMA number must be prominently marked on the outside of the package. Do not include any manuals or accessories in the shipping package. D-Link will only replace the defective portion of the Product and will not ship back any accessories.
- The customer is responsible for all in-bound shipping charges to D-Link. No Cash on Delivery (“COD”) is allowed. Products sent COD will either be rejected by D-Link or become the property of D-Link. Products shall be fully insured by the customer. D-Link will not be held responsible for any packages that are lost in transit to D-Link. The repaired or replaced packages will be shipped to the customer via UPS Ground or any common carrier selected by D-Link, with shipping charges prepaid. Expedited shipping is available if shipping charges are prepaid by the customer and upon request.
- Return Merchandise Ship-To Address  
**USA:** 17595 Mt. Herrmann, Fountain Valley, CA 92708  
**Canada:** 2180 Winston Park Drive, Oakville, ON, L6H 5W1 (Visit <http://www.dlink.ca> for detailed warranty information within Canada)

D-Link may reject or return any product that is not packaged and shipped in strict compliance with the foregoing requirements, or for which an RMA number is not visible from the outside of the package. The product owner agrees to pay D-Link’s reasonable handling and return shipping charges for any product that is not packaged and shipped in accordance with the foregoing requirements, or that is determined by D-Link not to be defective or non-conforming.

**What Is Not Covered:** This limited warranty provided by D-Link does not cover: Products, if in D-Link’s judgment, have been subjected to abuse, accident, alteration, modification, tampering, negligence, misuse, faulty installation, lack of reasonable care, repair or service in any way that is not contemplated in the documentation for the product, or if the model or serial number has been altered, tampered with, defaced or removed; Initial installation, installation and removal of the product for repair, and shipping costs; Operational adjustments covered in the operating manual for the product, and normal maintenance; Damage that occurs in shipment, due to act of God, failures due to power surge, and cosmetic damage; Any hardware, software, firmware or other products or services provided by anyone other than D-Link; Products that have been purchased from inventory clearance or liquidation sales or other sales in which D-Link, the sellers, or the liquidators expressly disclaim their warranty obligation pertaining to the product. Repair by anyone other than D-Link or an Authorized D-Link Service Office will void this Warranty.

**Disclaimer of Other Warranties:** EXCEPT FOR THE LIMITED WARRANTY SPECIFIED HEREIN, THE PRODUCT IS PROVIDED “AS-IS” WITHOUT ANY WARRANTY OF ANY KIND WHATSOEVER INCLUDING, WITHOUT LIMITATION, ANY WARRANTY OF MERCHANTABILITY, FITNESS FOR A PARTICULAR PURPOSE AND NON-INFRINGEMENT. IF ANY IMPLIED WARRANTY CANNOT BE DISCLAIMED IN ANY TERRITORY WHERE A PRODUCT IS SOLD, THE DURATION OF SUCH IMPLIED WARRANTY SHALL BE LIMITED TO NINETY (90) DAYS. EXCEPT AS EXPRESSLY COVERED UNDER THE LIMITED WARRANTY PROVIDED HEREIN, THE ENTIRE RISK AS TO THE QUALITY, SELECTION AND PERFORMANCE OF THE PRODUCT IS WITH THE PURCHASER OF THE PRODUCT.

**Limitation of Liability:** TO THE MAXIMUM EXTENT PERMITTED BY LAW, D-LINK IS NOT LIABLE UNDER ANY CONTRACT, NEGLIGENCE, STRICT LIABILITY OR OTHER LEGAL OR EQUITABLE THEORY FOR ANY LOSS OF USE OF THE PRODUCT, INCONVENIENCE OR DAMAGES OF ANY CHARACTER, WHETHER DIRECT, SPECIAL, INCIDENTAL OR CONSEQUENTIAL (INCLUDING, BUT NOT LIMITED TO, DAMAGES FOR LOSS OF GOODWILL, LOSS OF REVENUE OR PROFIT, WORK STOPPAGE, COMPUTER FAILURE OR MALFUNCTION, FAILURE OF OTHER EQUIPMENT OR COMPUTER PROGRAMS TO WHICH D-LINK’S PRODUCT IS CONNECTED WITH, LOSS OF INFORMATION OR DATA CONTAINED IN, STORED ON, OR INTEGRATED WITH ANY PRODUCT RETURNED TO D-LINK FOR WARRANTY SERVICE) RESULTING FROM THE USE OF THE PRODUCT, RELATING TO WARRANTY SERVICE, OR ARISING OUT OF ANY BREACH OF THIS LIMITED WARRANTY, EVEN IF D-LINK HAS BEEN ADVISED OF THE POSSIBILITY OF SUCH DAMAGES. THE SOLE REMEDY FOR A BREACH OF THE FOREGOING LIMITED WARRANTY IS REPAIR, REPLACEMENT OR REFUND OF THE DEFECTIVE OR NON-CONFORMING PRODUCT. THE MAXIMUM LIABILITY OF D-LINK UNDER THIS WARRANTY IS LIMITED TO THE PURCHASE PRICE OF THE PRODUCT COVERED BY THE WARRANTY. THE FOREGOING EXPRESS WRITTEN WARRANTIES AND REMEDIES ARE EXCLUSIVE AND ARE IN LIEU OF ANY OTHER WARRANTIES OR REMEDIES, EXPRESS, IMPLIED OR STATUTORY.

**Governing Law:** This Limited Warranty shall be governed by the laws of the State of California. Some states do not allow exclusion or limitation of incidental or consequential damages, or limitations on how long an implied warranty lasts, so the foregoing limitations and exclusions may not apply. This limited warranty provides specific legal rights and the product owner may also have other rights which vary from state to state.

**Trademarks:** D-Link is a registered trademark of D-Link Systems, Inc. Other trademarks or registered trademarks are the property of their respective manufacturers or owners.

**Copyright Statement:** No part of this publication or documentation accompanying this Product may be reproduced in any form or by any means or used to make any derivative such as translation, transformation, or adaptation without permission from D-Link Corporation/D-Link Systems, Inc., as stipulated by the United States Copyright Act of 1976. Contents are subject to change without prior notice. Copyright© 2002 by D-Link Corporation/D-Link Systems, Inc. All rights reserved.

**CE Mark Warning:** This is a Class B product. In a domestic environment, this product may cause radio interference, in which case the user may be required to take adequate measures.

**FCC Statement:** This equipment has been tested and found to comply with the limits for a Class B digital device, pursuant to part 15 of the FCC Rules. These limits are designed to provide reasonable protection against harmful interference in a residential installation. This equipment generates, uses, and can radiate radio frequency energy and, if not installed and used in accordance with the instructions, may cause harmful interference to radio communication. However, there is no guarantee that interference will not occur in a particular installation. If this equipment does cause harmful interference to radio or television reception, which can be determined by turning the equipment off and on, the user is encouraged to try to correct the interference by one or more of the following measures:

- Reorient or relocate the receiving antenna.
- Increase the separation between the equipment and receiver.
- Connect the equipment into an outlet on a circuit different from that to which the receiver is connected.
- Consult the dealer or an experienced radio/TV technician for help.

**FCC Caution:**

The manufacturer is not responsible for any radio or TV interference caused by unauthorized modifications to this equipment; such modifications could void the user's authority to operate the equipment.

D-Link declares that DWL-2200AP is limited in CH1~CH11 by specified firmware controlled in the USA.

This device complies with Part 15 of the FCC Rules. Operation is subject to the following two conditions: (1) This device may not cause harmful interference, and (2) this device must accept any interference received, including interference that may cause undesired operation.

**Important Note:**

**FCC Radiation Exposure Statement:**

This equipment complies with FCC radiation exposure limits set forth for an uncontrolled environment. The antenna(s) used for this equipment must be installed to provide a separation distance of at least eight inches (20cm) from all persons.

**For detailed warranty outside the United States, please contact corresponding local D-Link office.**

Register your D-Link product online at <http://support.dlink.com/register/>

(10/15/04)