

# TP-LINK®

## User Guide

**TD-W8901N**

**150Mbps Wireless N ADSL2+ Modem Router**



## **COPYRIGHT & TRADEMARKS**

Specifications are subject to change without notice. **TP-LINK**<sup>®</sup> is a registered trademark of TP-LINK TECHNOLOGIES CO., LTD. Other brands and product names are trademarks or registered trademarks of their respective holders.

No part of the specifications may be reproduced in any form or by any means or used to make any derivative such as translation, transformation, or adaptation without permission from TP-LINK TECHNOLOGIES CO., LTD. Copyright © 2016 TP-LINK TECHNOLOGIES CO., LTD. All rights reserved.

<http://www.tp-link.com>

## **FCC STATEMENT**



This equipment has been tested and found to comply with the limits for a Class B digital device, pursuant to part 15 of the FCC Rules. These limits are designed to provide reasonable protection against harmful interference in a residential installation. This equipment generates, uses and can radiate radio frequency energy and, if not installed and used in accordance with the instructions, may cause harmful interference to radio communications. However, there is no guarantee that interference will not occur in a particular installation. If this equipment does cause harmful interference to radio or television reception, which can be determined by turning the equipment off and on, the user is encouraged to try to correct the interference by one or more of the following measures:

- Reorient or relocate the receiving antenna.
- Increase the separation between the equipment and receiver.
- Connect the equipment into an outlet on a circuit different from that to which the receiver is connected.
- Consult the dealer or an experienced radio/ TV technician for help.

This device complies with part 15 of the FCC Rules. Operation is subject to the following two conditions:

- 1) This device may not cause harmful interference.
- 2) This device must accept any interference received, including interference that may cause undesired operation.

Any changes or modifications not expressly approved by the party responsible for compliance could void the user's authority to operate the equipment.

Note: The manufacturer is not responsible for any radio or TV interference caused by unauthorized modifications to this equipment. Such modifications could void the user's authority to operate the equipment.

## **FCC RF Radiation Exposure Statement**

This equipment complies with FCC RF radiation exposure limits set forth for an uncontrolled environment. This device and its antenna must not be co-located or operating in conjunction with any other antenna or transmitter.

"To comply with FCC RF exposure compliance requirements, this grant is applicable to only Mobile Configurations. The antennas used for this transmitter must be installed to provide a separation distance of at least 20 cm from all persons and must not be co-located or operating in conjunction with any other antenna or transmitter.

## CE Mark Warning

# CE 1588

This is a class B product. In a domestic environment, this product may cause radio interference, in which case the user may be required to take adequate measures.

## RF Exposure Information

This device meets the EU requirements (1999/5/EC Article 3.1a) on the limitation of exposure of the general public to electromagnetic fields by way of health protection.

The device complies with RF specifications when the device used at 20 cm from your body.

## UkrSEPRO



Продукт сертифіковано згідно с правилами системи УкрСЕПРО на відповідність вимогам нормативних документів та вимогам, що передбачені чинними законодавчими актами України.

## Safety Information

- When product has power button, the power button is one of the way to shut off the product; when there is no power button, the only way to completely shut off power is to disconnect the product or the power adapter from the power source.
- Don't disassemble the product, or make repairs yourself. You run the risk of electric shock and voiding the limited warranty. If you need service, please contact us.
- Avoid water and wet locations.
- Adapter shall be installed near the equipment and shall be easily accessible.
- The plug considered as disconnect device of adapter.



- Use only power supplies which are provided by manufacturer and in the original packing of this product. If you have any questions, please don't hesitate to contact us.

## Explanation of the symbols on the product label

| Symbol | Explanation        |
|--------|--------------------|
|        | Class II equipment |
|        | DC voltage         |



## RECYCLING

This product bears the selective sorting symbol for Waste electrical and electronic equipment (WEEE). This means that this product must be handled pursuant to European directive 2012/19/EU in order to be recycled or dismantled to minimize its impact on the environment.

User has the choice to give his product to a competent recycling organization or to the retailer when he buys a new electrical or electronic equipment.

---

# CONTENTS

|  |           |
|--|-----------|
| <b>Chapter 1. Introduction</b>             | <b>1</b>  |
| 1.1 Product Overview                       | 1         |
| 1.2 Main Features                          | 1         |
| 1.3 Conventions                            | 2         |
| <b>Chapter 2. Hardware Installation</b>    | <b>3</b>  |
| 2.1 The Front Panel                        | 3         |
| 2.2 The Back Panel                         | 5         |
| 2.3 Installation Environment               | 6         |
| 2.4 Connecting the Modem Router            | 6         |
| <b>Chapter 3. Quick Installation Guide</b> | <b>8</b>  |
| 3.1 TCP/IP Configuration                   | 8         |
| 3.2 Login                                  | 9         |
| <b>Chapter 4. Software Configuration</b>   | <b>12</b> |
| 4.1 Status                                 | 12        |
| 4.1.1 Device Info                          | 12        |
| 4.1.2 System Log                           | 13        |
| 4.1.3 Statistics                           | 14        |
| 4.2 Quick Start                            | 17        |
| 4.3 Interface Setup                        | 17        |
| 4.3.1 Internet                             | 17        |
| 4.3.2 LAN                                  | 27        |
| 4.3.3 Wireless                             | 31        |
| 4.3.4 6RD                                  | 42        |
| 4.3.5 Guest Network                        | 43        |
| 4.4 Advanced Setup                         | 44        |
| 4.4.1 Firewall                             | 45        |
| 4.4.2 Routing                              | 45        |
| 4.4.3 NAT                                  | 46        |
| 4.4.4 QoS                                  | 50        |
| 4.4.5 VLAN                                 | 53        |
| 4.4.6 ADSL                                 | 55        |
| 4.5 Access Management                      | 56        |

|  |                      |           |
|--|----------------------|-----------|
| 4.5.1                                      | ACL .....            | 56        |
| 4.5.2                                      | Filter .....         | 58        |
| 4.5.3                                      | SNMP .....           | 67        |
| 4.5.4                                      | UPnP .....           | 67        |
| 4.5.5                                      | DDNS .....           | 68        |
| 4.5.6                                      | CWMP .....           | 69        |
| 4.6  | Maintenance .....    | 70        |
| 4.6.1                                      | Administration ..... | 70        |
| 4.6.2                                      | Time Zone .....      | 70        |
| 4.6.3                                      | Firmware .....       | 72        |
| 4.6.4                                      | SysRestart .....     | 74        |
| 4.6.5                                      | Diagnostics .....    | 74        |
| 4.7  | Help .....           | 75        |
| <b>Appendix A: Specifications .....</b>    |                      | <b>77</b> |
| <b>Appendix B: Troubleshooting .....</b>   |                      | <b>78</b> |
| <b>Appendix C: Technical Support .....</b> |                      | <b>81</b> |

# Chapter 1. Introduction

Thank you for choosing the **TD-W8901N 150Mbps Wireless N ADSL2+ Modem Router**.

## 1.1 Product Overview

The device is designed to provide a simple and cost-effective ADSL Internet connection for a private Ethernet or IEEE 802.11n/ IEEE 802.11g/ IEEE 802.11b wireless network.

The TD-W8901N connects to an Ethernet LAN or computers via standard Ethernet ports. The ADSL connection is made using ordinary telephone line with standard connectors. Multiple workstations can be networked and connected to the Internet using a single Wide Area Network (WAN) interface and single global IP address. The advanced security enhancements, IP/MAC Filter, Application Filter and URL Filter can help to protect your network from potentially devastating intrusions by malicious agents from the outside of your network.

Quick Start of the Web-based Utility is supplied and friendly help messages are provided for the configuration. Network and Router management is done through the Web-based Utility which can be accessed through local Ethernet using any web browser.

The TD-W8901N supports full-rate ADSL2+ connectivity conforming to the ITU and ANSI specifications. In addition to the basic DMT physical layer functions, the ADSL2+ PHY supports dual latency ADSL2+ framing (fast and interleaved) and the I.432 ATM Physical Layer.

In the most attentive wireless security, the modem router provides multiple protection measures. It can be set to turn off the wireless network name (SSID) broadcast so that only stations that have the SSID can be connected. The modem router provides wireless LAN 64/128-bit WEP encryption security, WPA-PSK/WPA2-PSK authentication, as well as TKIP/AES encryption security.

## 1.2 Main Features

- Four 10/100Mbps Auto-Negotiation RJ45 LAN ports (Auto MDI/MDIX), one RJ11 port.
- Provides external splitter.
- Adopts Advanced DMT modulation and demodulation technology.
- Supports bridge mode and Router function.
- Multi-user sharing a high-speed Internet connection.
- Downstream data rates up to 24Mbps, upstream data rates up to 2.5Mbps ( With Annex M enabled ) .
- Supports long transfers, the max line length can reach to 6.5Km.



- Supports remote configuration and management through SNMP and CWMP.
- Supports PPPoE, and it allows connecting the Internet on demand and disconnecting from the Internet when idle.
- Provides reliable ESD and surge-protect function with quick response semi-conductive surge protection circuit.
- High speed and asymmetrical data transmit mode, provides safe and exclusive bandwidth.
- Supports All ADSL industrial standards.
- Compatible with all mainstream DSLAM (CO).
- Provides integrated access to Internet and route function which face to SOHO user.
- Real-time Configuration and device monitoring.
- Supports Multiple PVC (Permanent Virtual Circuit).
- Built-in DHCP server.
- Built-in firewall, supporting IP/MAC filter, Application filter and URL filter.
- Supports Virtual Server, DMZ host and IP Address Mapping.
- Supports Dynamic DNS, UPnP and Static Routing.
- Supports system log and flow Statistics.
- Supports firmware upgrade and Web management.
- Provides WPA-PSK/WPA2-PSK data security, TKIP/AES encryption security.
- Provides 64/128-bit WEP encryption security and wireless LAN ACL (Access Control List).
- Supports IPv6.

### **1.3 Conventions**

The modem router or device mentioned in this User Guide stands for TD-W8901N without any explanations.

Parameters provided in the pictures are just references for setting up the product, which may differ from the actual situation.

## Chapter 2. Hardware Installation

### 2.1 The Front Panel



Figure 2-1

The LEDs locate on the front panel. They indicate the device's working status. For details, please refer to LEDs Explanation.

#### LEDs Explanation:

| Name         | Status | Indication  |
|--------------|--------|---|
| ⏻ (Power)    | On     | The modem router is powered on.   |
|              | Off    | The modem router is off. Please ensure that the power adapter is connected correctly.   |
| ☎ (ADSL)     | On     | ADSL line is synchronized and ready to use.   |
|              | Flash  | The ADSL negotiation is in progress.  |
|              | Off    | ADSL synchronization fails. Please refer to <a href="#">Note 1</a> for troubleshooting.   |
| 🌐 (Internet) | On     | The network is available with a successful Internet connection.   |
|              | Flash  | There is data being transmitted or received via the Internet.   |
|              | Off    | There is no successful Internet connection or the modem router is operating in Bridge mode. Please refer to <a href="#">Note 2</a> for troubleshooting.   |
| 📶 (WLAN)     | On     | Wireless is enabled.  |
|              | Off    | Wireless function is disabled.  |
| 🔒 (WPS)      | On     | Wireless is enabled but no data is being transmitted.   |
|              | Flash  | WPS handshaking is in process and will continue for about 2 minutes. Please press the WPS button on other wireless devices that you want to add to the network while the LED is flashing.           |
|              | Off    | The WPS function is disabled or the wireless device fails to be added to the network in 2 minutes after WPS function is enabled. Please refer to <a href="#">WPS Settings</a> for more information. |
| 🖥 (LAN 1-4)  | On     | There is a device connected to this LAN port.   |
|              | Off    | There is no device connected to this LAN port.  |

#### Note:

1. If the ADSL LED is off, please check your Internet connection first. Refer to [2.4 Connecting the Modem Router](#) for more information about how to make Internet connection correctly. If you have already made a right connection, please contact your ISP to make sure if your Internet service is available now.

2. If the Internet LED is off, please check your ADSL LED first. If your ADSL LED is also off, please refer to **Note 1**. If your ADSL LED is GREEN ON, please check your Internet configuration. You may need to check this part of information with your ISP and make sure everything have been input correctly. Refer to [4.1.1 Device Info](#) and [4.3.1 Internet](#) for more information.

## 2.2 The Back Panel

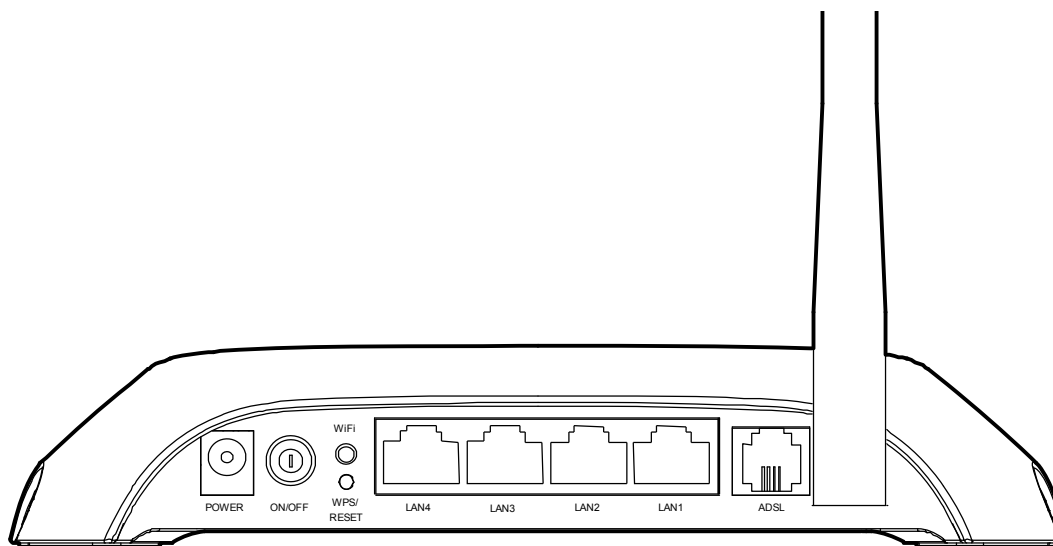

Figure 2-2

- **POWER:** The Power plug is where you will connect the power adapter.
- **ON/OFF:** The switch for the power.
- **WiFi:** Press this button to enable or disable Wireless LAN interface.
- **WPS/RESET:** The switch for the WPS function. If your client devices, such as wireless adapters, support Wi-Fi Protected Setup, then you can press this button for about two seconds to quickly establish a connection between the router and client devices and automatically configure wireless security for your wireless network. For details, please refer to [WPS Settings](#). If you press this button for more than 8 seconds, you will enable the RESET function. There are two ways to reset the modem router's factory defaults.
 

**Method one:** With the modem router powered on, press and hold down the **WPS/RESET** button on the rear panel for about 8 seconds until some LEDs go off, then release the button.

**Method two:** Restore the default setting from "Maintenance-SysRestart" of the modem router's Web-based Utility.
- **4, 3, 2, 1 (LAN):** Through the port, you can connect the modem router to your PC or the other Ethernet network devices.
- **ADSL:** Through the port, you can connect the modem router with the telephone. Or you can connect them by an external separate splitter. For details, please refer to [2.4 Connecting the Modem Router](#).
- **Antenna:** Used for wireless operation and data transmit.

## 2.3 Installation Environment

- The Product should not be located where it will be exposed to moisture or excessive heat.
- Place the modem router in a location where it can be connected to the various devices as well as to a power source.
- Make sure the cables and power cord are safely placed out of the way so they do not create a tripping hazard.
- The modem router can be placed on a shelf or desktop.
- Keep away from the strong electromagnetic radiation and the device of electromagnetic sensitive.

Generally, TD-W8901N is placed on a horizontal surface. The device also can be mounted on the wall as shown in Figure 2-3.

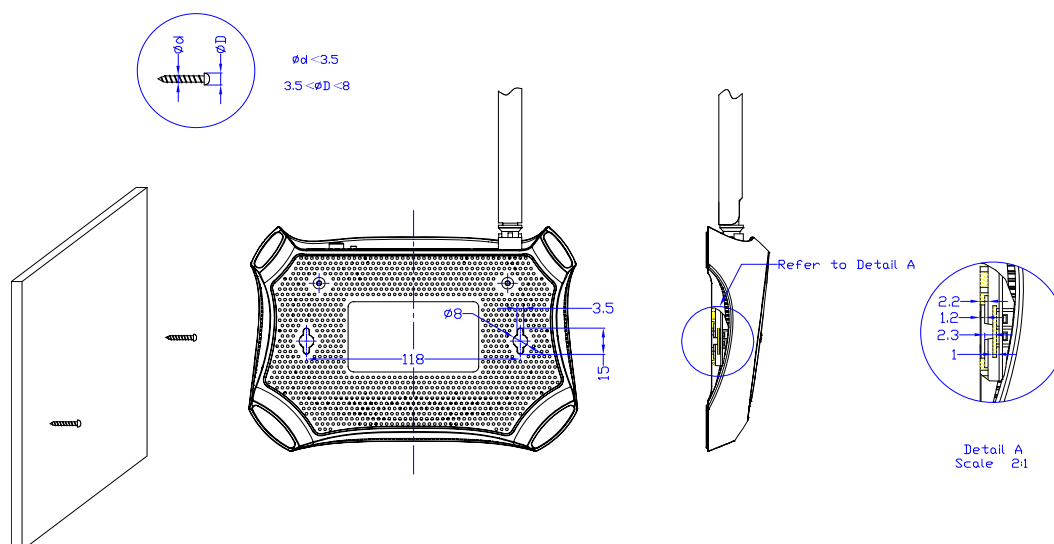

Figure 2-3 Wall-mount Install

### Note:

The diameter of the screw,  $3.5\text{mm} < D < 8\text{mm}$ , and the distance of two screws is 118mm. The screw that project from the wall need around 4mm based, and the length of the screw need to be at least 20mm to withstand the weight of the product.

## 2.4 Connecting the Modem Router

Before installing the device, please make sure your broadband service provided by your ISP is available. If there is any problem, please contact your ISP. Before cable connection, cut off the power supply and keep your hands dry. You can follow the steps below to install it.

**Step 1:** Connect the ADSL Line.

**Method one:** Plug one end of the twisted-pair ADSL cable into the ADSL port on the rear panel of TD-W8901N, and insert the other end into the wall socket.

**Method two:** You can use a separate splitter. External splitter can divide the data and voice, and then you can access the Internet and make calls at the same time. The external splitter has three ports:

- LINE: Connect to the wall jack
- PHONE: Connect to the phone sets
- MODEM: Connect to the ADSL port of TD-W8901N

Plug one end of the twisted-pair ADSL cable into the ADSL port on the rear panel of TD-W8901N. Connect the other end to the MODEM port of the external splitter.

**Step 2:** Connect the Ethernet cable. Attach one end of a network cable to your computer's Ethernet port or a regular hub/switch port, and the other end to the LAN port on the TD-W8901N.

**Step 3:** Power on the computers and LAN devices.

**Step 4:** Attach the power adapter. Connect the power adapter to the power connector on the rear of the device and plug in the adapter to an electrical outlet or power extension. The electrical outlet shall be installed near the device and shall be easily accessible.

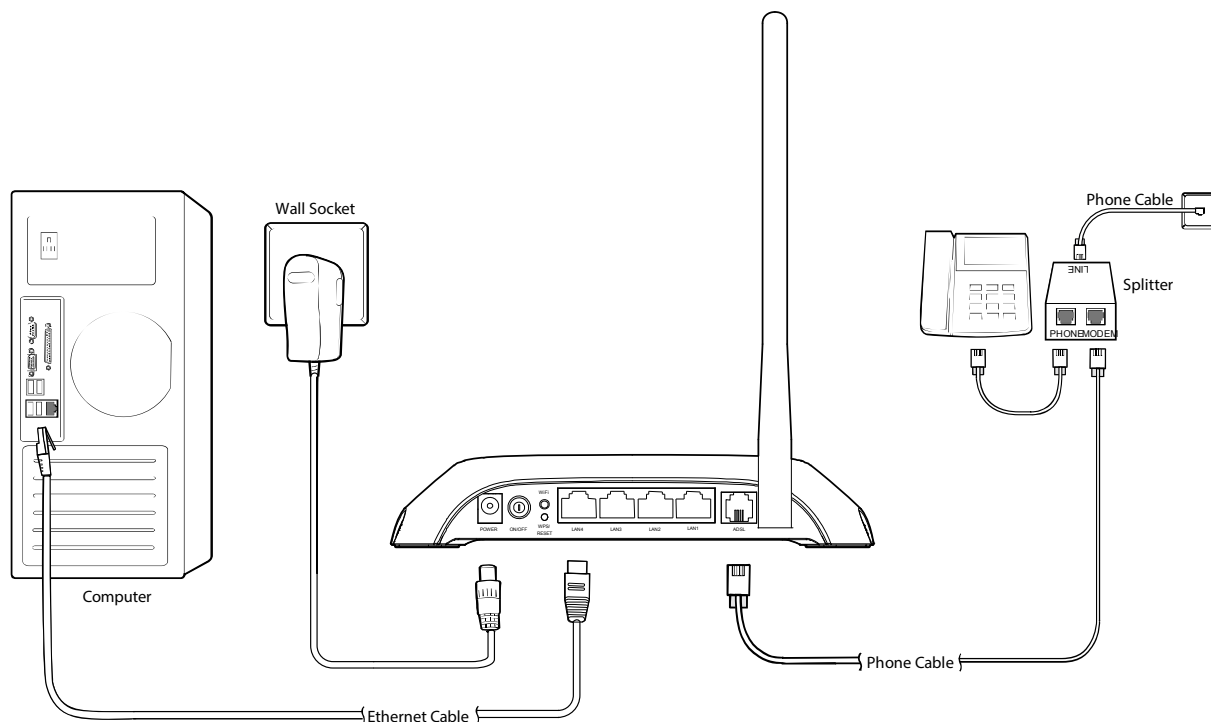

Figure 2-4

## Chapter 3. Quick Installation Guide

### 3.1 TCP/IP Configuration

The default IP address of the TD-W8901N 150Mbps Wireless N ADSL2+ Modem Router is 192.168.1.1. And the default Subnet Mask is 255.255.255.0. These values can be changed as you desire. In this guide, we use all the default values for description.

Connect the local PC to the LAN port of the Modem Router. And then you can configure your PC to an obtain IP address in the following way:

- 1) Set up the TCP/IP Protocol in "**Obtain an IP address automatically**" mode on your PC. If you need instructions as to how to do this, please refer to **T3** in [Appendix B: Troubleshooting](#).
- 2) Then the built-in DHCP server will assign IP address for the PC.

Now, you can run the Ping command in the command prompt to verify the network connection. Please click the **Start** menu on your desktop, select **run** tab, type **cmd** or **command** in the field and press **Enter**. Type **ping 192.168.1.1** on the next screen, and then press **Enter**.

If the result displayed is similar to the screen below, the connection between your PC and the modem router has been established.

```
Pinging 192.168.1.1 with 32 bytes of data:
Reply from 192.168.1.1: bytes=32 time<1ms TTL=64
Reply from 192.168.1.1: bytes=32 time<1ms TTL=64
Reply from 192.168.1.1: bytes=32 time<1ms TTL=64
Reply from 192.168.1.1: bytes=32 time<1ms TTL=64

Ping statistics for 192.168.1.1:
    Packets: Sent = 4, Received = 4, Lost = 0 (0% loss),
    Approximate round trip times in milli-seconds:
        Minimum = 0ms, Maximum = 0ms, Average = 0ms
```

Figure 3-1

If the result displayed is similar to the screen shown below, it means that your PC has not connected to the modem router.

```

Pinging 192.168.1.1 with 32 bytes of data:

Request timed out.
Request timed out.
Request timed out.
Request timed out.

Ping statistics for 192.168.1.1:
    Packets: Sent = 4, Received = 0, Lost = 4 (100% loss),

```

Figure 3-2

You can check it follow the steps below:

**1) Is the connection between your PC and the modem router correct?**

The LEDs of LAN port which you link to the device and the LEDs on your PC's adapter should be lit.

**2) Is the TCP/IP configuration for your PC correct?**

If the modem router's IP address is 192.168.1.1, your PC's IP address must be within the range of 192.168.1.2 ~ 192.168.1.254.

## 3.2 Login

Once your host PC is properly configured, please proceed as follows to use the Web-based Utility: Launch your web browser and enter **http://tplinkmodem.net** or **192.168.1.1** in the address bar.



Address http://tplinkmodem.net

After that, you will see the screen shown below, enter the default User Name **admin** and the default Password **admin**, and then click **Login** to access to the Web-Management page. You can follow the steps below to complete the Quick Start.

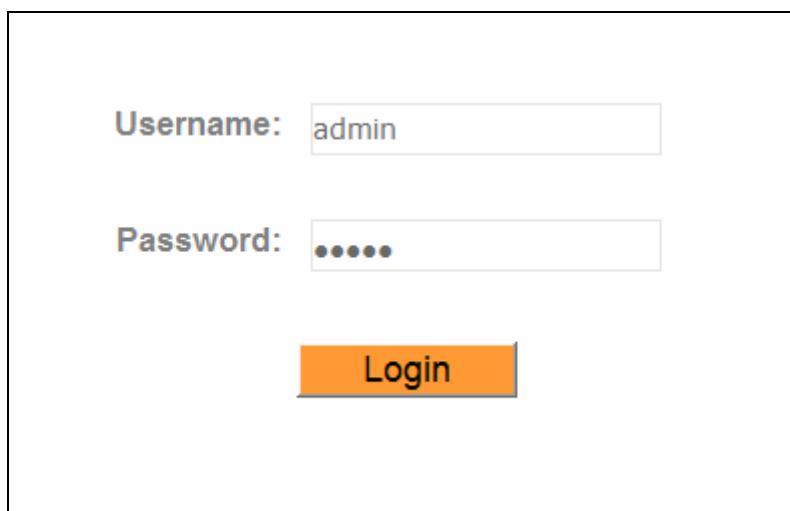

Username:

Password:

Figure 3-3



**Step 1:** Click **NEXT** to continue.

Figure 3-4

**Step 2:** Configure the time for the modem router, and then click **NEXT**.

Figure 3-5

**Step 3:** Select your country and ISP, and select your ISP Connection type (Here we take **PPPoE/PPPoA** mode for example), and complete the corresponding settings with the information provided by your ISP, then click the **NEXT** button.

Figure 3-6

 **Note:**

Per FCC regulations, all Wi-Fi products marketed in the U.S. must be fixed to the U.S. region only.

**Step 4:** After finishing the **Internet Settings**, configure the rules for the WLAN, and click **NEXT**.

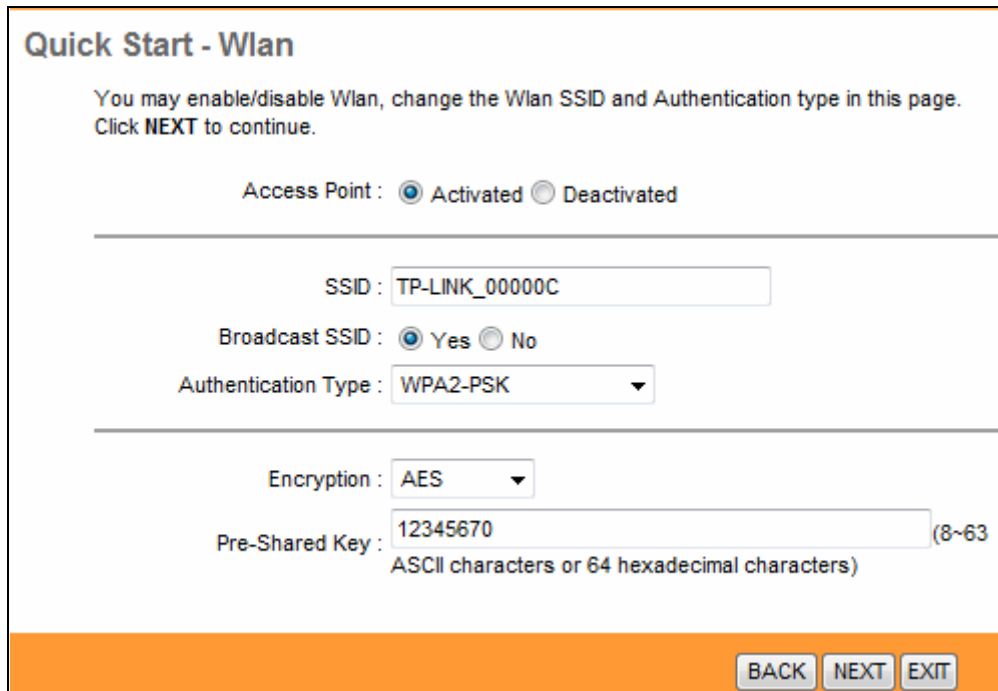

**Quick Start - Wlan**

You may enable/disable Wlan, change the Wlan SSID and Authentication type in this page. Click **NEXT** to continue.

Access Point :  Activated  Deactivated

SSID : TP-LINK\_00000C

Broadcast SSID :  Yes  No

Authentication Type : WPA2-PSK

Encryption : AES

Pre-Shared Key : 12345670 (8~63)  
ASCII characters or 64 hexadecimal characters)

BACK NEXT EXIT

Figure 3-7

 **Note:**

If the Access Point is activated, the wireless function will be available even without the external antenna because of an additional printed antenna. To adopt the wireless security protection measures, please refer to [4.3.3 Wireless](#).

**Step 5:** Click **SAVE** to finish the Quick Start.

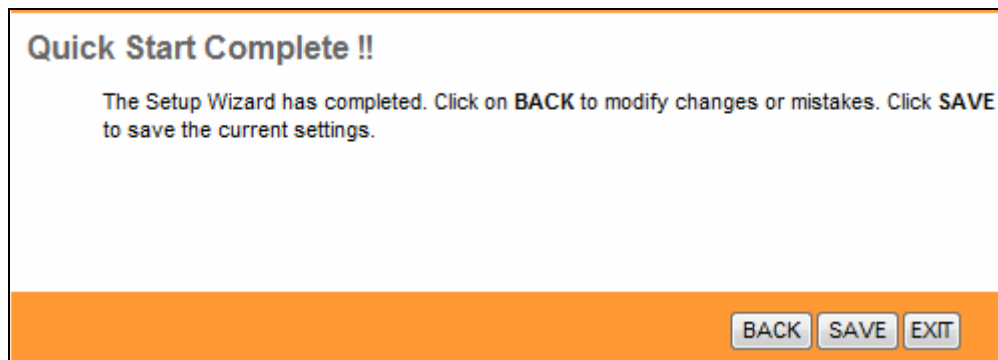

**Quick Start Complete !!**

The Setup Wizard has completed. Click on **BACK** to modify changes or mistakes. Click **SAVE** to save the current settings.

BACK SAVE EXIT

Figure 3-8

## Chapter 4. Software Configuration

This User Guide recommends using the “Quick Installation Guide” for first-time installation. For advanced users, if you want to know more about this device and make use of its functions adequately, maybe you will get help from this chapter to configure the advanced settings through the Web-based Utility.

After your successful login, you can configure and manage the device. There are main menus on the top of the Web-based Utility; submenus will be available after you click one of the main menus. On the center of the Web-based Utility, there are the detailed configurations or status information. To apply any settings you have altered on the page, please click the **SAVE** button.

### 4.1 Status

Choose “**Status**”, you can see the next submenus: **Device Info**, **System Log** and **Statistics**. Click any of them, and you will be able to configure the corresponding function.



Figure 4-1

Click any of them, and you will be able to view the corresponding information.

#### 4.1.1 Device Info

Choose “**Status**→**Device Info**” menu, and you will be able to view the device information, including LAN, WAN and ADSL. The information will vary depending on the settings of the modem router configured on the Interface Setup screen.

**TP-LINK®** 150Mbps Wireless N ADSL2+ Modem Router

Quick Start | Interface Setup | Advanced Setup | Access Management | Maintenance | **Status** | Help

Device Info | System Log | Statistics

**Device Information**  
 Firmware Version : 3.0.0 Build 150717 Rel.28109  
 MAC Address : d8:5d:4c:00:00:0c

**LAN**  
 IP Address : 192.168.1.1  
 Subnet Mask : 255.255.255.0  
 DHCP Server : Enabled

**Wireless**  
 Current Connected Wireless Clients number is 0

| ID | MAC |
|----|-----|
|    |     |

**WAN**

| PVC  | VP/VC | IP Address | Subnet  | GateWay | DNS Server | Encapsulation | Status |
|------|-------|------------|---------|---------|------------|---------------|--------|
| PVC0 | 1/32  | N/A        | N/A     | N/A     | N/A        | Bridge        | Down   |
| PVC1 | 0/33  | N/A        | N/A     | N/A     | N/A        | Bridge        | Down   |
| PVC2 | 0/35  | N/A        | N/A     | N/A     | N/A        | Bridge        | Down   |
| PVC3 | 0/100 | N/A        | N/A     | N/A     | N/A        | Bridge        | Down   |
| PVC4 | 8/35  | 0.0.0.0    | 0.0.0.0 | 0.0.0.0 | 0.0.0.0    | PPPoE         | Down   |
| PVC5 | 8/48  | N/A        | N/A     | N/A     | N/A        | Bridge        | Down   |
| PVC6 | 0/38  | N/A        | N/A     | N/A     | N/A        | Bridge        | Down   |

**ADSL**  
 ADSL Firmware Version : FwVer:3.24.13.0\_MT7550 HwVer:T14.F7\_13.0  
 Line State : Down  
 Modulation : N/A  
 Annex Mode : N/A

|                    | Downstream | Upstream |      |
|--------------------|------------|----------|------|
| SNR Margin :       | N/A        | N/A      | db   |
| Line Attenuation : | N/A        | N/A      | db   |
| Data Rate :        | N/A        | N/A      | kbps |
| Max Rate :         | N/A        | N/A      | kbps |
| POWER :            | N/A        | N/A      | dbm  |
| CRC :              | N/A        | N/A      |      |

Figure 4-2

**Note:**

Click the other submenus **System Log** or **Statistics** in Figure 4-2, and you will be able to view the system log and traffic statistics about the modem router.

### 4.1.2 System Log

Choose “**Status**→**System Log**” menu, and you will be able to query the logs of the modem router.

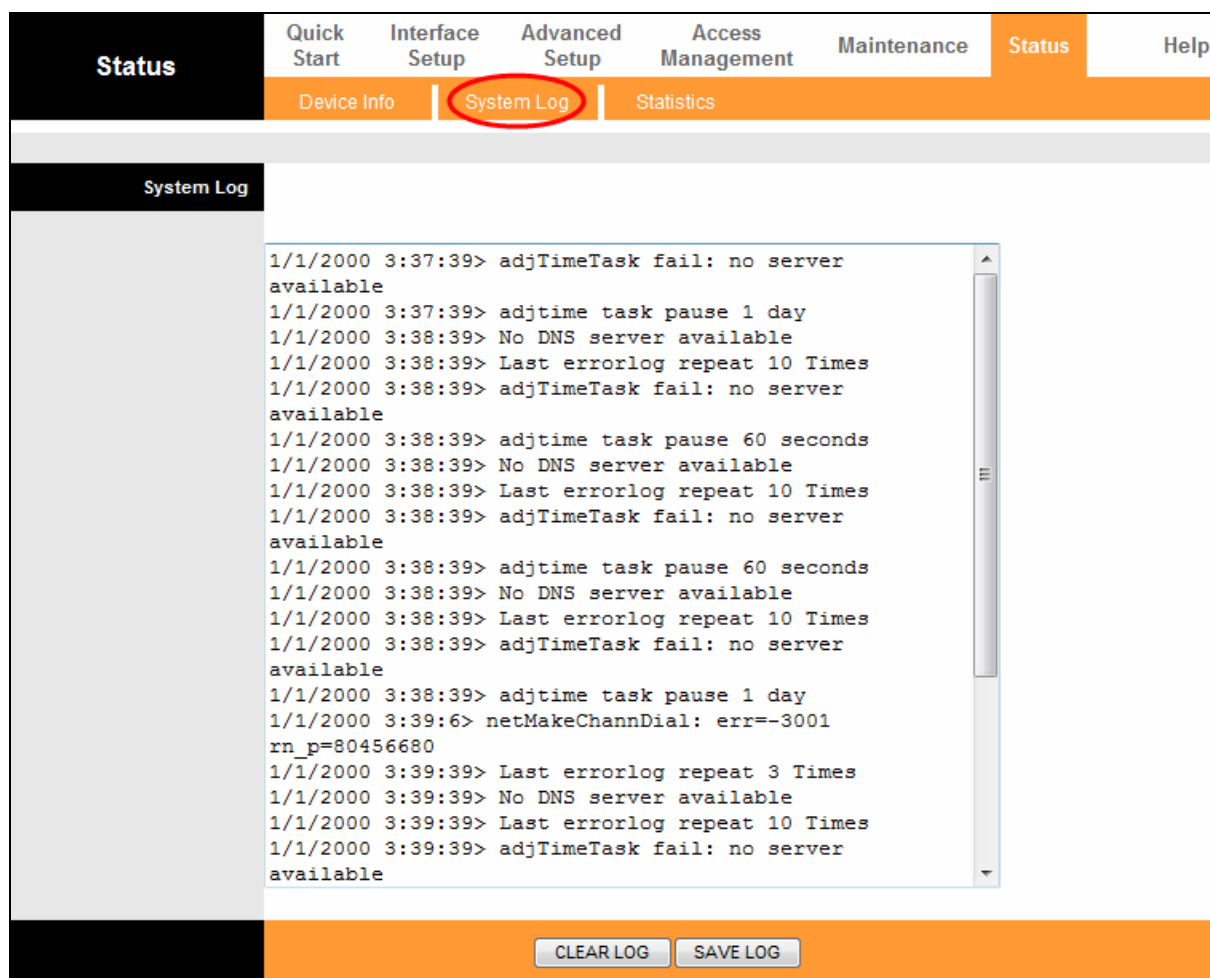

Figure 4-3

The modem router can keep logs of all traffic. You can query the logs to find what happened to the Router.

Click the **CLEAR LOG** button to clear the logs.

Click the **SAVE LOG** button to save the logs.

### 4.1.3 Statistics

Choose “**Status**→**Statistics**” menu, and you will be able to view the network traffic over Ethernet, ADSL and WLAN.

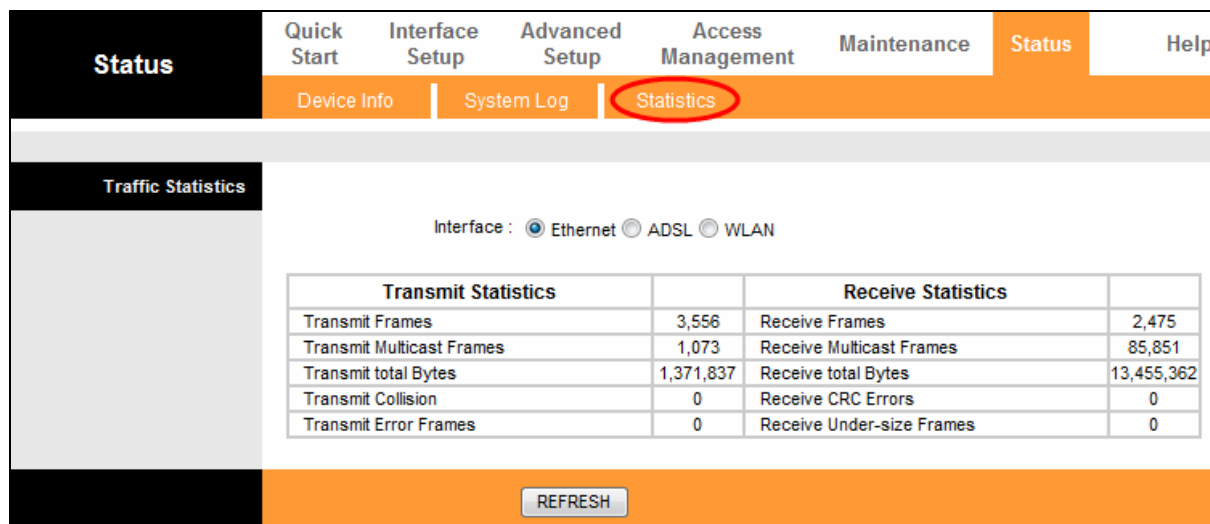

Figure 4-4

- **Interface:** You can select **Ethernet**, **ADSL** and **WLAN** to view the corresponding network traffic over different ports.
- Select **Ethernet**, and you will see the statistics table as below.

| Interface : <input checked="" type="radio"/> Ethernet <input type="radio"/> ADSL <input type="radio"/> WLAN |           |                           |            |
|---|-----------|---------------------------|------------|
| Transmit Statistics   |           | Receive Statistics        |            |
| Transmit Frames   | 3,556     | Receive Frames            | 2,475      |
| Transmit Multicast Frames   | 1,073     | Receive Multicast Frames  | 85,851     |
| Transmit total Bytes  | 1,371,837 | Receive total Bytes       | 13,455,362 |
| Transmit Collision  | 0         | Receive CRC Errors        | 0          |
| Transmit Error Frames   | 0         | Receive Under-size Frames | 0          |

**Statistics Table:**

|                            |                                  |   |
|----------------------------|----------------------------------|---|
| <b>Transmit Statistics</b> | <b>Transmit Frames</b>           | The frames transmitted over the Ethernet port.                                |
|                            | <b>Transmit Multicast Frames</b> | The multicast frames transmitted over the Ethernet port.                      |
|                            | <b>Transmit total Bytes</b>      | The total bytes transmitted over the Ethernet port.                           |
|                            | <b>Transmit Collision</b>        | The collision occurred over the Ethernet port when data is being transmitted. |
|                            | <b>Transmit Error Frames</b>     | The error frames over the Ethernet port when data is being transmitted.       |
| <b>Receive Statistics</b>  | <b>Receive Frames</b>            | The frames received over the Ethernet port.                                   |
|                            | <b>Receive Multicast Frames</b>  | The multicast frames received over the Ethernet port.                         |
|                            | <b>Receive total Bytes</b>       | The total bytes received over the Ethernet port.                              |
|                            | <b>Receive CRC Errors</b>        | The CRC errors occurred over the Ethernet port when data is being received.   |

|  |                                  |  |
|--|----------------------------------|--|
|  | <b>Receive Under-size Frames</b> | The Under-size frames received over the Ethernet port. |
|--|----------------------------------|--|

➤ Select **ADSL**, and you will see the statistics table as below.

|   |   |                            |   |
|---|---|----------------------------|---|
| Interface : <input type="radio"/> Ethernet <input checked="" type="radio"/> ADSL <input type="radio"/> WLAN |   |                            |   |
| <b>Transmit Statistics</b>  |   | <b>Receive Statistics</b>  |   |
| Transmit total PDUs   | 0 | Receive total PDUs         | 0 |
| Transmit total Error Counts   | 0 | Receive total Error Counts | 0 |

**Statistics Table:**

|                            |                                    |  |
|----------------------------|------------------------------------|--|
| <b>Transmit Statistics</b> | <b>Transmit total PDUs</b>         | The total PDUs transmitted over the ADSL port.                               |
|                            | <b>Transmit total Error Counts</b> | The total errors occurred over the ADSL port when data is being transmitted. |
| <b>Receive Statistics</b>  | <b>Receive total PDUs</b>          | The total PDUs transmitted over the ADSL port.                               |
|                            | <b>Receive total Error Counts</b>  | The total errors occurred over the ADSL port when data is being received.    |

➤ Select **WLAN**, and you will see the statistics table as below.

|   |        |                           |         |
|---|--------|---------------------------|---------|
| Interface : <input type="radio"/> Ethernet <input type="radio"/> ADSL <input checked="" type="radio"/> WLAN |        |                           |         |
| <b>Transmit Statistics</b>  |        | <b>Receive Statistics</b> |         |
| Tx Frames Count   | 13,185 | Rx Frames Count           | 975,471 |
| Tx Errors Count   | 0      | Rx Errors Count           | 534,641 |
| Tx Drops Count  | 0      | Rx Drops Count            | 534,641 |

**Statistics Table:**

|                            |                        |   |
|----------------------------|------------------------|---|
| <b>Transmit Statistics</b> | <b>Tx Frames Count</b> | The frames transmitted over the WLAN when wireless data is being transmitted. |
|                            | <b>Tx Errors Count</b> | The errors occurred over the WLAN when wireless data is being transmitted.    |
|                            | <b>Tx Drops Count</b>  | The drops occurred over the WLAN when wireless data is being transmitted.     |
| <b>Receive Statistics</b>  | <b>Rx Frames Count</b> | The frames received over the WLAN when wireless data is being transmitted.    |
|                            | <b>Rx Errors Count</b> | The errors occurred over the WLAN when wireless data is being received.       |
|                            | <b>Rx Drops Count</b>  | The drops occurred over the WLAN when wireless data is being received.        |

Click the **REFRESH** button to refresh immediately.

## 4.2 Quick Start

Please refer to [3.2 Login](#).

## 4.3 Interface Setup

Choose “**Interface Setup**”, you can see the next submenus:.

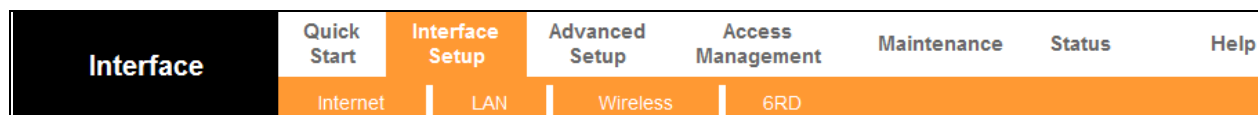

Figure 4-5

Click any of them, and you will be able to configure the corresponding function.

### 4.3.1 Internet

Choose “**Interface Setup**→**Internet**” menu, you can configure the parameters for WAN ports in the next screen (shown in Figure 4-6).



| Interface   | Quick Start   | Interface Setup | Advanced Setup | Access Management | Maintenance | Status | Help |
|---|---|-----------------|----------------|-------------------|-------------|--------|------|
|   | Internet  | LAN             | Wireless       | 6RD               |             |        |      |
| <b>ATM VC</b>   | Virtual Circuit : PVC0 <input type="button" value="PVCs Summary"/>  |                 |                |                   |             |        |      |
| QoS   | Status : <input checked="" type="radio"/> Activated <input type="radio"/> Deactivated   |                 |                |                   |             |        |      |
|   | VPI : 1 (range: 0~255)  |                 |                |                   |             |        |      |
|   | VCI : 32 (range: 32~65535)  |                 |                |                   |             |        |      |
| IPv4/IPv6   | ATM QoS : UBR   |                 |                |                   |             |        |      |
|   | PCR : 0 cells/second  |                 |                |                   |             |        |      |
|   | SCR : 0 cells/second  |                 |                |                   |             |        |      |
|   | MBS : 0 cells   |                 |                |                   |             |        |      |
| Encapsulation   | IP Version : <input checked="" type="radio"/> IPv4 <input type="radio"/> IPv4/IPv6 <input type="radio"/> IPv6   |                 |                |                   |             |        |      |
|   | ISP : <input type="radio"/> Dynamic IP Address<br><input type="radio"/> Static IP Address<br><input checked="" type="radio"/> PPPoA/PPPoE<br><input type="radio"/> Bridge Mode  |                 |                |                   |             |        |      |
| PPPoE/PPPoA   | Servicename : <input type="text"/>  |                 |                |                   |             |        |      |
|   | Username : <input type="text"/>   |                 |                |                   |             |        |      |
|   | Password : <input type="text"/>   |                 |                |                   |             |        |      |
| Connection Setting  | Encapsulation : PPPoE LLC   |                 |                |                   |             |        |      |
|   | Bridge Interface : <input type="radio"/> Activated <input checked="" type="radio"/> Deactivated   |                 |                |                   |             |        |      |
|   | Connection : <input checked="" type="radio"/> Always On (Recommended)<br><input type="radio"/> Connect On-Demand (Close if idle for <input type="text" value="0"/> minutes)<br><input type="radio"/> Connect Manually |                 |                |                   |             |        |      |
| IP Common Options   | TCP MSS Option : TCP MSS(default:1400) <input type="text" value="1400"/> bytes  |                 |                |                   |             |        |      |
|   | Default Route : <input checked="" type="radio"/> Yes <input type="radio"/> No   |                 |                |                   |             |        |      |
| IPv4 Address  | Get IP Address : <input type="radio"/> Static <input checked="" type="radio"/> Dynamic  |                 |                |                   |             |        |      |
|   | Static IP Address : <input type="text" value="0.0.0.0"/>  |                 |                |                   |             |        |      |
|   | IP Subnet Mask : <input type="text" value="0.0.0.0"/>   |                 |                |                   |             |        |      |
|   | Gateway : <input type="text" value="0.0.0.0"/>  |                 |                |                   |             |        |      |
|   | TCP MTU Option : TCP MTU(default:1480) <input type="text" value="1480"/> bytes  |                 |                |                   |             |        |      |
|   | NAT : Enable  |                 |                |                   |             |        |      |
|   | Dynamic Route : RIP2-B      Direction : Both  |                 |                |                   |             |        |      |
| Multicast : IGMP v2   |   |                 |                |                   |             |        |      |
| <input type="button" value="SAVE"/> <input type="button" value="DELETE"/> |   |                 |                |                   |             |        |      |

Figure 4-6

- **ATM VC:** ATM settings are used to connect to your ISP. Your ISP provides VPI (Virtual Path Identifier), VCI (Virtual Channel Identifier) settings to you. In this Device, you can totally setup 8 VCs on different encapsulations, if you apply 8 different virtual circuits from your ISP. You

need to activate the VC to take effect. For PVCs management, you can use ATM QoS to setup each PVC traffic line's priority.

- **Virtual Circuit:** Select the VC number you want to setup, PVC0~PVC7.
- **PVCs Summary:** Click the button, and you can view the summary information about the PVCs.
- **Status:** If you want to use a designed VC, you should activate it.
- **VPI:** Identifies the virtual path between endpoints in an ATM network. The valid range is from 0 to 255. Please input the value provided by your ISP.
- **VCI:** Identifies the virtual channel endpoints in an ATM network. The valid range is from 32 to 65535 (1 to 31 is reserved for well-known protocols). Please input the value provided by your ISP.
- **QoS:** Select the Quality of Service types for this Virtual Circuit, including CBR (Constant Bit Rate), UBR (Unspecified Bit Rate) and VBR (Variable Bit Rate). These QoS types are all controlled by the parameters specified below, including PCR (Peak Cell Rate), SCR (Sustained Cell Rate) and MBS (Maximum Burst Size), please configure them according to your needs.

#### 4.3.1.1 IPv4

There are two IP versions: IPv4 and IPv6. If you select IPv4 as IP version, please follow the configuration below to configure the parameters for WAN ports.

- **Encapsulation:** There are four connection types: Dynamic IP Address, Static IP Address, PPPoA/PPPoE and Bridge Mode. Please choose the designed type that you want to use. After that, you should follow the configuration below to proceed.

##### 1) Dynamic IP Address

Select this option if your ISP provides you an IP address automatically. This option is typically used for Cable services. Please enter the Dynamic IP information accordingly.

|                   |  |
|-------------------|--|
| IPv4/IPv6         | IP Version : <input checked="" type="radio"/> IPv4 <input type="radio"/> IPv4/IPv6 <input type="radio"/> IPv6  |
| Encapsulation     | ISP : <input checked="" type="radio"/> Dynamic IP Address<br><input type="radio"/> Static IP Address<br><input type="radio"/> PPPoA/PPPoE<br><input type="radio"/> Bridge Mode   |
| Dynamic IP        |  |
| IP Common Options | Encapsulation : 1483 Bridged IP LLC<br>Bridge Interface : <input type="radio"/> Activated <input checked="" type="radio"/> Deactivated<br>Default Route : <input checked="" type="radio"/> Yes <input type="radio"/> No<br>TCP MTU Option : TCP MTU(default:1500) 1500 bytes |
| IPv4 Address      | NAT : Enable<br>Dynamic Route : RIP2-B      Direction : Both<br>Multicast : IGMP v2  |

Figure 4-7

- **Encapsulation:** Select the encapsulation mode for the Dynamic IP Address, you can leave it default.
- **Bridge Interface:** Activate the option, the modem router can also work in Bridge mode.
- **Default Route:** If enable this function, the current PVC will be considered as the default gateway to Internet from this device.
- **TCP MTU Option:** Enter the TCP MTU as your desire. The default value is 1500.
- **IPv4 Address:** If you select IPv4 as IP version, you should configure the following.
- **NAT:** Select this option to Enable/Disable the NAT (Network Address Translation) function for this VC. The NAT function can be activated or deactivated per PVC basis.
- **Dynamic Route:** Select this option to specify the RIP (Routing Information protocol) version for WAN interface, including **RIP1**, **RIP2-B** and **RIP2-M**. RIP2-B and RIP2-M are both sent in RIP2 format, the difference is that RIP2-M using Multicast, while RIP2-B using Broadcast format.
- **Direction:** Select this option to specify the RIP direction. **None** is for disabling the RIP function. **Both** means the ADSL modem router will periodically send routing information and accept routing information, and then incorporate them into routing table. **IN only** means the ADSL modem router will only accept but will not send RIP packet. **OUT only** means the ADSL modem router will only send but will not accept RIP packet.
- **Multicast:** Select IGMP version, or disable the function. IGMP (Internet Group Multicast Protocol) is a session-layer protocol used to establish membership in a multicast group. The ADSL ATU-R supports IGMP version 1 (**IGMP v1**), IGMP version 2 (**IGMP v2**) and IGMP version 3 (**IGMP v3**). Select "Disabled" to disable it.

## 2) Static IP Address

Select this option if your ISP provides static IP information for you. You should set static IP address, IP Subnet Mask, and Gateway address in the screen below (shown in Figure 4-8).

|                      |   |
|----------------------|---|
| <b>IPv4/IPv6</b>     | IP Version : <input checked="" type="radio"/> IPv4 <input type="radio"/> IPv4/IPv6 <input type="radio"/> IPv6   |
| <b>Encapsulation</b> | ISP : <input type="radio"/> Dynamic IP Address<br><input checked="" type="radio"/> Static IP Address<br><input type="radio"/> PPPoA/PPPoE<br><input type="radio"/> Bridge Mode  |
| <b>Static IP</b>     | IP Common Options<br>Encapsulation : 1483 Bridged IP LLC<br>Bridge Interface : <input type="radio"/> Activated <input checked="" type="radio"/> Deactivated<br>Default Route : <input checked="" type="radio"/> Yes <input type="radio"/> No<br>TCP MTU Option : TCP MTU(default:1500) 1500 bytes |
| <b>IPv4 Options</b>  | Static IP Address : 0.0.0.0<br>IP Subnet Mask : 0.0.0.0<br>Gateway : 0.0.0.0<br>NAT : Enable<br>Dynamic Route : RIP2-B      Direction : Both<br>Multicast : IGMP v2   |

Figure 4-8

**Note:**

Each IP address entered in the fields must be in the appropriate IP form, which is four IP octets separated by a dot (x.x.x.x), such as 192.168.1.100. The modem router will not accept the IP address if it is not in this format.

**3) PPPoA/PPPoE**

Select this option if your ISP requires you to use a PPPoE connection. This option is typically used for DSL services. Select Dynamic PPPoE to obtain an IP address automatically for your PPPoE connection. Select Static PPPoE to use a static IP address for your PPPoE connection. Please enter the information accordingly.

|                    |   |
|--------------------|---|
| IPv4/IPv6          | IP Version : <input checked="" type="radio"/> IPv4 <input type="radio"/> IPv4/IPv6 <input type="radio"/> IPv6   |
| Encapsulation      | ISP : <input type="radio"/> Dynamic IP Address<br><input type="radio"/> Static IP Address<br><input checked="" type="radio"/> PPPoA/PPPoE<br><input type="radio"/> Bridge Mode  |
| PPPoE/PPPoA        | Servicename : <input type="text"/><br>Username : <input type="text"/><br>Password : <input type="text"/><br>Encapsulation : PPPoE LLC<br>Bridge Interface : <input type="radio"/> Activated <input checked="" type="radio"/> Deactivated  |
| Connection Setting | Connection : <input checked="" type="radio"/> Always On (Recommended)<br><input type="radio"/> Connect On-Demand (Close if idle for <input type="text" value="0"/> minutes)<br><input type="radio"/> Connect Manually<br>TCP MSS Option : TCP MSS(default:1400) <input type="text" value="1400"/> bytes   |
| IP Common Options  | Default Route : <input checked="" type="radio"/> Yes <input type="radio"/> No   |
| IPv4 Address       | Get IP Address : <input type="radio"/> Static <input checked="" type="radio"/> Dynamic<br>Static IP Address : <input type="text" value="0.0.0.0"/><br>IP Subnet Mask : <input type="text" value="0.0.0.0"/><br>Gateway : <input type="text" value="0.0.0.0"/><br>TCP MTU Option : TCP MTU(default:1480) <input type="text" value="1480"/> bytes<br>NAT : Enable<br>Dynamic Route : RIP2-B Direction : Both<br>Multicast : IGMP v2 |

Figure 4-9

- **Service name:** Specify a name for the PPPoA/PPPoE connection for recognition.
- **Username:** Enter your username for your PPPoA/PPPoE connection to identify and verify your account to the ISP.
- **Password:** Enter your password for your PPPoA/PPPoE connection.
- **Encapsulation:** For both PPPoA/PPPoE connection, you need to specify the type of Multiplexing, either LLC or VC Mux.
- **Bridge Interface:** Activate the option, the modem router can also work in Bridge mode.
- **Connection:** For PPPoA/PPPoE connection, you can select **Always on** or **Connect on-Demand** or **Connect Manually**. Connect on demand is dependent on the traffic. If there is no traffic (or **Idle**) for a pre-specified period of time, the connection will drop down automatically. And once there is traffic send or receive, the connection will be automatically on.
- **Default Route:** You should select **Yes** to configure the PVC as the default gateway to Internet from this device.
- **Static/Dynamic IP Address:** For PPPoA/PPPoE connection, you need to specify the public IP address for this ADSL modem router. The IP address can be either dynamically (via DHCP)

or given by your ISP. For Static IP, you need to specify the IP address, Subnet Mask and Gateway IP address.

#### 4) Bridge Mode

If you select this type of connection, the modem router can be configured to act as a bridging device between your LAN and your ISP. Bridges are devices that enable two or more networks to communicate as if they are two segments of the same physical LAN.

The screenshot shows a configuration interface with three main sections on the left: 'IPv4/IPv6', 'Encapsulation', and 'Bridge Mode'. The 'Bridge Mode' section is currently active. In the 'IP Version' field, 'IPv4' is selected with a radio button. The 'ISP' section has four radio button options: 'Dynamic IP Address', 'Static IP Address', 'PPPoA/PPPoE', and 'Bridge Mode', with 'Bridge Mode' being the selected option. At the bottom, the 'Encapsulation' dropdown menu is set to '1483 Bridged IP LLC'.

Figure 4-10

**Note:**

After you finish the Internet configuration, please click **SAVE** to make the settings take effect.

#### 4.3.1.2 IPv6

If you select IPv6 as IP version, please follow the configuration below to configure the parameters for WAN ports.

- **Encapsulation:** There are four connection types: Dynamic IP Address, Static IP Address, PPPoA/PPPoE and Bridge Mode. Please choose the designed type that you want to use. After that, you should follow the configuration below to proceed.

##### 1) Dynamic IP Address

Select this option if your ISP provides you an IP address automatically. This option is typically used for Cable services. Please enter the Dynamic IP information accordingly.

|                 |   |
|-----------------|---|
| IPv4/IPv6       | IP Version : <input type="radio"/> IPv4 <input type="radio"/> IPv4/IPv6 <input checked="" type="radio"/> IPv6   |
| Encapsulation   | ISP : <input checked="" type="radio"/> Dynamic IP Address<br><input type="radio"/> Static IP Address<br><input type="radio"/> PPPoA/PPPoE<br><input type="radio"/> Bridge Mode  |
| Dynamic IP      | <p>IP Common Options</p> <p>Encapsulation : 1483 Bridged IP LLC</p> <p>Bridge Interface : <input type="radio"/> Activated <input checked="" type="radio"/> Deactivated</p> <p>Default Route : <input checked="" type="radio"/> Yes <input type="radio"/> No</p> <p>TCP MTU Option : TCP MTU(default:1500) <input type="text" value="1500"/> bytes</p> |
| IPv6 Address    | <p>IPv6 Message Fetch Type : Dynamic Mode</p> <p>DHCP IPv6 Enable : <input checked="" type="radio"/> DHCP <input type="radio"/> SLAAC</p> <p>DHCP PD Enable : <input checked="" type="radio"/> Enable <input type="radio"/> Disable</p> <p>MLD Proxy : <input checked="" type="radio"/> Enable <input type="radio"/> Disable</p>                      |
| Dual Stack Lite | Enable : <input type="radio"/> Enable <input checked="" type="radio"/> Disable  |

Figure 4-11

- **IP Common Option:** Configure the IP common option here.
- **Encapsulation:** Select the encapsulation mode for the Dynamic IP Address, you can leave it default.
- **Bridge Interface:** Activate the option, the modem router can also work in Bridge mode.
- **Default Route:** If enable this function, the current PVC will be considered as the default gateway to Internet from this device.
- **TCP MTU Option:** Enter the TCP MTU as your desire. The default value is 1500.
- **DHCP IPv6:** There are two types of assignation for IPv6 address: DHCP (Dynamic Host Configuration Protocol) Server and SLAAC (Stateless address auto-configuration). Select your assignation type accordingly.
- **DHCP PD:** The DHCP PD (Prefix Delegation) function is enabled by default. If you want to disable the function, please click **Disable**.
- **MLD Proxy:** The MLD (Multicast Listener Discovery Protocol) Proxy function is enabled by default. If you want to disable the function, please click **Disable**.

## 2) Static IP Address

Select this option if your ISP provides static IP information for you. You should set static IP address, IP Default Gateway and DNS Server address in the screen below (shown in Figure 4-12).

|                   |  |
|-------------------|--|
| IPv4/IPv6         | IP Version : <input type="radio"/> IPv4 <input type="radio"/> IPv4/IPv6 <input checked="" type="radio"/> IPv6  |
| Encapsulation     | ISP : <input type="radio"/> Dynamic IP Address<br><input checked="" type="radio"/> Static IP Address<br><input type="radio"/> PPPoA/PPPoE<br><input type="radio"/> Bridge Mode   |
| Static IP         |  |
| IP Common Options | Encapsulation : 1483 Bridged IP LLC<br>Bridge Interface : <input type="radio"/> Activated <input checked="" type="radio"/> Deactivated<br>Default Route : <input checked="" type="radio"/> Yes <input type="radio"/> No<br>TCP MTU Option : TCP MTU(default:1500) 1500 bytes |
| IPv6 Options      | IPv6 Message Fetch Type : Static Mode<br>IPv6 Address : :: / 0<br>IPv6 Default Gateway : ::<br>IPv6 DNS Server1 : ::<br>IPv6 DNS Server2 : ::<br>MLD Proxy : <input checked="" type="radio"/> Enable <input type="radio"/> Disable   |
| Dual Stack Lite   | Enable : <input type="radio"/> Enable <input checked="" type="radio"/> Disable   |

Figure 4-12

**Note:**

Each IP address entered in the fields must be in the appropriate IPv6 form, which is eight IP octets separated by a colon (x:x:x:x:x:x:x). The modem router will not accept the IP address if it is not in this format.

**3) PPPoA/PPPoE**

Select this option if your ISP requires you to use a PPPoE connection. This option is typically used for DSL services. Select Dynamic PPPoE to obtain an IP address automatically for your PPPoE connection. Select Static PPPoE to use a static IP address for your PPPoE connection. Please enter the information accordingly.



|                    |   |
|--------------------|---|
| IPv4/IPv6          | IP Version : <input type="radio"/> IPv4 <input type="radio"/> IPv4/IPv6 <input checked="" type="radio"/> IPv6   |
| Encapsulation      | ISP : <input type="radio"/> Dynamic IP Address<br><input type="radio"/> Static IP Address<br><input checked="" type="radio"/> PPPoA/PPPoE<br><input type="radio"/> Bridge Mode  |
| PPPoE/PPPoA        | Servicename : <input type="text"/><br>Username : <input type="text"/><br>Password : <input type="text"/><br>Encapsulation : PPPoE LLC<br>Bridge Interface : <input type="radio"/> Activated <input checked="" type="radio"/> Deactivated  |
| Connection Setting | Connection : <input checked="" type="radio"/> Always On (Recommended)<br><input type="radio"/> Connect On-Demand (Close if idle for <input type="text" value="0"/> minutes)<br><input type="radio"/> Connect Manually<br>TCP MSS Option : TCP MSS(default:1400) <input type="text" value="1400"/> bytes |
| IP Common Options  | Default Route : <input checked="" type="radio"/> Yes <input type="radio"/> No   |
| IPv6 Address       | DHCP IPv6 Enable : <input checked="" type="radio"/> DHCP <input type="radio"/> SLAAC<br>DHCP PD Enable : <input checked="" type="radio"/> Enable <input type="radio"/> Disable<br>MLD Proxy : <input checked="" type="radio"/> Enable <input type="radio"/> Disable                                     |
| Dual Stack Lite    | Enable : <input type="radio"/> Enable <input checked="" type="radio"/> Disable  |

Figure 4-13

- **Service name:** Specify a name for the PPPoA/PPPoE connection for recognition.
- **Username:** Enter your username for your PPPoA/PPPoE connection to identify and verify your account to the ISP.
- **Password:** Enter your password for your PPPoA/PPPoE connection.
- **Encapsulation:** For both PPPoA/PPPoE connection, you need to specify the type of Multiplexing, either LLC or VC Mux.
- **Bridge Interface:** Activate the option, the modem router can also work in Bridge mode.
- **Connection:** For PPPoA/PPPoE connection, you can select **Always on** or **Connect on-Demand** or **Connect Manually**. Connect on demand is dependent on the traffic. If there is no traffic (or **Idle**) for a pre-specified period of time, the connection will drop down automatically. And once there is traffic send or receive, the connection will be automatically on.
- **TCP MSS Option:** Enter the TCP MSS as your desire. The default value is 1400.
- **Default Route:** You should select **Yes** to configure the PVC as the default gateway to Internet from this device.
- **DHCP IPv6:** There are two types of assignation for IPv6 address: DHCP (Dynamic Host Configuration Protocol) Server and SLAAC (Stateless address auto-configuration). Select your assignation type accordingly.

- **DHCP PD:** The DHCP PD (Prefix Delegation) function is enabled by default. If you want to disable the function, please click **Disable**.
- **MLD Proxy:** The MLD (Multicast Listener Discovery Protocol) Proxy function is enabled by default. If you want to disable the function, please click **Disable**.
- **Dual Stack Lite:** Enable the Dual Stack Lite (D-S Lite) function if you need. It is disabled by default.

#### 4) Bridge Mode

If you select this type of connection, the modem router can be configured to act as a bridging device between your LAN and your ISP. Bridges are devices that enable two or more networks to communicate as if they are two segments of the same physical LAN.

- **Dual Stack Lite:** Enable the Dual Stack Lite (D-S Lite) function if you need. It is disabled by default.

The screenshot shows a configuration page with a sidebar on the left containing the following menu items: IPv4/IPv6, Encapsulation, Dual Stack Lite, and Bridge Mode. The main content area is divided into sections:

- IP Version:** Radio buttons for IPv4, IPv4/IPv6, and IPv6. IPv6 is selected.
- ISP:** Radio buttons for Dynamic IP Address, Static IP Address, PPPoA/PPPoE, and Bridge Mode. Bridge Mode is selected.
- Enable:** Radio buttons for Enable and Disable. Disable is selected.
- Encapsulation:** A dropdown menu showing "1483 Bridged IP LLC".

Figure 4-14

**Note:**

After you finish the Internet configuration, please click **SAVE** to make the settings take effect.

#### 4.3.1.3 IPv4/IPv6

If you select **IPv4/IPv6** as IP version, please follow both the [4.3.1.1 IPv4](#) and [4.3.1.2 IPv6](#) configuration based on different connection types to configure the parameters for WAN ports.

#### 4.3.2 LAN

Choose “**Interface Setup**→**LAN**” menu, and you will see the LAN screen (shown in Figure 4-15). Please configure the parameters for LAN ports according to the descriptions below.

| Interface   | Quick Start   | Interface Setup      | Advanced Setup | Access Management | Maintenance | Status | Help |          |            |             |        |             |  |               |                      |        |  |
|---|---|----------------------|----------------|-------------------|-------------|--------|------|----------|------------|-------------|--------|-------------|--|---------------|----------------------|--------|--|
|   | Internet  | LAN                  | Wireless       | 6RD               |             |        |      |          |            |             |        |             |  |               |                      |        |  |
| <b>Router Local IP</b>  | IP Address : 192.168.1.1<br>IP Subnet Mask : 255.255.255.0<br>Dynamic Route : RIP2-B    Direction : Both<br>Multicast : IGMP v2<br>IGMP Snoop : <input type="radio"/> Disabled <input checked="" type="radio"/> Enabled<br>MldSnoop : <input checked="" type="radio"/> Disabled <input type="radio"/> Enabled   |                      |                |                   |             |        |      |          |            |             |        |             |  |               |                      |        |  |
| <b>DHCP</b>   | DHCP : <input type="radio"/> Disabled <input checked="" type="radio"/> Enabled <input type="radio"/> Relay  |                      |                |                   |             |        |      |          |            |             |        |             |  |               |                      |        |  |
| <b>DHCP Server</b>  | Starting IP Address : 192.168.1.100 <input type="button" value="Current Pool Summary"/><br>IP Pool Count : 101<br>Lease Time : 259200 seconds (0 sets to default value of 259200)<br>Physical Ports : <input checked="" type="checkbox"/> 1 <input checked="" type="checkbox"/> 2 <input checked="" type="checkbox"/> 3 <input checked="" type="checkbox"/> 4 |                      |                |                   |             |        |      |          |            |             |        |             |  |               |                      |        |  |
| <b>DHCP Table</b>   | <table border="1"> <thead> <tr> <th>Hostname</th> <th>IP Address</th> <th>MAC Address</th> <th>Status</th> <th>Expire Time</th> </tr> </thead> <tbody> <tr> <td></td> <td>192.168.1.100</td> <td><input type="text"/></td> <td>Static</td> <td></td> </tr> </tbody> </table>  |                      |                |                   |             |        |      | Hostname | IP Address | MAC Address | Status | Expire Time |  | 192.168.1.100 | <input type="text"/> | Static |  |
| Hostname  | IP Address  | MAC Address          | Status         | Expire Time       |             |        |      |          |            |             |        |             |  |               |                      |        |  |
|   | 192.168.1.100   | <input type="text"/> | Static         |                   |             |        |      |          |            |             |        |             |  |               |                      |        |  |
| <b>DNS</b>  | DNS Relay : Use Auto Discovered DNS Server Only<br>Primary DNS Server : N/A<br>Secondary DNS Server : N/A   |                      |                |                   |             |        |      |          |            |             |        |             |  |               |                      |        |  |
| <b>Radvd</b>  | Radvd Enable : <input checked="" type="radio"/> Disable <input type="radio"/> Enable  |                      |                |                   |             |        |      |          |            |             |        |             |  |               |                      |        |  |
| <b>DHCPv6</b>   | DHCPv6 Server : <input checked="" type="radio"/> Disable <input type="radio"/> Enable   |                      |                |                   |             |        |      |          |            |             |        |             |  |               |                      |        |  |
| <input type="button" value="SAVE"/> <input type="button" value="CANCEL"/> |   |                      |                |                   |             |        |      |          |            |             |        |             |  |               |                      |        |  |

Figure 4-15

- **Router Local IP:** These are the IP settings of the LAN interface for the device. These settings may be referred to as Private settings. You may change the LAN IP address if needed. The LAN IP address is private to your internal network and cannot be seen on the Internet.
  - **IP Address:** Enter the modem router’s local IP Address, then you can access to the Web-based Utility via the IP Address, the default value is 192.168.1.1.
  - **IP Subnet Mask:** Enter the modem router’s Subnet Mask, the default value is 255.255.255.0.
  - **Dynamic Route:** Select this option to specify the RIP (Routing Information protocol) version for LAN interface, including **RIP1**, **RIP2-B** and **RIP2-M**. RIP2-B and RIP2-M are both sent in RIP2 format, the difference is that RIP2-M using Multicast, while RIP2-B using Broadcast format.

- **Direction:** Select this option to specify the RIP direction. **None** is for disabling the RIP function. **Both** means the ADSL modem router will periodically send routing information and accept routing information, and then incorporate them into routing table. **IN only** means the ADSL modem router will only accept but will not send RIP packet. **OUT only** means the ADSL modem router will only send but will not accept RIP packet.
  - **Multicast:** Select IGMP version, or disable the function. IGMP (Internet Group Multicast Protocol) is a session-layer protocol used to establish membership in a multicast group. The ADSL ATU-R supports both IGMP version 1 (**IGMP v1**), **IGMP v2** and **IGMP v3**. Select “Disabled” to disable it.
  - **IGMP Snoop:** Enable the IGMP Snoop function if you need.
  - **MldSnoop:** Enable the MldSnoop function if you need.
- **DHCP:** Select **Enabled**, then you will see the screen below (shown in Figure 4-16). The modem router will work as a DHCP Server; it becomes the default gateway for DHCP client connected to it. DHCP stands for Dynamic Host Control Protocol. The DHCP Server gives out IP addresses when a device is booting up and request an IP address to be logged on to the network. That device must be set as a DHCP client to obtain the IP address automatically. By default, the DHCP Server is enabled. The DHCP address pool contains the range of the IP address that will automatically be assigned to the clients on the network.

**DHCP**

DHCP :  Disabled  Enabled  Relay

**DHCP Server**

Starting IP Address : 192.168.1.100

IP Pool Count : 101

Lease Time : 259200 seconds (0 sets to default value of 259200)

Physical Ports :

|   |   |   |   |
|---|---|---|---|
| 1 | 2 | 3 | 4 |
|---|---|---|---|

**DHCP Table**

| Hostname | IP Address    | MAC Address          | Status | Expire Time |
|----------|---------------|----------------------|--------|-------------|
|          | 192.168.1.100 | <input type="text"/> | Static |             |

**DNS**

DNS Relay : Use Auto Discovered DNS Server Only

Primary DNS Server : N/A

Secondary DNS Server : N/A

**Radvd**

Radvd Enable :  Disable  Enable

**DHCPv6**

DHCPv6 Server :  Disable  Enable

Figure 4-16

- **Starting IP Address:** Enter the starting IP address for the DHCP server's IP assignment. The default Start IP Address is **192.168.1.100**.

- **Current Pool Summary:** Click the button, then you can view the IP addresses that the DHCP Server gives out.
- **IP Pool Count:** The max user pool size.
- **Lease Time:** The length of time for the IP lease. After the dynamic IP address has expired, the user will be automatically assigned a new dynamic IP address. The default is **259200** seconds.
- **Physical Ports:** If a physical port is unchecked, the client connected to that port will not be able to obtain IP address automatically although the DHCP function is enabled. All the ports are checked by default.

➤ **DHCP Table:** The information of the DHCP clients will be displayed here

| Hostname | IP Address      | MAC Address                             | Status   | Expire Time |
|----------|-----------------|---|----------|-------------|
|          | 192.168.1.101 ▾ | <input type="text"/><br>Manual Config ▾ | Static ▾ |             |
|          | 192.168.1.100   | 94:DE:80:B4:D0:51                       | Static   | N/A         |

- **Hostname:** Display the name of the DHCP client.
- **IP Address:** Display the IP Address of the DHCP client.
- **MAC Address:** Display the MAC Address of the DHCP client.
- **Status:** Display the status of the assigned IP Address, either **Static** or **Auto**. **Static** indicates that the IP Address is bounded to the MAC Address, while **Auto** indicates that the IP Address is assigned to the MAC Address automatically.

#### How to assign a static IP address to the client?

- 1) Select an **IP Address** from the drop-down list.
- 2) Enter the **MAC Address** of the client in the table.

➤ **DNS Relay:** If you want to disable this feature, you just need to set both Primary and secondary DNS IP to 0.0.0.0. If you want to use DNS relay, you can setup DNS server IP to 192.168.1.1 on their Computer. If not, the device will perform as no DNS relay.

- **Primary DNS Server:** Type in your preferred DNS server.
- **Secondary DNS Server:** Type in your preferred DNS server.

#### **Note:**

If **Use Auto Discovered DNS Server Only** is selected in DNS Relay, this modem router will accept the first received DNS assignment from one of the PPPoA, PPPoE or MER/DHCP enabled PVC(s) during the connection establishment. If **Use User Discovered DNS Server Only** is selected in DNS Relay, it is necessary for you to enter the primary and optional secondary DNS server IP addresses. After type in the address, click **SAVE** button to save it and invoke it.

- **Radvd:** Radvd (Router Advertisement Daemon) is provided to assign IPv6 addresses to the computers in your LAN. Enable this function if you need.
- **DHCPv6:** DHCPv6 is provided to assign IPv6 addresses to the computers in your LAN. Enable this function if you need.
- **DHCP Relay:** Select **Relay**, then you will see the next screen (shown in Figure 4-17), and the modem router will work as a DHCP Relay. A DHCP relay is a computer that forwards DHCP data between computers that request IP addresses and the DHCP server that assigns the addresses. Each of the device's interfaces can be configured as a DHCP relay. If it is enabled, the DHCP requests from local PCs will forward to the DHCP server runs on WAN side. To have this function working properly, please run on router mode only, disable the DHCP server on the LAN port, and make sure the routing table has the correct routing entry.

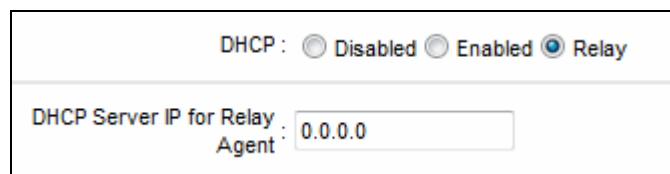

The screenshot shows a configuration window for DHCP. At the top, it says "DHCP :  Disabled  Enabled  Relay". Below this, there is a label "DHCP Server IP for Relay Agent" followed by a text input field containing the value "0.0.0.0".

Figure 4-17

- **DHCP Server IP for Relay Agent:** Enter the DHCP server IP Address runs on WAN side.

 **Note:**

If you select **Disabled**, the DHCP function will not take effect.

### 4.3.3 Wireless

Choose “**Interface Setup**→**Wireless**” menu, and you will see the Wireless screen (shown in Figure 4-18 ). Please configure the parameters for wireless according to the descriptions below.

| Interface   | Quick Start  | Interface Setup | Advanced Setup  | Access Management | Maintenance | Status | Help |
|---|--|-----------------|-----------------|-------------------|-------------|--------|------|
|   | Internet   | LAN             | <b>Wireless</b> | 6RD               |             |        |      |
| <b>Access Point Settings</b>  | Access Point : <input checked="" type="radio"/> Activated <input type="radio"/> Deactivated<br>Channel : UNITED STATES <input type="text"/> Auto <input type="text"/> Current Channel: <input type="text" value="1"/><br>Transmit Power : High <input type="text"/><br>Beacon Interval(ms) : <input type="text" value="100"/> (range: 20~1000)<br>RTS/CTS Threshold : <input type="text" value="2347"/> (range: 1500~2347)<br>Fragmentation Threshold(bytes) : <input type="text" value="2346"/> (range: 256~2346, even numbers only)<br>DTIM(ms) : <input type="text" value="1"/> (range: 1~255)<br>Wireless Mode : 802.11b+g+n <input type="text"/>  |                 |                 |                   |             |        |      |
| <b>11n Settings</b>   | Channel Bandwidth : Auto <input type="text"/><br>Extension Channel : above the control channel <input type="text"/><br>Guard Interval : AUTO <input type="text"/><br>MCS : AUTO <input type="text"/>   |                 |                 |                   |             |        |      |
| <b>Multiple SSIDs Settings</b>  | SSID Index : <input type="text" value="1"/><br>Broadcast SSID : <input checked="" type="radio"/> Yes <input type="radio"/> No<br>Use WPS : <input checked="" type="radio"/> Yes <input type="radio"/> No   |                 |                 |                   |             |        |      |
| <b>WPS Settings</b>   | WPS state : Configured<br>WPS mode : <input type="radio"/> PIN code <input checked="" type="radio"/> PBC<br><input type="button" value="Start WPS"/><br>WPS progress : Idle<br><input type="button" value="Reset to OOB"/><br>SSID : <input type="text" value="TP-LINK_EB6901"/><br>Authentication Type : WPA2-PSK <input type="text"/>  |                 |                 |                   |             |        |      |
| <b>WPA2-PSK</b>   | Encryption : AES <input type="text"/><br>Pre-Shared Key : <input type="text" value="54278417"/> (8~63 ASCII characters or 64 hexadecimal characters)   |                 |                 |                   |             |        |      |
| <b>WDS Settings</b>   | WDS Mode : <input type="radio"/> On <input checked="" type="radio"/> Off<br>WDS Encryption Type : TKIP <input type="text"/><br>WDS Key : <input type="text"/> (8~63 ASCII characters or 64 hexadecimal characters)<br>Mac Address #1 : <input type="text" value="00:00:00:00:00:00"/><br>Mac Address #2 : <input type="text" value="00:00:00:00:00:00"/><br>Mac Address #3 : <input type="text" value="00:00:00:00:00:00"/><br>Mac Address #4 : <input type="text" value="00:00:00:00:00:00"/>   |                 |                 |                   |             |        |      |
| <b>Wireless MAC Address Filter</b>  | Active : <input type="radio"/> Activated <input checked="" type="radio"/> Deactivated<br>Action : Allow Association <input type="text"/> the follow Wireless LAN station(s) association.<br>Mac Address #1 : <input type="text" value="00:00:00:00:00:00"/><br>Mac Address #2 : <input type="text" value="00:00:00:00:00:00"/><br>Mac Address #3 : <input type="text" value="00:00:00:00:00:00"/><br>Mac Address #4 : <input type="text" value="00:00:00:00:00:00"/><br>Mac Address #5 : <input type="text" value="00:00:00:00:00:00"/><br>Mac Address #6 : <input type="text" value="00:00:00:00:00:00"/><br>Mac Address #7 : <input type="text" value="00:00:00:00:00:00"/><br>Mac Address #8 : <input type="text" value="00:00:00:00:00:00"/> |                 |                 |                   |             |        |      |
| <input type="button" value="SAVE"/> <input type="button" value="CANCEL"/> |  |                 |                 |                   |             |        |      |

Figure 4-18

- **Access point Settings:** These are the settings of the access point. You can configure the rules to allow wireless-equipped computers and other devices to communicate with a wireless network.
- **Access point:** Select Activated to allow wireless station to associate with the access point.
  - **Channel:** Select your region and the channel you want to use from the drop-down List of Channel. This field determines which operating frequency will be used. It is not necessary to change the default channel unless you notice interference problems with another nearby access point.

 **Note:**

Per FCC regulations, all Wi-Fi products marketed in the U.S. must be fixed to the U.S. region only.

- **Transmit Power:** Here you can specify the transmit power of modem router. You can select High, Medium or Low which you would like. High is the default setting and is recommended.
- **Beacon Interval(ms):** Enter a value between 20-1000 milliseconds. The Beacon Interval value indicates the frequency interval of the beacon. A beacon is a packet broadcast by the modem router to synchronize the wireless network. The default value is 100.
- **RTS/CTS Threshold:** Should you encounter inconsistent data flow, only minor reduction of the default value 2347 is recommended. If a network packet is smaller than the preset RTS threshold size, the RTS/CTS mechanism will not be enabled. The modem router sends Request to Send (RTS) frames to a particular receiving station and negotiates the sending of a data frame. After receiving an RTS, the wireless station responds with a Clear to Send (CTS) frame to acknowledge the right to begin transmission. In most cases, keep its default value of 2347.
- **Fragmentation Threshold(bytes):** This value specifies the maximum size for a packet before data is fragmented into multiple packets. If you experience a high packet error rate, you may slightly increase the Fragmentation Threshold. Setting the Fragmentation Threshold too low may result in poor network performance. Only minor reduction of the default value is recommended. In most cases, it should remain at its default value of 2346.
- **DTIM(ms):** This value, between 1 and 255, indicates the interval of the Delivery Traffic Indication Message (DTIM). A DTIM field is a countdown field informing clients of the next window for listening to broadcast and multicast messages. When the modem router has buffered broadcast or multicast messages for associated clients, it sends the next DTIM with a DTIM Interval value. Its clients hear the beacons and awaken to receive the broadcast and multicast messages. The default value is 1.



- **Wireless Mode:** In the drop-down list you can select “802.11b”, “802.11g”, “802.11n”, “802.11b+g” and “802.11b+g+n”. “802.11b+g+n” allows 802.11b, 802.11g and 802.11n wireless stations to connect to the modem router.
- **11n Settings:** These are the settings of the 11n parameters. If “802.11n” or “802.11b+g+n” is selected for **Wireless mode**, these settings will be displayed.
- **Channel Bandwidth:** Select the Bandwidth you want to use from the drop-down List. There are three options: “20 MHz”, “Auto” and “40 MHz”. If bigger bandwidth is selected, device could transmit and receive data with higher speed. The default value is Auto.
  - **Extension Channel:** If “Auto” is selected, this option will be displayed.
  - **Guard Interval:** Select the guard interval you want from the drop-down list.
  - **MCS:** Select the wireless transmission rate from the drop-down list. By default, the option is AUTO.
- **Multiple SSIDs Settings:** These are the settings of the SSID.
- **SSID Index:** The index of the SSID. In this model, you can leave it as a default value of 1.
  - **Broadcast SSID:** When wireless clients survey the local area for wireless networks to associate with, they will detect the SSID broadcast by the modem router. To broadcast the modem router’s SSID, keep the default setting. If you don’t want to broadcast the modem router’s SSID, select “No”.
  - **Use WPS:** Use WPS (Wi-Fi Protected Setup) function, you can add a new wireless device to an existing network quickly. To Use WPS, keep the default setting, and configure the parameters in **WPS Settings**. If you don’t want to Use WPS, select “No”, then you will see the screen as shown below.

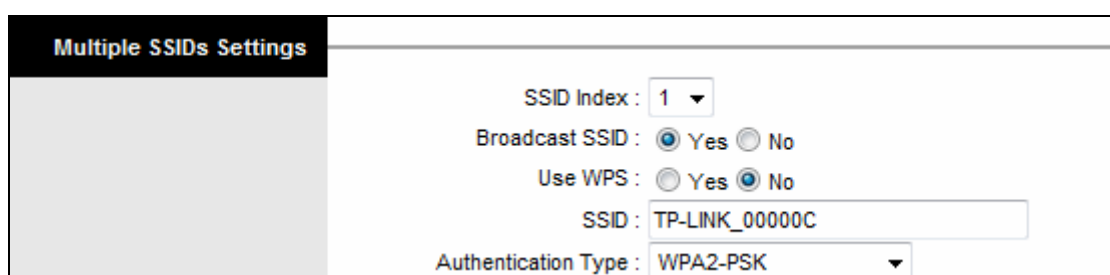

Figure 4-19

- **SSID:** Wireless network name shared among all points in a wireless network. The SSID must be identical for all devices in the wireless network. It is case-sensitive and must not exceed 32 characters (use any of the characters on the keyboard). Make sure this setting is the same for all stations in your wireless network. Type the desired SSID in the space provided.
- **Authentication Type:** Select an authentication type from the drop-down list, which allows you to configure security features of the wireless LAN interface. Options available

are: Disabled, WEP-64Bits, WEP-128Bits, WPA-PSK, WPA2-PSK, and WPA-PSK/WPA2-PSK. The default Authentication Type is WPA2-PSK.

**1) WEP-64Bits**

To configure WEP-64Bits settings, select the WEP-64Bits option from the drop-down list. The menu will change to offer the appropriate settings. WEP-64Bits is a data privacy mechanism based on a 64-bit shared key algorithm, as described in the IEEE 802.11g standard.

The screenshot shows the 'Multiple SSIDs Settings' and 'WEP' sections. In the 'Multiple SSIDs Settings' section, 'SSID Index' is 1, 'Broadcast SSID' is Yes, 'Use WPS' is No, and 'SSID' is TP-LINK\_00000C. The 'Authentication Type' is set to WEP-64Bits. In the 'WEP' section, instructions for key lengths are provided. Four key input fields are shown, all with the value 0x0000000000.

Figure 4-20

**2) WEP-128Bits**

To configure WEP-128Bits settings, select the WEP-128Bits option from the drop-down list. The menu will change to offer the appropriate settings. 128-bit is stronger than 64-bit.

The screenshot shows the 'Multiple SSIDs Settings' and 'WEP' sections. In the 'Multiple SSIDs Settings' section, 'SSID Index' is 1, 'Broadcast SSID' is Yes, 'Use WPS' is No, and 'SSID' is TP-LINK\_00000C. The 'Authentication Type' is set to WEP-128Bits. In the 'WEP' section, instructions for key lengths are provided. Four key input fields are shown, all with the value 0x00000000000000000000000000000000.

Figure 4-21

**3) WPA-PSK**

To configure WPA-PSK settings, select the WPA-PSK option from the drop-down list. The menu will change to offer the appropriate settings. WPA-PSK requires a shared key and does not use a separate server for authentication. PSK keys can be ASCII or Hex type.

| Multiple SSIDs Settings |   |
|-------------------------|---|
|                         | SSID Index : 1<br>Broadcast SSID : <input checked="" type="radio"/> Yes <input type="radio"/> No<br>Use WPS : <input type="radio"/> Yes <input checked="" type="radio"/> No<br>SSID : TP-LINK_00000C<br>Authentication Type : WPA-PSK |
| WPA-PSK                 |   |
|                         | Encryption : AES<br>Pre-Shared Key : 12345670 (8-63 ASCII characters or 64 hexadecimal characters)  |

Figure 4-22

- **Encryption:** Select the encryption you want to use: TKIP/AES, TKIP or AES (AES is an encryption method stronger than TKIP).
  - **TKIP (Temporal Key Integrity Protocol)** - a wireless encryption protocol that provides dynamic encryption keys for each packet transmitted.
  - **AES (Advanced Encryption Standard)** - A security method that uses symmetric 128-bit block data encryption.
- **Pre-Shared Key:** Enter the key shared by the modem router and your other network devices. It must have 8-63 ASCII characters or 64 Hexadecimal digits.

#### 4) WPA2-PSK

To configure WPA2-PSK settings, select the WPA2-PSK option from the drop-down list. The menu will change to offer the appropriate settings. WPA2-PSK requires a shared key and does not use a separate server for authentication. PSK keys can be ASCII or Hex type.

| Multiple SSIDs Settings |  |
|-------------------------|--|
|                         | SSID Index : 1<br>Broadcast SSID : <input checked="" type="radio"/> Yes <input type="radio"/> No<br>Use WPS : <input type="radio"/> Yes <input checked="" type="radio"/> No<br>SSID : TP-LINK_00000C<br>Authentication Type : WPA2-PSK |
| WPA2-PSK                |  |
|                         | Encryption : AES<br>Pre-Shared Key : 12345670 (8-63 ASCII characters or 64 hexadecimal characters)   |

Figure 4-23

#### 5) WPA-PSK/WPA2-PSK

To configure WPA-PSK/WPA2-PSK settings, select the WPA-PSK/WPA2-PSK option from the drop-down list. The menu will change to offer the appropriate settings. WPA-PSK/WPA2-PSK requires a shared key and does not use a separate server for authentication. PSK keys can be ASCII or Hex type. WPA-PSK/WPA2-PSK is more flexible than WPA-PSK or WPA2-PSK.

|                                |  |
|--------------------------------|--|
| <b>Multiple SSIDs Settings</b> | SSID Index : 1<br>Broadcast SSID : <input checked="" type="radio"/> Yes <input type="radio"/> No<br>Use WPS : <input type="radio"/> Yes <input checked="" type="radio"/> No<br>SSID : TP-LINK_00000C<br>Authentication Type : WPA-PSK/WPA2-PSK |
| <b>WPA-PSK/WPA2-PSK</b>        | Encryption : AES<br>Pre-Shared Key : 12345670 (8-63 ASCII characters or 64 hexadecimal characters)   |

Figure 4-24

### WPS Settings

This section will guide you to add a new wireless device to an existing network quickly by WPS (or called QSS) method.

**Note:**

- 1) This feature is available only when OPEN, WPA-PSK, WPA2-PSK or Mixed WPA2/WPA-PSK mode is configured.
- 2) To build a successful connection by WPS, you should also do the corresponding configuration of the new device for WPS function meanwhile.

#### 1) By PBC

There are two ways to add the wireless adapter to the network by PBC.

**Method One:** Hardware push button.

**Step 1:** Press the WPS/RESET button on the back panel of the modem router

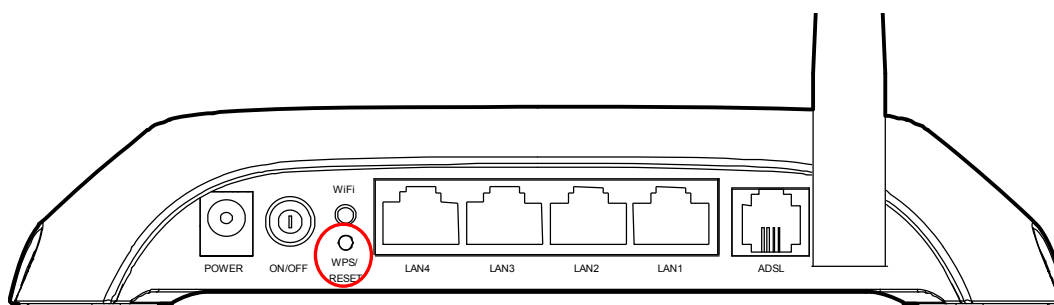

Figure 4-25

**Step 2:** Press and hold the WPS button of the adapter directly for 2 or 3 seconds.



**Step 3:** Wait for a while until the next screen appears. Click **Finish** to complete the WPS configuration.



The WPS Configuration Screen of Wireless Adapter

**Method Two:** Software push button.

**Step 1:** Click **Start WPS** button in Figure 4-26.

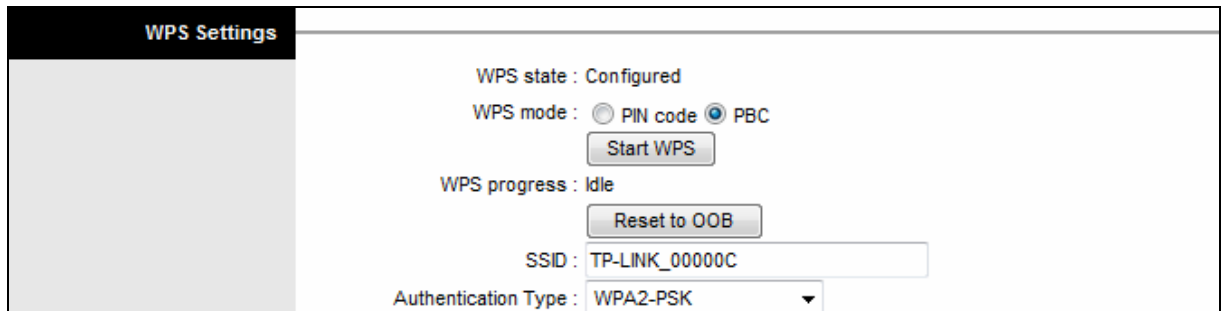

Figure 4-26

**Step 2:** For the configuration of the wireless adapter, please choose “**Push the button on my access point**” in the configuration utility of the WPS as below, and click **Next**.



The WPS Configuration Screen of Wireless Adapter

**Step 3:** Wait for a while until the next screen appears. Click **Finish** to complete the WPS configuration.

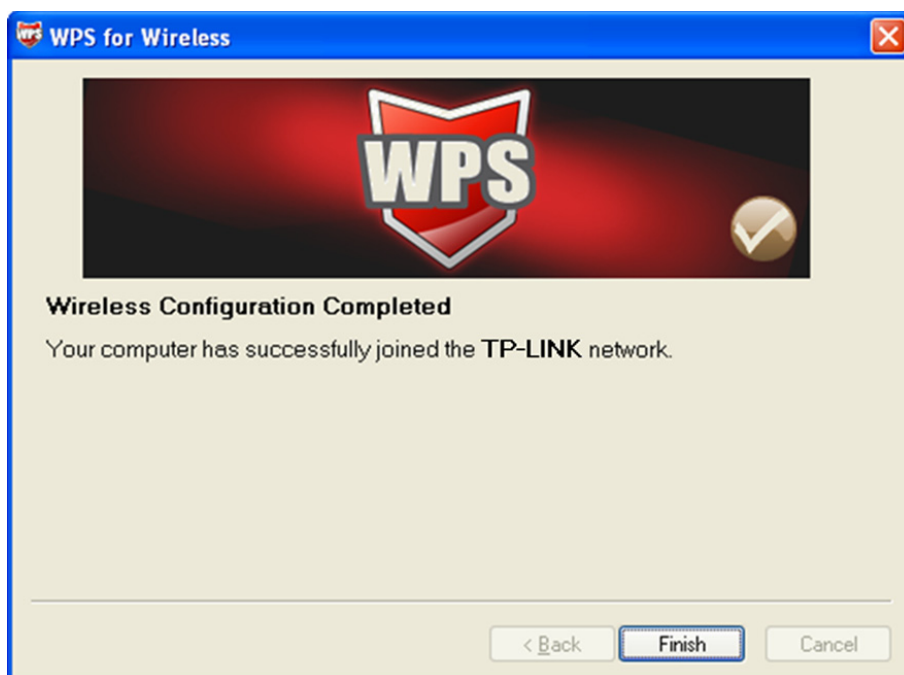

The WPS Configuration Screen of Wireless Adapter

## 2) By PIN

If the new device supports Quick Security Setup and the PIN method, you can add it to the network by PIN with the following two methods.

**Method One:** Enter the PIN into my modem router.

**Step 1:** Keep **PIN code** selected and enter the PIN code of the wireless adapter in the field after **enrollee PIN code** as shown below. Then click **Start WPS**.

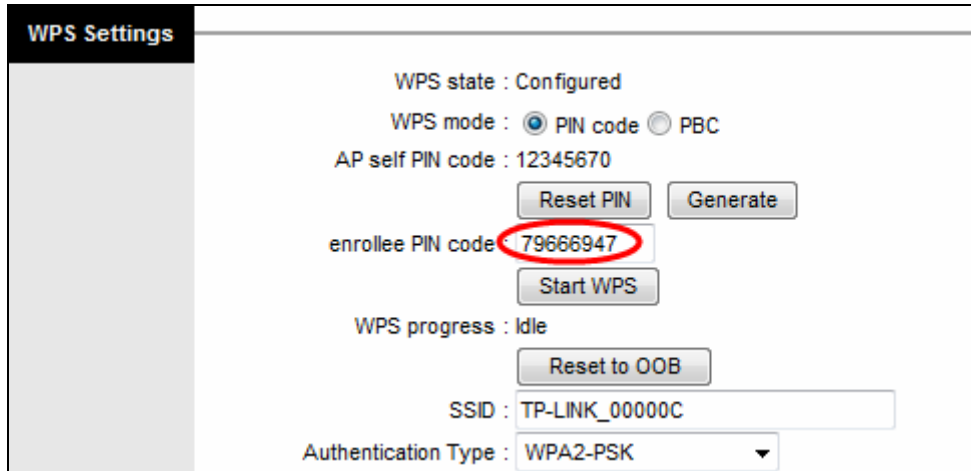

Figure 4-27

**Note:**

The PIN code of the adapter is always displayed on the WPS configuration screen.

**Step 2:** For the configuration of the wireless adapter, please choose “**Enter a PIN into my access point or a registrar**” in the configuration utility of the WPS, and get the PIN code on the screen as below, then click **Next**.



The WPS Configuration Screen of Wireless Adapter

**Note:**

In this example, the default PIN code of this adapter is 79666947 as the preceding figure shown.

**Method Two:** Enter the PIN of my modem router into the wireless adapter.

**Step 1:** Get the Current PIN code of the modem router from **AP self PIN code**. Each modem router has its unique PIN code. Here takes the PIN code 12345670 of this modem router for example.

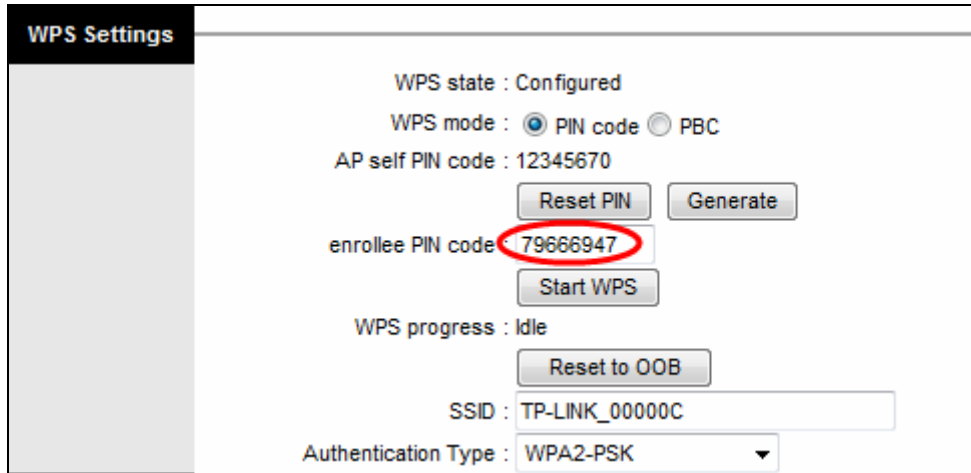

**Step 2:** For the configuration of the wireless adapter, please choose “**Enter a PIN from my access point**” in the configuration utility of the WPS as below, and enter the PIN code of the modem router into the field after “**Access Point PIN**”. Then click **Next**.

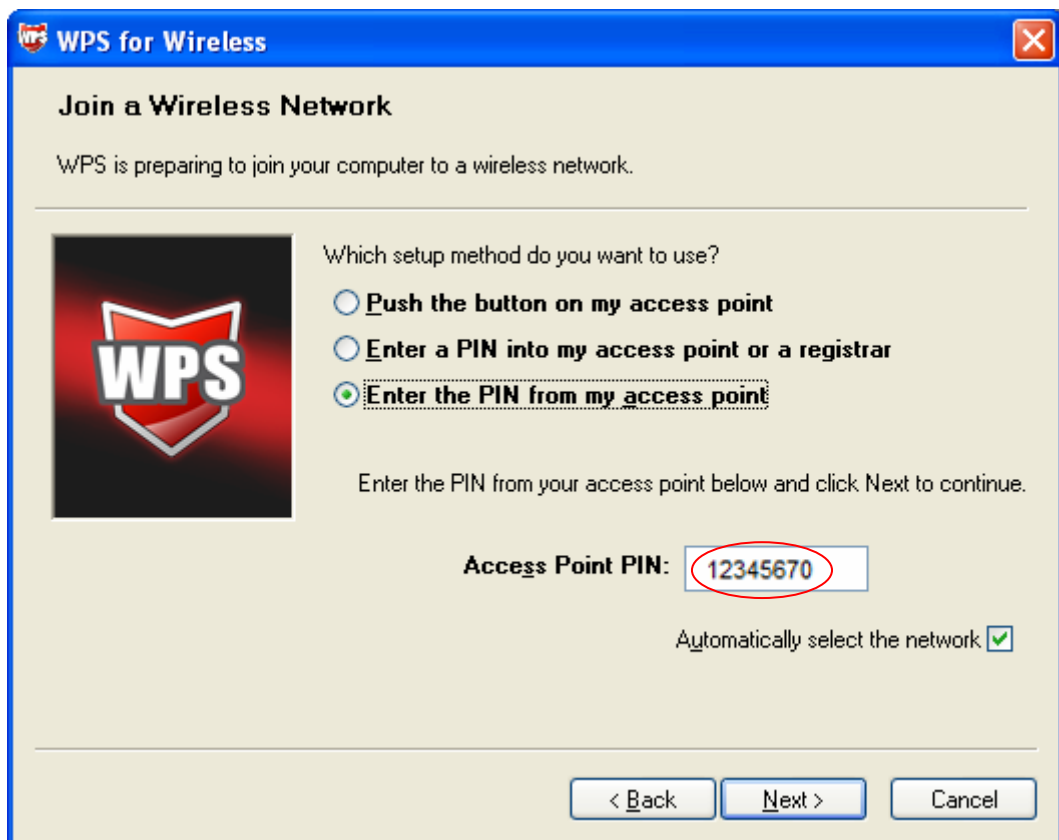

The WPS Configuration Screen of Wireless Adapter



- **SSID:** Wireless network name shared among all points in a wireless network. The SSID must be identical for all devices in the wireless network. It is case-sensitive and must not exceed 32 characters (use any of the characters on the keyboard). Make sure this setting is the same for all stations in your wireless network. Type the desired SSID in the space provided.
  - **Authentication Type:** Select an authentication type from the drop-down list, which allows you to configure security features of the wireless LAN interface. Options available are: Disabled, WEP-64Bits, WEP-128Bits, WPA-PSK, WPA2-PSK, and WPA-PSK/WPA2-PSK.
- **WDS Settings:** Select On/Off to enable/disable WDS. With this function enabled, the modem router can bridge two or more WLANs.
- **MAC Address:** Enter the MAC Address you wish to bridge in the field.
- **Wireless MAC Address Filter:** Wireless access can be filtered by using the MAC addresses of the wireless devices transmitting within your network's RADIUS.
- **Active:** If you wish to filter users by MAC Address, select "Activated", and "Deactivated" for don't.
  - **Action:** To filter wireless users by MAC Address, select "Allow Association" or "Deny Association" the follow Wireless LAN station(s) association.
  - **MAC Address:** Enter the MAC Address you wish to filter in the field.

 **Note:**

For most users, it is recommended to use the default Wireless LAN Performance settings. Any changes made to these settings may adversely affect your wireless network. Under certain circumstances, changes may benefit performance. Carefully consider and evaluate any changes to these wireless settings.

#### 4.3.4 6RD

IPv6 tunnel is a kind of transition mechanism to enable IPv6-only hosts to reach IPv4 services and to allow isolated IPv6 hosts and networks to reach each-other over IPv4-only infrastructure before IPv6 completely supplants IPv4. It is a temporary solution for networks that do not support native dual-stack, where both IPv6 and IPv4 run independently.

As a type of IPv6 tunnel, 6RD is used in the situation that your WAN connection is IPv4 while LAN connection is IPv6. Choose "**Interface Setup**→**Wireless**" menu, and you will see the screen as shown in Figure 4-28.

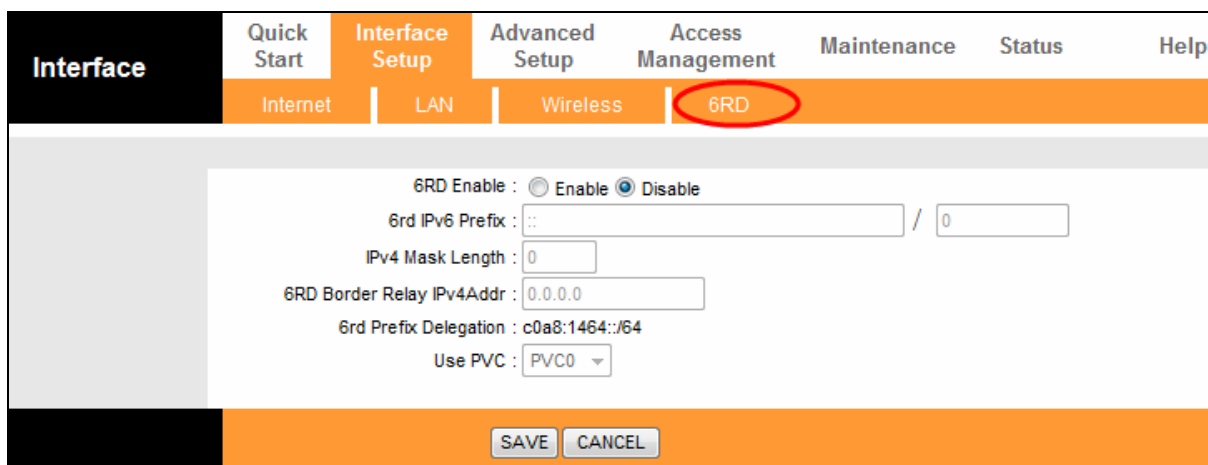

Figure 4-28

- **6rd IPv6 Prefix:** The prefix of the 6RD tunnel.
- **IPv4 Mask Length:** The length of the IPv4 mask.
- **6RD Border Relay IPv4 Address:** The IPv4 address of the border relay router of 6RD tunnel.
- **Use PVC:** Select the PVC from the the drop-down list.

 **Note:**

To enable the function, there should not have any IPv6 WAN connections.

### 4.3.5 Guest Network

Go to “**Interface Setup**→**Guest Network**”, and you will see the Guest Network screen. This feature allows you to create a separate network for your guests without allowing them to access your main network and the computers connected to it.

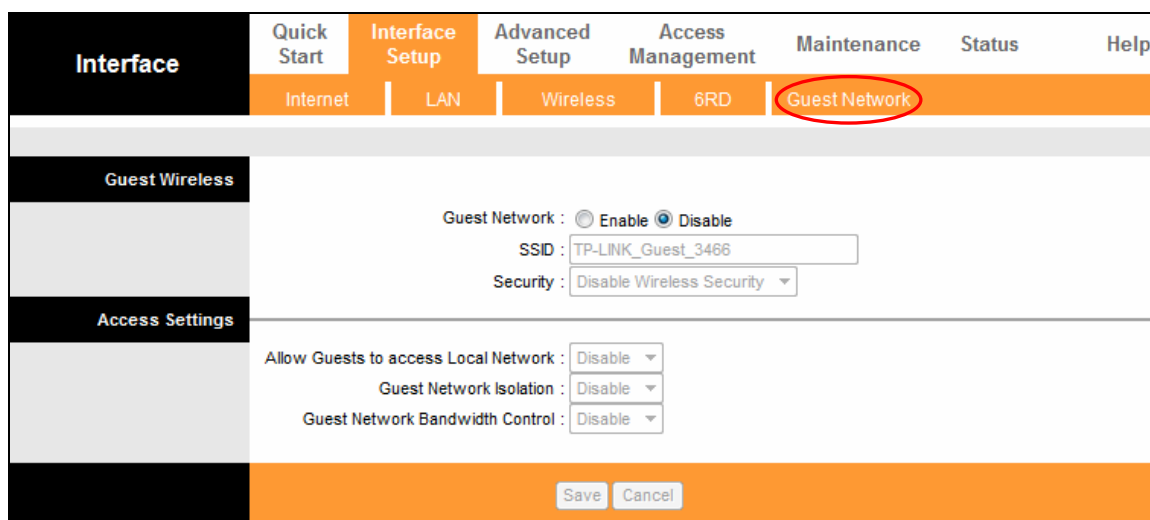

You can enable or disable Guest Network. The default setting is disabled. When you enable this function, you could set wireless parameters for Guest Network.

|   |
|---|
| Guest Network : <input checked="" type="radio"/> Enable <input type="radio"/> Disable<br>SSID : <input type="text" value="TP-LINK_Guest_3466"/><br>Security : <input type="text" value="WPA/WPA2 - Persionnal"/><br>Authentication Type : <input type="text" value="Auto"/><br>Encryption : <input type="text" value="AES"/><br>Wireless Password : <input type="text" value="123456789"/><br>(Enter ASCII characters between 8 and 63 or Hexadecimal characters between 8 and 64.)<br>Group Key Update Period : <input type="text" value="0"/> (seconds, minimum is 30. 0 means no update) |
| Allow Guests to access Local Network : <input type="text" value="Disable"/><br>Guest Network Isolation : <input type="text" value="Disable"/><br>Guest Network Bandwidth Control : <input type="text" value="Disable"/>   |

- **Guest SSID:** The guest network name. When setting up a Guest network, it is strongly recommended to use a name that easily distinguishes it from your primary network.
- **Authentication Type:** Select the Authentication Type from the drop-down list.
- **Encryption:** You can select either **AUTO**, **AES** or **TKIP**.
- **Wireless Password:** You may personalize your guest network password by entering a new password.
- **Group Key Update Period:** Specify the group key update interval in seconds. The value should be 30 or above. Enter 0 to disable the update.
- **Allow Guests to access Local Network:** The guests have access to your local Network, but cannot login the modem router's web management interface.
- **Guest Network Isolation:** This function can isolate wireless clients on your guest network from each other. Client isolation is disabled by default.
- **Guest Network Bandwidth Control:** With this function, you can configure the Upstream Bandwidth and Downstream Bandwidth for guest network.

Click **Save** to save your settings.

## 4.4 Advanced Setup

Choose "**Advanced Setup**", you can see the next submenus:

|             |                 |                       |                   |             |        |      |
|-------------|-----------------|-----------------------|-------------------|-------------|--------|------|
| Quick Start | Interface Setup | <b>Advanced Setup</b> | Access Management | Maintenance | Status | Help |
| Firewall    | Routing         | NAT                   | QoS               | VLAN        | ADSL   |      |

Figure 4-29

Click any of them, and you will be able to configure the corresponding function.

### 4.4.1 Firewall

Choose “Advanced Setup→Firewall” menu, and you will see the next screen (shown in Figure 4-30).

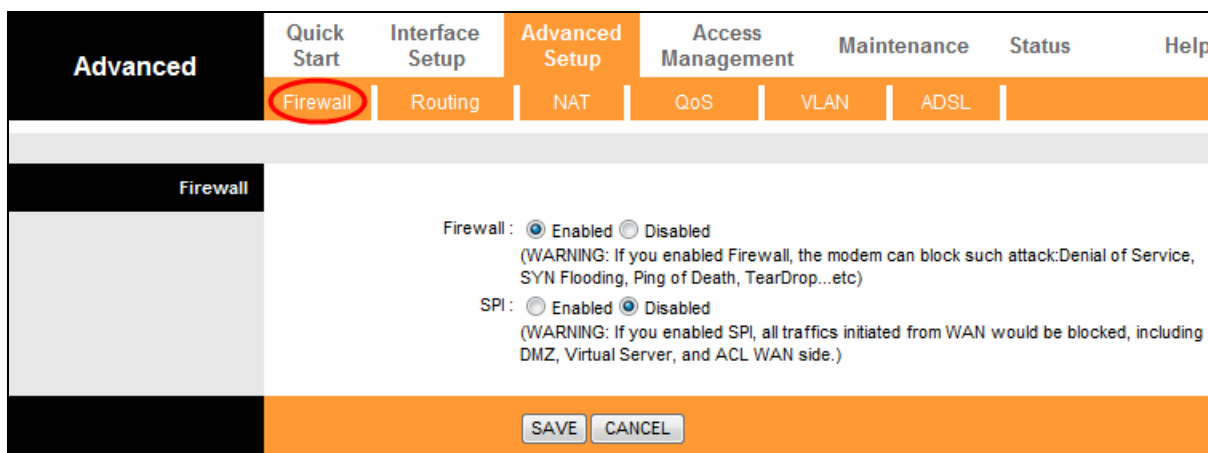

Figure 4-30

- **Firewall:** Select this option can automatically detect and block Denial of Service (DoS) attacks, such as Ping of Death, SYN Flood, Port Scan and Land Attack.
- **SPI:** If you enable SPI, all traffics initiated from WAN would be blocked, including DMZ, Virtual Server, and ACL WAN side.

### 4.4.2 Routing

Choose “Advanced Setup→Routing” menu, and you will see the routing information in the next screen (shown in Figure 4-31).

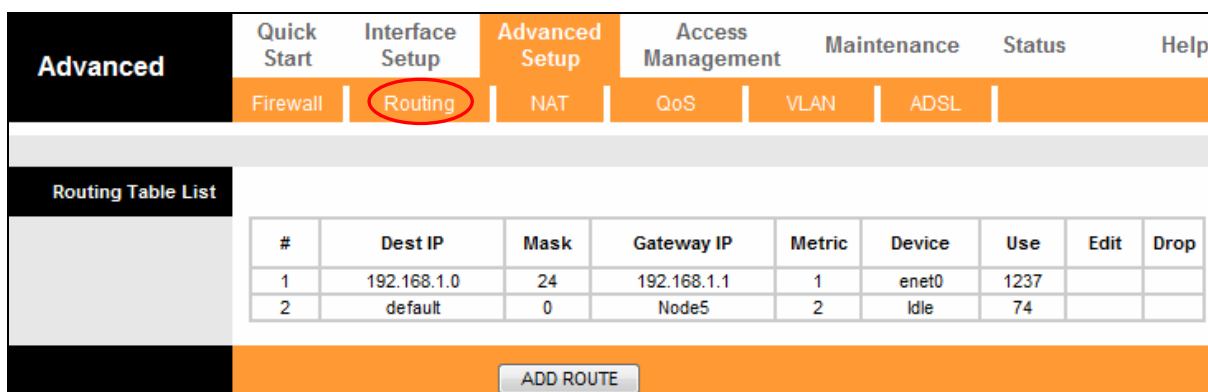

Figure 4-31

Click **ADD ROUTE** button to add a new route in the next screen (shown in Figure 4-32).

Static Route

Destination IP Address : 0.0.0.0

IP Subnet Mask : 0.0.0.0

Gateway IP Address :  0.0.0.0  PVC0

Metric : 0

Announced in RIP : Yes

SAVE DELETE BACK CANCEL

Figure 4-32

- **Destination IP Address:** This parameter specifies the IP network address of the final destination.
- **IP Subnet Mask:** Enter the subnet mask for this destination.
- **Gateway IP Address:** Enter the IP address of the gateway. The gateway is an immediate neighbor of your ADSL modem router that will forward the packet to the destination. On the LAN, the gateway must be a router on the same segment as your Router; over Internet (WAN), the gateway must be the IP address of one of the remote nodes.
- **Metric:** Metric represents the "cost" of transmission for routing purposes. IP Routing uses hop count as the measurement of cost, with a minimum of 1 for directly connected networks. Enter a number that approximates the cost for this link. The number need not to be precise, but it must between 1 and 15. In practice, 2 or 3 is usually a good number.
- **Announced in RIP:** This parameter determines if the ADSL router will include the route to this remote node in its RIP broadcasts. If set to Yes, the route to this remote node will be propagated to other hosts through RIP broadcasts. If No, this route is kept private and is not included in RIP broadcasts.

#### 4.4.3 NAT

Choose “**Advanced Setup**→**NAT**” menu, you can set up the NAT (Network Address Translation) function for the modem router (shown in Figure 4-33).

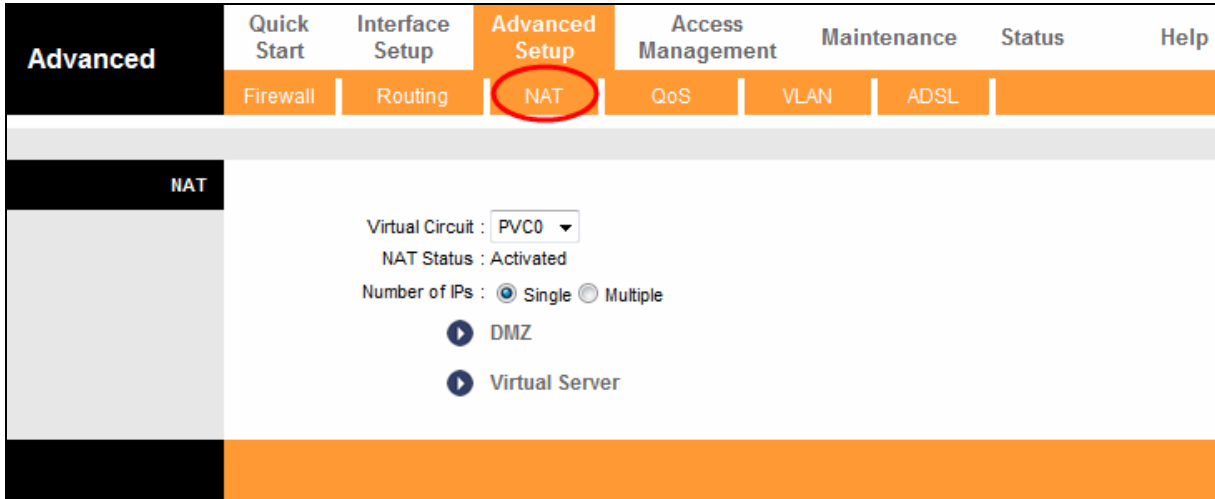

Figure 4-33

- **Virtual Circuit:** Enter Virtual Circuit Index that you plan to setup for the NAT function.
- **NAT Status:** This field shows the current status of the NAT function for the current VC. You can go to the previous screen (shown in Figure 4-6) to activate the function.
- **Number of IPs:** This field is to specify how many IPs are provided by your ISP for current VC. It can be single IP or multiple IPs. We select Multiple to explain.

**Note:**

For VCs with single IP, they share the same DMZ and Virtual servers; for VCs with multiple IPs, each VC can set DMZ and Virtual servers. Furthermore, for VCs with multiple IPs, they can define the Address Mapping rules; for VCs with single IP, since they have only one IP, there is no need to individually define the Address Mapping rule.

**4.4.3.1 DMZ**

Choose “**Advanced Setup**→**NAT**→**DMZ**” in Figure 4-33, you can configure the DMZ host in the next screen. A DMZ (demilitarized zone) is a host between a private local network and the outside public network. It prevents outside users from getting direct access to a server that has company data. Users of the public network outside the company can access to the DMZ host.

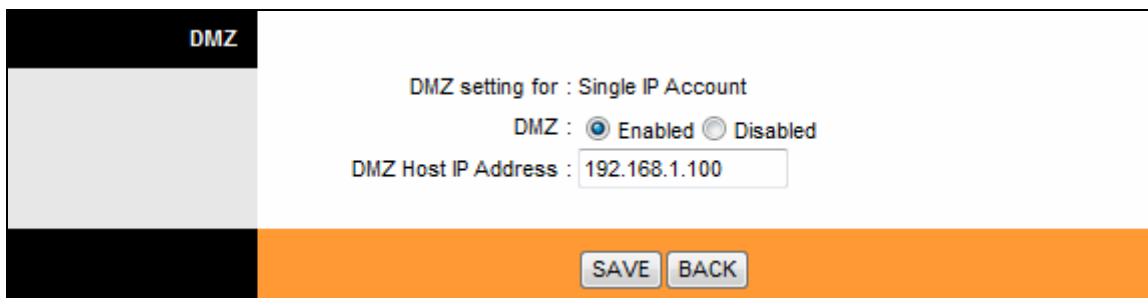

Figure 4-34

- **DMZ Host IP Address:** Enter the specified IP Address for DMZ host on the LAN side.

#### 4.4.3.2 Virtual Server

Choose “**Advanced Setup**→**NAT**→**Virtual Server**” in Figure 4-33, you can configure the Virtual Server in the next screen.

The Virtual Server is the server or server(s) behind NAT (on the LAN), for example, Web server or FTP server, that you can make visible to the outside world even though NAT makes your whole inside network appear as a single machine to the outside world.

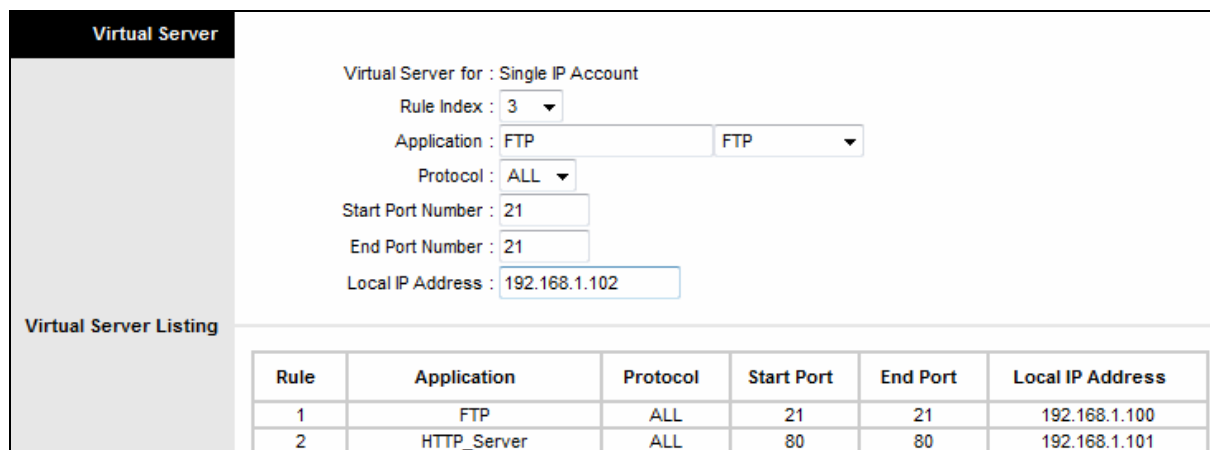

Virtual Server for : Single IP Account

Rule Index : 3

Application : FTP FTP

Protocol : ALL

Start Port Number : 21

End Port Number : 21

Local IP Address : 192.168.1.102

| Rule | Application | Protocol | Start Port | End Port | Local IP Address |
|------|-------------|----------|------------|----------|------------------|
| 1    | FTP         | ALL      | 21         | 21       | 192.168.1.100    |
| 2    | HTTP_Server | ALL      | 80         | 80       | 192.168.1.101    |

Figure 4-35

- **Rule Index:** The Virtual server rule index for this VC. You can specify 12 rules in maximum. All the VCs with single IP will use the same Virtual Server rules.
- **Application:** The Virtual servers can be used for setting up public services on your LAN.
- **Protocol:** The protocol used for this application.
- **Start & End port number:** Enter the specific Start and End Port number you want to forward. If it is one port only, you can enter the End port number the same as Start port number. For example, if you want to set the FTP Virtual server, you can set the start and end port number to 21.
- **Local IP Address:** Enter the IP Address for the Virtual Server in LAN side.
- **Virtual Server Listing:** This displays the information about the Virtual Servers you establish.

#### To add a virtual server entry:

**Step 1:** Select the “Virtual Circuit” and select “Virtual Server”.

 **Note:**

For VCs with single IP, select **Single**; For VCs with multiple IPs, select **Multiple** for the option.

**Step 2:** Select the Rule index for the rule as shown in Figure 4-35.

**Step 3:** Select the application you want from drop-down list, then the protocol and port number will be added to the corresponding field automatically, you only need to configure the IP address for the virtual server; If the application list does not contain the service that you want, please configure the Port number, IP Address and Protocol manually.

**Step 4:** After that, click **SAVE** to make the entry take effect.

**Other operations for the entries as shown in Figure 4-35:**

Enter the index of assigned entry, and click the **DELETE** button to delete the entry.

Click the **BACK** button to return to the previous screen.

Click the **CANCEL** button to cancel the configuration which is made just now.

**4.4.3.3 IP Address Mapping**

Select **Multiple** for **numbers of IPs** in Figure 4-33, and choose “**Advanced Setup→NAT→IP Address Mapping(for Multiple IP Service)**”. You can configure the Address Mapping Rule in the next screen. The IP Address Mapping is for those VCs that configured with multiple IPs. The IP Address Mapping rule is per-VC based (only for Multiple IPs' VCs).

| Rule | Type | Local Start IP | Local End IP    | Public Start IP | Public End IP |
|------|------|----------------|-----------------|-----------------|---------------|
| 1    | M-1  | 0.0.0.0        | 255.255.255.255 | 0.0.0.0         | ...           |

Figure 4-36

- **Rule Index:** Select the Virtual server rule index for this VC. You can specify 8 rules in maximum.
- **Rule Type:** There are four types: one-to-one, Many-to-One, Many-to-Many Overload and Many-to-Many No-overload.
- **Local Start & End IP:** Enter the local IP Address you plan to map to. Local Start IP is the starting local IP address and Local End IP is the ending local IP address. If the rule is for all local IPs, then the Start IP is 0.0.0.0 and the End IP is 255.255.255.255.
- **Public Start & End IP:** Enter the public IP Address you want to do NAT. Public Start IP is the starting public IP address and Public End IP is the ending public IP address. If you have a dynamic IP, enter 0.0.0.0 as the Public Start IP.
- **Address Mapping List:** This displays the information about the Mapping addresses.



To add a mapping rule:

**Step 1:** Select the “Virtual Circuit” and Multiple for the “Number of IPs”. Then select the tab **IP Address Mapping** (shown in Figure 4-33).

 **Note:**

**IP Address Mapping** is only available for VCs with Multiple IPs.

**Step 2:** Select the Rule index for the rule as shown in Figure 4-36.

**Step 3:** Select the rule type you want from the drop-down list.

**Step 4:** Enter the local and public IP addresses in the corresponding fields.

**Step 5:** After that, click **SAVE** to make the entry take effect.

**Other operations for the entries as shown in Figure 4-36:**

Select the index of assigned entry, and click the **DELETE** button to delete the entry.

Click the **BACK** button to return to the previous screen.

Click the **CANCEL** button to cancel the configuration which is made just now.

#### 4.4.4 QoS

Choose “**Advanced Setup**→**QoS**”, you can configure the QoS in the next screen. QoS helps to prioritize data as it enters your modem router. By attaching special identification marks or headers to incoming packets, QoS determines which queue the packets enter, based on priority. This is useful when you want to give certain types of data higher priority, such as giving voice data packets higher priority than Web data packets. This option will provide better service of selected network traffic over various technologies.

Figure 4-37

- **IP Version:** Select your IP version.
- **QoS:** Select this option to Activate/Deactivate the IP QoS on different types (IP ToS and DiffServ).
- **Summary:** Click the button to view the configurations of QoS.
- **Rule:** Configure the rules for QoS. If the traffic complies with the rule, then the modem router will take the corresponding action to deal with it.
  - **Rule Index:** Select the index for the rule you want to configure.
  - **Active:** Activate the rule. The rule can take effect only when it is activated.

- **Application:** Select the application that the rule aimed at.
- **Physical Ports:** Select the port whose traffic flow are controlled by the rule.
- **Destination MAC & IP & Mask & Port Range:** Enter the IP information about the Destination host for the rule.
- **Source MAC & IP & Mask & Port Range:** Enter the IP information about the Source host for the rule.
- **Protocol ID:** Select one among TCP/UDP, TCP, UDP or ICMP protocols for the application.
- **Vlan ID Range:** Enter the Vlan range, and the rule will be effective to the selected Vlans.
- **IPP/DS Field:** Select the type of the action to assign the priority.

When you select IPP/TOS, you can assign the priority via IP information. IP QoS function is intended to deliver guaranteed as well as differentiated Internet services by giving network resource and usage control to the Network operator.

- **IP Precedence Range:** Enter the IP precedence range that the modem router takes to differentiate the traffic.
- **Type of Service:** Select the type of service that the modem router takes to deal with the traffic.
- **802.1p:** Select the priority range for the rule.

When you select DSCP, you can assign the priority via DHCP (the header of IP group). It maps the IP group into corresponding service class.

- **DSCP Range:** Enter the DSCP range to differentiate the traffic.
  - **802.1p:** Select the priority range for the rule.
- **Action:** Configure the action that the modem router takes to deal with the traffic which accord with the rule.
- **IPP/DS Field:** Select the type for the action.
  - **IP Precedence Remarking:** Select the number to remark the priority for IP precedence.
  - **Type of Service Remarking:** Select the type to remark the service.
  - **DSCP Remarking:** Enter the number to remark the DSCP priority.
  - **802.1p Remarking:** Select the type to remark the 802.1p priority.
  - **Queue:** Select the priority type for the action.

#### 4.4.5 VLAN

Choose “**Advanced Setup**→**VLAN**”, you can activate the VLAN function in the next screen.

Virtual LAN (VLAN) is a group of devices on one or more LANs that are configured so that they can communicate as if they were attached to the same LAN. Because VLANs are based on logical instead of physical connections, it is very flexible for user/host management, bandwidth allocation and resource optimization. There are two types of VLAN as follows:

**Port-Based VLAN:** Each physical switch port is configured with an access list specifying membership in a set of VLANs.

**ATM VLAN:** Using LAN Emulation (LANE) protocol to map Ethernet packets into ATM cells and deliver them to their destination by converting an Ethernet MAC address into an ATM address.

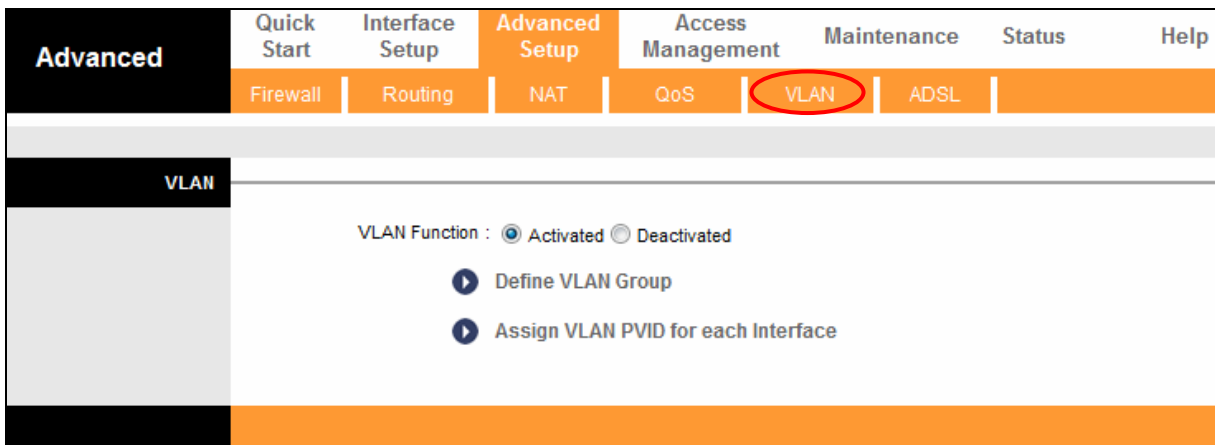

Figure 4-38

##### 1) Define VLAN Group

Click **Define VLAN Group** in Figure 4-38, you can define VLAN groups in the next screen (shown in Figure 4-39).

VLAN Group Setting

VLAN Index :

Active :  Yes  No

VLAN ID :  (Decimal)

ATM VCs :

|        |                                     |                                     |                                     |                                     |                                     |                                     |                                     |
|--------|-------------------------------------|-------------------------------------|-------------------------------------|-------------------------------------|-------------------------------------|-------------------------------------|-------------------------------------|
| Tagged | <input type="checkbox"/>            | <input type="checkbox"/>            | <input type="checkbox"/>            | <input type="checkbox"/>            | <input type="checkbox"/>            | <input type="checkbox"/>            | <input type="checkbox"/>            |
| Port # | <input checked="" type="checkbox"/> | <input checked="" type="checkbox"/> | <input checked="" type="checkbox"/> | <input checked="" type="checkbox"/> | <input checked="" type="checkbox"/> | <input checked="" type="checkbox"/> | <input checked="" type="checkbox"/> |
|        | 0                                   | 1                                   | 2                                   | 3                                   | 4                                   | 5                                   | 6                                   |

Ethernet :

|        |                                     |                                     |                                     |                                     |
|--------|-------------------------------------|-------------------------------------|-------------------------------------|-------------------------------------|
| Tagged | <input type="checkbox"/>            | <input type="checkbox"/>            | <input type="checkbox"/>            | <input type="checkbox"/>            |
| Port # | <input checked="" type="checkbox"/> | <input checked="" type="checkbox"/> | <input checked="" type="checkbox"/> | <input checked="" type="checkbox"/> |
|        | 1                                   | 2                                   | 3                                   | 4                                   |

Wireless LAN :

|        |                                     |
|--------|-------------------------------------|
| Tagged | <input type="checkbox"/>            |
| Port # | <input checked="" type="checkbox"/> |
|        | 1                                   |

VLAN Group Summary

| Group | Active | ID | VLAN Group Ports                       | VLAN Tagged Ports |
|-------|--------|----|--|-------------------|
| 1     | Yes    | 1  | e4,e3,e2,e1,w1,p0,p1,p2,p3,p4,p5,p6,p7 |                   |

p:pvc, e:ethernet, and w:wlan

Figure 4-39

- **VLAN Index:** Select the VLAN index for this VC. You can specify 8 groups in maximum.
- **VLAN ID:** This indicates the VLAN group.
- **ATM VCs:** Select the ATM VCs as members of VLAN, and if you leave the Tagged blank, the tag in frames will be deleted when transmitted from the VC.
- **Ethernet:** Select the Ethernet port as a member of VLAN.
- **Wireless LAN:** Select the wireless LAN port as a member of VLAN, and if you leave the Tagged blank, the tag in frames will be deleted when transmitted from the port.
- **VLAN Group Summary:** This displays the information about the VLAN Groups.

## 2) Assign VLAN PVID for each Interface

Click **Assign VLAN PVID for each Interface** in Figure 4-38, you can assign the PVID for each interface in the next screen (shown in Figure 4-40).

**PVID Assign**

ATM VC #0 : PVID 1

VC #1 : PVID 1

VC #2 : PVID 1

VC #3 : PVID 1

VC #4 : PVID 1

VC #5 : PVID 1

VC #6 : PVID 1

VC #7 : PVID 1

Ethernet Port #1 : PVID 1

Port #2 : PVID 1

Port #3 : PVID 1

Port #4 : PVID 1

Wireless LAN : PVID 1

SAVE CANCEL

Figure 4-40

- **PVID:** Each physical port has a default VID called PVID (Port VID). PVID is assigned to untagged frames or priority tagged frames (frames with null (0) VID) received on this port.

#### 4.4.6 ADSL

Choose “**Advanced Setup**→**ADSL**”, you can select the ADSL Type and ADSL Mode in the next screen. The ADSL feature can be selected when you meet the physical connection problem. Please check the proper settings with your Internet service provider.

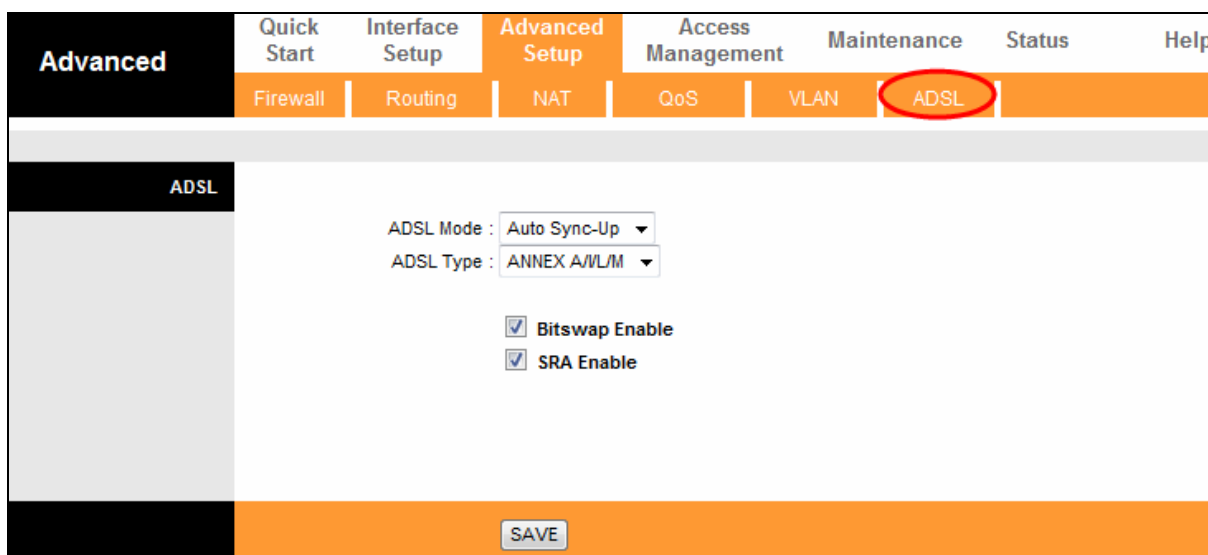

Figure 4-41

- **ADSL Mode:** Select the ADSL operation mode which your ADSL connection uses.
- **ADSL Type:** Select the ADSL operation type which your ADSL connection uses.

## 4.5 Access Management

Choose “**Access Management**”, you can see the next submenus:



Figure 4-42

Click any of them, and you will be able to configure the corresponding function.

### 4.5.1 ACL

Choose “**Access Management→ACL**”, you can see the next screen (shown in Figure 4-43). You can specify the client to access the ADSL modem router once setting his IP as a Secure IP Address through selected applications.

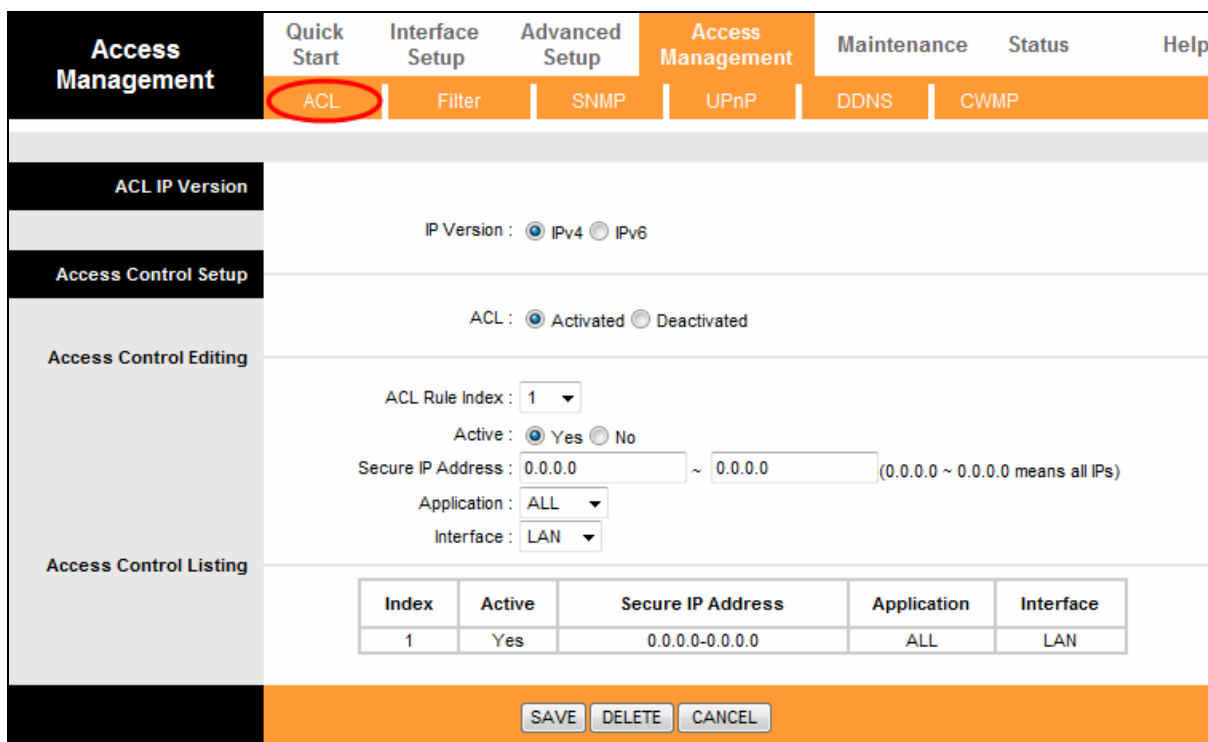

Figure 4-43

- **IP Version:** Select your IP version.

If you select IPv4 as IP version, you will see the screen shown below.

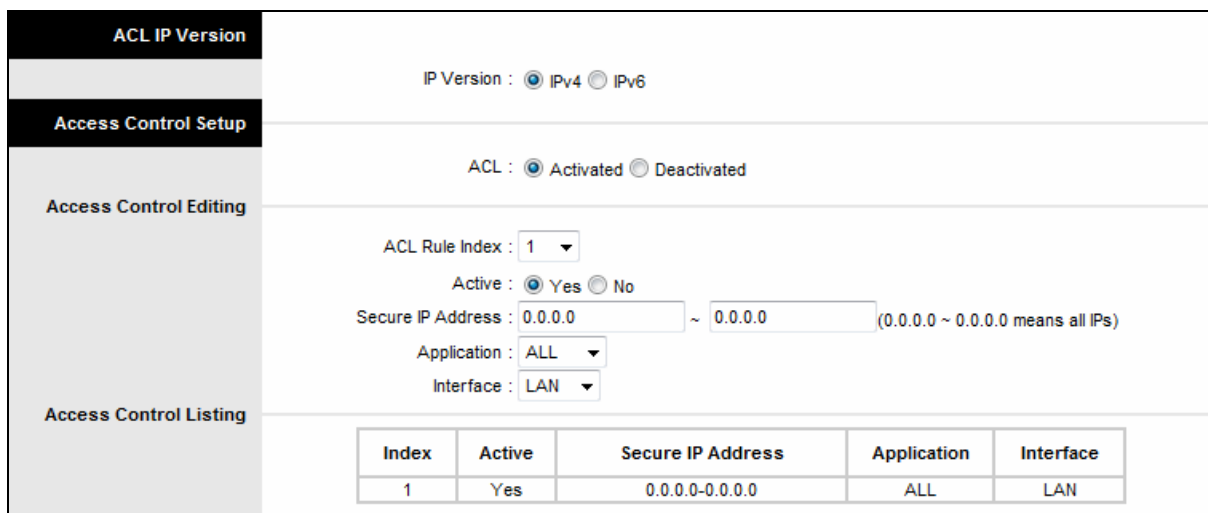

Figure 4-44

- **ACL:** If **Activated**, the IP addresses which are contained in the Access Control List can access to the modem router. If **Deactivated**, all IP addresses can access to the modem router.
- **ACL Rule Index:** Select the ACL rule index for the entry.
- **Active:** Enable the ACL rule.



- **Secure IP Address:** Select the IP addresses which are permitted to access to the modem router remotely. With the default IP 0.0.0.0, any client would be allowed to remotely access the ADSL modem router.
- **Application:** Select the application for the ACL rule, and then you can access the modem router through it.
- **Interface:** Select the interface for access: LAN, WAN or Both.
- **Access Control of Listing:** This displays the information about the ACL Rules.

If you select IPv6 as IP version, you will see the screen shown below.

The screenshot shows the IPv6 Access Control Setup page. On the left is a navigation menu with options: ACL IP Version, IPv6 Access Control Setup, IPv6 Access Control Editing, and IPv6 Access Control Listing. The main content area includes:

- IP Version:  IPv4  IPv6
- IPv6 ACL:  Activated  Deactivated
- IPv6 ACL Rule Index: 1 (dropdown)
- Active:  Yes  No
- Secure IPv6 Address:  /  (::<0 means all IPs)
- Application: ALL (dropdown)
- Interface: LAN (dropdown)

At the bottom, there is a table titled 'IPv6 Access Control Listing':

| Index | Active | Secure IPv6 Address | Application | Interface |
|-------|--------|---------------------|-------------|-----------|
| 1     | Yes    | :::0                | ALL         | LAN       |

Figure 4-45

- **IPv6 ACL:** If **Activated**, the IPv6 addresses which are contained in the Access Control List can access to the modem router. If **Deactivated**, all IP addresses can access to the modem router.
- **IPv6 ACL Rule Index:** Select the ACL rule index for the entry.
- **Active:** Enable the ACL rule.
- **Secure IPv6 Address:** Select the IPv6 addresses which are permitted to access to the modem router remotely.
- **Application:** Select the application for the IPv6 ACL rule, and then you can access the modem router through it.
- **Interface:** Select the interface for access: LAN, WAN or Both.
- **IPv6 Access Control of Listing:** This displays the information about the IPv6 ACL Rules.

#### 4.5.2 Filter

Choose “**Access Management**→**Filter**”, you can see the Filter screen (the default is IP/MAC Filter screen shown in Figure 4-46 ). The filtering feature includes IP/MAC Filter, Application Filter,

and URL Filter. The feature makes it possible for administrators to control user's access to the Internet, protect the networks.

#### 4.5.2.1 IP Filter

Select **IP/MAC Filter** as the Filter type, and select **IP** as the Rule type (shown in Figure 4-46), then you can configure the filter rules based on IP address. The filtering includes **Outgoing** and **Incoming**, the detailed descriptions are provided below.

The screenshot shows the configuration page for IP/MAC filters. The 'Filter' tab is active. The 'Filter Type Selection' dropdown is set to 'IP / MAC Filter'. The 'IP / MAC Filter Set Editing' section shows 'IP / MAC Filter Set Index' as 1, 'Interface' as PVC0, and 'Direction' as Both. The 'IP / MAC Filter Rule Editing' section shows 'IP / MAC Filter Rule Index' as 1, 'Rule Type' as IP, and 'Active' as No. Below are fields for Source and Destination IP Address, Subnet Mask, and Port Number. The 'Protocol' is set to TCP and 'Rule Unmatched' is set to Forward. At the bottom, there is a table for 'IP / MAC Filter Listing' and buttons for 'SAVE', 'DELETE', and 'CANCEL'.

| IP / MAC Filter Set Index |        | Interface        |              | Direction |           |          |           |
|---------------------------|--------|------------------|--------------|-----------|-----------|----------|-----------|
| #                         | Active | Src Address/Mask | Dest IP/Mask | Src Port  | Dest Port | Protocol | Unmatched |
| 1                         | -      | -                | -            | -         | -         | -        | -         |
| 2                         | -      | -                | -            | -         | -         | -        | -         |
| 3                         | -      | -                | -            | -         | -         | -        | -         |
| 4                         | -      | -                | -            | -         | -         | -        | -         |
| 5                         | -      | -                | -            | -         | -         | -        | -         |
| 6                         | -      | -                | -            | -         | -         | -        | -         |

Figure 4-46

- **Filter Type Selection:** Select the filter type for the configuration below.
- **IP/MAC Filter Set Index:** Select the Set index for the IP Filter entry. This index can match with six IP / MAC Filter Rule Indexes.
- **Interface:** Select the interface for the entry.

 **Note:**

If select PVC0~PVC7 as an interface, the filter will match the IP traffic of WAN port with specified IPs (Source IP Address and Destination IP Address). If select LAN as an interface, the filter will match the IP traffic of LAN port with specified IPs.

- **Direction:** Select the direction for this IP Filter rule. There are three filtering directions: Both, Incoming, Outgoing.

 **Note:**

Incoming means that IP traffic which is coming into the modem router, and the Outgoing means that IP traffic which is going out the modem router.

- **IP/MAC Filter Rule Index:** Select the Rule index for the IP Filter entry.

 **Note:**

You should set the **IP/MAC Filter Set Index** and **IP/MAC Filter Rule Index** together to appoint the address (shown in the Filter List) for the IP Filter rule. For example, (1, 2), it means the rule will be shown in the row 2 IP/MAC Filter Set Index 1.

- **Rule Type:** For IP Filter, please select IP here.
- **Active:** Select “Yes” to make the rule to take effect.
- **Source IP Address:** Enter the source IP address for the rule. You can enter 0.0.0.0; it means that all IP addresses are controlled by the rule.
- **Destination IP Address:** Enter the destination IP address for the rule. You can enter 0.0.0.0, which means that all IP addresses are controlled by the rule. The set of Subnet Mask and Port Number are same as Source IP Address.
- **Subnet Mask:** Enter the Subnet Mask for the rule.
- **Port Number:** Enter the Port Number for the rule. You can enter 0, which means that all ports are controlled by the rule.
- **Protocol:** Select the protocol: **TCP**, **UDP** or **ICMP** for the filter rule.
- **Rule Unmatched:** If the current rule can not match, and you select **Forward**, the modem router will skip the rule and transmit directly. If you select **Next**, the modem router will find the next filter rule (show in Filter list) to match.
- **IP/MAC Filter Listing:** This displays the information about the IP Filter rules.

**To add an IP Address filtering entry:**

**For example:** If you desire to block E-mail received and sent by the IP address 192.168.1.7 on your local network; And wish to make the PCs with IP address 192.168.1.8 unable to visit the

website of IP address 202.96.134.12, while other PCs have no limit. You can configure the rules as follows. Presume the rules are both aimed at the interface PVC0, and their indexes are (1, 1), (1, 2) and (1, 3).

**Step 1:** Select the “IP/MAC Filter” as the Filter Type Selection (show in Figure 4-46).

Filter Type Selection : IP / MAC Filter

Select the “IP” as the Rule Type on the Filter screen, then you can configure the specific rule for the example.

Rule Type : IP

**Step 2:** Select the **IP/MAC Filter Set Index** and **IP/MAC Filter Rule Index** for the rule, then select the Interface “PVC0”, and select the Direction “Both” for the first rule.

IP / MAC Filter Set Index : 1  
 Interface : PVC0  
 Direction : Both

IP / MAC Filter Rule Index : 1  
 Rule Type : IP  
 Active :  Yes  No

**Note:**

If you want to make the rule take effect, please select **Yes** to activate the rule.

**Step 3:** Enter the “Source IP Address”, “Destination IP Address”, “Subnet Mask” and “Port Number” in the corresponding field.

Source IP Address : 192.168.1.7 (0.0.0.0 means Don't care)  
 Subnet Mask : 255.255.255.255  
 Port Number : 0 (0 means Don't care)

Destination IP Address : 0.0.0.0 (0.0.0.0 means Don't care)  
 Subnet Mask : 0.0.0.0  
 Port Number : 25 (0 means Don't care)

Protocol : TCP  
 Rule Unmatched : Next

**Step 4:** Select the Protocol as “TCP” and select the Unmatched rule as “Next”.

**Step 5:** Finally, click the **SAVE** to save the entry.

**Step 6:** Go to Step 2 to configure the next two rules: Block E-mail received by the IP address 192.168.1.7 on your local network; Make the PC with IP address 192.168.1.8 unable to visit the website of IP address 202.96.134.12.

 **Note:**

After you complete the IP filter rules for the example, the Filter list will show as follows. You can enter the **IP / MAC Filter Set Index** to view the information about the rule.

| # | Active | Src Address/Mask                | Dest IP/Mask                      | Src Port | Dest Port | Protocol | Unmatched |
|---|--------|---------------------------------|-----------------------------------|----------|-----------|----------|-----------|
| 1 | Yes    | 192.168.1.7/<br>255.255.255.255 | 0.0.0.0/<br>0.0.0.0               | 0        | 25        | TCP      | Next      |
| 2 | Yes    | 192.168.1.7/<br>255.255.255.255 | 0.0.0.0/<br>0.0.0.0               | 0        | 110       | TCP      | Forward   |
| 3 | Yes    | 192.168.1.8/<br>255.255.255.255 | 202.96.134.12/<br>255.255.255.255 | 0        | 0         | TCP      | Forward   |

**Other operations for the entries as shown in Figure 4-46:**

Select the **IP / MAC Filter Set Index** and **IP/MAC Filter Rule Index** to view or modify the entry.  
 Select the **IP / MAC Filter Set Index** and **IP/MAC Filter Rule Index** to locate the specific rule, and then click the **DELETE** button to delete the entry.

**4.5.2.2 MAC Filter**

Select **IP/MAC Filter** as the Filter type, and select **MAC** as the Rule type (shown in Figure 4-47), and then you can configure the filter rules based on MAC address.

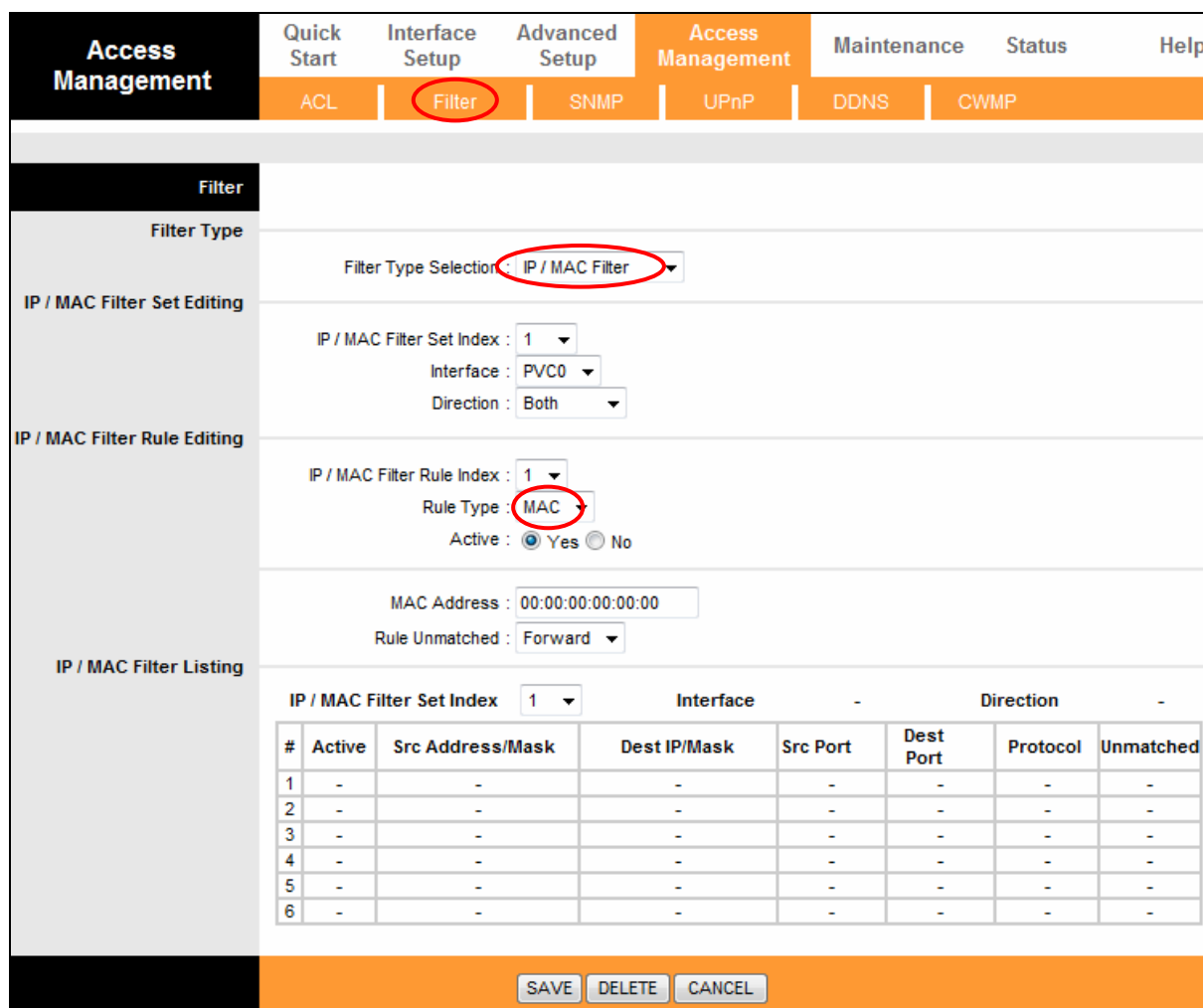

Figure 4-47

- **Rule Type:** Select MAC for the MAC Filter rule.
- **Active:** Select “Yes” to make the rule to take effect.
- **MAC Address:** Enter the MAC address for the rule.
- **Rule Unmatched:** If the current rule can not match, and you select **Forward**, the modem router will skip the rule and transmit directly. If you select **Next**, the modem router will find the next filter rule (show in Filter list) to match.
- **IP/MAC Filter Listing:** This displays the information about the MAC Filter rules.

**To add a MAC Address filtering entry:**

**For example:** If you want to block the PCs with MAC addresses 00:0A:EB:00:07:BE and 00:0A:EB:00:07:5F to access the Internet, you can configure as follows. Presume the rules are both aimed at the interface PVC0, and their indexes are (1, 1) and (1, 2).

**Step 1:** Select the “IP/MAC Filter” as the Filter Type Selection:

Filter Type Selection : IP / MAC Filter

Select the “MAC” as the Rule Type on the Filter screen (show in Figure 4-47).

Rule Type : MAC

, Then you can configure the specific rule for the example.

**Step 2:** Select the **IP/MAC Filter Set Index** and **IP/MAC Filter Rule Index** for the rule, then select the Interface “PVC0”, and select the Direction “Outgoing” for the first rule.

IP / MAC Filter Set Index : 1  
 Interface : PVC0  
 Direction : Outgoing

---

IP / MAC Filter Rule Index : 1  
 Rule Type : MAC  
 Active :  Yes  No

**Note:**

If you want to make the rule take effect, please select **Yes** to activate the rule.

**Step 3:** Enter the “MAC Address” and select the Rule Unmatched as “Next”.

MAC Address : 00:0A:EB:00:07:BE  
 Rule Unmatched : Next

**Step 4:** Finally, click the **SAVE** to save the entry.

**Step 5:** Go to Step 2 to configure the next rule: Block the PC with MAC address 00:0A:EB:00:07:5F to access the Internet.

**Note:**

After you complete the MAC filter rules for the example, the Filter list will show as follows. You can enter the **IP / MAC Filter Set Index** to view the information about the rule.

| # | Active | Src Address/Mask  | Dest IP/Mask | Src Port | Dest Port | Protocol | Unmatched |
|---|--------|-------------------|--------------|----------|-----------|----------|-----------|
| 1 | Yes    | 00:0a:eb:00:07:be | -            | -        | -         | -        | Next      |
| 2 | Yes    | 00:0a:eb:00:07:5f | -            | -        | -         | -        | Forward   |

**Other operations for the entries as shown in Figure 4-46:**

Select the **IP / MAC Filter Set Index** and **IP/MAC Filter Rule Index** to view or modify the entry.

Select the **IP / MAC Filter Set Index** and **IP/MAC Filter Rule Index** to locate the specific rule, and then click the **DELETE** button to delete the entry.

### 4.5.2.3 Application Filter

Select **Application Filter** as the Filter type (shown in Figure 4-48), and then you can configure the filter rules based on application.

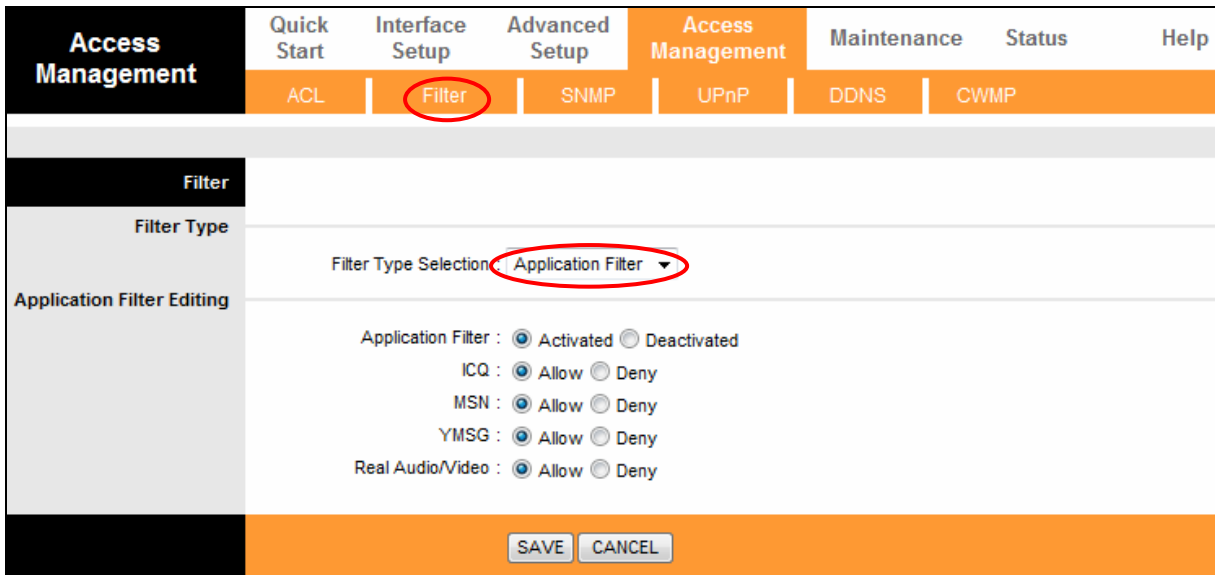

Figure 4-48

- **Filter Type Selection:** Select the Application Filter for the next configuration.
- **Application Filter:** Activate or deactivate the function.
- **ICQ & MSN & YMSG & Real Audio/Video:** Select **Allow** or **Deny** for these applications. If you select Allow, the modem router will accept the application; if you select Deny, the modem router will forbid the application.

### 4.5.2.4 URL

Select **URL Filter** as the Filter type (shown in Figure 4-49), and then you can configure the filter rules based on URL.



**Filter**

**Filter Type**

Filter Type Selection: **URL Filter**

**URL Filter Editing**

Active :  Yes  No

URL Index : 3

URL :

**URL Filter Listing**

| Index | URL                    |
|-------|------------------------|
| 1     | http://www.baidu.com/  |
| 2     | http://www.cnw.com.cn/ |
| 3     |                        |
| 4     |                        |
| 5     |                        |
| 6     |                        |
| 7     |                        |
| 8     |                        |
| 9     |                        |
| 10    |                        |
| 11    |                        |
| 12    |                        |
| 13    |                        |
| 14    |                        |
| 15    |                        |
| 16    |                        |

SAVE DELETE CANCEL

Figure 4-49

- **Filter Type Selection:** Select the URL Filter for the next configuration.
- **Active:** Select “Yes” to make the rule to take effect.
- **URL Index:** Select the index for the URL Filter entry.
- **URL:** Enter the URL for this URL Filter.
- **URL Filter Listing:** This displays the information about the URL Filter rules.

#### To add a URL filter entry:

**For example:** If you want to forbid the user to access the website: [www.sina.com](http://www.sina.com). Presume the rule is aimed at the interface PVC0, and its index is “1”.

**Step 1:** Select the “URL Filter” as the Filter Type Selection (show in Figure 4-49).

**Step 2:** Select the Index for the rule, and then enter the website in the URL field.

**Step 3:** Finally, Select **Yes** to activate the rule, and then click the **SAVE** to save the entry.

#### Other operations for the entries as shown in Figure 4-46:

Select the **URL Index** to view or modify the entry.

Select the **URL Index** to locate the specific rule, and then click the **DELETE** button to delete the entry.

### 4.5.3 SNMP

Choose “**Access Management**→**SNMP**”, you can see the SNMP screen. The Simple Network Management Protocol (SNMP) is used for exchanging information between network devices.

| Access Management | Quick Start | Interface Setup | Advanced Setup | Access Management | Maintenance | Status | Help |
|-------------------|-------------|-----------------|----------------|-------------------|-------------|--------|------|
|                   | ACL         | Filter          | SNMP           | UPnP              | DDNS        | CWMP   |      |

| SNMP  |
|---|
| SNMP : <input checked="" type="radio"/> Activated <input type="radio"/> Deactivated<br>Get Community : <input type="text" value="public"/><br>Set Community : <input type="text" value="public"/><br>Trap Host : <input type="text" value="0.0.0.0"/> |
| <input type="button" value="SAVE"/>   |

Figure 4-50

- **Get Community:** Set the password for the incoming Get and Get next requests from the management station.
- **Set Community:** Set the password for incoming Set requests from the management station.

### 4.5.4 UPnP

Choose “**Access Management**→**UPnP**”, you can configure the UPnP in the screen (shown in Figure 4-51).

UPnP (Universal Plug and Play) is a distributed, open networking standard that uses TCP/IP for simple peer-to-peer network connectivity between devices. An UPnP device can dynamically join a network, obtain an IP address, convey its capabilities and learn about other devices on the network. In turn, a device can leave a network smoothly and automatically when it is no longer in use. UPnP broadcasts are only allowed on the LAN.

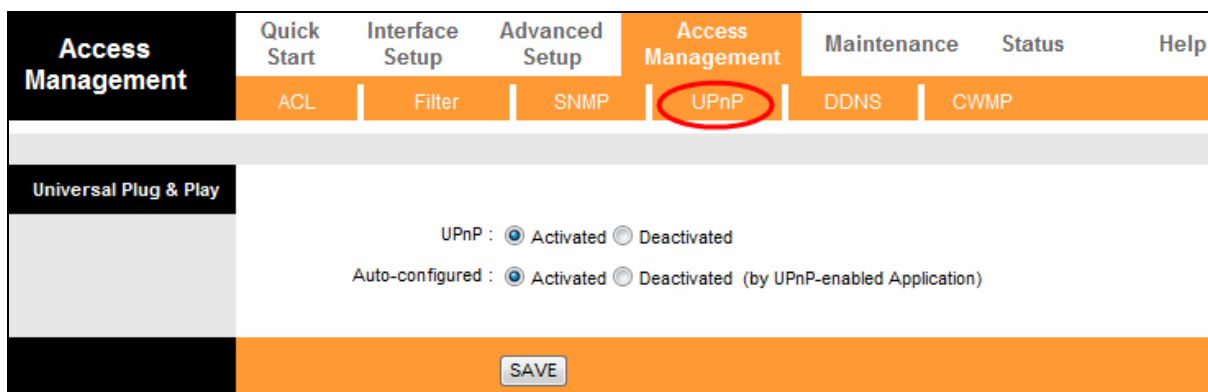

Figure 4-51

- **UPnP:** Activate or Deactivate the UPnP function. Only when the function is activated, can the UPnP take effect.
- **Auto-Configure:** If you activate the function, then the UPnP network devices can automatically configure network addressing, announce their presence in the network to other UPnP devices and enable exchange of simple product and service descriptions.

#### 4.5.5 DDNS

Choose “**Access Management**→**DDNS**”, you can configure the DDNS function in the screen (shown in Figure 4-52).

The modem router offers a Dynamic Domain Name System (**DDNS**) feature. The feature lets you use a static host name with a dynamic IP address. User should type the host name, user name and password assigned to your ADSL modem router by your Dynamic DNS provider.

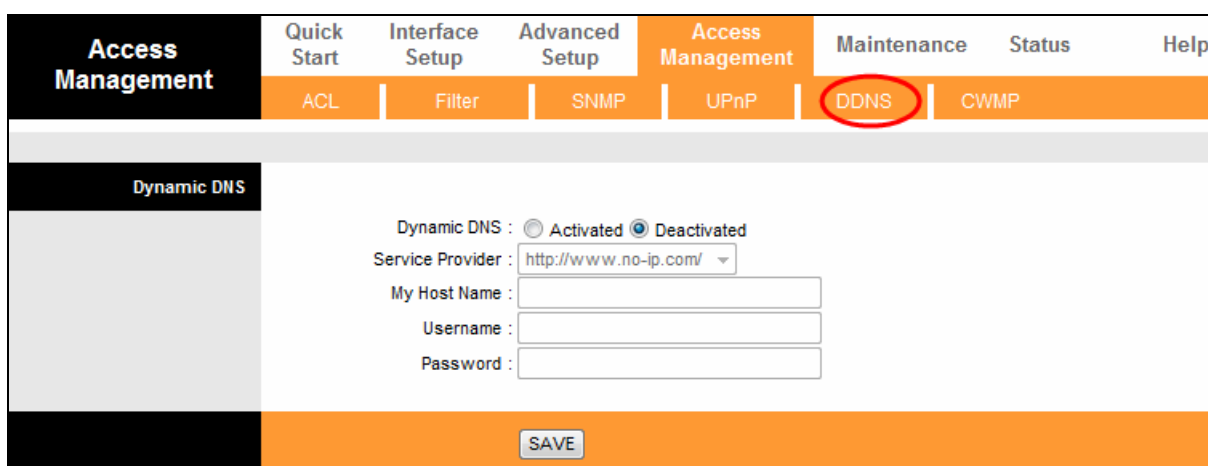

Figure 4-52

- **Dynamic DNS:** Activate the DDNS function or not.
- **Service Provider:** This field displays the service provider of DDNS.
- **My Host Name:** Enter your host name here.
- **Username & Password:** Type the “User Name” and “Password” for your DDNS account.

#### 4.5.6 CWMP

Choose “**Access Management**→**CWMP**”, you can configure the CWMP function in the screen (shown in Figure 4-53).

The modem router offers CWMP feature. The function supports TR-069 protocol which collects information, diagnoses the devices and configures the devices automatically via ACS (Auto-Configuration Server).

| Access Management | Quick Start | Interface Setup | Advanced Setup | Access Management | Maintenance | Status      | Help |
|-------------------|-------------|-----------------|----------------|-------------------|-------------|-------------|------|
|                   | ACL         | Filter          | SNMP           | UPnP              | DDNS        | <b>CWMP</b> |      |

| CWMP Setup  |  |
|---|--|
|   | CWMP : <input type="radio"/> Activated <input checked="" type="radio"/> Deactivated  |
| Login ACS   | URL : <input type="text" value="http://0/"/><br>User Name : <input type="text"/><br>Password : <input type="text"/>  |
| Connection Request  | Path : <input type="text" value="/tr069"/><br>Port : <input type="text" value="7547"/><br>UserName : <input type="text"/><br>Password : <input type="text"/> |
| Periodic Inform   | Periodic Inform : <input checked="" type="radio"/> Activated <input type="radio"/> Deactivated<br>Interval(s) : <input type="text" value="86400"/>           |
| <input type="button" value="SAVE"/> <input type="button" value="CANCEL"/> |  |

Figure 4-53

- **CWMP:** Select activate the CWMP function.
- **URL:** Enter the website of ACS which is provided by your ISP.
- **User Name/Password:** Enter the User Name and password to login the ACS server.
- **Path:** Enter the path that connects to the ACS server.
- **Port:** Enter the port that connects to the ACS server.
- **User Name/Password:** Enter the User Name and Password that provided the ACS server to login the modem router.
- **Periodic Inform:** Activate or deactivate the function. If Activated, the information will be informed to ACS server periodically.
- **Interval:** Enter the interval time here.

## 4.6 Maintenance

Choose “**Maintenance**”, you can see the next submenus:



Figure 4-54

Click any of them, and you will be able to configure the corresponding function.

### 4.6.1 Administration

Choose “**Maintenance**→**Administration**”, you can set new password for admin in the screen (shown in Figure 4-55).

Figure 4-55

#### Note:

- 1) There is only one account that can access Web-Management interface. The default account is "admin", and the password is "admin". Admin has read/write access privilege.
- 2) When you change the password, you should enter the new password twice, and then click **SAVE** to make the new password take effect.

### 4.6.2 Time Zone

Choose “**Maintenance**→**Time Zone**”, you can configure the system time in the screen (shown in Figure 4-56).

The system time is the time used by the device for scheduling services. There are three methods to configure the time. You can manually set the time or connect to a NTP (Network Time Protocol) server. If a NTP server is set, you will only need to set the time zone. If you manually set the time, you may also set Daylight Saving dates and the system time will automatically adjust on those dates.

### 1) NTP Server automatically

Select **NTP Server automatically** as the Synchronize time, you only need to set the time zone.

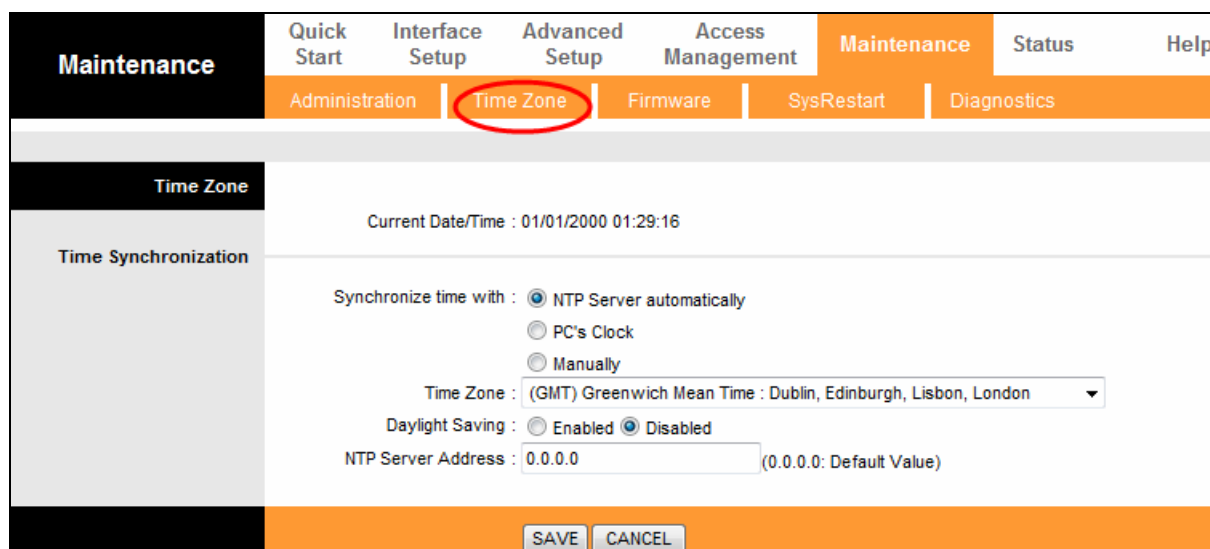

Figure 4-56

**Note:**

The ADSL modem router built-in some NTP Servers, when the modem router connects to the Internet, the modem router will get the system time automatically from the NTP Server. You can also configure the NTP Server address manually, and then the modem router will get the time from the specific Server firstly.

### 2) PC's Clock

Select **PC's Clock** as the Synchronize time, you don't need to set any items.

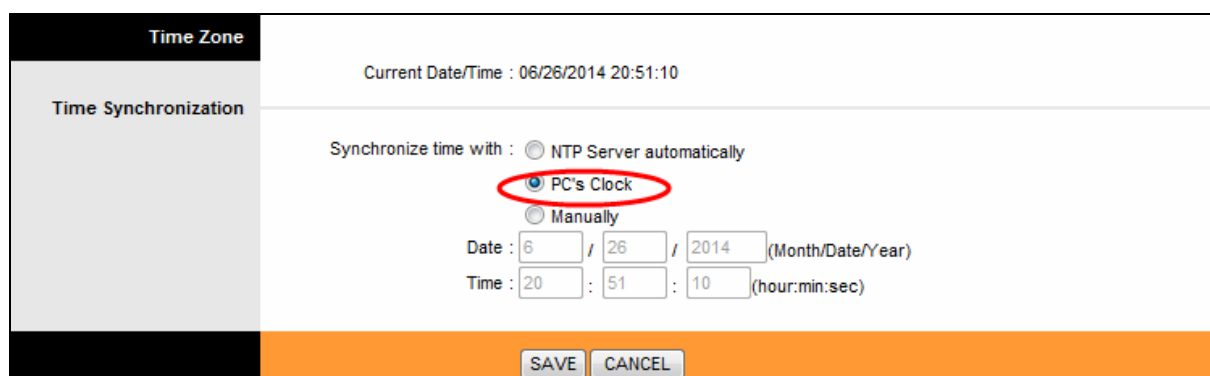

Figure 4-57

### 3) Manually

Select **Manually** as the Synchronize time, you need to set the date and time corresponding to the current time.

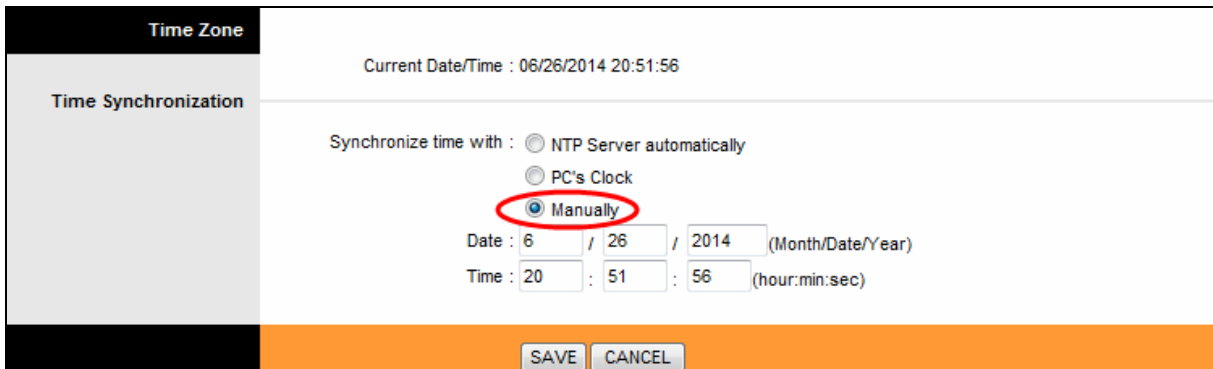

Figure 4-58

### 4.6.3 Firmware

Choose “**Maintenance**→**Firmware**”, you can upgrade the firmware of the modem router in the screen (shown in Figure 4-59). Make sure the firmware or romfile you want to use is on the local hard drive of the computer. Click **Browse** to find the local hard drive and locate the firmware or romfile to be used for upgrade.

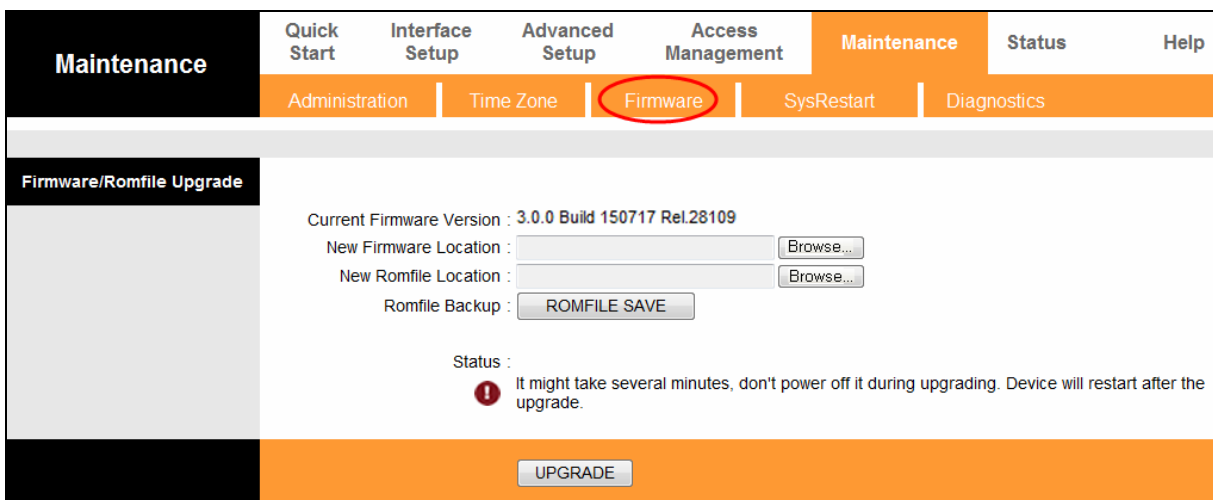

Figure 4-59

To upgrade the modem router's firmware, follow these instructions below:

**Step 1:** Type the path and file name of the update file into the “New Firmware Location” field. Or click the **Browse** button to locate the update file.

**Step 2:** Click the **UPGRADE** button.

**Note:**

- 1) When you upgrade the modem router's firmware, you may lose its current configurations, so please back up the modem router's current settings before you upgrade its firmware.
- 2) Do not turn off the modem router or press the Reset button while the firmware is being upgraded.

3) The modem router will reboot after the upgrading has been finished.

**To back up the modem router’s current settings:**

**Step 1:** Click the **ROMFILE SAVE** button (shown in Figure 4-59), click **Save** button in the next screen (shown in Figure 4-60) to proceed.

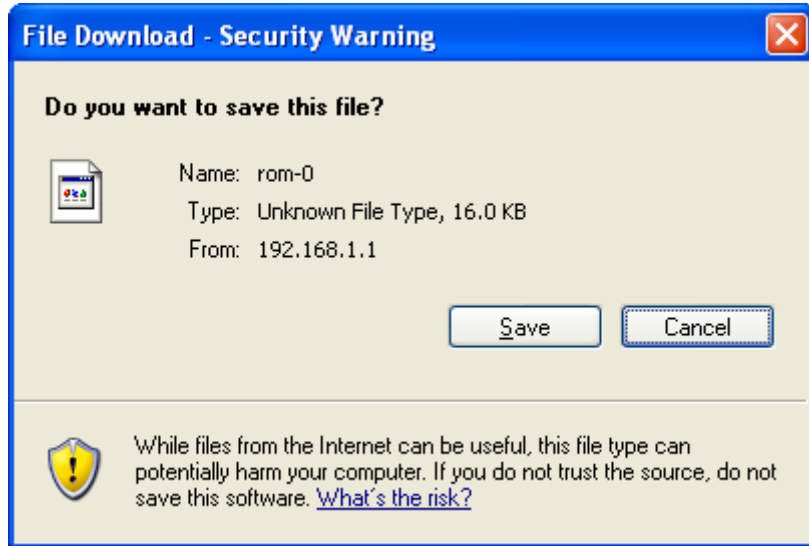

Figure 4-60

**Step 2:** Save the file as the appointed file (shown in Figure 4-61).

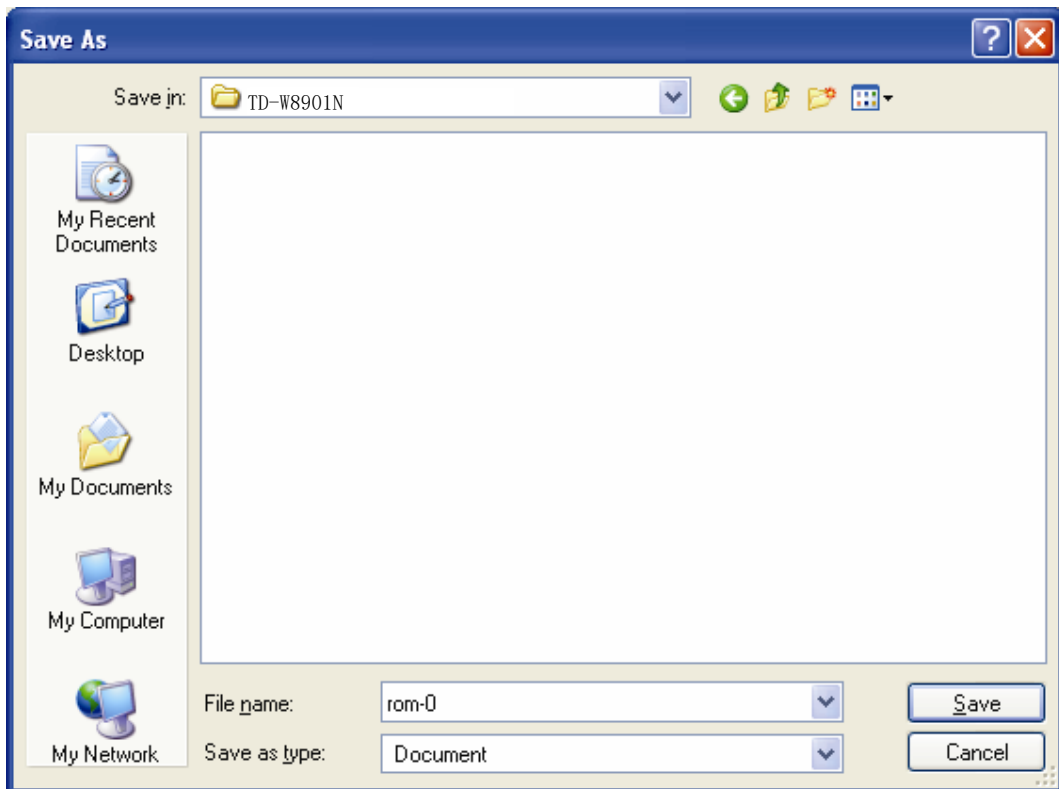

Figure 4-61



To restore the modem router's settings:

**Step 1:** Click the **Browse** button to locate the update file for the device, or enter the exact path in "New Romfile Location" field.

**Step 2:** Click the **UPGRADE** button to complete.

#### 4.6.4 SysRestart

Choose "**Maintenance**→**SysRestart**", you can select to restart the device with current settings or restore to factory default settings in the screen (shown in Figure 4-62).

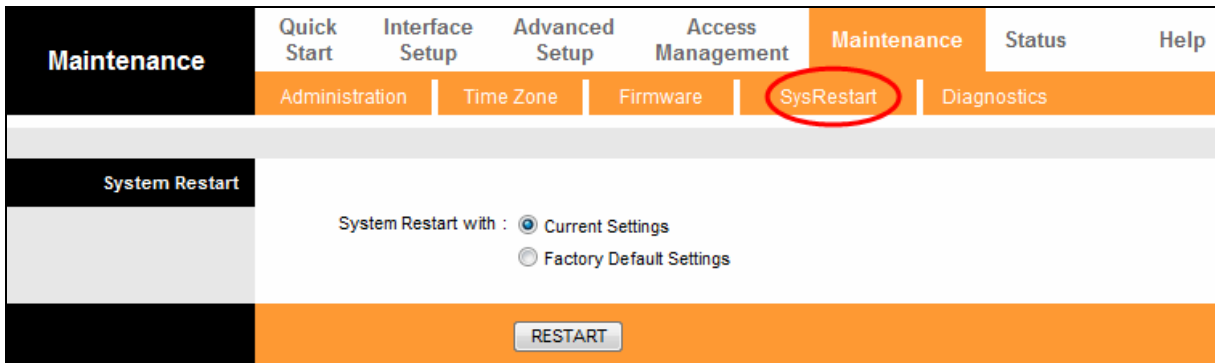

Figure 4-62

#### 4.6.5 Diagnostics

Choose "**Maintenance**→**Diagnostics**", you can view the test results for the connectivity of the physical layer and protocol layer for both LAN and WAN sides in the screen (shown in Figure 4-63).

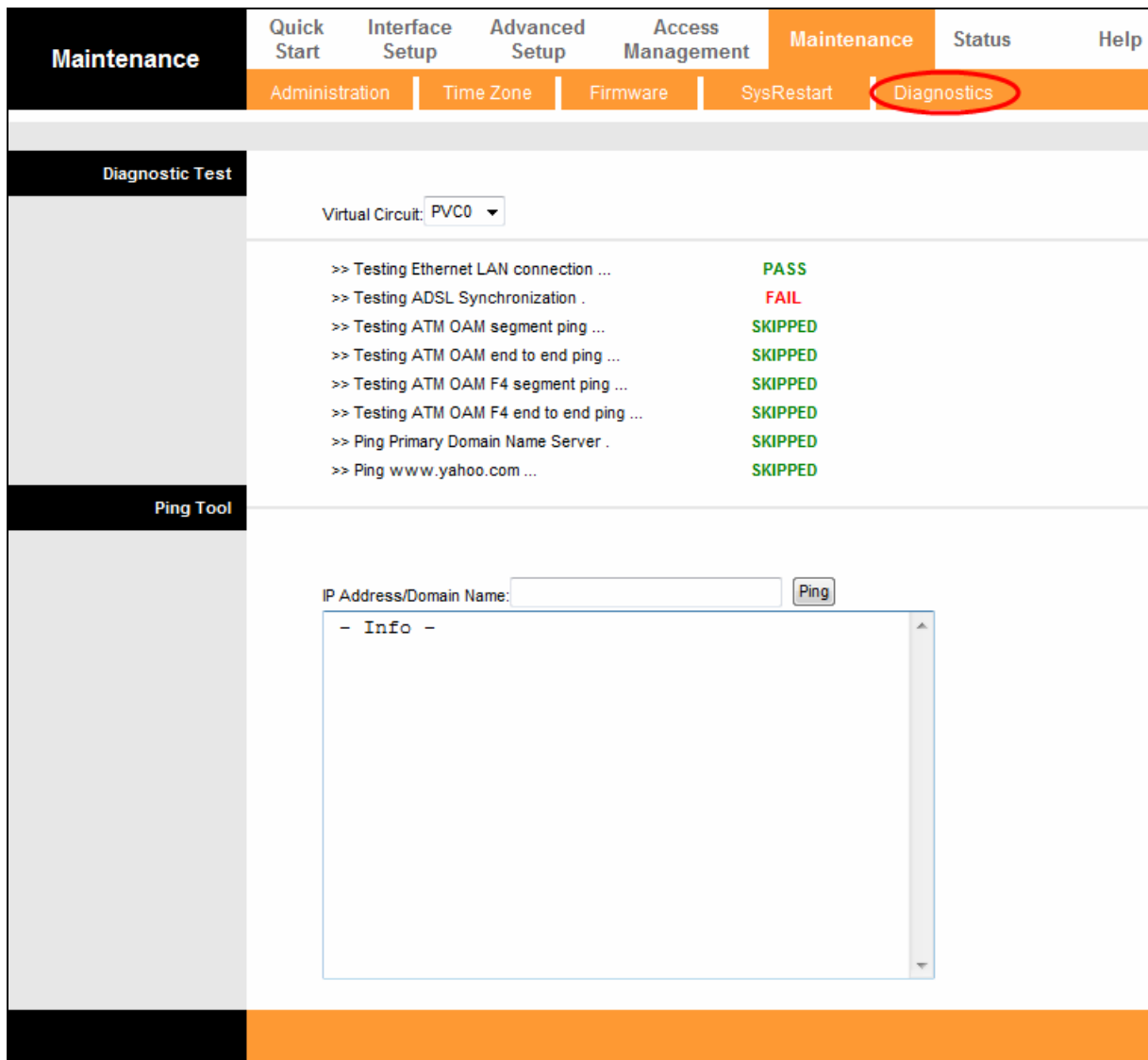

Figure 4-63

## 4.7 Help

Choose “Help”, you can view the help information for configuration of any function.







| Help                     | Quick Start  | Interface Setup | Advanced Setup | Access Management | Maintenance | Status | Help |
|--------------------------|--|-----------------|----------------|-------------------|-------------|--------|------|
| <b>Quick Start</b>       | <ul style="list-style-type: none"> <li>▶ Quick Start</li> </ul>  |                 |                |                   |             |        |      |
| <b>Interface Setup</b>   | <ul style="list-style-type: none"> <li>▶ Internet Settings</li> <li>▶ LAN Settings</li> <li>▶ Wireless LAN Settings</li> </ul>                           |                 |                |                   |             |        |      |
| <b>Advanced Setup</b>    | <ul style="list-style-type: none"> <li>▶ Firewall</li> <li>▶ Routing</li> <li>▶ NAT</li> <li>▶ QoS</li> <li>▶ VLAN</li> <li>▶ ADSL</li> </ul>            |                 |                |                   |             |        |      |
| <b>Access Management</b> | <ul style="list-style-type: none"> <li>▶ ACL</li> <li>▶ IP Filter</li> <li>▶ SNMP</li> <li>▶ UPnP</li> <li>▶ DDNS</li> <li>▶ CWMP</li> </ul>             |                 |                |                   |             |        |      |
| <b>Maintenance</b>       | <ul style="list-style-type: none"> <li>▶ Administration</li> <li>▶ Time Zone</li> <li>▶ Firmware</li> <li>▶ SysRestart</li> <li>▶ Diagnostics</li> </ul> |                 |                |                   |             |        |      |
| <b>Status</b>            | <ul style="list-style-type: none"> <li>▶ Device Info</li> <li>▶ System Log</li> <li>▶ Statistics</li> </ul>  |                 |                |                   |             |        |      |

Figure 4-64

 **Note:**

Click the tab, and you will be able to get the corresponding information.

## Appendix A: Specifications

| General                  |  |
|--------------------------|--|
| Standards and Protocols  | ANSI T1.413, ITU G.992.1, ITU G.992.2, ITU G.992.3, ITU G.992.5, IEEE 802.11b, IEEE 802.11g, IEEE 802.11n, IEEE 802.3, IEEE 802.3u, TCP/IP, PPPoA, PPPoE, SNTP, HTTP, DHCP, ICMP, NAT  |
| Safety & Emission        | FCC, CE  |
| Ports                    | Four 10/100M Auto-Negotiation RJ45 ports (Auto MDI/MDIX)<br>One RJ11 port  |
| LEDs                     |  (Power),  (ADSL),  (Internet),  (WLAN),  (WPS),  (LAN1-4) |
| Network Medium           | 10Base-T: UTP category 3, 4, 5 cable<br>100Base-TX: UTP category-5<br>Max line length: 6.5Km   |
| Data Rates               | Downstream: Up to 24Mbps<br>Upstream: Up to 2.5Mbps (With Annex M enabled)   |
| Antenna                  | One 2.4GHz 5dBi undetachable antennas(Weld)  |
| Physical and Environment |  |
| Working Temperature      | 0°C ~ 40°C   |
| Working Humidity         | 10% ~ 90% RH (non-condensing)  |
| Storage Temperature      | -40°C ~ 70°C   |
| Storage Humidity         | 5% ~ 90% RH (non-condensing)   |

## Appendix B: Troubleshooting

### T1. How do I restore my Modem Router's configuration to its factory default settings?

With the modem router powered on, press and hold the **RESET** button on the rear panel for 8 to 10 seconds before releasing it.

 **Note:**

Once the modem router is reset, the current configuration settings will be lost and you will need to re-configure the modem router.

### T2. What can I do if I don't know or forget my password?

- 1) Restore the modem router's configuration to its factory default settings. If you don't know how to do that, please refer to **T1**.
- 2) Use the default user name and password: **admin, admin**.
- 3) Try to configure your modem router once again by following the instructions in [3.2 Login](#).

### T3. What can I do if I cannot access the web-based configuration page?

1. Configure your computer's IP Address.

#### For Mac OS X

- 1) Click the **Apple** icon on the upper left corner of the screen.
- 2) Go to "**System Preferences -> Network**".
- 3) Select **Airport** on the left menu bar, and then click **Advanced** for wireless configuration; or select **Ethernet** for wired configuration.
- 4) In the **Configure IPv4** box under **TCP/IP**, select **Using DHCP**.
- 5) Click **Apply** to save the settings.



#### For Windows 7

- 1) Click "**Start -> Control Panel -> Network and Internet -> View network status -> Change adapter settings**".
- 2) Right-click Wireless Network Connection (or Local Area Connection), and then click Properties.
- 3) Select Internet Protocol Version 4 (TCP/IPv4), and then click Properties.
- 4) Select Obtain an IP address automatically and Obtain DNS server address automatically. Then click OK.

**For Windows XP**

- 1) Click “**Start -> Control Panel -> Network and Internet Connections -> Network Connections**”.
- 2) Right-click Wireless Network Connection (or Local Area Connection), and then click Properties.
- 3) Select Internet Protocol (TCP/IP), and then click Properties.
- 4) Select Obtain an IP address automatically and Obtain DNS server address automatically. Then click OK.

**For Windows 8**

- 1) Move your mouse to the lower right corner and you will see **Search** icon  in the Popups. Go to “ -> **Apps**”. Type **Control Panel** in the search box and press **Enter**, then you will go to **Control Panel**.
  - 2) Click “View network status and tasks > Change adapter settings”.
  - 3) Right-click “Ethernet” and then select Properties.
  - 4) Double-click Internet Protocol Version 4 (TCP/IPv4). Select Obtain an IP address automatically, choose Obtain DNS server address automatically and then click OK.
2. Configure your IE browser

Open your IE browser, click **Tools** tab and you will see the following screen.

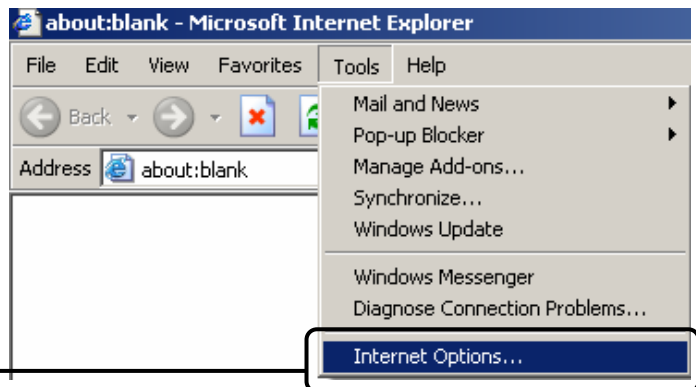

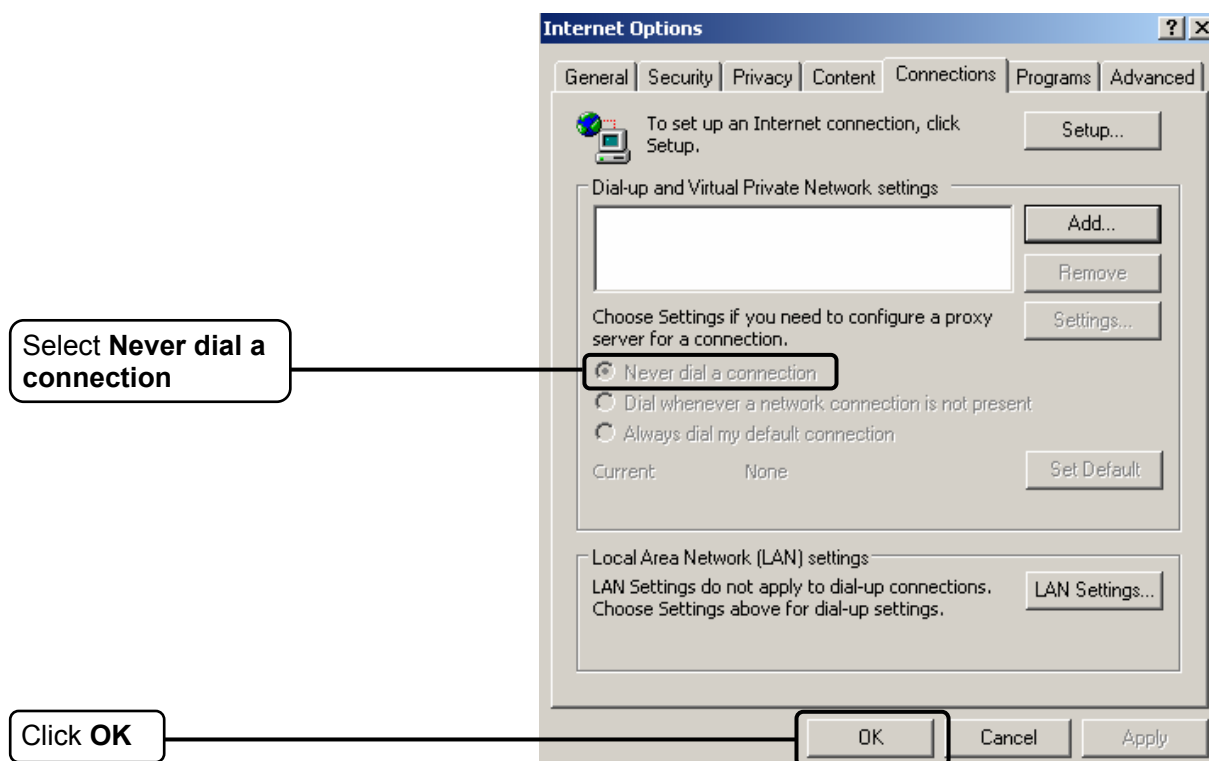

Now, try to log on to the Web-based configuration page again after the above settings have been configured. If you still cannot access the configuration page, please restore your modem router's factory default settings and reconfigure your modem router following the instructions in [3.2 Login](#). Please feel free to contact our Technical Support if the problem persists.

#### T4. What can I do if I cannot access the Internet?

- 1) Check to see if all the connectors are connected well, including the telephone line, Ethernet cables and power adapter.
- 2) Check to see if you can log on to the web management page of the Modem Router. If you can, try the following steps. If you cannot, please set your computer referring to **T3** then try to see if you can access the Internet. If the problem persists, please go to the next step.
- 3) Consult your ISP and make sure all the VPI/VCI, Connection Type, account username and password are correct. If there are any mistakes, please correct the settings and try again.
- 4) If you still cannot access the Internet, please restore your modem router to its factory default settings and reconfigure your modem router by following the instructions of in [3.2 Login](#).
- 5) Please feel free to contact our Technical Support if the problem still exists.

#### Note:

For more details about Troubleshooting and Technical Support contact information, please log on to our Technical Support Website: <http://www.tp-link.com/en/support>

## Appendix C: Technical Support

### Technical Support

- For more troubleshooting help, go to:  
<http://www.tp-link.com/en/support/faq>
- To download the latest Firmware, Driver, Utility and User Guide, go to:  
<http://www.tp-link.com/en/support/download>
- For all other technical support, please contact us by using the following details:

#### Global

Tel: +86 755 2650 4400  
 Fee: Depending on rate of different carriers, IDD.  
 E-mail: [support@tp-link.com](mailto:support@tp-link.com)  
 Service time: 24hrs, 7 days a week

#### USA/Canada

Toll Free: +1 866 225 8139  
 E-mail: [support.usa@tp-link.com](mailto:support.usa@tp-link.com)(USA)  
[support.ca@tp-link.com](mailto:support.ca@tp-link.com)(Canada)  
 Service time: 24hrs, 7 days a week

#### Turkey

Tel: 0850 7244 488 (Turkish Service)  
 Fee: Depending on rate of different carriers.  
 E-mail: [support.tr@tp-link.com](mailto:support.tr@tp-link.com)  
 Service time: 09:00 to 21:00, 7 days a week

#### Ukraine

Tel: 0800 505 508  
 Fee: Free for Landline; Mobile: Depending on rate of different carriers  
 E-mail: [support.ua@tp-link.com](mailto:support.ua@tp-link.com)  
 Service time: Monday to Friday, 10:00 to 22:00

#### Brazil

Toll Free: 0800 608 9799 (Portuguese Service)  
 E-mail: [suporte.br@tp-link.com](mailto:suporte.br@tp-link.com)  
 Service time: Monday to Friday, 09:00 to 20:00;  
 Saturday, 09:00 to 15:00

#### Indonesia

Tel: (+62) 021 6386 1936  
 Fee: Depending on rate of different carriers.  
 E-mail: [support.id@tp-link.com](mailto:support.id@tp-link.com)  
 Service time: Sunday to Friday, 09:00 to 12:00,  
 13:00 to 18:00 \*Except public holidays

#### Australia/New Zealand

Tel: NZ 0800 87 5465 (Toll Free)  
 AU 1300 87 5465 (Depending on 1300 policy.)  
 E-mail: [support.au@tp-link.com](mailto:support.au@tp-link.com) (Australia)  
[support.nz@tp-link.com](mailto:support.nz@tp-link.com) (New Zealand)  
 Service time: 24hrs, 7 days a week

#### Germany/Austria

Tel: +49 1805 875 465 (German Service)  
 +49 1805 TPLINK  
 +43 820 820 360  
 Fee: Landline from Germany: 0.14EUR/min.  
 Landline from Austria: 0.20EUR/min.  
 E-mail: [support.de@tp-link.com](mailto:support.de@tp-link.com)  
 Service time: Monday to Friday, 09:00 to 12:30  
 and 13:30 to 18:00. GMT+1 or GMT+2 (DST in Germany)  
 \*Except bank holidays in Hesse

#### Singapore

Tel: +65 6284 0493  
 Fee: Depending on rate of different carriers.  
 E-mail: [support.sg@tp-link.com](mailto:support.sg@tp-link.com)  
 Service time: 24hrs, 7 days a week

#### UK

Tel: +44 (0) 845 147 0017  
 Fee: Landline: 1p-10.5p/min, depending on the time of day. Mobile: 15p-40p/min, depending on your mobile network.  
 E-mail: [support.uk@tp-link.com](mailto:support.uk@tp-link.com)  
 Service time: 24hrs, 7 days a week

#### Italy

Tel: +39 (02) 92392214  
 Fee: Depending on rate of different carriers.  
 E-mail: [support.it@tp-link.com](mailto:support.it@tp-link.com)  
 Service time: Monday to Friday, 09:00 to 13:00;  
 14:00 to 18:00

#### Malaysia

Toll Free: 1300 88 875 465  
 Email: [support.my@tp-link.com](mailto:support.my@tp-link.com)  
 Service time: 24hrs, 7 days a week

#### Poland

Tel: +48 (0) 801 080 618  
 +48 223 606 363 (if calls from mobile phone)  
 Fee: Depending on rate of different carriers.  
 E-mail: [support.pl@tp-link.com](mailto:support.pl@tp-link.com)  
 Service time: Monday to Friday, 09:00 to 17:00.  
 GMT+1 or GMT+2 (DST)

#### France

Tel: 0820 800 860 (French service)  
 Fee: 0.118 EUR/min from France  
 Email: [support.fr@tp-link.com](mailto:support.fr@tp-link.com)  
 Service time: Monday to Friday, 09:00 to 18:00  
 \*Except French Bank holidays

#### Switzerland

Tel: +41 (0) 848 800 998 (German Service)  
 Fee: 4-8 Rp/min, depending on rate of different time.  
 E-mail: [support.ch@tp-link.com](mailto:support.ch@tp-link.com)  
 Service time: Monday to Friday, 09:00 to 12:30  
 and 13:30 to 18:00. GMT+1 or GMT+2 (DST)

#### Russian Federation

Tel: 8 (499) 754 5560 (Moscow NO.)  
 8 (800) 250 5560 (Toll-free within RF)  
 E-mail: [support.ru@tp-link.com](mailto:support.ru@tp-link.com)  
 Service time: From 09:00 to 21:00 (Moscow time)  
 \*Except weekends and holidays in RF