



User Guide

4G LTE Broadband Router with Voice

©2013 Novatel Wireless, Inc. All rights reserved. The information contained in this document is subject to change without notice and should not be construed as a commitment by Novatel Wireless, Inc.

Patents and Licenses

Visit www.novatelwireless.com/patents for a complete list of all Novatel Wireless patents.

Software License

Proprietary Rights Provisions:

The software drivers provided with this product are copyrighted by Novatel Wireless and/or Novatel Wireless' suppliers. Although copyrighted, the software drivers are unpublished and embody valuable trade secrets proprietary to Novatel Wireless and/or Novatel Wireless' suppliers. The disassembly, decompilation, and/or Reverse Engineering of the software drivers for any purpose is strictly prohibited by international law. The copying of the software drivers, except for a reasonable number of back-up copies is strictly prohibited by international law. It is forbidden by international law to provide access to the software drivers to any person for any purpose other than processing the internal data for the intended use of the software drivers.

U.S. Government Restricted Rights Clause:

The software drivers are classified as "Commercial Computing device Software" and the U.S. Government is acquiring only "Restricted Rights" in the software drivers and their Documentation.

U.S. Government Export Administration Act Compliance Clause:

It is forbidden by US law to export, license or otherwise transfer the software drivers or Derivative Works to any country where such transfer is prohibited by the United States Export Administration Act, or any successor legislation, or in violation of the laws of any other country.

Trademarks and Service Marks

Novatel Wireless is a trademark of Novatel Wireless, Inc., and the other trademarks, logos, and service marks (collectively the "Trademarks") used in this user manual are the property of Novatel Wireless or their respective owners. Nothing contained in this user manual should be construed as granting by implication, estoppel, or otherwise, a license or right of use of Novatel Wireless or any other Trademark displayed in this user manual without the written permission of Novatel Wireless or its respective owners.

- Novatel Wireless, and the Novatel Wireless logo are all trademarks of Novatel Wireless, Inc.
- MiFi® and the MiFi logo are registered trademarks of Novatel Wireless, Inc.
- Microsoft and Windows are either registered trademarks or trademarks of Microsoft Corporation in the United States and/or other countries.
- Apple®, Mac®, and Mac OS® are trademarks of Apple, Inc., registered in the U.S. and other countries.
- Linux® is the registered trademark of Linus Torvalds in the U.S. and other countries.

The names of actual companies and products mentioned in this user manual may be the trademarks of their respective owners.

Novatel Wireless Revision History

Part Number	Revision	Description	Date
90026844	R1	Initial release	24 Sep 2013

FCC ID: PKRNVW

PN: 90026844_R1_UG_OvationT1114_VZW

Please visit www.novatelwireless.com for the latest information about your device.

Contents

Getting Started	1
Overview.....	2
System Requirements.....	2
Components and Indicators.....	3
Status Indicators.....	6
Power Management.....	8
Caring for Your Router	9
Using the 4G LTE Broadband Router with Voice	10
Accessing the Network	11
Inserting and Charging the Battery.....	13
Removing the Battery.....	13
Backup Battery Tips.....	14
Installing the Optional Antenna	15
Powering On and Off	17
Powering On	17
Powering Off	17
Connecting Your Telephone.....	17
Initial Activation	18
Using Your Telephone After Initial Activation.....	19
Making Calls.....	19
Receiving Calls	19
Voice Mail	19
Call Forwarding.....	20
10-Digit Dialing.....	20
Home Security Systems	20
Other Incompatibilities	20
Connecting to Your Router.....	21
Connecting Wi-Fi Devices	21
Connecting Wired/Ethernet Devices.....	23
Using Your Router After Setup.....	24
Using the 4G LTE Broadband Router with Voice Display	28
4G LTE Broadband Router with Voice Settings	29
Managing Your Router	30
On the 4G LTE Broadband Router with Voice Display	30
On the 4G LTE Broadband Router with Voice Web User Interface.....	31
Sign In	32
Sign In	32
Menu Panel.....	33
Home	34
On the 4G LTE Broadband Router with Voice Display	34

On the 4G LTE Broadband Router with Voice Web User Interface.....	35
Manage My Broadband Router with Voice	36
My Account & Tools.....	38
Help & Support	39
Data Usage.....	40
On the 4G LTE Broadband Router with Voice Display	40
On the 4G LTE Broadband Router with Voice Web User Interface.....	41
Wi-Fi Name/Password.....	42
On the 4G LTE Broadband Router with Voice Display	42
Connected Devices	43
On the 4G LTE Broadband Router with Voice Display	43
On the 4G LTE Broadband Router with Voice Web User Interface.....	44
Connected Devices	45
Blocked Devices	48
Voice Signal	50
On the 4G LTE Broadband Router with Voice Display	50
On the 4G LTE Broadband Router with Voice Web User Interface.....	50
Data Signal.....	51
On the 4G LTE Broadband Router with Voice Display	51
On the 4G LTE Broadband Router with Voice Web User Interface.....	51
Battery	52
On the 4G LTE Broadband Router with Voice Display	52
On the 4G LTE Broadband Router with Voice Web User Interface.....	52
Settings.....	53
On the 4G LTE Broadband Router with Voice Display	53
Wi-Fi	56
Voice.....	59
Device	62
Advanced	66
About.....	76
On the 4G LTE Broadband Router with Voice Display	76
On the 4G LTE Broadband Router with Voice Web User Interface.....	77
Internet Status.....	77
Device Info	79
Diagnostics.....	80
Logs.....	84
Customer Support.....	86
Troubleshooting.....	88
Overview.....	89
Common Problems and Solutions.....	90
Technical Support	93
Technical Support	93

Product Specifications and Regulatory Information	94
Product Specifications	95
General	95
Technology/Bands.....	95
Environmental.....	95
Regulatory Information	96
Wireless Communications.....	97
Limited Warranty and Liability	98
Safety Hazards.....	99
Proper Battery Use and Disposal	101
Glossary.....	102

1

Getting Started

Overview
Components and Indicators
Power Management
Caring for Your RouterRouter

Overview

The 4G LTE Broadband Router with Voice is a wireless router that delivers Internet connectivity and telephone service. You can make a phone call and simultaneously provide network and Internet connectivity for up to 10 devices via Wi-Fi and up to 3 devices via Ethernet. Connect laptops, tablets, e-readers, gaming consoles and more. **

System Requirements

- Compatible with all major operating systems.
- Works with the latest versions of browsers, including Android™, Google Chrome®, Firefox®, Internet Explorer®, Safari® and Mobile Safari™.

To use Wi-Fi mode, your computer needs Wi-Fi capability. If your computer does not have Wi-Fi capability you can use Ethernet.

Your 4G LTE Broadband Router with Voice must have a voice and/or data plan to function properly. You must subscribe to an eligible Verizon Wireless Voice Only, Data Only or Voice and Data plan. (See [Getting Started](#) on page 12.)

* When multiple users are connected to the 4G LTE Broadband Router with Voice, all of their data usage will be aggregated and applied to the Verizon Wireless customer's data allowance. A voice plan is not required to make E911 calls, but an external telephone must be connected to the router.

Components and Indicators



- ① **Power on/off button** — powers the router on and off.
- ② **Internet indicator** — displays internet availability.
- ③ **Wi-Fi indicator** — displays status of Wi-Fi connections to the router.
- ④ **LAN indicator** — displays status of Ethernet connections to the router.
- ⑤ **WPS button** — allows devices to connect to the router using WPS and displays WPS connection status.
- ⑥ **OLED display** — displays connected devices, messages, network connection information, and menu options.
- ⑦ **Scroll left/right** — use to scroll and select the desired menu option.
- ⑧ **Select button** — use to select a menu option.
- ⑨ **Network indicators** — displays data and voice signal strength, network activity and roaming status.
- ⑩ **Status bar** — displays number of devices connected to the router via Wi-Fi and number of new voice mail messages.



- ① **Optional antenna* port 1** — optional antenna connection port
- ② **Optional antenna* port 2** — optional antenna connection port
- ③ **Phone port 1** — phone connector port
- ④ **Phone port 2** — phone connector port
- ⑤ **Home Security port**** — Home Security connector port

WARNING! Do not connect telephone, fax or any other devices to the yellow port labeled **ALARM**. Doing so may cause the telephone to stop working.









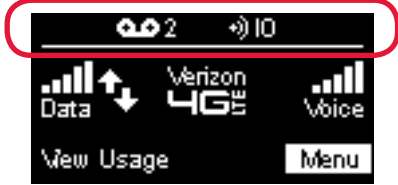

- ⑥ **Ethernet port 1** — Local Area Network (LAN) connector port
- ⑦ **Ethernet port 2** — Local Area Network (LAN) connector port
- ⑧ **Ethernet port 3** — Local Area Network (LAN) connector port
- ⑨ **Power port** — AC power connector port
- ⑩ **Battery cover** — remove to access battery (not shown - on bottom of router)







* Sold separately ** Future feature

Indicator States

INDICATOR	LED	DESCRIPTION
All	Unlit	The 4G LTE Broadband Router with Voice is powered off or not receiving power, or the screen is in power-saving mode
Power button	Blue solid	Normal operation
	Blue blinking	Battery is in Low Power Mode (LPM)
	Red solid	No AC power. Router operating on battery - only voice service is available
Internet indicator	Red solid	Indicates Internet connectivity
	Unlit	Indicates no Internet connectivity
Wi-Fi indicator	Blue solid	Wi-Fi user(s) connected but not sending or receiving data
	Blue blinking	Wi-Fi user(s) connected and sending or receiving data
	Unlit	No user(s) connected via Wi-Fi
LAN indicator	Blue solid	User(s) connected via Ethernet but not sending or receiving data
	Blue blinking	User(s) connected via Ethernet and sending or receiving data
	Unlit	No user(s) connected via Ethernet
WPS button	Amber blinking	Searching for wireless devices to connect via WPS. You have two minutes to start WPS on the wireless device you want to connect to the router
	Green solid	WPS connection successful
	Red blinking	Router could not find a wireless device. Try again to establish a WPS connection

Status Indicators

DISPLAY ICON	DESCRIPTION
No icons	The 4G LTE Broadband Router with Voice is powered off, or the screen is in power-saving mode
Status Bar 	
Connected devices	 Indicates the number of devices connected to the router via Wi-Fi
Messages	 Indicates that a new voice mail message has been received
Network 	
Data signal strength* indicator	 Displays signal strength for the data network - one to five bars
Network activity indicator	 Displays when data is being transferred between your 4G LTE Broadband Router with Voice and the network
Voice signal strength* indicator	 Displays the signal strength for the voice network - from one to five bars
Network roaming indicator	 Displays when the router is roaming and is connected to a network other than the Verizon network
Menu 	
Connected devices	 Scroll and select this icon to display the number and IP address of connected devices

Software update		Scroll and select this icon to display the current software version, date and time of last check for updates and to check for current software updates
About		Scroll and select this icon to display the mobile number, model number, IMEI, URL and Admin Password for your 4G LTE Broadband Router with Voice
Home		Scroll and select this icon to return to the 4G LTE Broadband Router with Voice main display screen
Data Usage*		Scroll and select this icon to view the amount of data used in the current billing period
Battery		More white on the battery indicates more battery life
Wi-Fi Name/Password		Scroll and select this icon to display the Wi-Fi name (SSID), password and web interface URL

* Available to customers who subscribe to an eligible data plan.

Power Management

Your 4G LTE Broadband Router with Voice will provide both voice and data service when plugged into an AC power source. **When disconnected from AC power and operating on backup battery power, only voice service will be available.***

- **Backup Battery** — Charge the backup battery by plugging the router into AC power. When the battery is fully charged, the battery icon on the display carousel is solid. If only battery power is being used, data service is not available.
- **AC Wall charger** — You can use the router when the battery is installed and the charger is plugged into a wall outlet. Please ensure the wall outlet is located near the router and is easily accessible. The backup 4G LTE Broadband Router with Voice battery charges while the router power cord is plugged into an AC outlet.

Before using the 4G LTE Broadband Router with Voice, read the battery safety information in the "Safety Hazards" section of this guide. (See [Proper Battery Use and Disposal](#) on page 101.)

* Voice and data availability dependent upon the selected Verizon service plan. A phone that does not require separate electric power to operate is required to place or receive calls (including 911) during a power outage.

Caring for Your Router

Like any electronic product, the 4G LTE Broadband Router with Voice must be handled with care to ensure reliable operation. The following guidelines are recommended:

- Protect the router from liquids, dust, and excessive temperatures.
- Do not apply adhesive labels to the router as they may cause the router to potentially overheat or alter the performance of the antenna.
- Store the router in dry and secure location when not in use.

Using the 4G LTE Broadband Router with Voice

Accessing the Network
Getting Started
Connecting to Your Router
Using Your Router After Setup

Accessing the Network

4G LTE

With 4G LTE bandwidth (700 MHz) you can get the broadband speed you require for Internet connectivity for your home, small office or even a vacation destination. You can connect to the Internet, access your corporate intranet, check your email and download attachments at speeds that are up to 10 times faster than 3G*.

4G Mobile Broadband with LTE*

- Download: typical download speeds of 5-12 Mbps.
- Upload: typical upload speeds of 2-5 Mbps.

Wi-Fi 802.11a/b/g/n

- 802.11a uses the 5.0 GHz peak data rate with a bandwidth of 54 Mbps.
- 802.11b uses the 2.4 GHz peak data rate with a bandwidth of 11 Mbps.
- 802.11g uses the 2.4 GHz peak data rate with a bandwidth of 54 Mbps.
- 802.11n uses the 2.4 GHz or 5.0 GHz peak data rate with a bandwidth of 150 Mbps.

* Speeds shown are those published by Verizon Wireless, Inc. Actual throughput speed and coverage may vary.

Getting Started

To set up and use your 4G LTE Broadband Router with Voice for the first time:

- ① Confirm your computer meets the minimum system requirements. (See [System Requirements](#) on page 2.)
- ② Insert and charge the battery. (See [Inserting and Charging the Battery](#) on page 13.)
- ③ Install the optional antenna, if desired. (See [Installing the Optional Antenna](#) on page 15.)
- ④ Plug in the power adapter. (See [Powering On and Off](#) on page 17.)
- ⑤ Connect your telephone(s). (See [Connecting Your Telephone](#) on page 17.)
- ⑥ Make a test voice call. (See [Making Calls](#) on page 19.)*
- ⑦ Set up your voice mail account. (See [Voice Mail](#) on page 19.)*
- ⑧ Connect your computer or other Wi-Fi enabled devices to the router using Wi-Fi. (See [Connecting to Your Router](#) on page 21.)**
- ⑨ Connect up to three devices via Ethernet. (See [Connecting Wired/Ethernet Devices](#) on page 23.)**

* Not applicable to Data plan only subscribers.

** Not applicable to Voice only subscribers.

Inserting and Charging the Battery

- 1 Press your finger against the battery cover removal tab on the underside of the router, then lift and remove the cover.
- 2 Plug in and insert the battery, keeping the red cable to the center of the router and the metal contacts facing up.



- 3 Replace the battery cover by setting it on the router where the notches align, then press on the cover until it clicks into place and is flat across the entire bottom surface.
- 4 Plug the AC power cord into the router power port on the back of the router.
- 5 Plug the other end of the power cord into an appropriate electrical outlet.

CAUTION! Use only batteries and chargers with your 4G LTE Broadband Router with Voice that have been approved by Verizon Wireless. Failure to use approved batteries and chargers may increase the risk that your router will overheat, catch fire, or explode, resulting in serious bodily injury, death, or property damage.

Removing the Battery

- 1 Power off and unplug the router if applicable.
- 2 Press your finger against the battery cover removal tab on the underside of the router, then lift and remove the cover.
- 3 Lift the battery to remove from the battery compartment.
- 4 Carefully disconnect the battery cable from the battery plug.

IMPORTANT Whenever you remove or insert the battery, ensure your 4G LTE Broadband Router with Voice is not connected to any device or power source. Never use tools, knives, keys, pens or any type of object to force the battery cover open or to remove the battery. Using any of these types of objects could result in puncturing the battery.

Backup Battery Tips

WARNING! Always use approved batteries and chargers with your 4G LTE Broadband Router with Voice. The warranty does not cover damage caused by non-approved batteries and/or chargers.

- It normally takes 2.5 to 3 hours to fully charge the backup battery with the power cord.
- Do not use sharp objects or excessive force or remove the battery, as this may damage the router and the battery.
- Battery life depends on the network, signal strength, temperature, features, and accessories you use.
- New batteries or batteries stored for a long time may take more time to charge.
- When charging your battery, keep it near room temperature.
- When storing your battery, keep it uncharged in a cool, dark, dry place.
- Never expose batteries to temperatures below -20°C (4°F) or above 60°C (140°F).
- Never leave the router in an unattended vehicle due to uncontrollable temperatures that may be outside the desired temperature range for this router.
- Some batteries perform best after several full charge/discharge cycles.
- It is normal for batteries to gradually wear down and require longer charging times. If you notice a change in your battery life, it is probably time to purchase a new battery.

Installing the Optional Antenna

To purchase the optional ProBrand 4G LTE Signal Booster Antenna (PROB4GANT) for the 4G LTE Broadband Router with Voice, please visit www.verizonwireless.com or go to a Verizon Wireless store.

IMPORTANT INSTRUCTIONS Read before installation.

If using the optional antenna, align the antenna with the antenna port on the 4G LTE Broadband Router with Voice and attach securely into place.

Use the following installation instructions to comply with FCC rules on RF exposure. Failure to follow these guidelines can result in operations that exceed RF exposure limits.

- Maintain a minimum distance of at least 20 cm (8 in) from all persons regardless of how the antenna is mounted (stand assembly or wall mount).
- Connect the antenna to the router using the supplied cable only – do not use a different cable. Use the full length of the cable to position the antenna as far from the router and generally populated areas as possible.

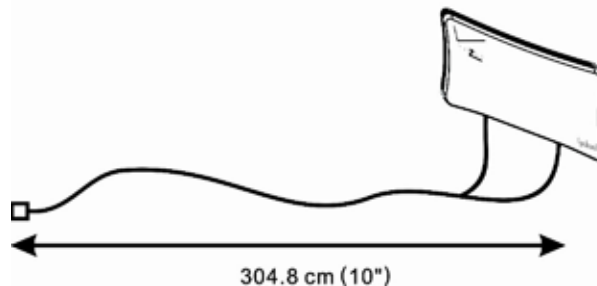

- For wall mount installations, position the antenna as far off the ground as possible ensuring at least 20 cm (8 in) from people.

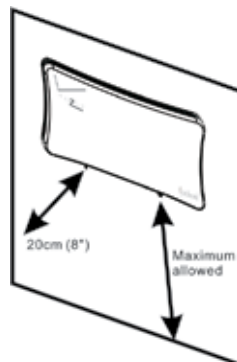

- For stand assembly installations, maintain a minimum distance of 20 cm (8 in) between the antenna and people at all times.

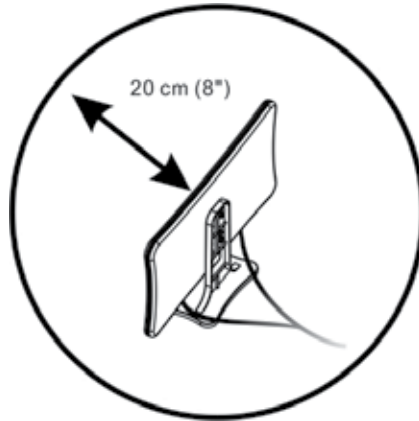

- Do not operate the 4G LTE Broadband Router with Voice and the antenna within 5 cm (2 in) of each other.

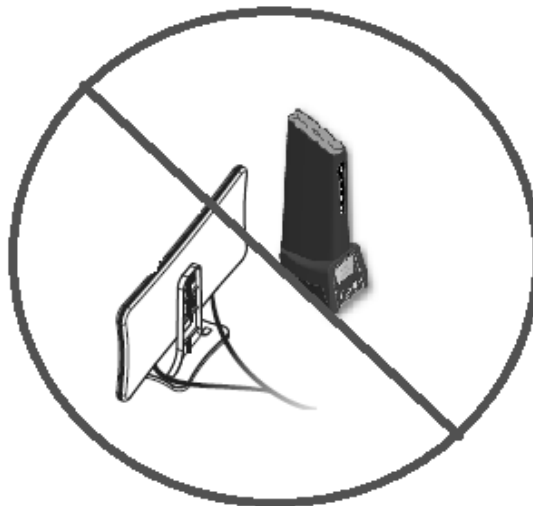

- Use only the approved ProBrand 4G LTE Signal Booster Antenna (PROB4GANT) available through Verizon Wireless. Never use an antenna from another vendor or another source.

Powering On and Off

Powering On

- 1 Plug the power cord into the router power port.
- 2 Plug the power adapter into an AC wall outlet. The router will power on automatically, and guide you through a welcome process for connecting via Wi-Fi. When complete, ensure at least one bar of the voice signal strength indicator () is lit. If not, move the router to an alternative location that provides a stronger signal.

WARNING! Be sure to use the power cord that came with your router to avoid damage that may void the warranty.

NOTE If the router is disconnected from AC power and running on the battery alone, only voice calls are supported. A phone that does not require separate electric power to operate is required to place or receive calls (including 911) during a power outage.

Powering Off

- 1 Press and hold the Power button until the display shows **Verizon Powering Off**. If the battery is not fully charged, the router will begin operating in Charging Mode, and the screen will display the battery charging indicator (). When the battery is fully charged, the router will power off completely.
- 2 To restart normal operation, press and hold the Power button until the display shows **MiFi® Powered**.

Connecting Your Telephone

The 4G LTE Broadband Router with Voice provides ports for up to two telephones. Both ports use the same telephone number.

- 1 Unplug your telephone's cord from your wall's telephone jack.

WARNING! Do NOT plug the 4G LTE Broadband Router with Voice into your telephone wall jack.



- 2 Plug the end of the telephone cord that was just removed from the wall jack into one of the two phone ports on the back of the router. The other end of the cord must remain plugged into the back of your telephone's base unit.

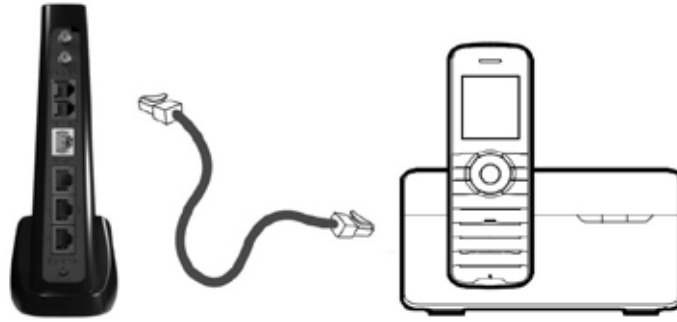

NOTE If the router is disconnected from AC power and running on the battery alone, only voice calls are supported. A phone that does not require separate electric power to operate is required to place or receive calls (including 911) during a power outage.

Initial Activation

Transferring Your Existing Number

IMPORTANT Customers transferring a phone number will not be able to receive calls on the 4G LTE Broadband Wireless Router with Voice until the transfer process is complete. This process can take 2–10 business days and you will receive an email to the email address you provided when your transfer is complete.

Once the transfer is complete, disconnect the phones attached to your home wall jacks. Connect your phone(s) to the 4G LTE Broadband Router with Voice and power on. You will now be able to make and receive calls through the phones connected to the router.

To check the status of your transfer, visit www.verizonwireless.com/lnp or call the Port Center at (877) 567-4899.

Activating a New Number

Your router automatically activates the new number after the router is powered on, as long as network coverage is available. Make a call to test service.

To display your new phone number:

- Select **Menu** and open the **About** option. The initial About screen displays your new mobile phone number, the 4G LTE Broadband Router with Voice model, and the IMEI number.

NOTE A voice plan is required to make and receive calls. Your 4G LTE Broadband Router with Voice will require 10-digit dialing in most areas. Customers will typically need to use the three-digit Area Code when dialing local and long distance numbers. If you are not subscribed to a plan with voice service and would like to add this feature, dial *611 to sign up for service.

Using Your Telephone After Initial Activation

Making Calls

Before making a call, make sure at least one of the voice signal strength indicators is lit.

- ① Place a call by entering the desired telephone number, including area code.
- ② When your call is complete, hang up or return the phone to the receiver to ensure that you can receive calls.

Receiving Calls

- For customers with a new telephone number, simply share your new number with friends and family. When they call, answer the phone connected to your 4G LTE Broadband Router with Voice.
- For customers that are transferring their current home number to the 4G LTE Broadband Router with Voice, do not disconnect your existing home phone from the wall jack during the transfer process.
- Incoming calls will continue to ring on your existing home phone until the transfer is complete.

Voice Mail

Setting up Voice Mail

To set up and manage your voice mail, dial *86 and follow the system prompts. For more details about your voice mail service, visit www.verizonwireless.com/voicemail.

Using Voice Mail

- ① The voice mail indicator () and number of voice messages not yet listened to will appear on the status bar of the 4G LTE Broadband Router with Voice display.
- ② Dial *86 to access your voice mail.
- ③ Follow the system prompts to listen to and manage your voice mails.

NOTE Refer to the Troubleshooting section for additional instruction on accessing voice mail or using a home telephone answering machine as your preferred method to manage your voice messages.

Call Forwarding

Verizon 4G LTE Broadband Router with Voice allows customers to forward calls to another phone number, including your mobile phone or office number. Your home phone will not ring until you turn off the service. Airtime applies to forwarded calls even if you send the call to landline telephones.

To Turn on Call Forwarding

- ① Dial *72.
- ② Immediately enter the phone number where you want calls forwarded (for example, *72-212-123-4567).
- ③ You will hear a confirmation tone.
- ④ Hang up your home phone or return the phone receiver to its base.

To Turn off Call Forwarding

- ① Dial *73.
- ② You will hear a confirmation tone.
- ③ Hang up your home phone or return the phone receiver to its base.

10-Digit Dialing

Your Verizon 4G LTE Broadband Router with Voice will require 10-digit dialing in most areas, requiring Customers to use the three-digit Area Code when dialing local and long distance numbers.

Home Security Systems

Your Verizon 4G LTE Broadband Router with Voice does not support Home Security systems at this time. Please check with your Home Security system provider to confirm the compatibility requirements of your Home Security system.

Other Incompatibilities

- Making or receiving collect, 500, 700, 900, 976, operator-assisted or dial-around (e.g., 1010-XXXX) calls
- DSL or dial up Internet service
- DVR, Dish Network, and DirecTV
- Mobile merchant machines (credit card machines)
- Any type of PBX or Centrex system
- Medical or Life Alert dependencies

Connecting to Your Router

Connecting Wi-Fi Devices

You can connect to your 4G LTE Broadband Router with Voice with your computer, tablet or other Wireless devices that have Wi-Fi and Internet browser software. Your 4G LTE Broadband Router with Voice is compatible with all major operating systems, and works with the latest version of browsers, including Android, Google, Chrome, Firefox, Internet Explorer, Safari and Mobile Safari. Your default Wi-Fi Name (SSID) and Password can be found on the router display upon initial power up.

To access your Wi-Fi Name (SSID) and Password after the initial power up or a router reset:

- 1 Power on your 4G LTE Broadband Router with Voice.
- 2 Select **Menu** and open the Wi-Fi Name and Password option.
- 3 Select **Open** to display the Wi-Fi Name/Password.

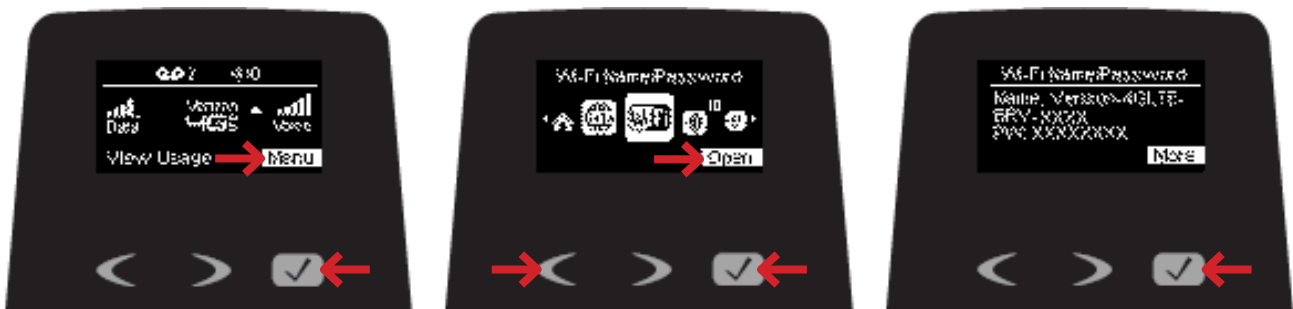

To connect to your router:

- 1 Turn on your Wi-Fi capable device and connect your 4G LTE Broadband Router with Voice to AC power. The router display will light up and broadcast its own wireless network and name.
- 2 Open the Wi-Fi application or controls on the computer or Wi-Fi capable device that you want to connect to your router and find the Wi-Fi name (SSID).

Tip!

The steps to connect to a Wi-Fi network vary depending on your operating system and whether you use the native application or third-party software. Generally, with a PC you click an icon in the Windows notification area where you can select **View Available Wireless Networks**, or click the Airport icon in the menu bar on a Mac® computer. If you are unfamiliar with wireless networking on your computer, consult the computer's help system.

- 3 When prompted, enter your Password, which can be found on the router display by pressing the **Select** button (Menu) on the Home screen to display the Wi-Fi icon, then pressing the **Select** button (Open) to display the Wi-Fi Name/Password screen. The router display should now show an additional connected device. Your Wi-Fi capable device is now connected to the Internet.

You can view or change 4G LTE Broadband Router with Voice settings by connecting to the router's web user interface at <http://VerizonBRV> or <http://192.168.1.1>.

To find the Web User Interface URL and Admin Password on the 4G LTE Broadband Router with Voice's display:

- 1 From the Home screen, select **Menu** to display the Menu options.
- 2 Scroll to **About** and select **Open > More** to display the web interface URL and Admin Password.



IMPORTANT Charge the battery completely before you connect your computer to your 4G LTE Broadband Router with Voice. (See [Inserting and Charging the Battery](#) on page 13.)

Connecting Wired/Ethernet Devices

You can connect up to three wired devices such as laptops, printers and gaming consoles via Ethernet.



- 1 Plug the end of an Ethernet cable into one of the three Ethernet ports.
- 2 The other end of the cable must remain plugged into the Ethernet port of the device you wish to connect.

NOTE The Ethernet cables are sold separately.

Using Your Router After Setup

You can use the 4G LTE Broadband Router with Voice to connect up to a total of 10 Wi-Fi capable devices and three devices connected via Ethernet simultaneously to the mobile broadband network. The router is powered on as soon as you plug it into AC power.

The 4G LTE Broadband Router with Voice comes from the factory with security settings turned on. You can change the security settings using the Web User Interface.

To change your security settings:

- 1 Open the web browser of a device connected to the 4G LTE Broadband Router with Voice and enter **http://VerizonBRV** or **http://192.168.1.1**.

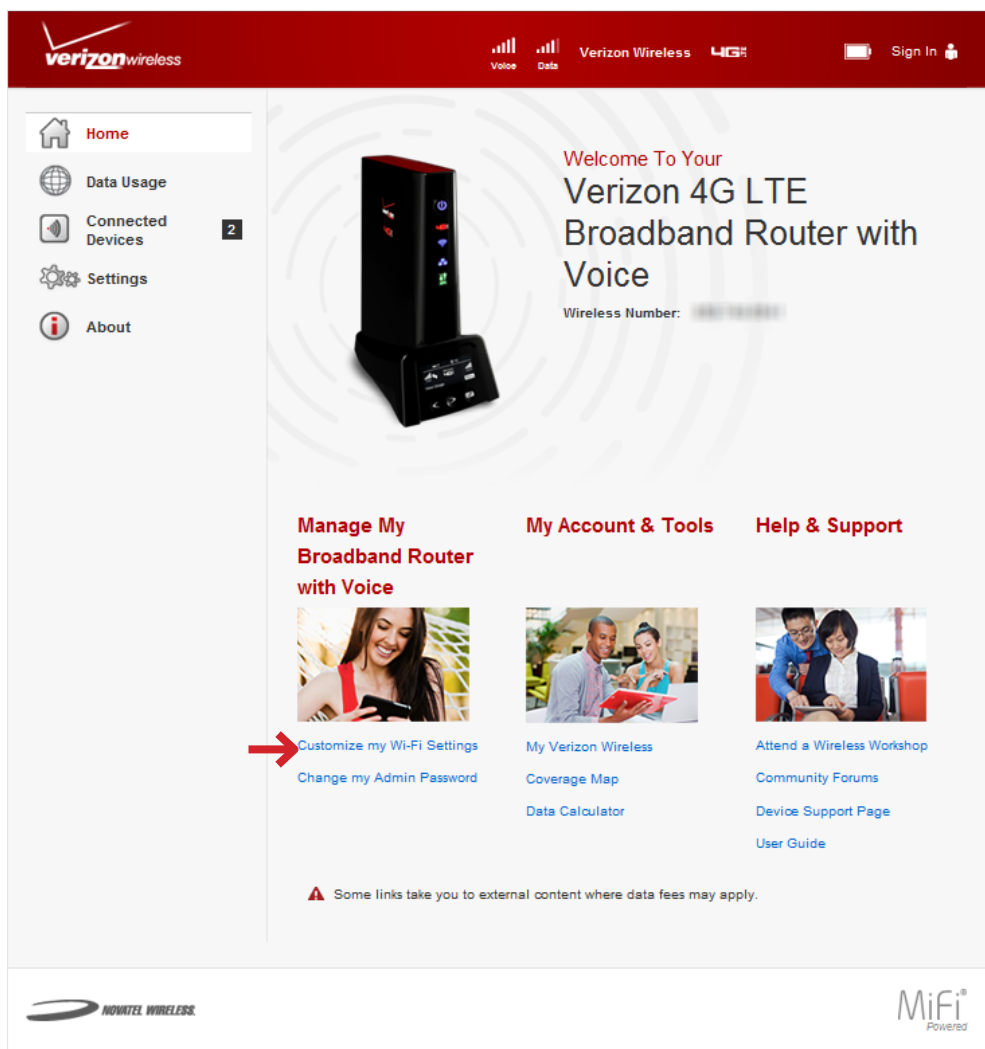

- 2 Sign In with the Admin Password which can be found on the router display by selecting **Menu > Wi-Fi Name/Password > Open > More > More**.
- 3 To change your Wi-Fi Name/Password, from the Web Interface Home page, select **Manage My 4G LTE Broadband Router with Voice > Customize my Wi-Fi Settings**. By default, your Wi-Fi and Admin Passwords are the same.

- 4 Enter the new Wi-Fi Name in the Wi-Fi name field and the new Wi-Fi Password in the Wi-Fi password field.
- 5 Click **Save Changes**.

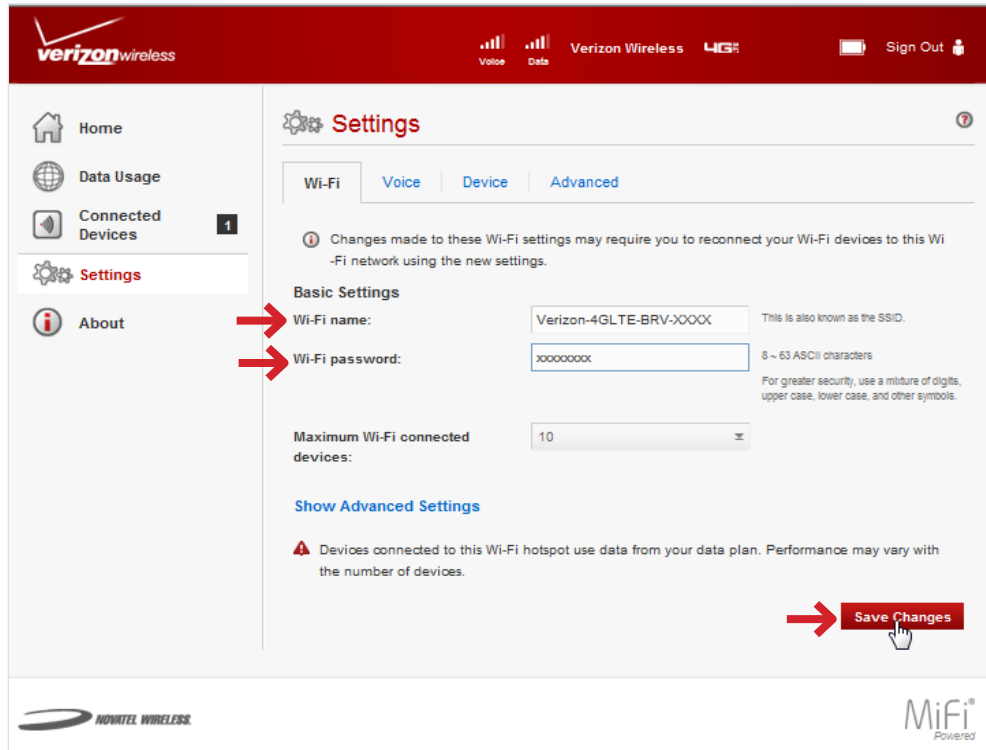

- 6 To change your Admin Password from the Web User Interface Home page, select **Manage My Broadband Router with Voice > Change my Admin Password**.

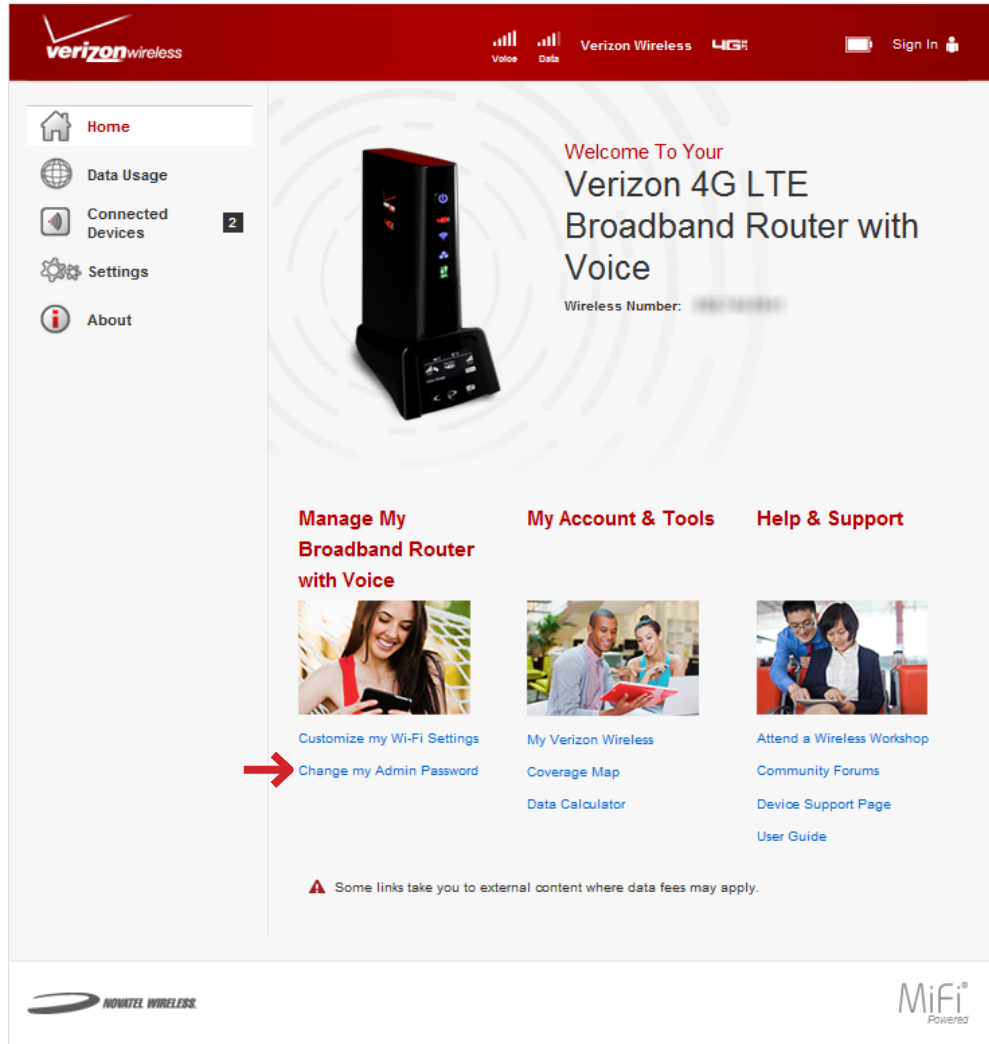

- 7 Enter your current Admin Password in the Enter current password field.
- 8 Enter your new Admin Password in the Enter new password field, and re-enter to confirm in the Confirm new Admin password field.



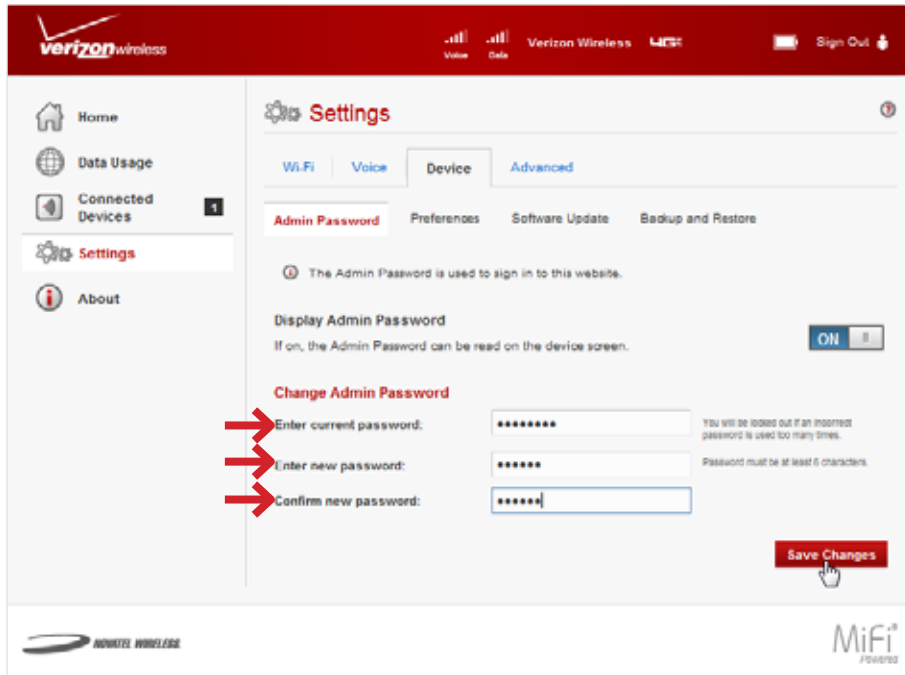

9 Click **Save Changes**.



Using the 4G LTE Broadband Router with Voice Display

From the 4G LTE Broadband Router with Voice user display, you can check your device status, view your current data usage, and access icon-based menu options if you subscribe to an eligible data only or voice and data plan by using the Scroll and Select buttons. (See Components and Indicators on page 3).

To view the current status of your device:

- 1 Press the power button to display the Home Screen. The status bar is at the top of the screen.
- 2 Check the status indicators for unread voice messages , number of connected devices , network data signal strength , connected network , and network voice signal strength .

To view your current data usage:

- 1 Press the left scroll button to highlight **View Usage**.



- 2 Press the select button. Current data usage in GB and billing cycle schedule displays on the 4G LTE Broadband Router with Voice screen.
- 3 Press the left scroll button to refresh, and press the select button to close and return to the Home screen.

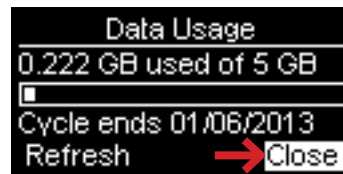
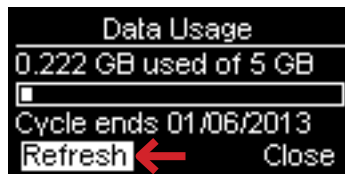

To access the icon-based menu options:

- 1 Press the select button to display the menu icons.
- 2 Use the scroll buttons to move left or right to highlight the desired menu option, then press the select button to open the highlighted option. Continue to press the select button to move through any additional screens.



NOTE

Display turns off after a period of non-use, which can be set to 30 sec, 1 min, 2 min, 5 min or Never using **Settings > Device > Preferences** on the Web User Interface.

4G LTE Broadband Router with Voice Settings

Managing Your Router
Home
Data Usage
Wi-Fi Name/Password
Connected Devices
Voice Signal
Data Signal
Battery
Software Update
Messages
About

Managing Your Router

Manage, monitor, and customize your 4G LTE Broadband Router with Voice settings directly on the router, or by using the Web User Interface.

On the 4G LTE Broadband Router with Voice Display

- 1 Power on your 4G LTE Broadband Router with Voice by plugging the power cord into the router power port, then plugging the power adapter into an AC wall outlet.
- 2 Use the status display to monitor messages, connected devices, network activity, network data and voice strength, and roaming status.
- 3 From the Home screen, press the left scroll button to highlight **View Usage**, then press the select button to display the Data Usage screen with your current data usage and billing cycle schedule.



- 4 Press the select button to close the Data Usage screen and return to the Home screen.
- 5 Press the select button to display the Menu icons.
- 6 Use the scroll buttons to scroll to the desired Menu option.
- 7 Press the select button to open the selected Menu screen.

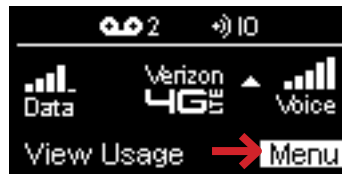
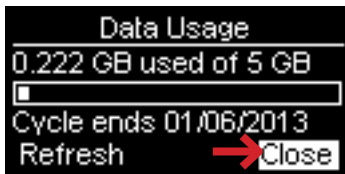

On the 4G LTE Broadband Router with Voice Web User Interface

To connect to the 4G LTE Broadband Router with Voice web interface and customize your router settings:

- 1 Connect your computer or Wi-Fi capable device to your 4G LTE Broadband Router with Voice to access the Internet. (See [Connecting to Your Router](#) on page 21.)

IMPORTANT You can only access the 4G LTE Broadband Router with Voice Web User Interface when you are connected to the router.

- 2 Open your connected device's web browser and type <http://VerizonBRV/> or <http://192.168.1.1> into the address bar. Press **Enter**. The 4G LTE Broadband Router with Voice Home page opens. (See [Sign In](#) on page 32.)

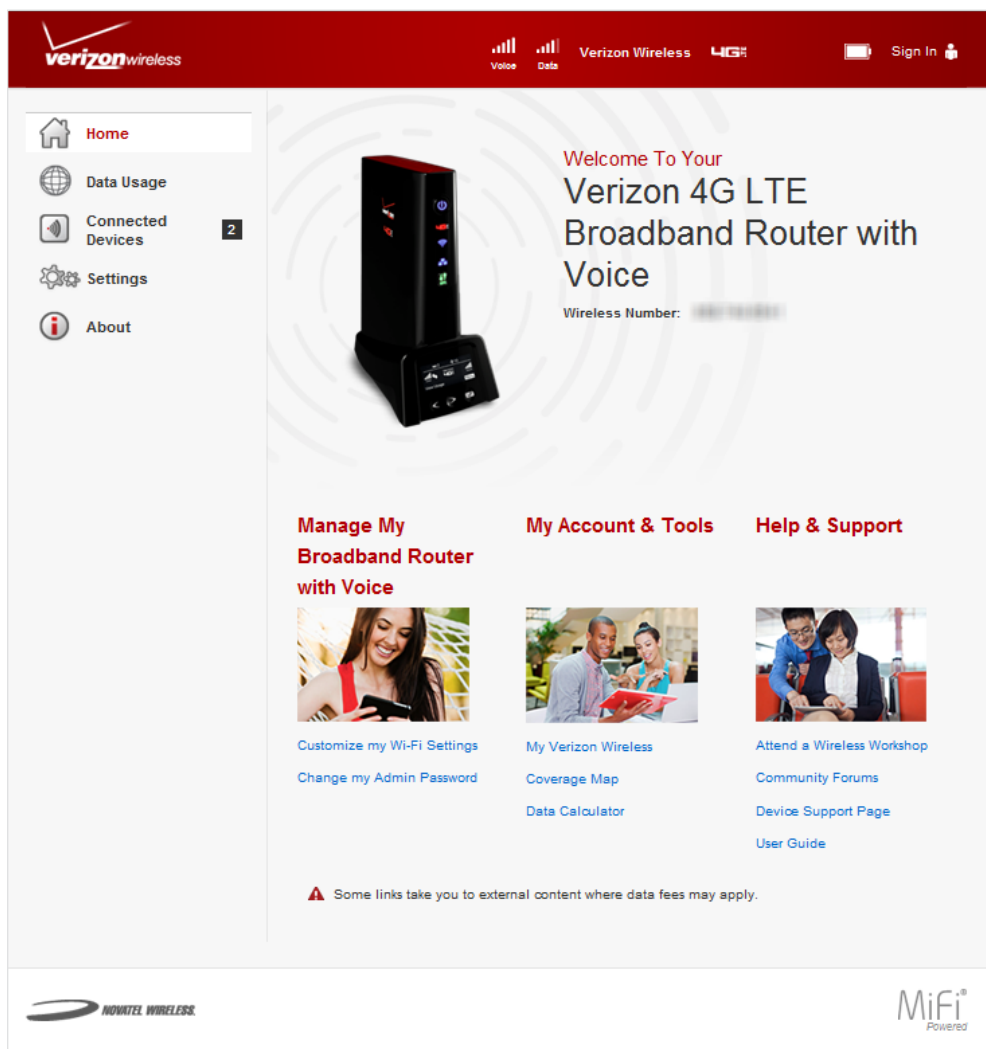

- 3 Click **Sign In** in the upper right corner of the window and type your Admin Password in the **Admin password** field and click **Sign In** to display the Home page. (See [Sign In](#) on page 32.)

You are now able to customize your router settings configuration.

Sign In

The Sign In page is the first page you see after connecting and prior to signing in. You can access more information after you Sign In.

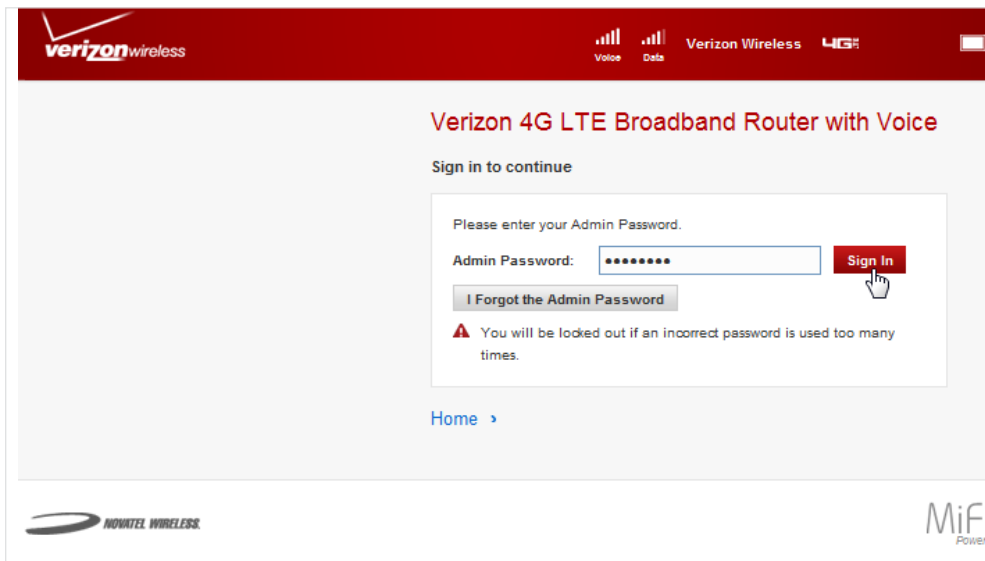

Sign In

Type the Admin Password (the default password is found on the router by scrolling to the **About** icon and selecting **Open > More > More** to display the Admin Password) in the **Sign In** field at the top right corner of the window. Click **Sign In**.

If you forget your Admin Password, click **I Forgot the Admin Password** and a reminder will appear telling you where to find your password. Click **OK**.

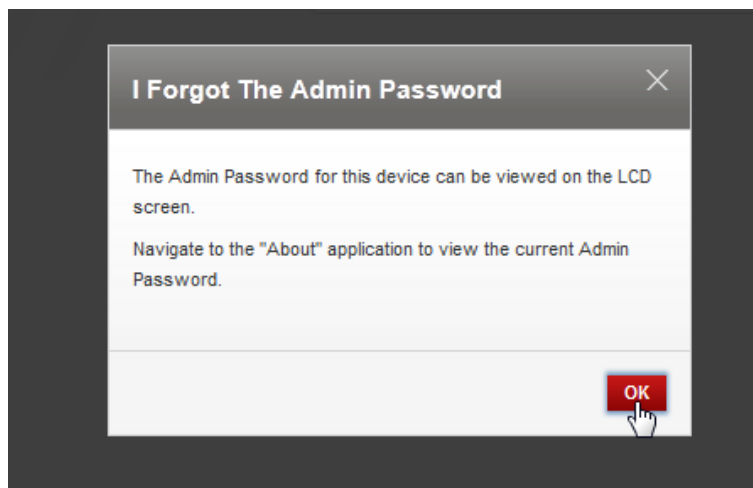

Menu Panel

The Menu Panel is the primary navigation for 4G LTE Broadband Router with Voice Settings. You can access each feature under the appropriate menu.

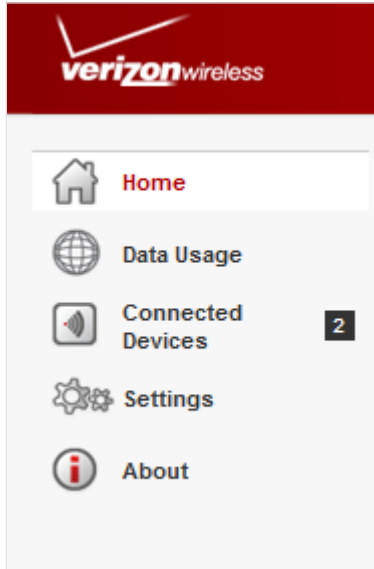

The 4G LTE Broadband Router with Voice Home page is your gateway to configuring and managing your router.

On the 4G LTE Broadband Router with Voice Display

- 1 Power on your 4G LTE Broadband Router with Voice by plugging the power cord into the router power port, then plugging the power adapter into an AC wall outlet.
- 2 Press the select button to display the Menu icons.
- 3 Use the scroll buttons to scroll to the desired Menu option.
- 4 Press the select button to open the selected Menu option.



- 5 To return to the Home screen, press the select button to close the selected Menu option, then scroll to the Home icon and press the select button to Go Home.



On the 4G LTE Broadband Router with Voice Web User Interface

The Home page allows you to quickly access commonly used links and all available menu options for your router. The Home page contains the following quick link menu options:

- **Manage My Broadband Router with Voice** (See [Manage My Broadband Router with Voice](#) on page 36.)
- **My Account & Tools** (See [My Account & Tools](#) on page 38.)
- **Help & Support** (See [Help & Support](#) on page 39.)

The screenshot shows the Verizon 4G LTE Broadband Router with Voice web user interface. The page has a red header with the Verizon Wireless logo on the left and signal strength, voice, data, and 4G LTE indicators on the right. A 'Sign In' button is also present. The main content area features a navigation menu on the left with options: Home, Data Usage, Connected Devices (with a '2' notification), Settings, and About. The central area displays a 'Welcome To Your Verizon 4G LTE Broadband Router with Voice' message, including a 'Wireless Number' field. Below this, there are three main sections: 'Manage My Broadband Router with Voice' (with links for 'Customize my Wi-Fi Settings' and 'Change my Admin Password'), 'My Account & Tools' (with links for 'My Verizon Wireless', 'Coverage Map', and 'Data Calculator'), and 'Help & Support' (with links for 'Attend a Wireless Workshop', 'Community Forums', 'Device Support Page', and 'User Guide'). A warning icon and text at the bottom state: 'Some links take you to external content where data fees may apply.' The footer includes the Intel Wireless logo on the left and the MiFi Powered logo on the right.

Manage My Broadband Router with Voice

The Manage My Broadband Router with Voice menu contains the following options:

- **Customize my Wi-Fi Settings** (See [Customize my Wi-Fi Settings](#) on page 36.)
- **Change my Admin Password** (See [Change my Admin Password](#) on page 37.)

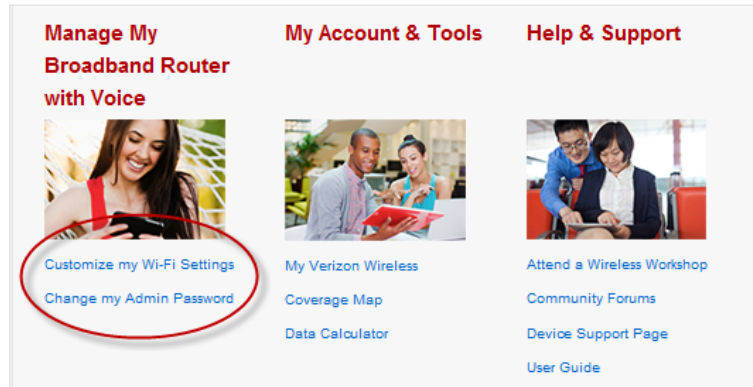

Customize my Wi-Fi Settings

Clicking on **Customize my Wi-Fi Settings** will take you to the Settings page Wi-Fi menu, where you can customize Wi-Fi profiles for your 4G LTE Broadband Router with Voice. (See [Wi-Fi](#) on page 62.)

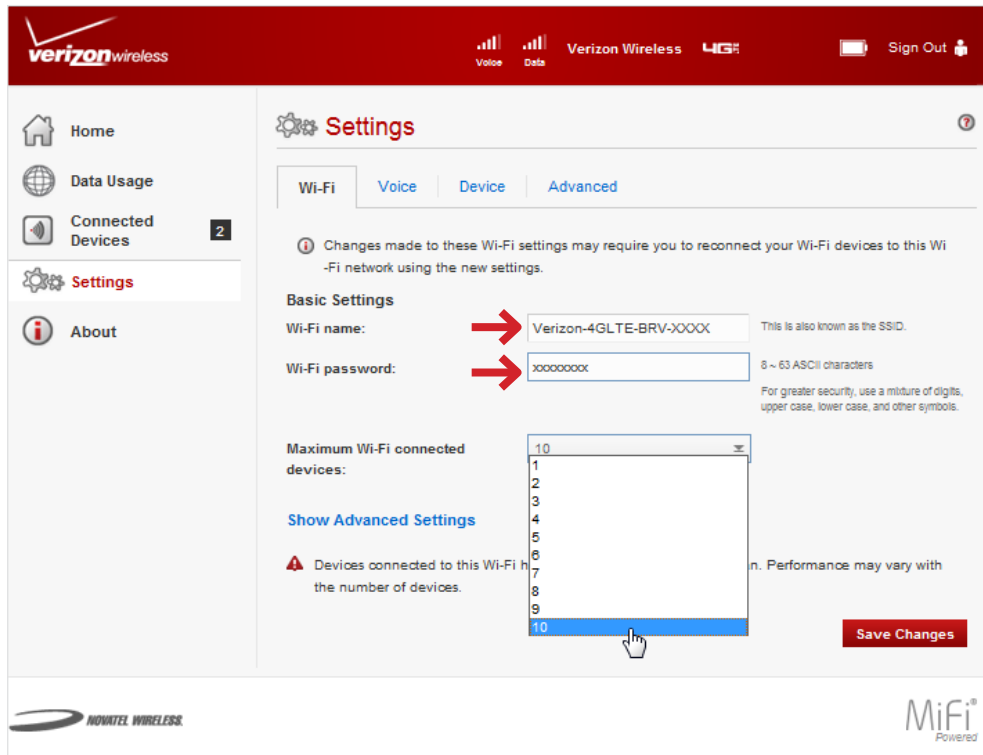

Change my Admin Password

Clicking on **Change my Admin Password** will take you to the Admin Password section of the Device menu on the Settings page. (See [Admin Password](#) on page 59.) The Admin Password page enables you to change the Admin Password. This is the password you use to Sign In to the 4G LTE Broadband Router with Voice web interface.

To change the Admin Password used to Sign In to your router:

- 1 Enter your current password in the **Enter current password** box.

The screenshot shows the Verizon Wireless web interface for the Admin Password settings. The top navigation bar includes the Verizon logo, signal strength indicators for Voice and Data, and a 'Sign Out' button. The left sidebar contains navigation options: Home, Data Usage, Connected Devices (with a '2' notification), Settings (highlighted), About, and Customer Support. The main content area is titled 'Settings' and has tabs for 'Wi-Fi', 'Voice', 'Device' (selected), and 'Advanced'. Under the 'Device' tab, there are sub-tabs for 'Admin Password', 'Preferences', 'Software Update', and 'Backup and Restore'. The 'Admin Password' section includes an information icon and a note: 'The Admin Password is used to sign in to this website.' Below this is a 'Display Admin Password' toggle switch, currently set to 'ON'. The 'Change Admin Password' section features three input fields: 'Enter current password:', 'Enter new password:', and 'Confirm new password:'. Red arrows point to each of these fields. To the right of the 'Enter new password' field, there is a note: 'Password must be at least 6 characters.' At the bottom right of the form is a red 'Save Changes' button with a hand cursor icon. The footer of the page includes the 'NOVATEL WIRELESS' logo and the 'MiFi Powered' logo.

- 2 Enter your new password in the **Enter new password** box.
- 3 Re-enter your new password in the **Confirm new password** box.
- 4 Click **Save Changes**.
- 5 A message displays confirming that your Admin Password has been changed.

Next time you Sign In to your 4G LTE Broadband Router with Voice, you need to use the new Admin Password.

NOTE To recover a forgotten password, scroll to **About > More > More** on the router to display the URL and Admin Password. If you have configured the router not to display the Admin Password on the router display, you will need to reset the router.

My Account & Tools

The My Account & Tools menu contains the following options:

- **My Verizon Wireless**
- **Coverage Map**
- **Data Calculator**

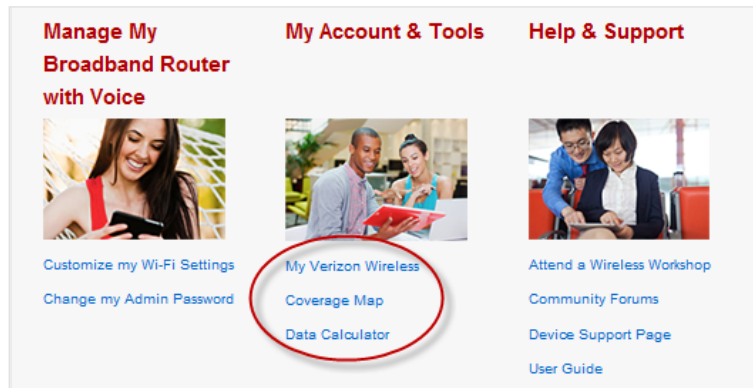

My Verizon Wireless*

My Verizon Wireless allows you to manage your account, pay your bill, purchase accessories and more. Register at [verizonwireless.com/myverizon](https://www.verizonwireless.com/myverizon).

Coverage Map*

Click on **Coverage Map** to access the Verizon Wireless coverage map.

Data Calculator*

Click on **Data Calculator** to calculate your data usage and select the best plan to meet your data requirements.

* Using these links may count against your data usage

Help & Support

The Help & Support menu contains the following options:

- **Attend a Wireless Workshop**
- **Community Forums**
- **Device Support Page**
- **User Guide**

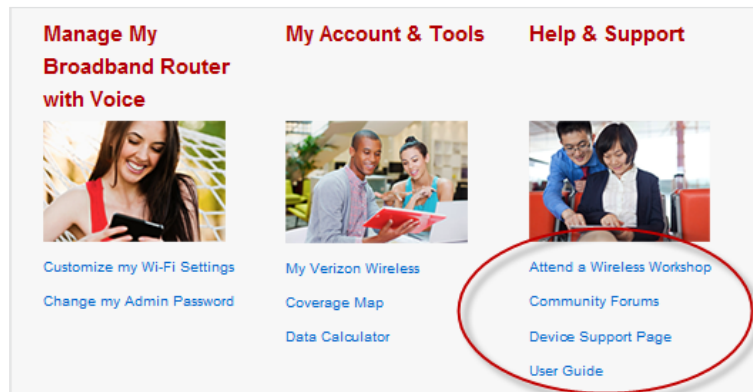

Attend a Wireless Workshop*

Click on **Attend a Wireless Workshop** to attend a free Wireless Workshop online or in a store to learn everything you need to know about your 4G LTE Broadband Router with Voice.

Community Forums*

Click on **Community Forums** to follow, share and participate in the Broadband & Netbook Community. In addition, you can search Broadband & Netbook Community discussions for specific topics.

Device Support Page*

Click on **Device Support Page** to join and discuss the latest news in Verizon Wireless products, services, and more.

User Guide*

Click on **User Guide** to access an online version of this 4G LTE Broadband Router with Voice User Guide.

* Using these links may count against your data usage

Data Usage

If you subscribe to an eligible data only or voice and data plan, you can quickly and easily check your data usage and billing cycle directly on the 4G LTE Broadband Router with Voice, or on the router Web User Interface.

On the 4G LTE Broadband Router with Voice Display

- 1 To display your data usage and billing cycle schedule, press the select button on the Home screen to display the Menu options.



- 2 Using the scroll button, scroll to the **Data Usage** icon and press the select button to open the Data Usage screen and display your current data usage and billing cycle schedule.
- 3 To refresh the Data Usage screen, use the scroll button to highlight Refresh, then press the select button to update and display your current data usage and billing cycle schedule.
- 4 Press the select button to close the Data Usage screen and return to the Menu options.



On the 4G LTE Broadband Router with Voice Web User Interface

The Data Usage page allows you to obtain data usage and billing cycle information for your mobile broadband plan. Click **Data Usage** on the Menu panel to display the Data Usage page and access information specific to your particular plan. You can also access and manage your account by clicking on **My Verizon**.

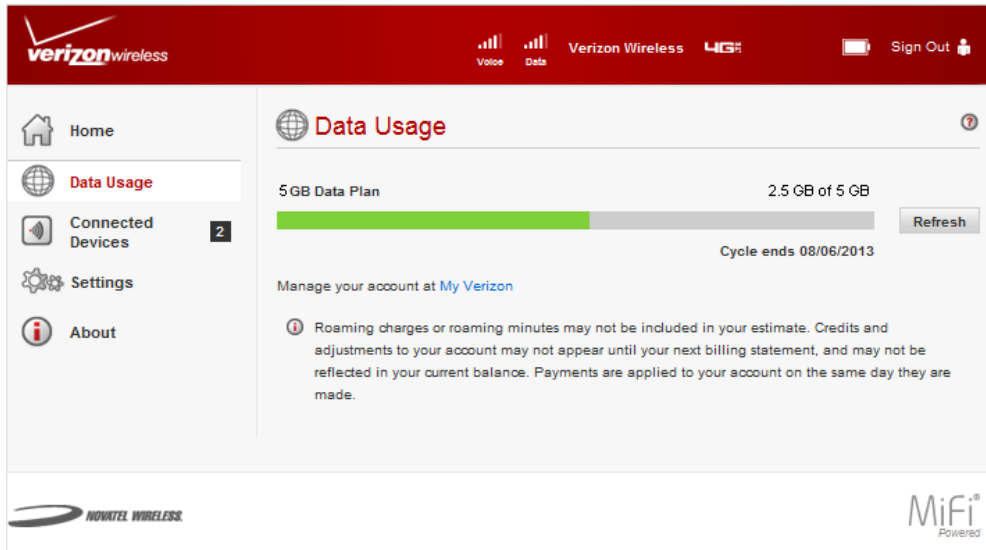

Wi-Fi Name/Password

You can quickly and easily find your current Wi-Fi Name/Password and the URL and Admin Password directly on the 4G LTE Broadband Router with Voice, or on the 4G LTE Broadband Router with Voice Web User Interface.

On the 4G LTE Broadband Router with Voice Display

- 1 To display your Wi-Fi Name and Password, press the select button on the Home screen to display the Menu options.
- 2 Using the scroll button, scroll to the Wi-Fi Name/Password icon and press the select button to open the Wi-Fi Name/Password screen and display your current Wi-Fi Name (SSID) and Password.

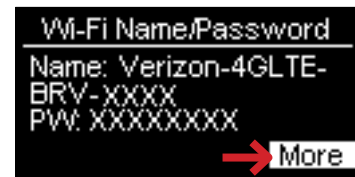

- 3 Select **More > More** to open the Admin screen and display the current URL and Admin Password.
- 4 Select **Close** to return to the Menu options.



On the 4G LTE Broadband Router with Voice Web User Interface

You can find your current Wi-Fi Name and Password, and the current URL and Admin Password on the 4G LTE Broadband Router with Voice Web User Interface. You can also change your Wi-Fi Name and Password, and your Admin Password. (See [Manage My Broadband Router with Voice](#) on page 36.)

Connected Devices

You can view and edit Wi-Fi capable devices currently connected to your 4G LTE Broadband Router with Voice, as well as any currently blocked devices.

On the 4G LTE Broadband Router with Voice Display

- 1 To display Wi-Fi capable devices currently connected to your 4G LTE Broadband Router with Voice, press the select button on the Home screen to display the Menu options.
- 2 Using the scroll button, scroll to the Connected Devices icon and press the select button to open the Connected Devices screen and display devices currently connected to or blocked from connecting to your router.
- 3 Use the scroll buttons to display device name and IP information for each connected device.
- 4 Press the select button to close the Connected Devices screen and return to the Menu options.



On the 4G LTE Broadband Router with Voice Web User Interface

The Connected Devices page allows you to view and edit devices that are currently connected to your 4G LTE Broadband Router with Voice. You can also view and unblock any blocked devices. The Connected Devices page contains the following:

- **Connected Devices** — displays the IP Address, MAC Address and Link Local IPv6 Address of up to ten connected wireless devices and up to three devices connected via ethernet.
- **Blocked Devices** — displays any blocked devices.

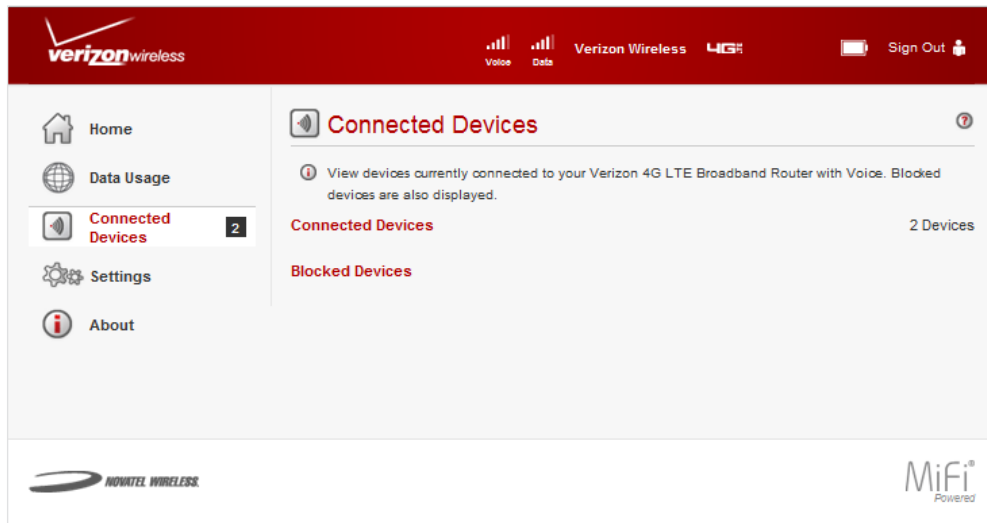

Connected Devices

The Connected Devices menu contains the following options:

- **Type** — indicates the type of connected device. You can use the **Edit** option to set or change the type. If the type has not been set, no icon is displayed. Once you set the device type, an appropriate icon is displayed.
- **Name** — displays the hostname of the connected device, as set on the connected device. If you have used this interface to assign a name to a connected device, the assigned name displays in place of the hostname. In rare cases, the hostname may be unavailable. You can use the **Edit** option to change the name of any connected device.
- **IP Address** — displays the IP address of the connected device.
- **MAC Address** — displays the MAC Address which is a unique network identifier for this connected device.
- **Link-Local Address**— displays the Link-Local IPv6 address if the connected device supports IPv6.
- **Edit** — allows you to edit a connected device type or name.

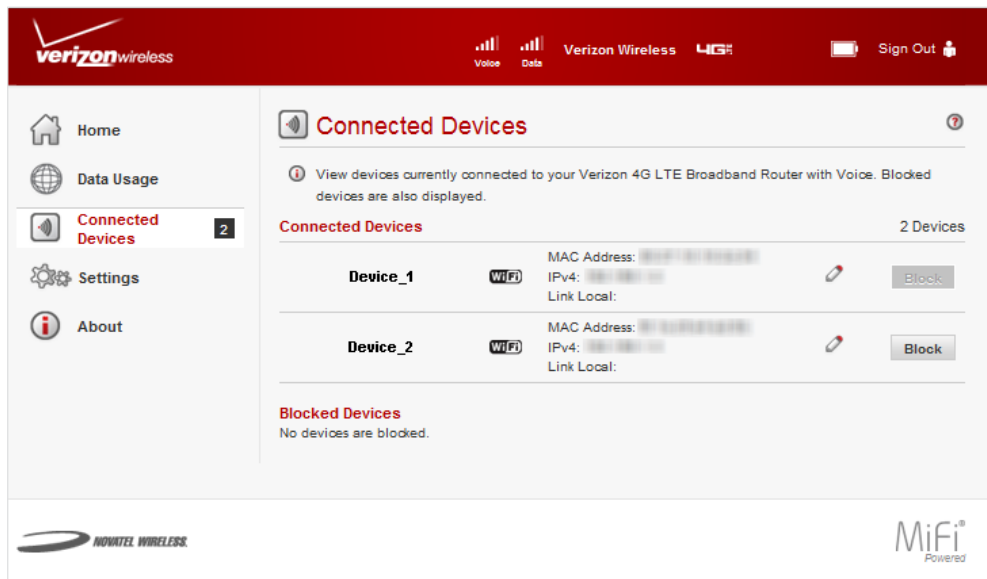

Edit a Connected Device

To select the device type, or to edit the name of a connected device:

- 1 Click the pencil tool. A page opens allowing you to select the device type, or to edit the name of a connected device.
- 2 Select the appropriate device type from the **Connected Devices** dropdown menu. Choose from Unknown, Computer, Handheld, or Other.
- 3 To change or revise the existing connected device name, type the desired name in the device name field.

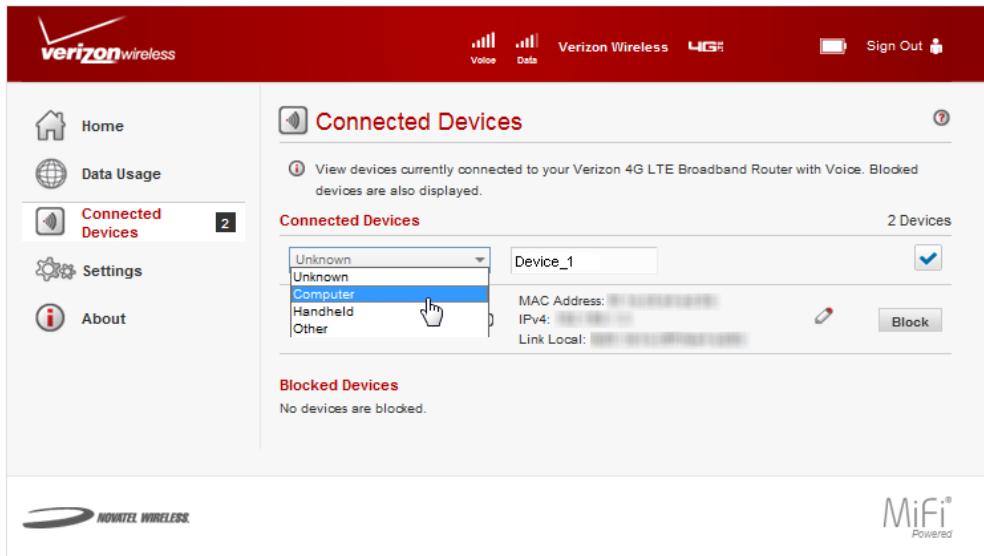

- 4 Click the checkmark to finish editing the device and save your changes.

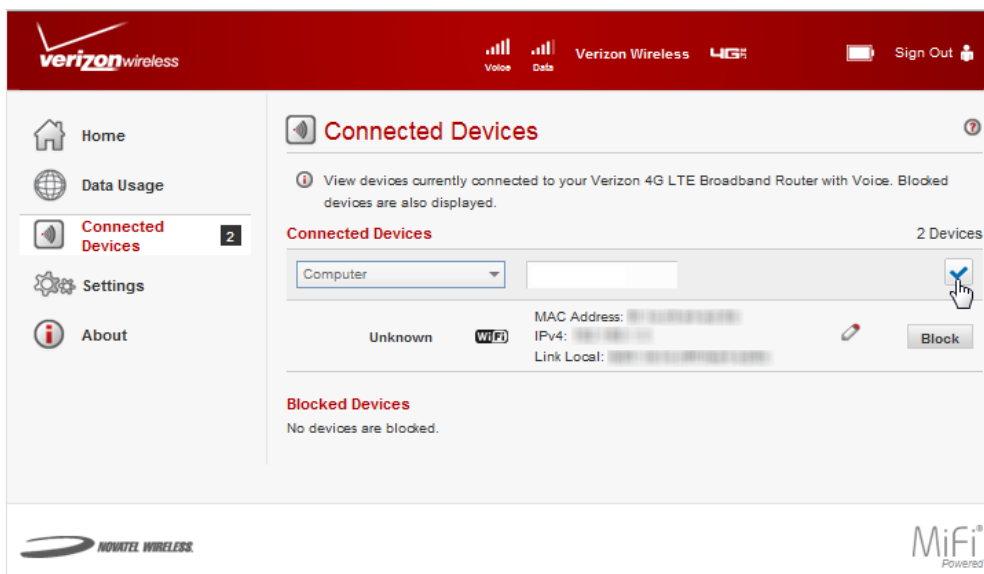

Change the Maximum Number of Connected Devices

To change the maximum number of connected devices:

- 1 Click **Settings** on the Menu panel to display the Wi-Fi Settings page.
- 2 Select the number of devices from the **Maximum Wi-Fi connected devices** dropdown menu.
- 3 Click **Save Changes**.

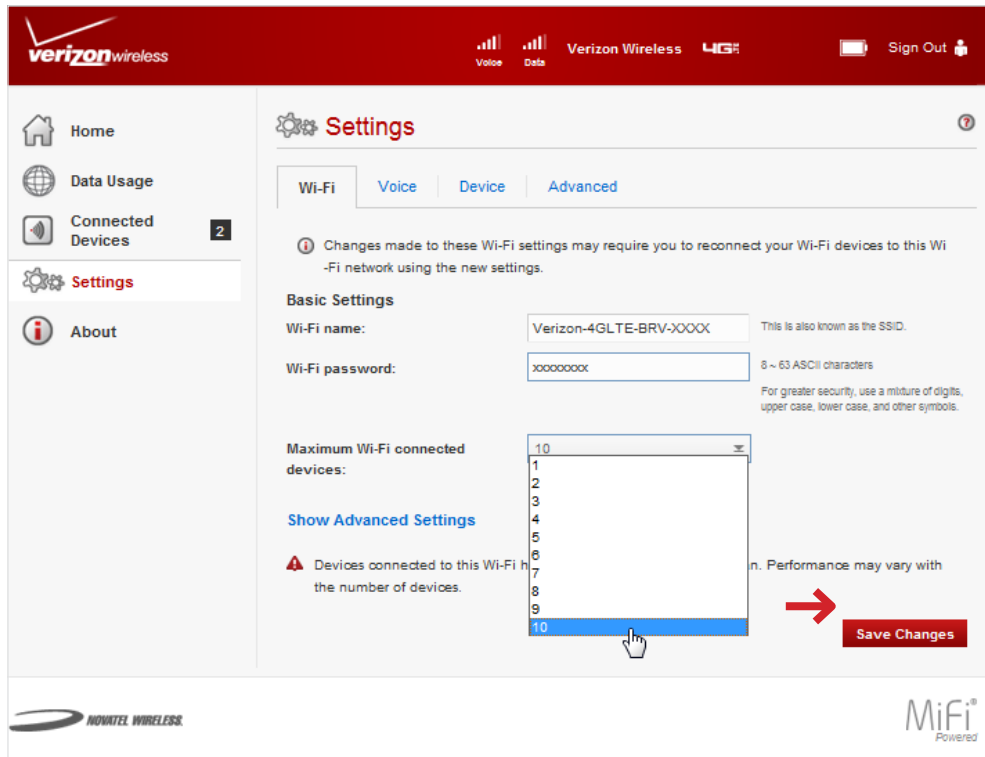

Blocked Devices

The Blocked Devices menu contains the following menu options:

- **Block Button** — click **Block** to disconnect a connected device and prevent it from reconnecting. The blocked device then appears in the **Blocked List**. This option is available for use with each connected device, except for your own device, and any devices connected via Ethernet.

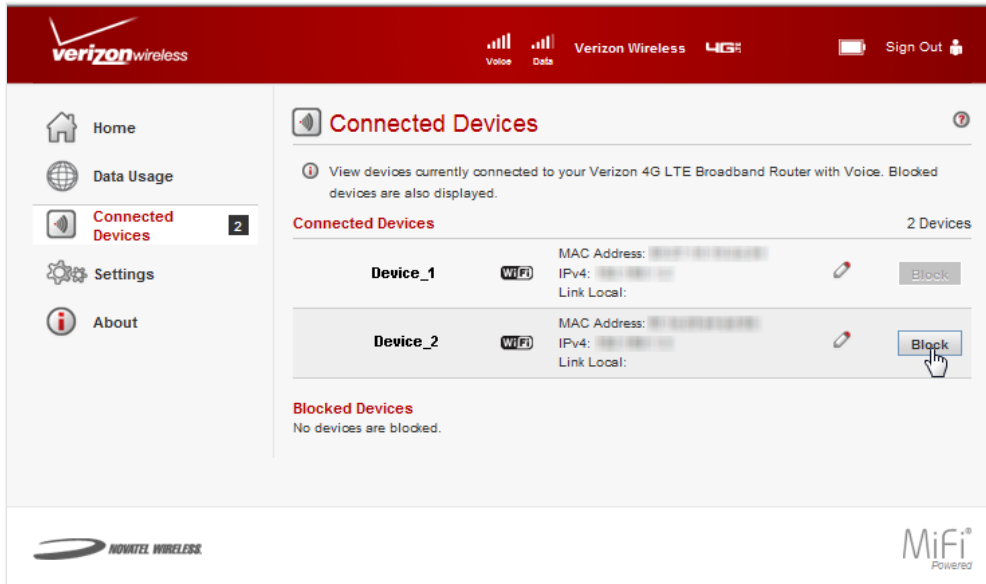

- **Blocked List** — lists any devices you have blocked. Note that since these devices are not currently connected, and are blocked from connecting, they do not have an IP address. Instead, they are identified by their name and MAC address.

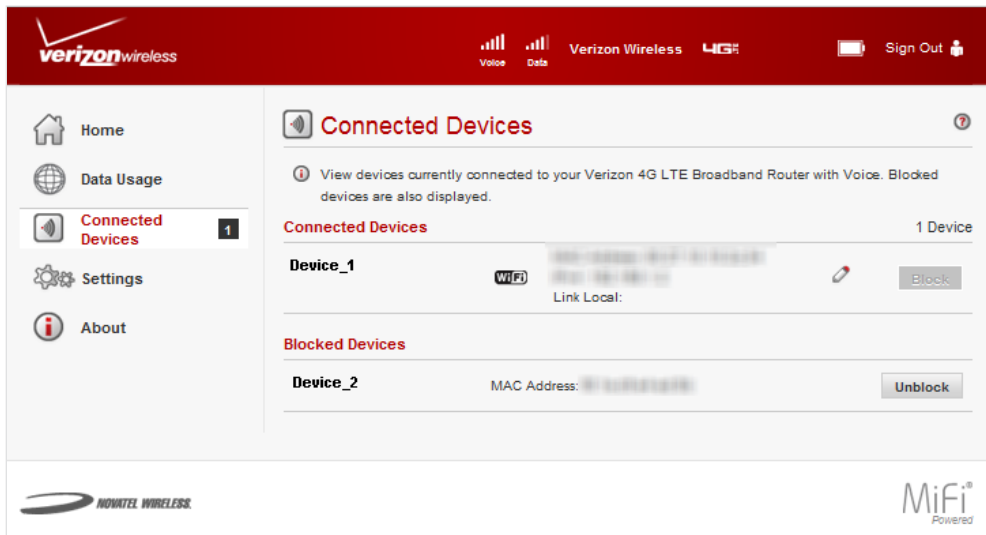

- **Unblock Button** — click **Unblock** to unblock a previously blocked device, freeing it to connect again. The unblocked device is deleted from the **Blocked List**, and will reappear in the **Connected Devices** list when it connects.

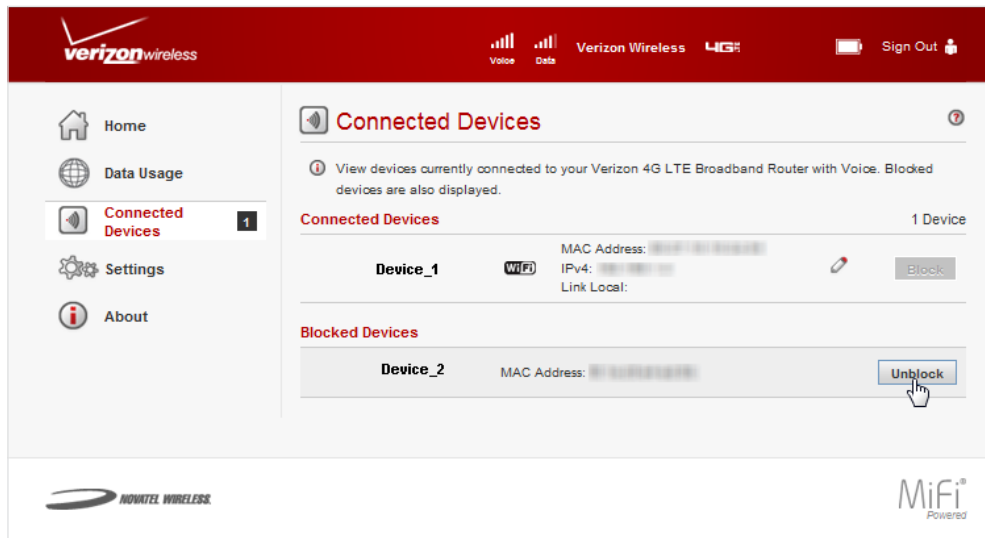

Voice Signal

Voice Signal displays the network Voice Signal strength on the Voice Signal indicator using one to five bars, and provides Voice Strength details including the Voice network operator, dBm Voice Signal measurement, and Ec/Io measurement.

On the 4G LTE Broadband Router with Voice Display

To display Voice Signal strength details:

- 1 Press the select button on the Home screen to display the Menu options.
- 2 Using the scroll button, scroll to the **Voice Signal** icon and press the select button to open the Voice Signal screen and display the current Voice Signal details.
- 3 Select **Close** to return to the Menu options.

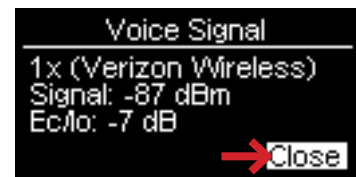

On the 4G LTE Broadband Router with Voice Web User Interface

To display the Voice Signal strength indicator on the 4G LTE Broadband Router with Voice Web User Interface, connect with the router and go to <http://VerizonBRV>. The Voice Signal strength indicator displays in the status bar at the top of the web interface.

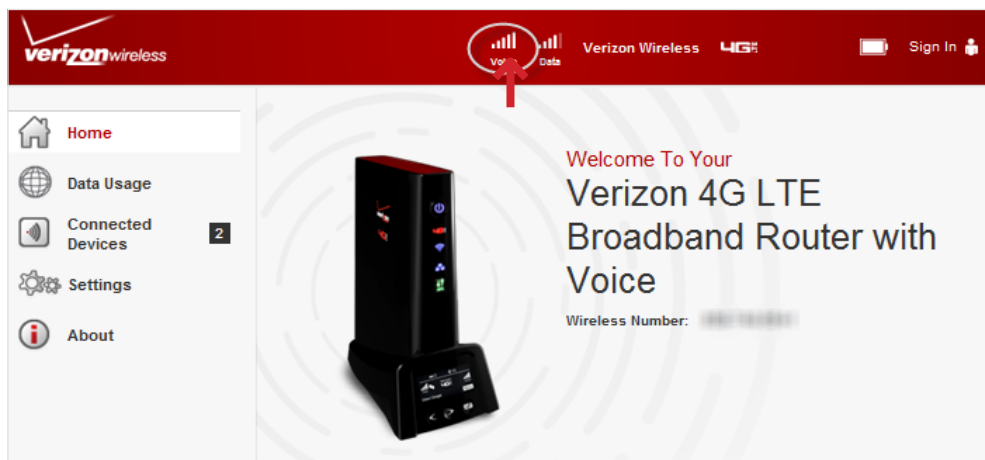

Data Signal

Data Signal displays the network Data Signal strength on the Data Signal indicator using one to five bars, and provides Data Strength details including the network type, dBm RSRP measurement, and dB RSRQ measurement.

On the 4G LTE Broadband Router with Voice Display

To display Data Signal strength details:

- 1 Press the select button on the Home screen to display the Menu options.
- 2 Using the scroll button, scroll to the **Data Signal** icon and press the select button to open the Data Signal screen and display the current Data Signal details.
- 3 Select **Close** to return to the Menu options.

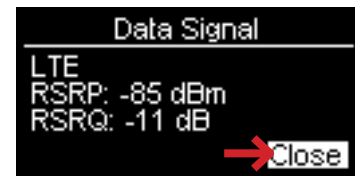
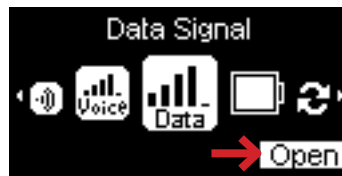

On the 4G LTE Broadband Router with Voice Web User Interface

To display the Data Signal strength indicator on the 4G LTE Broadband Router with Voice Web User Interface, connect with the router and go to <http://VerizonBRV>. The Data Signal strength indicator displays in the status bar at the top of the web interface.

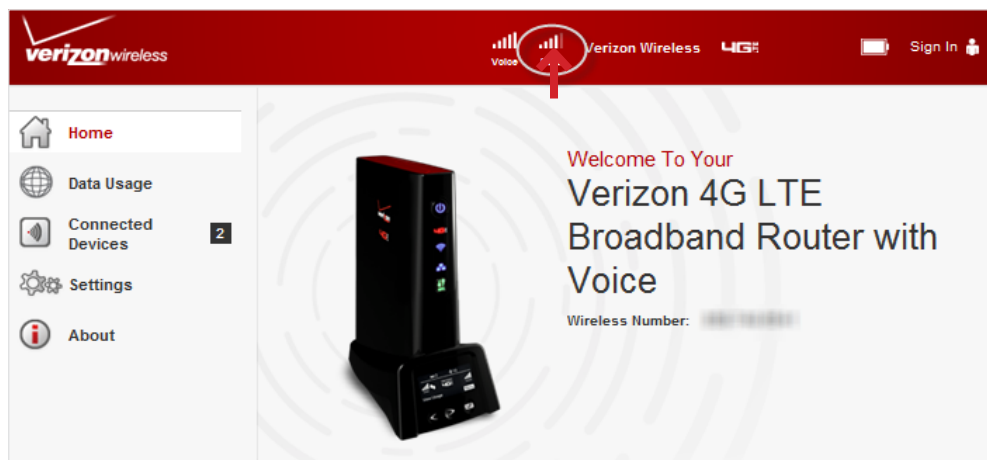

Battery

Battery displays the 4G LTE Broadband Router with Voice battery strength on the Battery indicator. A fully charged battery displays solid white.

On the 4G LTE Broadband Router with Voice Display

To display Battery strength:

- 1 Press the select button on the Home screen to display the Menu options.
- 2 Using the scroll button, scroll to display the **Battery** indicator.



On the 4G LTE Broadband Router with Voice Web User Interface

To display the Battery strength indicator on the 4G LTE Broadband Router with Voice Web User Interface, connect with the router and go to <http://VerizonBRV>. The Battery strength indicator displays in the status bar at the top of the web interface.

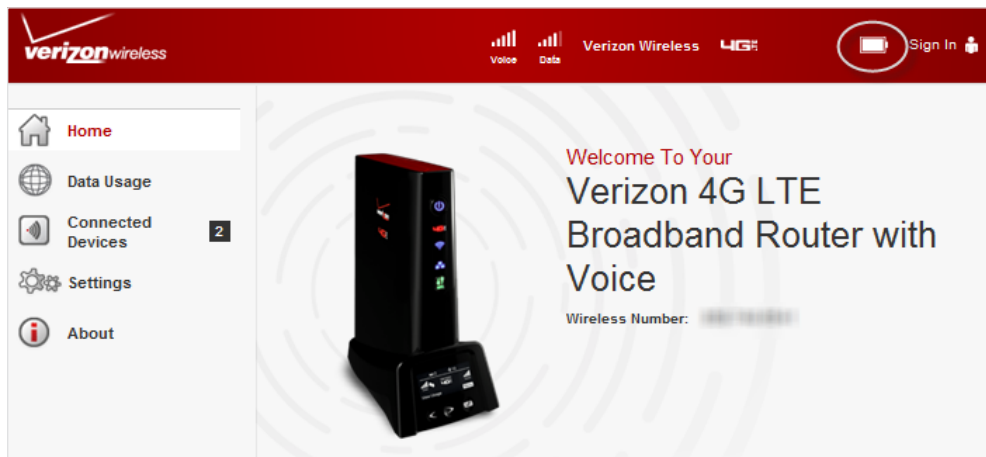

Settings

Settings allows you to make device changes, update software, and backup and restore files to your 4G LTE Broadband Router with Voice.

On the 4G LTE Broadband Router with Voice Display

The Settings options on the 4G LTE Broadband Router with Voice allow you to view your Wi-Fi Name and Password, your Admin Password, and to check for an available Software update.

To display your Wi-Fi Name/Password and the Web User Interface URL/Admin Password:

- 1 Press the select button on the Home screen to display the Menu options.
- 2 Using the scroll button, scroll to the **Wi-Fi Name/Password** icon and press the select button to open the Wi-Fi Name/Password screen and display your current Wi-Fi Name (SSID) and Password.

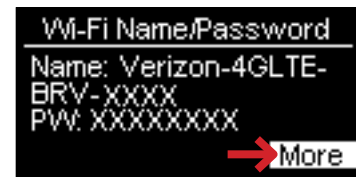

- 3 Select **More > More** to open the Admin screen and display the web interface URL and Admin Password.
- 4 Select **Close** to return to the Menu options.



To check for available Software updates:

- 1 Press the select button on the Home screen to display the Menu options.
- 2 Using the scroll button, scroll to the **Software Update** icon and press the select button to open the Software Update screen and display the current Software version and the date of the last check for an update.

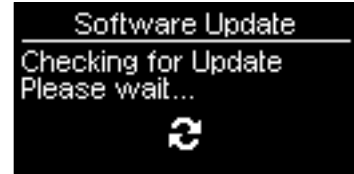

- 3 To check for an available update, select **Check Now**.
- 4 Select **Close** to return to the Menu options.

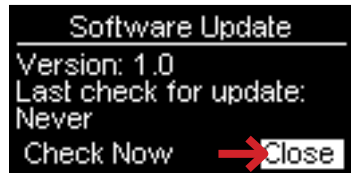
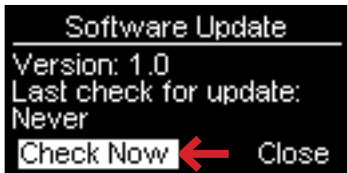

On the 4G LTE Broadband Router with Voice Web User Interface

The Settings page allows you to make Wi-Fi Name and Password, Admin Password and preference changes; change voice settings; obtain software update information; and backup and restore files to your router. The Settings page contains the following menu options:

- **Wi-Fi** (See [Wi-Fi](#) on page 56.)
- **Voice** (See [Voice](#) on page 59.)
- **Device** (See [Device](#) on page 62.)
- **Advanced** (See [Advanced](#) on page 66.)

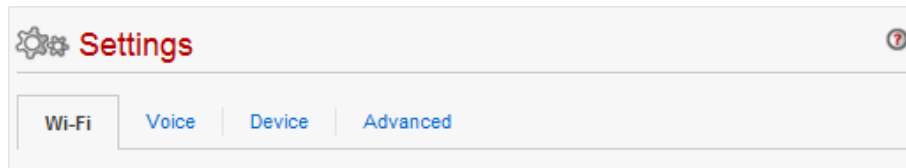

Wi-Fi

The Wi-Fi page contains the following sections:

- **Basic Settings** (See [Basic Settings](#) on page 56.)
- **Show Advanced Settings** (See [Show Advanced Settings](#) on page 57.)

The screenshot shows the Verizon Wireless Wi-Fi settings interface. At the top, there's a red header with the Verizon logo and status icons for voice and data. A left sidebar contains navigation options: Home, Data Usage, Connected Devices (with a '2' badge), Settings (highlighted), and About. The main content area is titled 'Settings' and has four tabs: 'Wi-Fi', 'Voice', 'Device', and 'Advanced'. The 'Wi-Fi' tab is selected. Below the tabs, a warning icon and text state: 'Changes made to these Wi-Fi settings may require you to reconnect your Wi-Fi devices to this Wi-Fi network using the new settings.' Under 'Basic Settings', there are three fields: 'Wi-Fi name' (containing 'Verizon-4GLTE-BRV-xxxx'), 'Wi-Fi password' (containing 'xxxxxxxx'), and 'Maximum Wi-Fi connected devices' (a dropdown menu set to '10'). To the right of the password field, there's a note: 'This is also known as the SSID. 8 - 63 ASCII characters. For greater security, use a mixture of digits, upper case, lower case, and other symbols.' Below these fields is a 'Show Advanced Settings' link. At the bottom, a warning icon and text state: 'Devices connected to this Wi-Fi hotspot use data from your data plan. Performance may vary with the number of devices.' A red 'Save Changes' button is located at the bottom right. The footer includes the 'Verizon Wireless' logo and 'MiFi Powered' branding.

Basic Settings

The Basic Settings section of the Wi-Fi page displays the current Wi-Fi Name and Password, and the maximum number of connected devices allowed.

To change these settings:

- 1 Enter the desired Wi-Fi Name (SSID) in the Wi-Fi name field.
- 2 Enter the desired Password in the Wi-Fi password field.
- 3 Select the maximum number of connected Wi-Fi devices desired from the Maximum Wi-Fi connected devices dropdown menu.
- 4 Click **Save Changes**.

Show Advanced Settings

The Advanced Settings section of the Wi-Fi page displays current advanced setting options, including:

- **Band** — allows selection of the desired Band option. The 2.4 GHz is widely supported. Do not select the 5 GHz option unless you know it is supported by your Wi-Fi devices.
- **Bandwidth** — only available if the Band setting is set to 5 GHz. The wideband (40 MHz) option provides potentially greater throughput, but may cause interference with other wireless devices.
- **Channel** — should be left on **Automatic** unless you need to choose a particular channel for your environment.
- **802.11 mode** — changes the Wi-Fi mode, if required. If all of your connected devices support 802.11n, selecting the option “802.11n only” will provide the best performance. In other cases, it is recommended that you leave this setting at its default value.
- **Security** — allows selection of the desired Wi-Fi security option. WPA2 is the latest and most secure method, and should be used if possible. **None** allows other people to monitor your Wi-Fi traffic and use your data plan to access the Internet. If at all possible, using None should be avoided. Using **WPA2** is strongly recommended, as this is the most secure method supported.
- **Display Wi-Fi name** — turn on to display the Wi-Fi name on the device display.
- **Display Wi-Fi password** — turn on to display the password on the device display.
- **Broadcast Wi-Fi name** — turn on to display this Wi-Fi network in the list of available Wi-Fi networks on your connected devices. Turn off to make this network invisible.
- **Wi-Fi privacy separation** — turn on to isolate each connected device from all other connected devices. This provides additional security if some connected devices are unknown or not completely trusted. For normal operation, this should be turned off.
- **Wi-Fi Multimedia (WMM)** — when on, assists in throughput. If using 802.11n, it must be turned on.
- **WPS** — allows Wi-Fi devices to connect to a Wi-Fi network without having to manually enter the network key. If turned on in the Web User Interface, compatible Wi-Fi devices can be connected to the 4G LTE Broadband Router with Voice using the WPS option on the router display.

To display and customize Advanced Settings options:

- 1 Click **Show Advanced Settings** to display the Advanced Settings options.
- 2 Select the desired setting from the selected option dropdown menu.
- 3 To turn on or off a selected setting, use the option check box.

The screenshot shows the Verizon Wireless Settings application. The top navigation bar includes the Verizon logo, signal strength indicators for Voice and Data, 'Verizon Wireless' text, a 4G LTE icon, and a 'Sign Out' button. The left sidebar contains navigation options: Home, Data Usage, Connected Devices (with a '2' notification badge), Settings (highlighted in red), and About. The main content area is titled 'Settings' and has tabs for 'Wi-Fi', 'Voice', 'Device', and 'Advanced'. A warning message states: 'Changes made to these Wi-Fi settings may require you to reconnect your Wi-Fi devices to this Wi-Fi network using the new settings.' Under 'Basic Settings', there are fields for 'Wi-Fi name' (Verizon-4GLTE-BRV-XXXX), 'Wi-Fi password' (xxxxxxxx), and 'Maximum Wi-Fi connected devices' (10). The 'Hide Advanced Settings' section includes dropdowns for 'Band' (2.4 GHz), 'Channel' (Automatic), and '802.11 mode' (802.11b + 802.11g + 802....). The 'Security' dropdown is set to 'WPA2 Personal/PSK (AES)'. Below these are several checkboxes: 'Display Wi-Fi name' (checked), 'Display Wi-Fi password' (checked), 'Broadcast Wi-Fi name' (checked), 'Wi-Fi privacy separation' (unchecked), 'Wi-Fi Multimedia (WMM)' (checked), and 'WPS' (checked). A red warning triangle at the bottom states: 'Devices connected to this Wi-Fi hotspot use data from your data plan. Performance may vary with the number of devices.' A red 'Save Changes' button is located at the bottom right. The footer features the 'NOVATEL WIRELESS' logo on the left and the 'MiFi Powered' logo on the right.

Voice

The Voice page contains the following options:

- **TTY** — allows those who are hearing impaired to use their telephone to type messages back and forth with another TTY supporting device. A TTY capable device is required at both ends of the connection in order to work properly.
- **Start dial timeout** — sets the period of time the dial tone will be available when the phone receiver is off the hook. Options are 1 ~ 20 seconds.
- **Inter-digit timeout** — sets the period of silence following remote hangup. Options are 1 ~ 10 seconds.
- **Remote party hangup timeout** — sets the period of silence following remote hangup. Options are 1 ~ 20 seconds.

NOTE Changing the Voice settings may impair operation of your Verizon 4G LTE Broadband Router with Voice.

To change the default Voice Settings:

- 1 Click **Settings > Voice > Continue** to display the Voice Settings options.

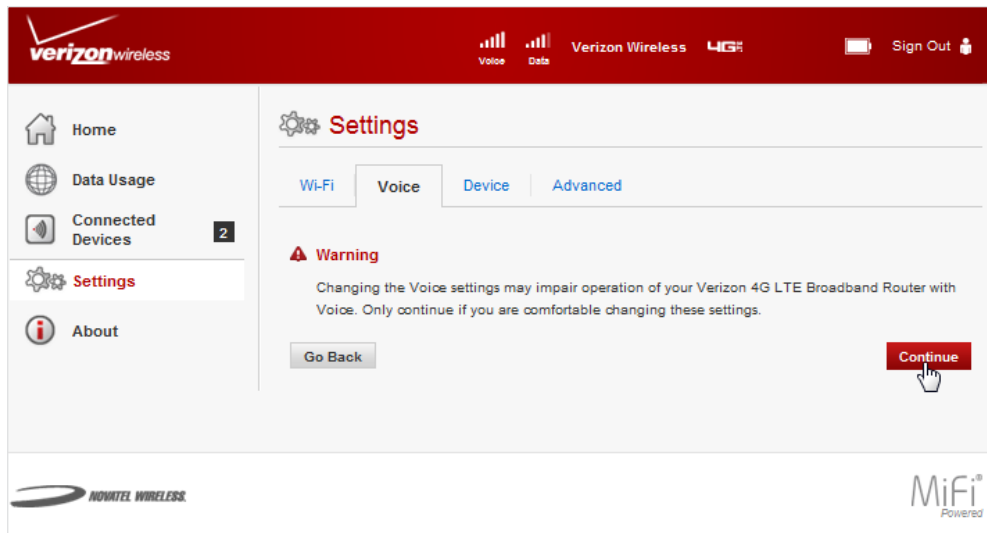

- 2 If a TTY device is connected to the 4G LTE Broadband Router with Voice, select the appropriate TTY setting from the TTY dropdown menu. The default setting is **Disabled**.

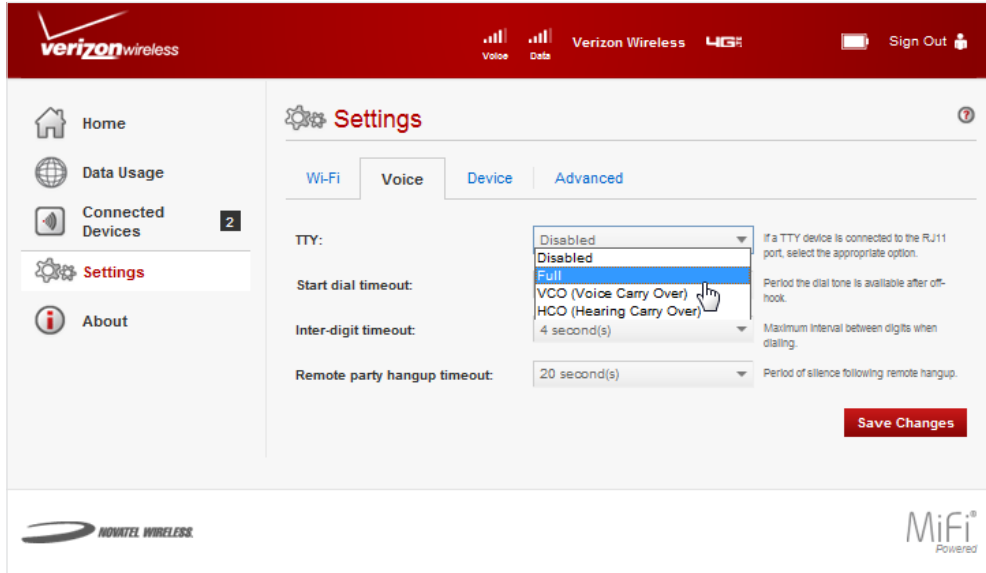

- 3 To change the period of time the dial tone is available after the phone is off-hook, select the desired time interval from the **Start dial timeout** dropdown menu. Choose from 1 - 20 seconds.

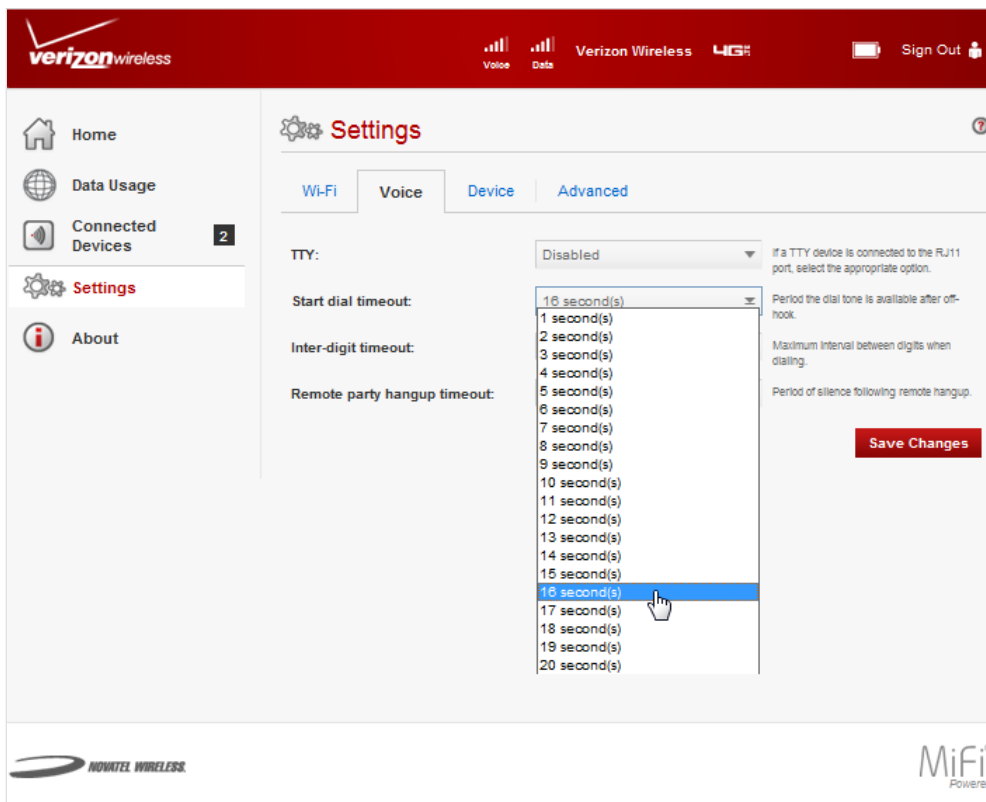

- 4 To change the maximum period of time between digits when dialing, select the desired time interval from the **Inter-digit timeout** dropdown menu. Choose from 1 - 10 seconds.

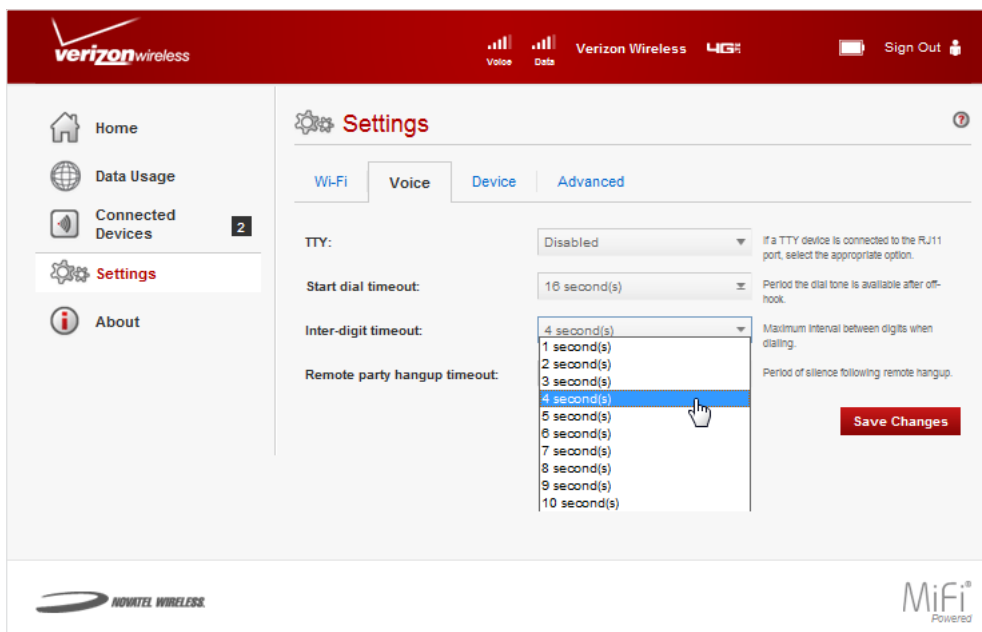

- 5 To change the period of silence following remote hangup, select the desired time interval from the **Remote party hangup timeout** dropdown menu. Choose from 1 - 20 seconds.

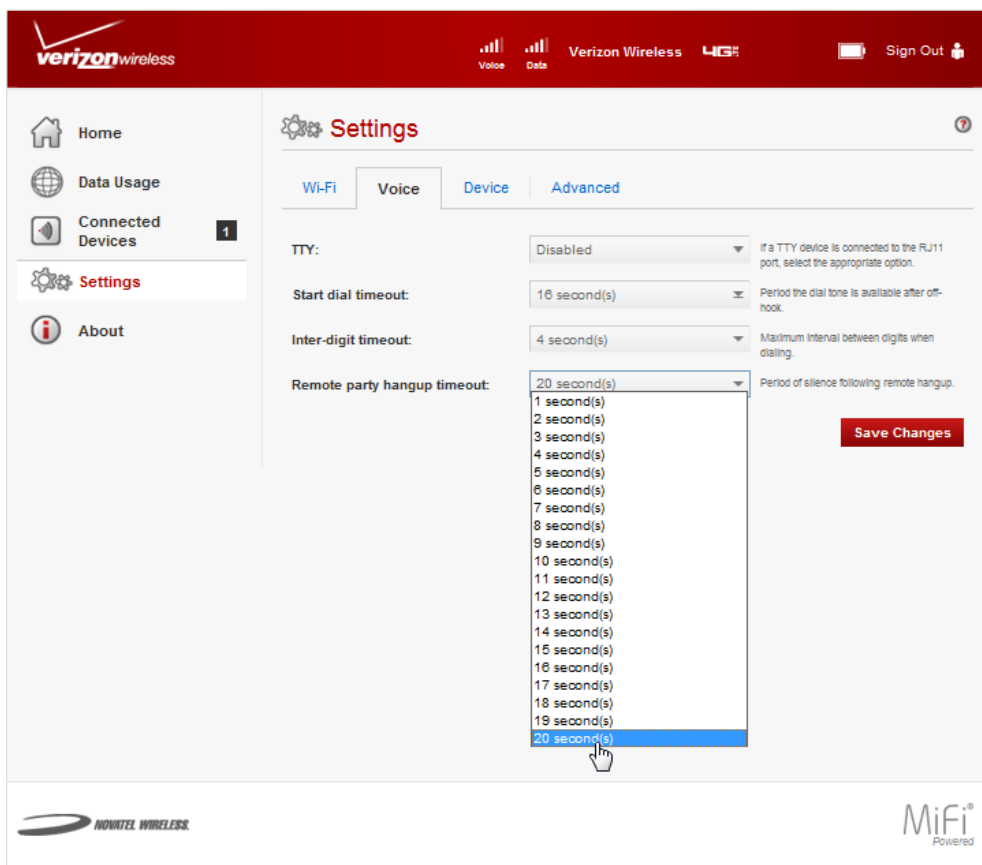

- 6 Click **Save Changes**.

Device

The Device page includes the following options:

- **Admin Password** — used to Sign In to the Web User Interface. The Admin Password page allows you to change the Admin Password, and to set a security option relating to the display of the Admin Password on the device.
- **Preferences** — allows you to set the time interval when the device display turns off after a period of inactivity.
- **Software Update** — allows you to monitor software updates automatically delivered over the mobile network.
- **Backup and Restore** — allows you to download a copy of the configuration settings from the 4G LTE Broadband Router with Voice to a file on your computer, or upload a previously-saved configuration file. This configuration file contains all settings for the device, router and system functions. It does not contain any settings or data for the 4G modem.

NOTE You can only restore a file to the same device it came from.

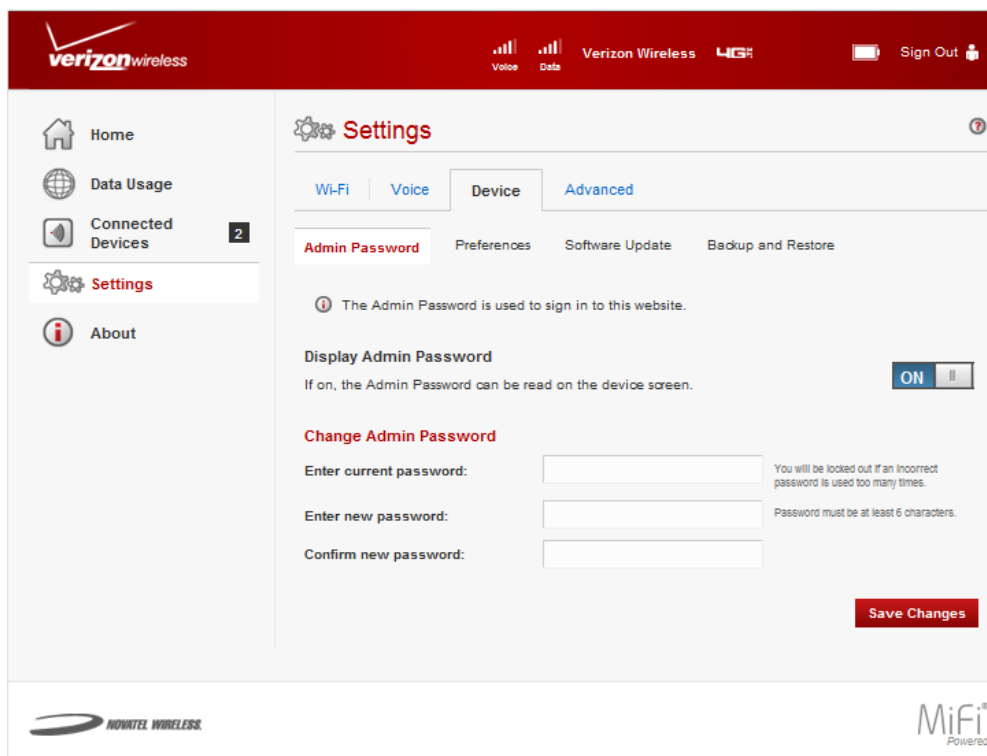

The screenshot displays the Verizon Wireless web interface. At the top, there is a red header with the Verizon logo and status icons for Voice, Data, Verizon Wireless, 4G, and a Sign Out button. A left sidebar contains navigation options: Home, Data Usage, Connected Devices (with a '2' notification), Settings (highlighted), and About. The main content area is titled 'Settings' and has tabs for Wi-Fi, Voice, Device (selected), and Advanced. Under the 'Device' tab, there are sub-tabs for Admin Password, Preferences, Software Update, and Backup and Restore. The 'Admin Password' sub-tab is active, showing a message: 'The Admin Password is used to sign in to this website.' Below this is a 'Display Admin Password' toggle switch, currently set to 'ON'. A section titled 'Change Admin Password' includes three input fields: 'Enter current password:', 'Enter new password:', and 'Confirm new password:'. A 'Save Changes' button is located at the bottom right of this section. The footer of the page features the Intel Wireless logo on the left and the MiFi Powered logo on the right.

Admin Password

To hide or display the Admin Password:

- Slide the **ON/OFF** button to **ON** to display the Admin Password on the device display or to **OFF** to hide the Admin Password on the router display.

To change the Admin Password:

- 1 Type your current Admin Password in the **Enter current password** field.
- 2 Type your new Admin Password in the **Enter new password** field.
- 3 Type your new Admin Password a second time in the **Confirm new password** field.
- 4 Click **Save Changes** to save any changes made to your password.

The screenshot shows the Verizon Wireless Mifi Settings interface. The top navigation bar includes the Verizon Wireless logo, signal strength indicators for Voice and Data, the Verizon Wireless logo, a 4G LTE signal indicator, a battery icon, and a Sign Out button. The left sidebar contains navigation options: Home, Data Usage, Connected Devices (with a '2' notification), Settings (highlighted), and About. The main content area is titled 'Settings' and has tabs for Wi-Fi, Voice, Device, and Advanced. Under the 'Device' tab, there are sub-tabs for Admin Password, Preferences, Software Update, and Backup and Restore. The 'Admin Password' section includes a note: 'The Admin Password is used to sign in to this website.' Below this is a 'Display Admin Password' toggle switch, currently set to 'ON'. The 'Change Admin Password' section contains three input fields: 'Enter current password:', 'Enter new password:', and 'Confirm new password:'. The 'Enter new password:' field has a note: 'Password must be at least 6 characters.' The 'Confirm new password:' field has a note: 'You will be locked out if an incorrect password is used too many times.' A red 'Save Changes' button is located at the bottom right of the form. The bottom of the page features the 'MOTOROLA WIRELESS' logo on the left and the 'MiFi Powered' logo on the right.

NOTE Your new Admin Password must now be used to Sign In to this Web User Interface.

Preferences

The set the **Turn off display** time interval:

- 1 Select the desired time interval from the **Turn off display** dropdown menu. Choose from After 30 seconds, After 1 minute, After 2 minutes, After 5 minutes, or Never.
- 2 Click **Save Changes**.

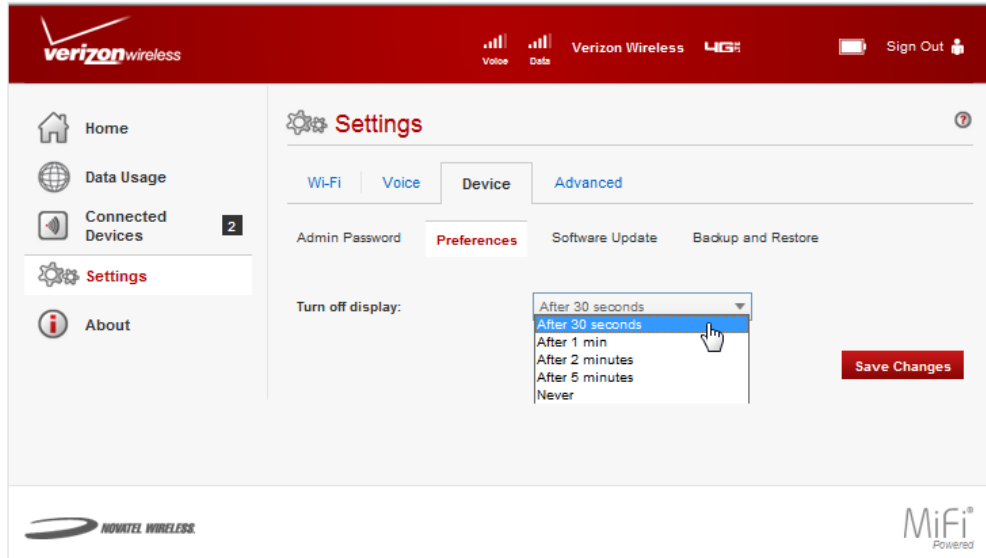

Software Update

The Software Update page contains the following sections:

- **Current software version** — displays the current software version installed on the 4G LTE Broadband Router with Voice.
- **Checked for update** — displays the date that the 4G LTE Broadband Router with Voice automatically checked for a software update.
- **Update available** — indicates if an update is available. If available, the update is automatically downloaded and installed.

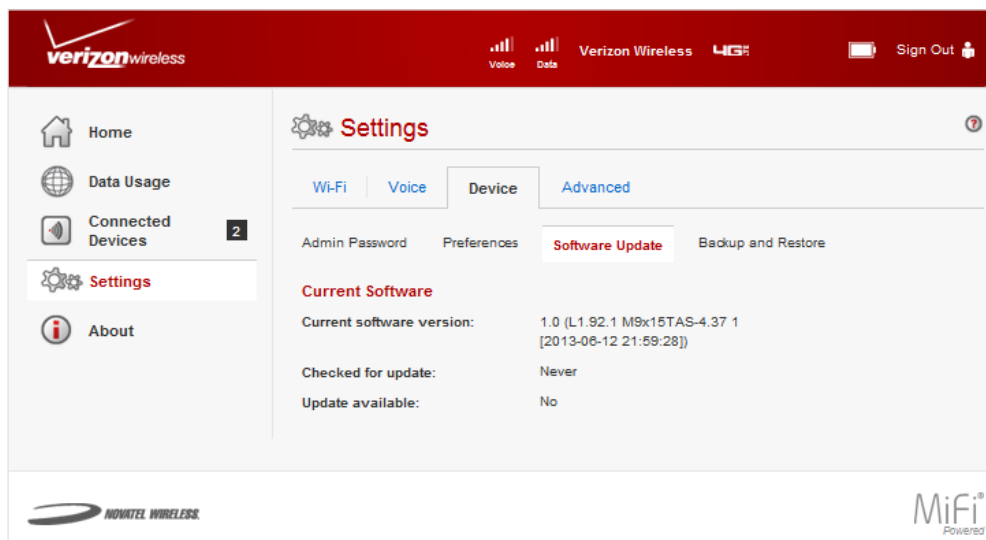

Backup and Restore

The Backup and Restore page contains the following sections:

- **Backup** — Allows you to save your 4G LTE Broadband Router with Voice settings as a config mifi file to your computer. You must enter your Admin Password in the **Admin Password** field and click **Download** to save settings to your computer.

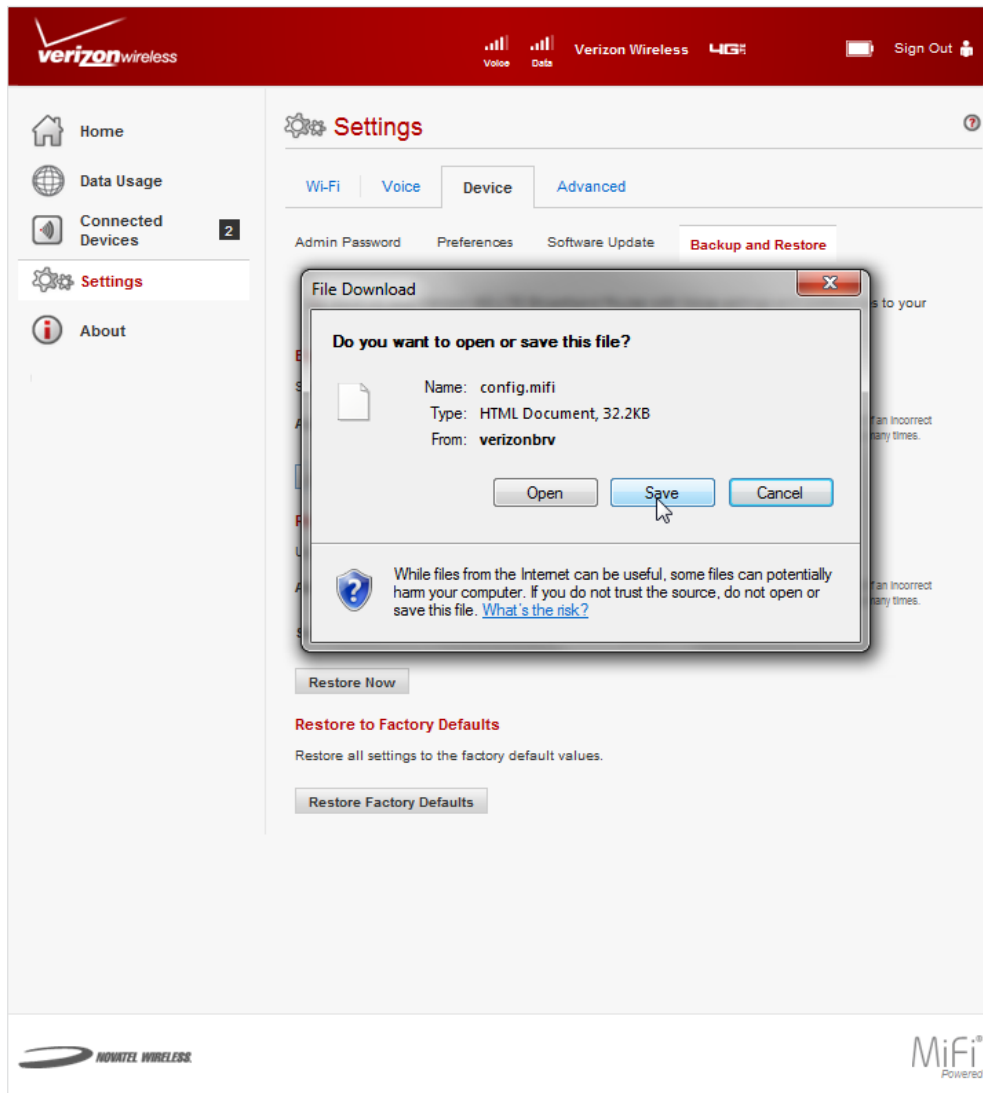

- **Restore** — Allows you to upload a previously saved backup file from your computer to your 4G LTE Broadband Router with Voice. Click **Browse** and select a file, then enter the Admin Password in effect when the backup file was saved in the **Admin Password** field and click **Restore Now**.

- **Restore to Factory Defaults** — Allows you to restore all settings on your 4G LTE Broadband Router with Voice to the factory default values. Click **Restore Factory Defaults** to restore all such settings. If prompted for a password, use the Admin Password which can be found on the 4G LTE Broadband Router with Voice by selecting **Menu > Wi-Fi Name/Password > More > More**.

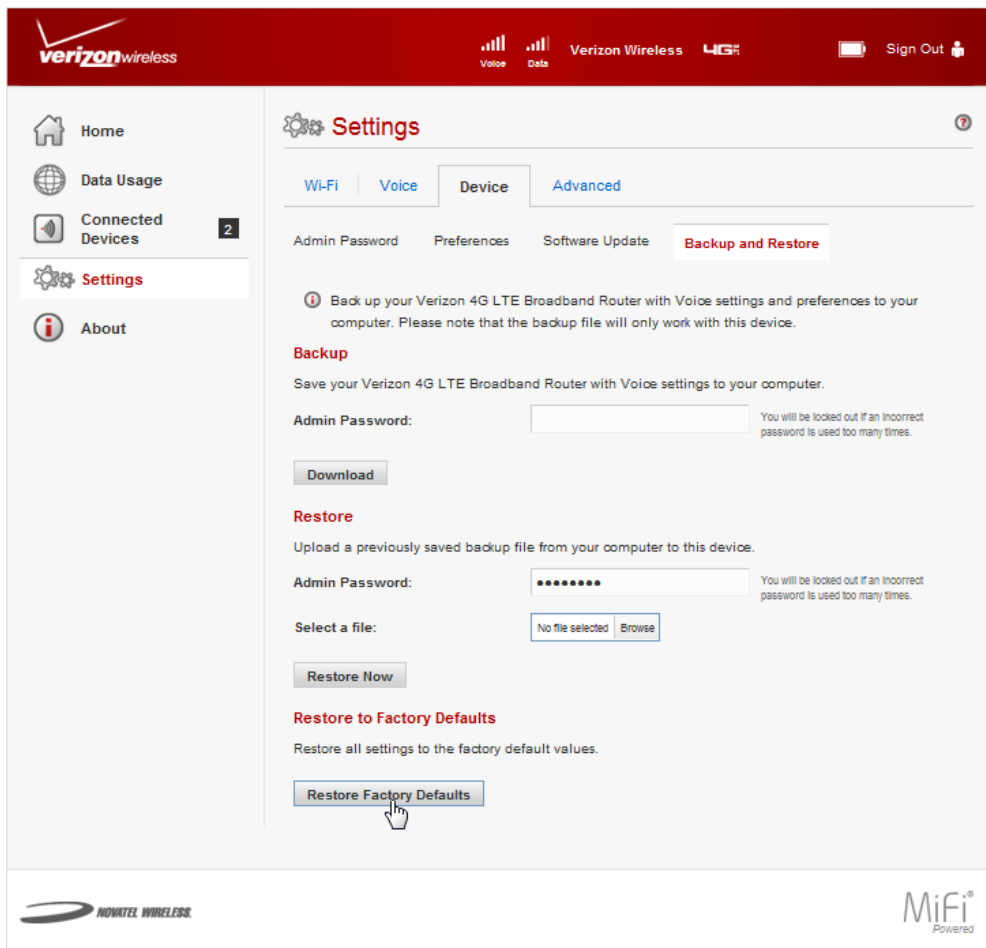

Advanced

The Advanced page allows you to change the 4G LTE Broadband Router with Voice advanced settings. The Advanced page provides manual DNS, firewall and LAN settings; and options for configuring port filtering and port forwarding applications.

WARNING! Changing the Advanced settings may be harmful to the stability, performance, and security of the 4G LTE Broadband Router with Voice.

The Advanced page includes the following options:

- **Manual DNS** — allows you to manually specify a Domain Name Server (DNS) if required.
- **Firewall** — allows you to select settings to protect your connected devices against malicious incoming traffic from the Internet and cannot be turned off.
- **LAN** — allows you to specify settings for your Local Area Network (LAN), which includes the 4G LTE Broadband Router with Voice and all connected devices.

- **Port Filtering** — allows you to block outgoing Internet traffic, identified by port numbers.
- **Port Forwarding** — allows you to permit incoming traffic from the Internet to be forwarded to a particular computer or device on your Wi-Fi network. Use to allow Internet users to access any server you are running on your computer, such as a web, FTP, or email server.

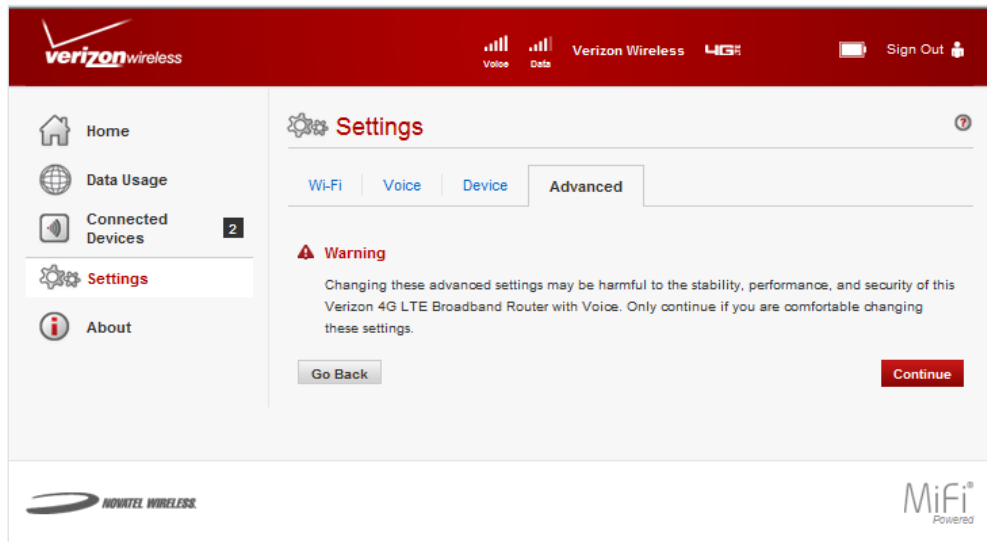

NOTE Port Forwarding must be used for some online games to function correctly. The use of Port Forwarding creates a security risk and should be turned off when not required.

Manual DNS

The 4G LTE Broadband Router with Voice automatically selects a Domain Name Server (DNS). The Manual DNS menu allows you to manually select up to two DNS IP addresses.

To manually select a Domain Name Server, follow these steps:

- 1 Click the box next to **Manual DNS**.
- 2 Enter the IP address for the first DNS in the **DNS 1 IP address** field.
- 3 Enter the IP address for the second DNS in the **DNS 2 IP address** field, if applicable.
- 4 Click **Save Changes**.

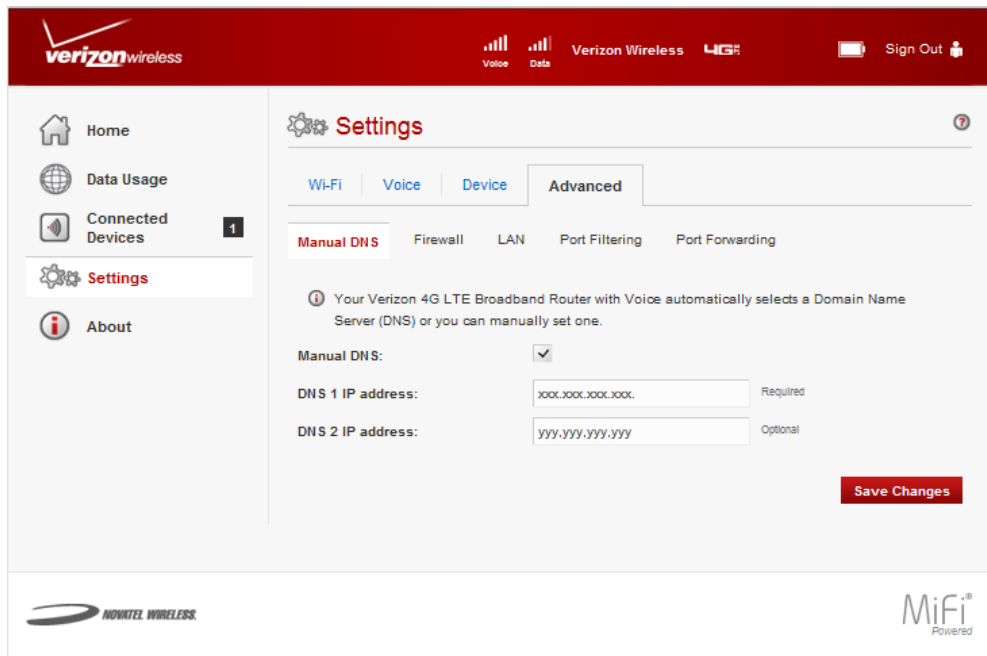

The screenshot shows the Verizon Wireless MiFi settings interface. At the top, there is a red header with the Verizon logo, signal strength indicators for Voice and Data, and the text "Verizon Wireless 4G". A "Sign Out" button is visible in the top right corner. On the left side, there is a navigation menu with icons for Home, Data Usage, Connected Devices (with a notification badge), Settings (highlighted in red), and About. The main content area is titled "Settings" and has tabs for "Wi-Fi", "Voice", "Device", and "Advanced". Under the "Advanced" tab, there are sub-tabs for "Manual DNS", "Firewall", "LAN", "Port Filtering", and "Port Forwarding". The "Manual DNS" sub-tab is active. Below the sub-tabs, there is an information icon and a message: "Your Verizon 4G LTE Broadband Router with Voice automatically selects a Domain Name Server (DNS) or you can manually set one." Below this message, there is a "Manual DNS:" label with a checked checkbox. There are two input fields: "DNS 1 IP address:" with a placeholder "xxx.xxx.xxx.xxx" and a "Required" label, and "DNS 2 IP address:" with a placeholder "yyy.yyy.yyy.yyy" and an "Optional" label. A red "Save Changes" button is located at the bottom right of the settings area. At the bottom of the page, there are logos for "INTEL WIRELESS" and "MiFi Powered".

Firewall

The 4G LTE Broadband Router with Voice firewall determines which Internet traffic is allowed. The Firewall menu contains the following sections:

- **VPN Passthrough** — turns on or off the VPN feature and allows or disallows connected devices to establish a VPN tunnel.
 - If this is **ON** (turned on), this feature allows VPN clients to connect through the 4G LTE Broadband Router with Voice to remote VPN Servers. Normally, this option should be turned on.
 - If this is **OFF** (turned off), VPN clients are not allowed to connect.
- **IPv6 Transparent Mode** — allows connected devices to be accessible from the Internet.
- **DMZ (IPv4)** — If turned on, the connected device specified as the DMZ IP address (DMZ destination) will receive all traffic which would otherwise be blocked by the firewall. This may assist some troublesome network applications to function properly, but the DMZ device should have its own firewall to protect itself against malicious traffic.

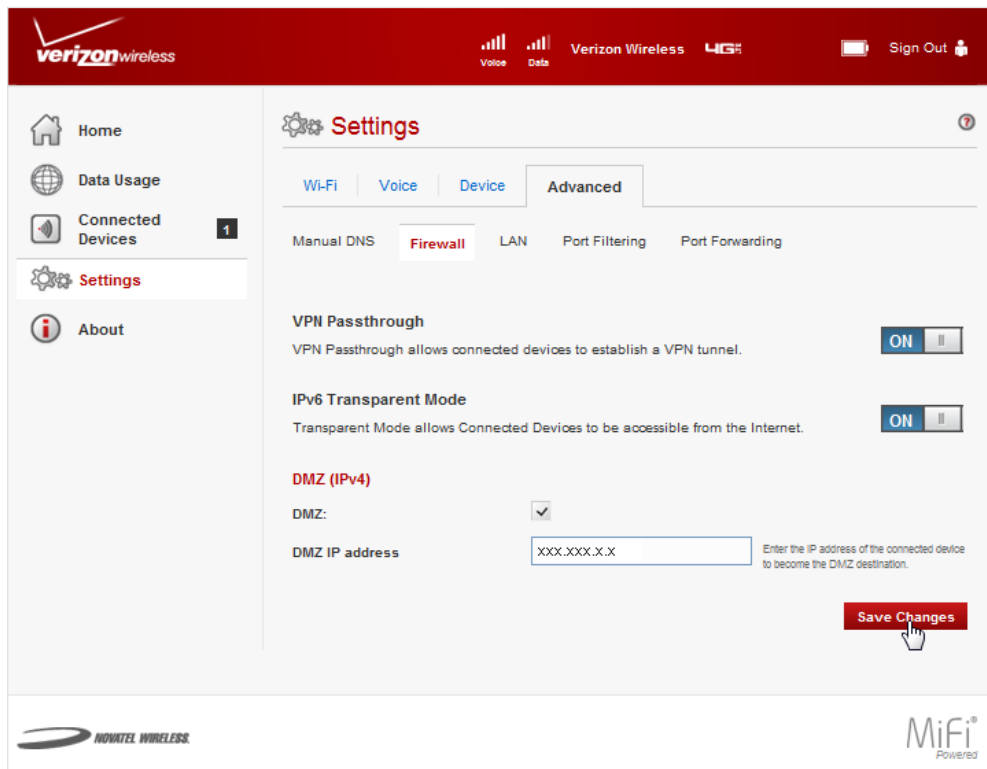

LAN

The LAN page provides settings and information about the 4G LTE Broadband Router with Voice's network. The LAN menu contains the following sections:

- **IPv4**
 - **IP address** — displays the IP address for the 4G LTE Broadband Router with Voice.
 - **Subnet mask** — displays the subnet mask network setting for the 4G LTE Broadband Router with Voice. The default value 255.255.255.0 is standard for small (class "C") networks. If you change the LAN IP Address, ensure you use the correct Subnet Mask for the IP address range containing the LAN IP address.
 - **MAC address** — displays the Media Access Controller (MAC) or physical address for the 4G LTE Broadband Router with Voice.
 - **DHCP server** — **DHCP Server** checkbox allows you to turn on or off the DHCP Server feature.
 - **Start DHCP address range at** — displays the start range of IP addresses reserved for use by the 4G LTE Broadband Router with Voice's DHCP server table.
 - **DHCP address range** — displays the current range of IP addresses reserved for use by the 4G LTE Broadband Router with Voice's DHCP server table. If a device with a static IP address wants to connect to the 4G LTE Broadband Router with Voice's network, the static IP should be outside of the DHCP address range. Most devices do not have a static IP.
 - **DHCP lease time** — determines how often connected devices must renew the IP address assigned to them by the DHCP server. Normally, this can be left at the default value, but if you have special requirements you can change this value.
- **IPv6**
 - **IPv6** — **IPv6** checkbox allows you to turn on or off the IPv6 feature.
 - **Link-Local address** — displays the local address when IPv6 is turned on.

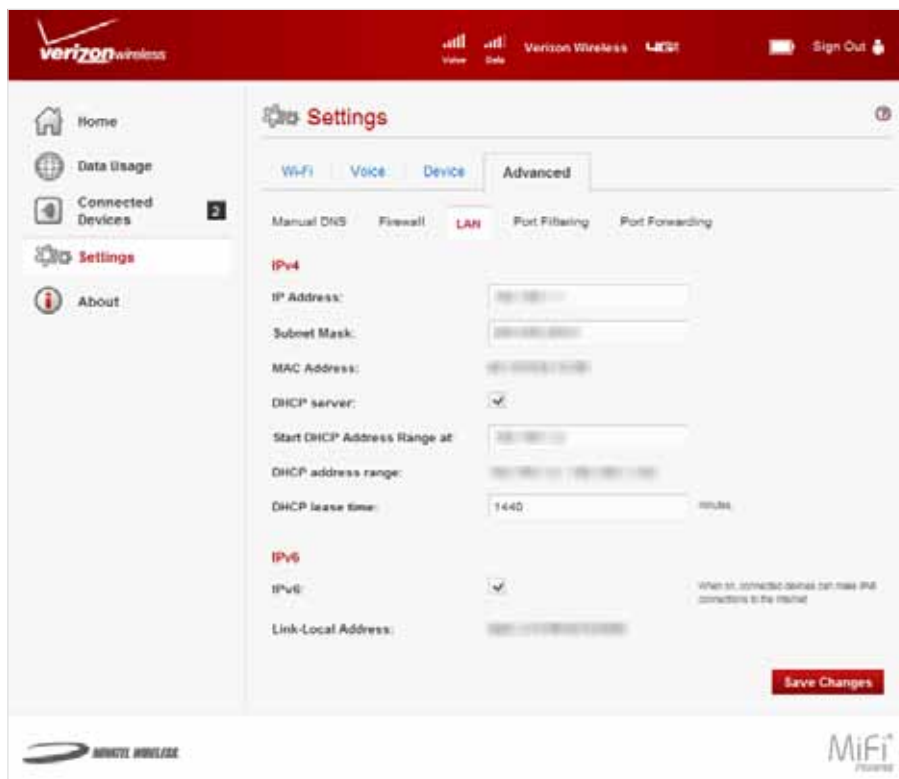

Port Filtering

Port Filtering allows you to block outgoing Internet connections and permit only allowed applications to access the Internet. You can also customize a list of allowed applications which permits only certain programs to connect to the Internet.

Click **ON** to turn on Port Filtering. When the feature is turned on, you must select a port filtering application in the **Applications** list to allow that application to connect to the Internet. For example, if you select VPN in the Applications list but do not select HTTP, you can connect to a VPN server but you cannot connect to a web page using your Internet browser.

Click **OFF** to turn off Port Filtering. When the feature is turned off, any application can connect to the Internet.

The Port Filtering menu contains the following sections:

- **Applications** — Turn on each port filtering application that needs to be able to access the Internet by checking the box next to one or more applications. When port filtering is turned on, all other applications are blocked.
- **Custom Applications** — You can define your own applications, and then turn them on or off as needed. To define an application, you need to know the outgoing ports used by the application.

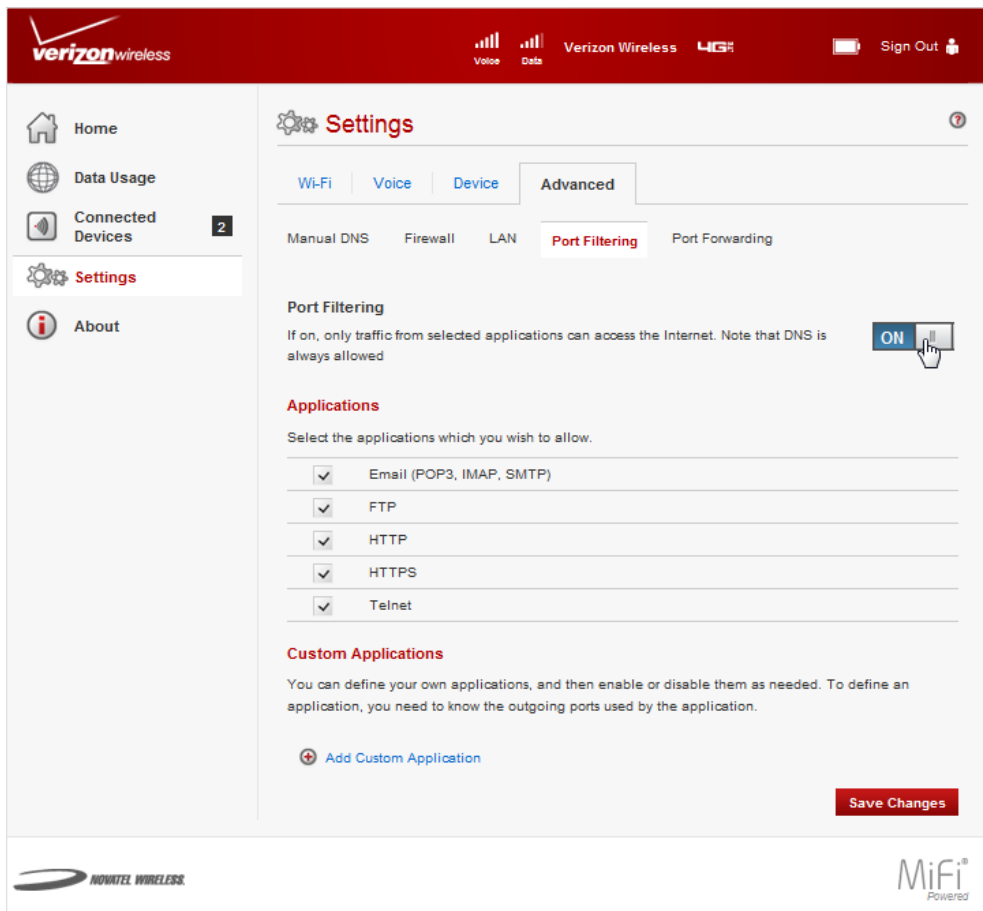

Add a Custom Application

To add a custom application:

- 1 Click **Add Custom Application** to add a new custom application to the list of allowed applications. You can define and turn on custom Port Filtering applications. You need to know details of the traffic used and generated by the applications you wish to define.

NOTE The **Add Custom Application** option is only available when the port filtering is turned on. You can add up to ten custom applications.

The Custom Port Filtering page uses check boxes to turn on port filtering for custom applications. Similar to the Applications list, you must turn on custom applications so they can connect to the Internet.

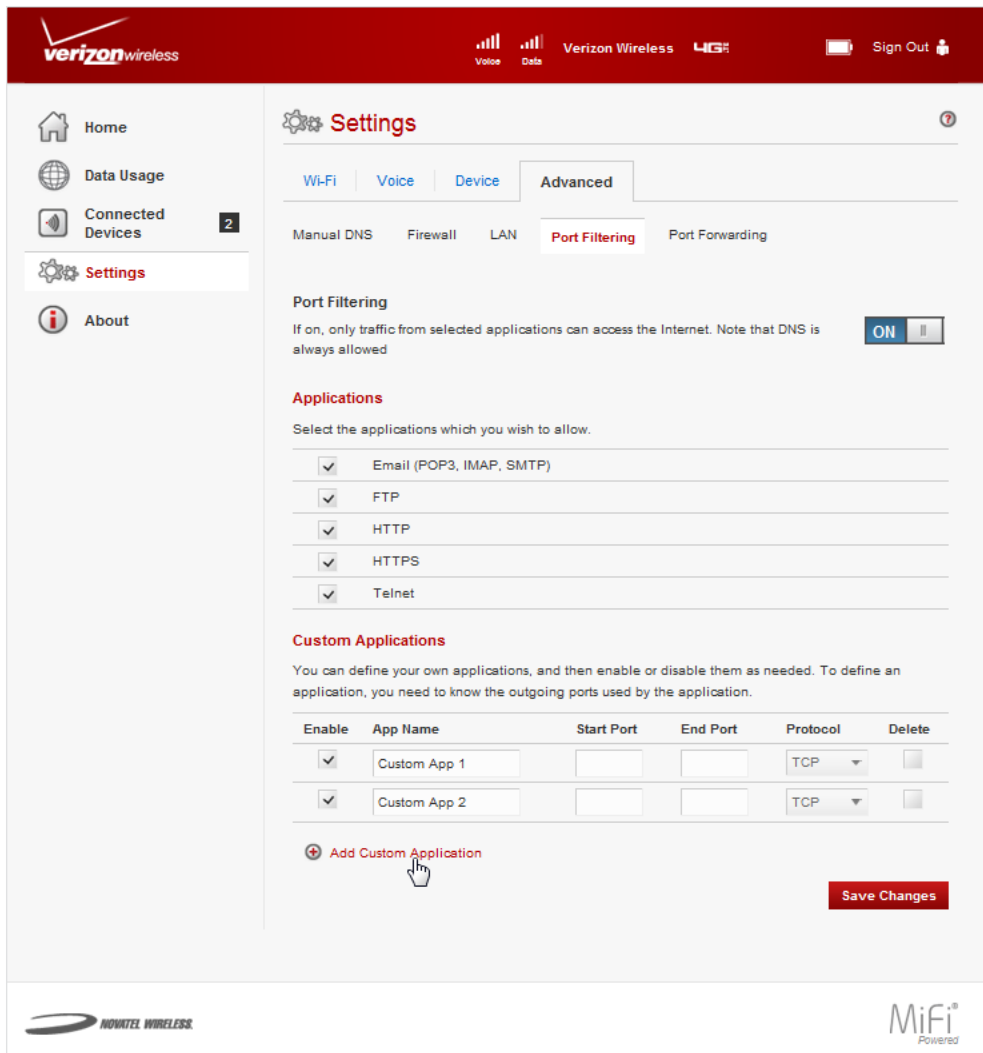

- 2 Enter the beginning of the range of port numbers used by outgoing traffic for the custom application being added in the **Start Port** field.
- 3 Enter the end of the range of port numbers in the **End Port** field. If the port is a single port instead of a range, type the same value for both the **Start Port** and the **End Port**.
- 4 Select the protocol used by each port range from the **Protocol** dropdown menu. Choose from Transmission Control Protocol (TCP), User Datagram Protocol (UDP), or both. Click **Save Changes** to save any changes made to the custom applications.

- 5 Select the **Delete** checkbox next to any custom application you wish to remove and click **Save Changes**.

NOTE Click on the Port Filtering menu tab again to remove deleted custom applications from view on the screen.

Port Forwarding

Port Forwarding allows incoming traffic from the Internet to be forwarded to a particular computer or device on your Wi-Fi network. Normally, the built-in firewall blocks incoming traffic from the Internet. You use Port Forwarding to allow Internet users to access any server you are running on your computer, such as a Web, FTP, or E-mail server.

For some online games, Port Forwarding must be used in order for the games to function correctly. The use of Port Forwarding creates a security risk and should be turned off when not required.

NOTE Some Mobile Wireless Networks provide you with an IP address on their own network rather than an Internet IP address. In this case, Port Forwarding cannot be used because Internet users cannot reach your IP address.

The screenshot shows the Verizon Wireless Mifi Settings interface. At the top, there's a red header with the Verizon logo and 'verizon wireless' text. Below the header, there's a navigation menu on the left with options: Home, Data Usage, Connected Devices (with a notification badge '1'), Settings (highlighted), and About. The main content area is titled 'Settings' and has tabs for 'Wi-Fi', 'Voice', 'Device', and 'Advanced'. Under the 'Advanced' tab, there are sub-tabs for 'Manual DNS', 'Firewall', 'LAN', 'Port Filtering', and 'Port Forwarding'. The 'Port Forwarding' sub-tab is selected and highlighted in red. The 'Port Forwarding' section has a toggle switch set to 'OFF'. Below this, there's a 'Default Applications' section with a list of applications: DNS, FTP, HTTP, POP3, SMTP, SNMP, Telnet, and TFTP. Each application has a checkbox and an input field. At the bottom, there's a 'Custom Applications' section with a link to 'Add a Custom Application' and a 'Save Changes' button.

The Port Forwarding menu contains the following sections:

- **Default Applications** — Turn on each Port Forwarding application that needs to be able to access the Internet by checking the box next to one or more applications.
- **Custom Applications** — You can define your own Port Forwarding applications, and then turn them on or off as needed. To define an application, you need to know the outgoing ports used by the application.

Default Applications

Port Forwarding

Port forwarding sends specific incoming traffic to a connected device. The connected device is specified using its IP address.

Default Applications

<input checked="" type="checkbox"/>	DNS	<input type="text"/>
<input checked="" type="checkbox"/>	FTP	<input type="text"/>
<input checked="" type="checkbox"/>	HTTP	<input type="text"/>
<input checked="" type="checkbox"/>	POP3	<input type="text"/>
<input type="checkbox"/>	SMTP	<input type="text"/>
<input type="checkbox"/>	SNMP	<input type="text"/>
<input type="checkbox"/>	Telnet	<input type="text"/>
<input type="checkbox"/>	TFTP	<input type="text"/>

Custom Applications

You can define your own applications, and then enable or disable them as needed. To define an application, you need to know the incoming ports used by the application.

[+ Add a Custom Application](#)

Save Changes

To turn on Port Forwarding Default Applications:

- 1 Slide the Port Forwarding ON/OFF button to **ON**.
- 2 Install the application on a computer connected to the 4G LTE Broadband Router with Voice's Wi-Fi network.
- 3 On the computer, check its IP address for the Wi-Fi network. Alternatively, you can check the computer's IP address on the Connected Devices screen.
- 4 Enter the computer's IP Address in the Connected Device IP Address field beside the application.
- 5 Turn on this application by selecting its checkbox.
- 6 Click **Save Changes**.
- 7 On the Current Status screen, make a note of the Internet IP address of this device.
- 8 Ask users on the Internet to connect to the Internet IP address of this device. These connection requests will be forwarded to the IP address specified in step 3.

Custom Applications

Port Forwarding Custom Applications allow you to define your own applications. Once defined, these applications can be turned on and off in the same way as pre-defined applications. To define an application, you need to know the ports and protocol (TCP, UDP) used by the application for incoming traffic.

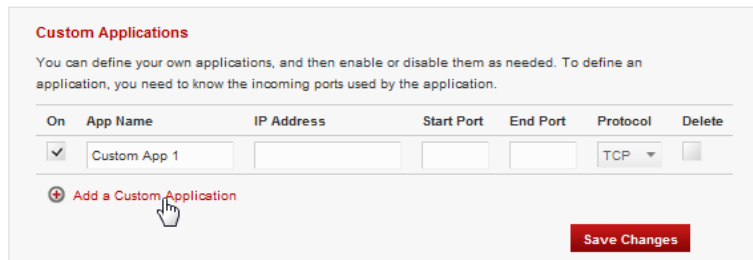

The screenshot shows a web interface titled "Custom Applications". Below the title is a brief instruction: "You can define your own applications, and then enable or disable them as needed. To define an application, you need to know the incoming ports used by the application." Below this is a table with the following columns: "On", "App Name", "IP Address", "Start Port", "End Port", "Protocol", and "Delete". The table contains one row with a checked checkbox in the "On" column, "Custom App 1" in the "App Name" column, empty fields for "IP Address", "Start Port", and "End Port", "TCP" in the "Protocol" column, and a delete icon in the "Delete" column. Below the table is a red button with a plus sign and the text "Add a Custom Application". A mouse cursor is pointing at this button. At the bottom right of the interface is a red "Save Changes" button.

On	App Name	IP Address	Start Port	End Port	Protocol	Delete
<input checked="" type="checkbox"/>	Custom App 1				TCP	

[+ Add a Custom Application](#)

[Save Changes](#)

To add/delete Port Forwarding Custom Applications:

- 1 Click **Add a Custom Application**.
- 2 Enter a suitable name for the application you are adding.
- 3 Enter the beginning and end of the port range for each application. Each application has its own port range.
 - For a single port, enter the port number in both the **Start Port** and **End Port** fields.
 - For a port range, enter the beginning of the range in the **Start Port** field and the end of the range in the **End Port** field.
- 4 For each port range, select the protocol (TCP or UDP) used by that port range from the Protocol dropdown menu.
- 5 Enter the IP address of the connected device which will receive this traffic.
- 6 To remove a Port Filtering Custom Application, check the Delete checkbox for that application.
- 7 Click **Save Changes**.

About

About allows you to view information about your 4G LTE Broadband Router with Voice, including the mobile number, model, IMEI, web interface URL, Admin Password, internet status, device details, diagnostics and logs.

On the 4G LTE Broadband Router with Voice Display

- 1 To view detailed information about your router, press the select button on the Home screen to display the Menu options.
- 2 Use the scroll button to scroll to the **About** icon and press the select button to open the About screen and display your mobile phone, model, and IMEI numbers.
- 3 Select **More > More** to display the Admin screen showing the web interface URL address and Admin Password.

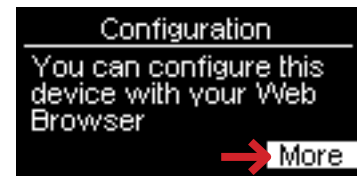

- 4 Select **Close** to return to the Menu options.
- 5 Use the scroll button to scroll to the Home icon, and press Go Home to display the Home page.



On the 4G LTE Broadband Router with Voice Web User Interface

The About page allows you to view detailed information about Internet status, device specific information, diagnostics, troubleshooting and support. The About page contains the following menu options:

- **Internet Status** (See [Internet Status](#) on page 77.)
- **Device Info** (See [Device Info](#) on page 79.)
- **Diagnostics** (See [Diagnostics](#) on page 80.)
- **Logs** (See [Logs](#) on page 84.)
- **Customer Support** (See [Customer Support](#) on page 86.)

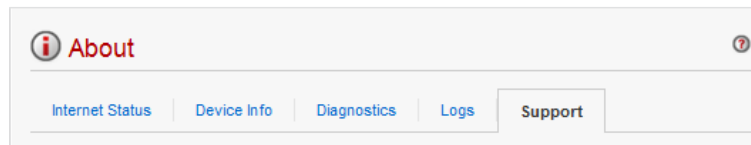

Internet Status

The Internet Status page shows 4G LTE Broadband Router with Voice settings and status and contains the following sections:

- **Internet Status** (See [Internet Status](#) on page 78.)
- **IPv4** (See [IPv4](#) on page 78.)
- **IPv6** (See [IPv6](#) on page 78.)

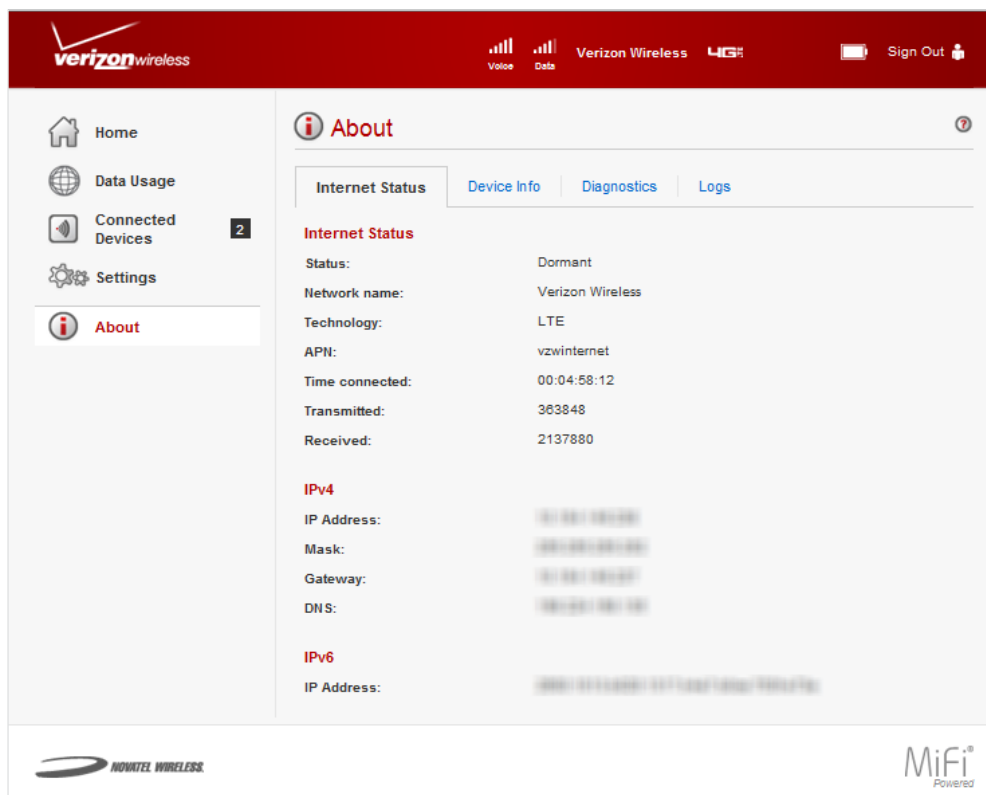

Internet Status

The Internet Status section has the following options:

- **Status** — displays the status of the Internet connection, usually **Connected** or **Disconnected** or **Dormant** if no internet activity is occurring.
- **Network name** — displays the name of the network to which this 4G LTE Broadband Router with Voice is currently connected.
- **Technology** — displays the type of technology used to connect to the Internet.
- **Time connected** — displays the time interval that the 4G LTE Broadband Router with Voice has been connected to the network.
- **Transmitted** — displays the amount of data sent to the network.
- **Received** — displays the amount of data received from the network.

Internet Status	
Status:	Dormant
Network name:	Verizon Wireless
Technology:	None
Time connected:	00:01:29:29
Transmitted:	295.95 KB
Received:	1015.98 KB

IPv4

The IPv4 section has the following options:

- **IP Address** — displays the IP address for the 4G LTE Broadband Router with Voice.
- **Mask** — displays the subnet mask network setting for the 4G LTE Broadband Router with Voice. The default value 255.255.255.0 is standard for small (class "C") networks. If you change the LAN IP Address, ensure you use the correct Subnet Mask for the IP address range containing the LAN IP address.
- **Gateway** — displays the address of the server used to access the Internet.
- **DNS** — displays the address of the Domain Name Server (DNS).

IPv4	
IP address:	10.243.190.37
Mask:	255.255.255.252
Gateway:	10.243.190.38
DNS:	66.174.92.14

IPv6

The IPv6 section has the following option:

- **IP address** — displays the IP address for the 4G LTE Broadband Router with Voice.

IPv6	
IP address	

Device Info

The Device Info page contains detailed information about the 4G LTE Broadband Router with Voice and contains the following sections:

- **Manufacturer** — the manufacturer of the 4G LTE Broadband Router with Voice.
- **Model** — the model number or name of the 4G LTE Broadband Router with Voice.
- **Radio technologies supported** — lists the radio technologies supported for the 4G LTE Broadband Router with Voice
- **IMEI** — International Mobile Equipment Identity for this device.
- **MDN** — Mobile Directory Number (phone number) for this device.
- **Hardware version** — displays the hardware revision number.
- **Software version** — displays the version number of the currently installed software.
 - **OS version** — the Operating System (OS), including its components, version.
 - **Modem FW version** — modem firmware version.
 - **Wi-Fi FW version** — Wi-Fi firmware version.
 - **Web UI version** — web user interface version.
 - **Display UI version** — displays the current user interface version.
 - **PRI version** — displays the configuration version currently applied to the 4G LTE Broadband Router with Voice.

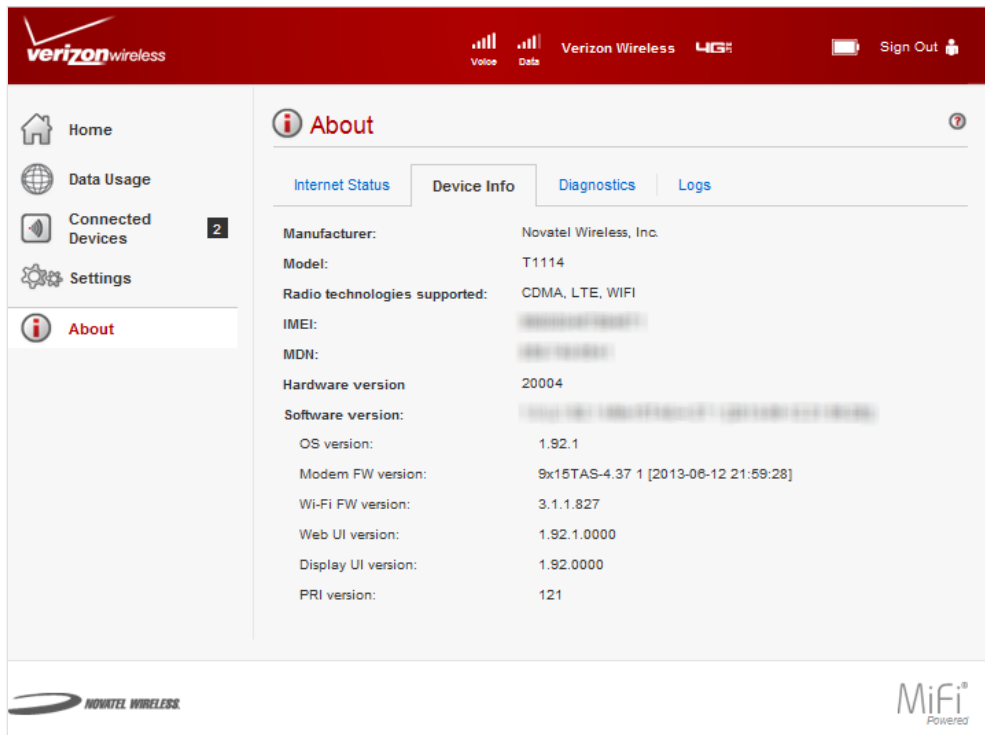

The screenshot shows the Verizon Wireless web interface for a 4G LTE Broadband Router with Voice. The page is titled "About" and displays the following information:

Manufacturer:	Novatel Wireless, Inc.
Model:	T1114
Radio technologies supported:	CDMA, LTE, WIFI
IMEI:	[REDACTED]
MDN:	[REDACTED]
Hardware version:	20004
Software version:	[REDACTED]
OS version:	1.92.1
Modem FW version:	9x15TAS-4.37.1 [2013-06-12 21:59:28]
Wi-Fi FW version:	3.1.1.827
Web UI version:	1.92.1.0000
Display UI version:	1.92.0000
PRI version:	121

The page also features a navigation menu on the left with options: Home, Data Usage, Connected Devices (2), Settings, and About. The Verizon Wireless logo and "MiFi Powered" branding are visible at the bottom.

Diagnostics

The Diagnostics page shows information about the 4G LTE Broadband Router with Voice firmware and other system-level information. You can also view the system log. This page is used mostly for troubleshooting and is not required for normal operation. The Diagnostics page contains the following sections:

- **Modem** (See [Modem](#) on page 81.)
- **4G LTE Network** (See [4G LTE Network](#) on page 82.)
- **1xRTT Network** (See [1xRTT Network](#) on page 82.)
- **Field Test** (See [Field Test](#) on page 83.)

The screenshot displays the Verizon Wireless MiFi Diagnostics page. The top navigation bar includes the Verizon Wireless logo, signal strength indicators for Voice and Data, and a 'Sign Out' button. The left sidebar contains navigation options: Home, Data Usage, Connected Devices (with a notification badge), Settings, and About (selected). The main content area is titled 'About' and has sub-tabs for Internet Status, Device Info, Diagnostics (active), and Logs. A disclaimer states: 'This detailed information is used only for troubleshooting and technical support.' The Diagnostics section is divided into three parts: Modem, 4G LTE Network, and 1xRTT Network. Each part lists various technical specifications and their current values. A 'Field Test' button is located at the bottom of the Diagnostics section. The footer of the page features the Intel Wireless logo on the left and the MiFi Powered logo on the right.

Section	Parameter	Value
Modem	Phone number (MDN):	[REDACTED]
	IMEI:	[REDACTED]
	IMEISV:	[REDACTED]
	FW version:	[REDACTED]
	SIM status:	Ready
	ICCID:	[REDACTED]
	MIN (MSID):	[REDACTED]
	ESN:	[REDACTED]
	Home SID:	4
	ERI version:	5
PRL version:	[REDACTED]	
4G LTE Network	Status:	Available
	Network operator:	[REDACTED]
	Signal strength:	-87 dBm
	SNR:	10
1xRTT Network	Status:	Available
	Network operator:	[REDACTED]
	RSSI:	-80 dBm
	Ec/Io:	-7
	SID:	0

Modem

The Modem section has the following options:

- **Phone number (MDN)** — displays the Phone Number or Mobile Directory Number (MDN) is used by the mobile data network to identify this particular data service.
- **MEID** — displays the Mobile Equipment Identifier (MEID) is used by the mobile data network to identify this particular modem.
- **IMEI** — displays the International Mobile Equipment Identity (IMEI) number for the 4G LTE Broadband Router with Voice.
- **IMEISV** — displays the International Mobile Equipment Identity (IMEI) combined with an approval number for the 4G LTE Broadband Router with Voice.
- **FW version** — displays the modem firmware version.
- **SIM status** — displays the status of the SIM card. If the SIM card is missing, or this field indicates some form of SIM error, the 4G LTE Broadband Router with Voice will not be able to connect to the mobile network.
- **ICCID** — displays the ID number assigned to the SIM Card.
- **MIN (MSID)** — displays the Mobile Identification Number (MIN) or Mobile Station ID (MSID) is the number associated with the home service provider and the wireless phone number.
- **ESN** — displays the Electronic Serial Number, which is either blank or a pseudo-ESN which is not guaranteed to be unique for devices that use an MEID.
- **Home SID** — displays the system identifier for the home network.
- **ERI version** — displays the Enhanced Roaming Indicator version that is currently installed.
- **PRL version** — displays the current version of the Preferred Roaming List (PRL), which tells the modem which non-home carrier towers should provide roaming coverage.

 This detailed information is used only for troubleshooting and technical support.

Modem	
Phone number (MDN):	1234567890
IMEI:	357901234567890
IMEISV:	357901234567890
FW version:	1.0.0.0
SIM status:	Ready
ICCID:	12345678901234567890
MIN (MSID):	1234567890
ESN:	1234567890
Home SID:	4
ERI version:	5
PRL version:	15230

4G LTE Network

The 4G LTE Network section has the following options:

- **Status** — displays status of the network (Disabled, Not available, or Available).
- **Network operator** — displays the vendor that currently provides wireless access.
- **Signal strength** — displays the current signal strength for LTE.
- **SNR** — displays the signal quality; the higher the number the better the signal.

4G LTE Network	
Status:	Available
Network operator:	NEP Wireless
Signal strength:	-87 dBm
SNR:	10

1xRTT Network

The 3G Network (eHRPD/EVDO/1xRTT) section has the following options:

- **Status** — displays the status of the network (Disabled, Not available, or Available).
- **RSSI (1x)** — displays the RSSI for the 1xRTT signal.
- **Ec/Io** — A measure of how clean the signal is, and is a type of signal-to-noise ratio.
- **SID** — System identifier for the network.

1xRTT Network	
Status:	Available
Network operator:	NEP Wireless
RSSI:	-85 dBm
Ec/Io:	-7
SID:	0

Field Test

Click on **Field Test** to provide a list of low-level network parameters which can be helpful for technical support staff when they troubleshoot network connectivity issues.

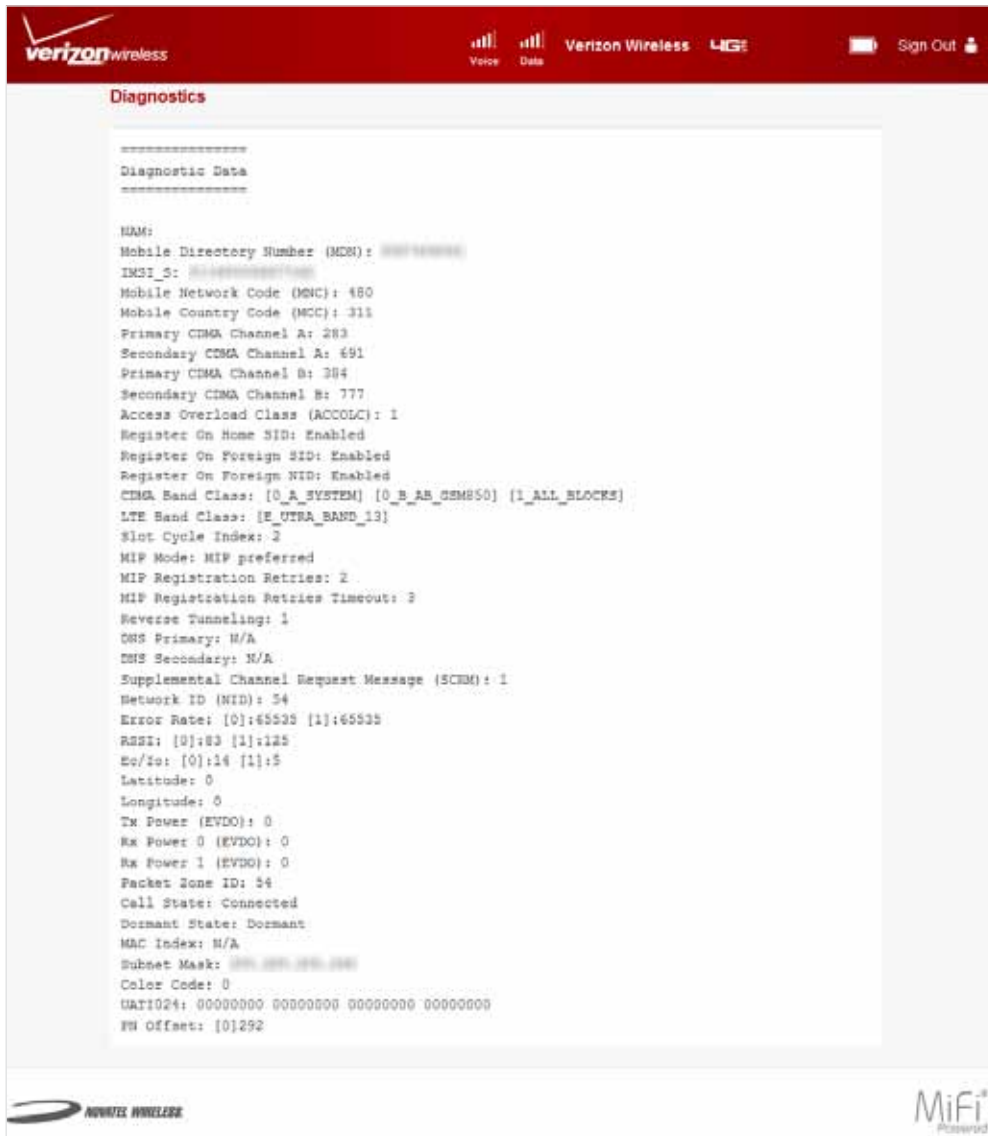

The screenshot shows the Verizon Wireless diagnostics interface. At the top, there is a red header with the Verizon Wireless logo on the left and signal strength, voice, data, and LTE indicators on the right. Below the header, the word "Diagnostics" is centered. The main content area displays a list of diagnostic data in a monospaced font, enclosed in a white box with a thin border. The data includes parameters such as Mobile Directory Number (MDN), IMSI, Mobile Network Code (MNC), Mobile Country Code (MCC), Primary and Secondary CDMA Channels, Access Overload Class (ACCOLC), Register On Home and Foreign SIMs, Register On Foreign NID, CDMA Band Class, LTE Band Class, Slot Cycle Index, MIP Mode, MIP Registration Retries and Timeout, Reverse Tunneling, DNS Primary and Secondary, Supplemental Channel Request Message (SCRM), Network ID (NID), Error Rate, RSSI, Ec/Io, Latitude, Longitude, Tx Power (EVDO), Rx Power 0 and 1 (EVDO), Packet Zone ID, Call State, Dormant State, MAC Index, Subnet Mask, Color Code, UATI024, and PN Offset.

```
=====
Diagnostic Data
=====

NAM:
Mobile Directory Number (MDN): 800765555
IMSI_S: 310000000000000
Mobile Network Code (MNC): 480
Mobile Country Code (MCC): 310
Primary CDMA Channel A: 283
Secondary CDMA Channel A: 691
Primary CDMA Channel B: 384
Secondary CDMA Channel B: 777
Access Overload Class (ACCOLC): 1
Register On Home SIM: Enabled
Register On Foreign SIM: Enabled
Register On Foreign NID: Enabled
CDMA Band Class: [0_A_SYSTEM] [0_B_AB_GSM850] [1_ALL_BLOCKS]
LTE Band Class: [E_UTRA_BAND_13]
Slot Cycle Index: 2
MIP Mode: MIP preferred
MIP Registration Retries: 2
MIP Registration Retries Timeout: 2
Reverse Tunneling: 1
DNS Primary: N/A
DNS Secondary: N/A
Supplemental Channel Request Message (SCRM): 1
Network ID (NID): 54
Error Rate: [0]:65535 [1]:65535
RSSI: [0]:83 [1]:125
Ec/Io: [0]:14 [1]:5
Latitude: 0
Longitude: 0
Tx Power (EVDO): 0
Rx Power 0 (EVDO): 0
Rx Power 1 (EVDO): 0
Packet Zone ID: 54
Call State: Connected
Dormant State: Dormant
MAC Index: N/A
Subnet Mask: 255.255.255.255
Color Code: 0
UATI024: 00000000 00000000 00000000 00000000
PN Offset: [0]292
```

At the bottom of the page, there is a Verizon Wireless logo on the left and a MiFi Password logo on the right.

Logs

The Logs page allows you to turn logging on or off, and to delete system logs.

NOTE Logs record various operations and are used for troubleshooting and are not needed for normal 4G LTE Broadband Router with Voice operation.

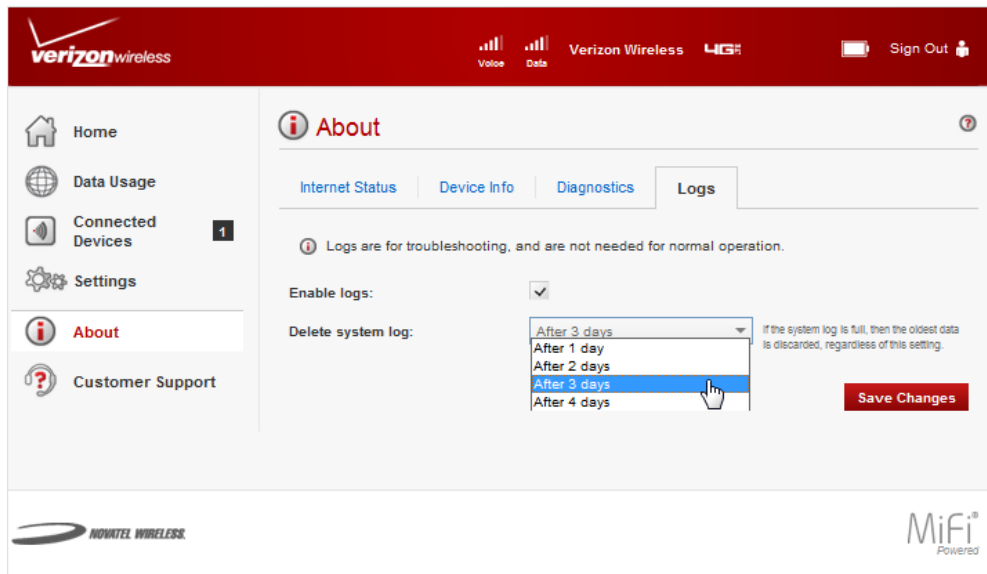

Enable System Logs

To turn on system logs, follow these steps:

- 1 Select the checkbox next to **Enable logs**.

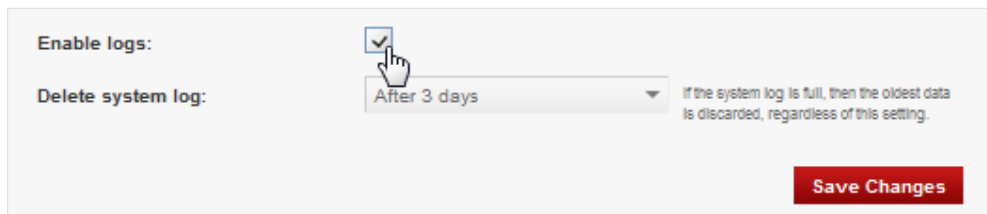

- 2 Click **Save Changes**.

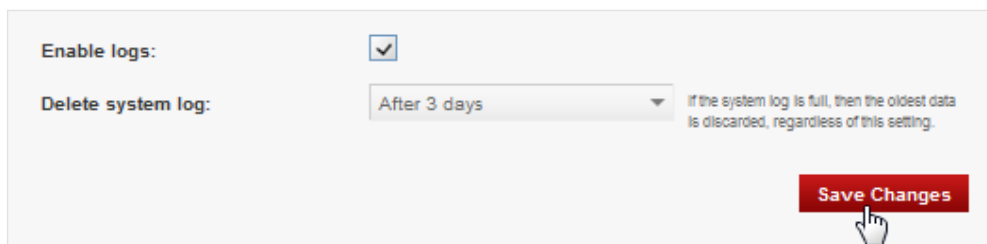

Disable System Logs

To turn off system logs, follow these steps:

- 1 Deselect the checkbox next to **Enable logs**.

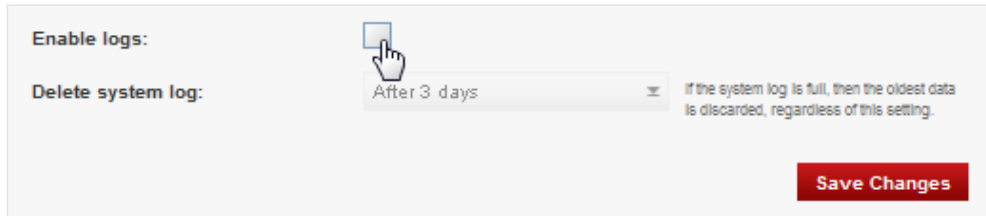

Enable logs:

Delete system log: After 3 days

If the system log is full, then the oldest data is discarded, regardless of this setting.

Save Changes

- 2 Click **Save Changes**.

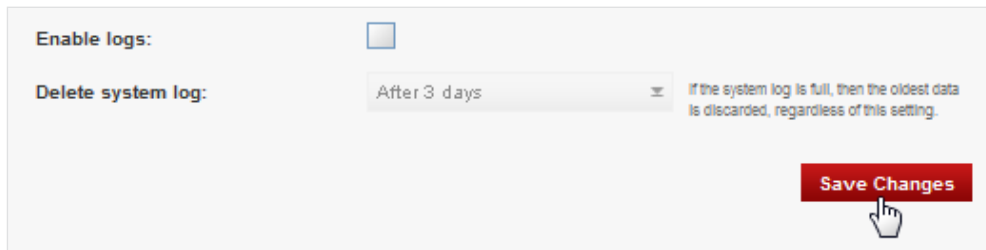

Enable logs:

Delete system log: After 3 days

If the system log is full, then the oldest data is discarded, regardless of this setting.

Save Changes

Delete System Log

To delete a system log, follow these steps:

- 1 Select the checkbox next to **Enable logs**.

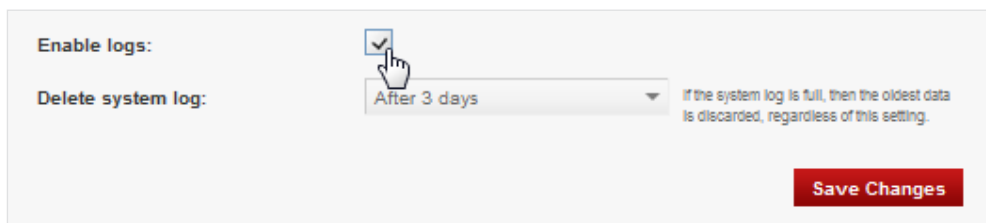

Enable logs:

Delete system log: After 3 days

If the system log is full, then the oldest data is discarded, regardless of this setting.

Save Changes

- 2 Select the appropriate time period for the removal of system logs from the dropdown menu next to **Delete system log**.

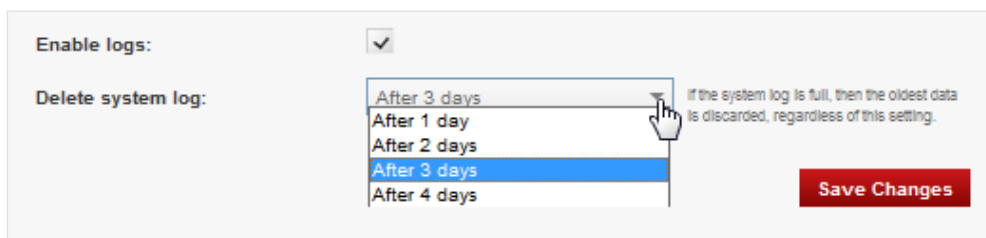

Enable logs:

Delete system log: After 3 days

If the system log is full, then the oldest data is discarded, regardless of this setting.

Save Changes

- 3 Click **Save Changes**.

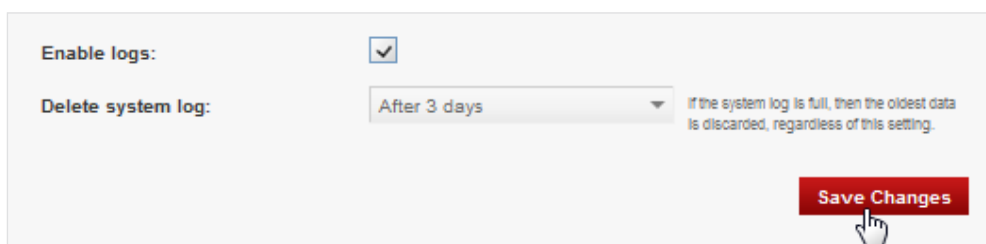

Enable logs:

Delete system log: After 3 days

If the system log is full, then the oldest data is discarded, regardless of this setting.

Save Changes

Customer Support

The Customer Support page contains the following sections:

- **Quick Links** (See [Quick Links](#) on page 86.)
- **Self-Serve Support** (See [Self-Serve Support](#) on page 87.)
- **Customer Care** (See [Customer Care](#) on page 87.)

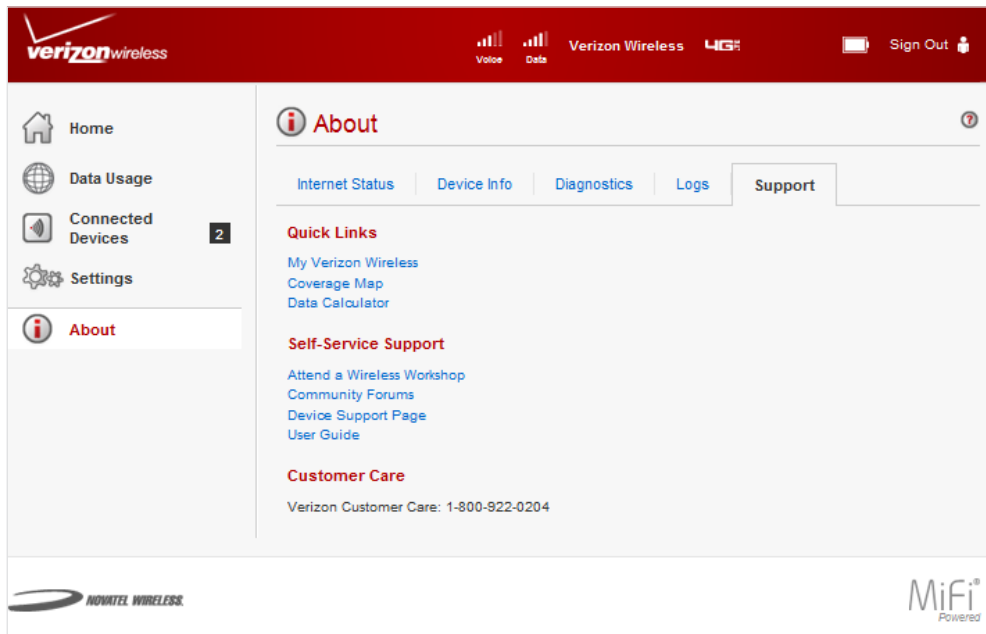

Quick Links

The Quick Links section has the following options:

- **My Verizon Wireless** — **My Verizon Wireless** allows you to manage your account, pay your bill, purchase accessories and more. Click on **My Verizon Wireless** to register or go to www.verizonwireless.com/myverizon.
- **Coverage Map** — displays the Verizon Wireless coverage area. Also available using **Home > My Account & Tools** on the 4G LTE Broadband Router with Voice Web User Interface.
- **Data Calculator** — calculate your data usage and select the best plan to meet your data requirements. Also available using **Home > My Account & Tools** on the 4G LTE Broadband Router with Voice Web User Interface.

Self-Serve Support

The Self-Serve Support section has the following options:

- **Attend a Wireless Workshop**— click on **Attend a Wireless Workshop** to attend a free Wireless Workshop online or in a store to learn everything you need to know about your 4G LTE Broadband Router with Voice. (You can also open your browser and type <https://vzwworkshops.verizonwireless.com/vzwworkshops/>.)
- **Community Forums** — click on **Community Forums** to follow, share and participate in the Broadband & Netbook Community. In addition, you can search Broadband & Netbook Community discussions for specific topics. (You can also open your browser and type <https://community.verizonwireless.com/community/broadband>.)
- **Device Support Page** — click on **Device Support Page** to join and discuss the latest news in Verizon Wireless products, services, and more. (You can also open your browser and type <https://community.verizonwireless.com/welcome>.)
- **User Guide** — click on **User Guide** to access an online version of the 4G LTE Broadband Router with Voice User Guide. (You can also open your browser and type <http://VerizonBRV/Customer Care>.)

Customer Care

Verizon Customer Care: 1.800.922.0204

4

Troubleshooting

Overview
Common Problems and Solutions
Technical Support

Overview

When properly installed, the 4G LTE Broadband Router with Voice is a highly reliable product. Most problems are caused by one of these issues:

- Phones or ethernet devices connected to incorrect ports. Please refer to the labels next to the ports for proper connections.
- Network coverage is unavailable due to coverage area, an account problem, or a network problem. To display a Verizon Wireless coverage map, see [Verizon Wireless Coverage map](#).

The following tips can help solve many common problems encountered while using the 4G LTE Broadband Router with Voice.

First Steps

- Make sure you are using the 4G LTE Broadband Router with Voice in the correct geographic region.
- Ensure that your wireless coverage extends to your current location.
- If you do not receive a strong voice or data signal, move the device to a different location.
- Ensure you have an active subscription plan.
- Restarting your computer and your 4G LTE Broadband Router with Voice can resolve many issues.

IMPORTANT Before contacting support, be sure to restart both your computer and your 4G LTE Broadband Router with Voice.

Common Problems and Solutions

The following are some common problems and solutions.

Why am I not getting a dial tone on my handset?

- Ensure that the power adaptor is properly connected and that the power indicator is illuminated.
- Check to make sure the telephone cable is securely plugged in.
- Check to make sure you are not roaming outside of the Verizon Wireless network.

Can I create a shortcut to access my voice mail?

The availability of a shortcut feature to access voice mail messages depends solely on the capabilities of the corded or cordless phone that you use with the 4G LTE Broadband Router with Voice. Please refer to the user material that came with your phone.

If your home phone does not support a shortcut feature to access voice messages, you may have the option to save your voice mail number into the address book on the handset and assign that number to the #1 speed dial position on your phone's keypad. Remember, you can always dial *86 to access your voice mail.

Can I use my telephone answering device instead of voice mail?

Yes. Set the answering device to fewer rings in order to pick up the call before Verizon Wireless voice mail. Alternatively, turn off your home answering machine or increase the number of rings if you would like to use the Verizon Wireless voice mail service. Please refer to the user material provided by the home answering machine manufacturer for instructions.

Does 911 work on this device?

Yes, but since the 4G LTE Broadband Router with Voice is designed for an indoor environment, please be prepared to provide your location inside the premises to public service personnel. The GPS chipset embedded in this device will work best if the device is located near a window or other opening.

Does the 4G LTE Broadband Router with Voice work during a power outage?

While the 4G LTE Broadband Router with Voice has a backup battery, if the landline device requires external power to operate, service (including the ability to make and receive E911 calls) will not be available during a power outage. Service will only be available during a power outage if the home telephone connected to the device does not rely on external power to operate (as is the case with many corded phones).

Only voice service will be available during a power outage. Data service will not be available.

How long is the backup battery life of the 4G LTE Broadband Router with Voice?

Talk usage time on backup battery is approximately 4 hours and standby time is approximately 33 hours. Internet connectivity is disabled to preserve talk time when in backup battery mode. Actual values can vary with environmental conditions.*

How does Caller ID (CID) work?

CID allows you to see the caller's name and/or phone number before you take the call. Monthly subscription charges may apply. Please consult your carrier for further information.

Can I adjust the volume on my telephone?

You can adjust the volume using your telephone connected to the 4G LTE Broadband Router with Voice. Four volume levels are available, with level 1 being the softest and level 4 the loudest. The default setting is level 4.

- 1 Take the phone off the hook so you can hear the dial tone and verify that telephone service is available.
- 2 Press ## to adjust the volume.
- 3 Press keys 1 to 4 to select the desired volume.
- 4 After selecting the desired volume, press the * key to save it. If you hear a single confirmation tone, you have successfully set the volume level.

NOTE If you hear a double tone you have pressed an incorrect key. The system will return to the off-hook state, and you can try adjusting the volume again when you hear the dial tone.

Why do I get the recording, "Call cannot be completed as dialed?"

Check the number to ensure you're dialing correctly, without pauses longer than two seconds between dialed digits. If you require more than two seconds between dialed digits, you can change the time interval setting using the Web User Interface at <http://verizonbrv/>

How do I reset the Wi-Fi and Router settings back to factory settings?

To reset the Wi-Fi and router settings:

- 1 Connect to 4G LTE Broadband Router with Voice. Open a web browser on the connected device and enter <http://VerizonBRV/> or <http://192.168.1.1> in your browser.
- 2 Open the 4G LTE Broadband Router with Voice Backup and Restore page after Signing In to the Web User Interface. (See [Backup and Restore](#) on page <?>.) The Backup and Restore page has a **Restore to Factory Defaults** button. This button resets all Wi-Fi and Router settings to their factory default values. All existing settings are lost.

* If the router is disconnected from AC power and running on the battery alone, only voice calls are supported. A phone that does not require separate electric power is required to place or receive calls (including 911) during a power outage.

How do I reset the 4G LTE Broadband Router with Voice back to factory settings?

The master reset button is in a small hole located on the bottom of the 4G LTE Broadband Router with Voice battery cover. This button returns the device to factory settings, including resetting the Wi-Fi Name (SSID) and Password and Admin Password.

To reset the 4G LTE Broadband Router with Voice:

- 1 Place one end of an unfolded paper clip into the master reset button hole.
- 2 Press the paper clip on the button until the display shows "Verizon Powering Off" (about five to six seconds), then your 4G LTE Broadband Router with Voice will restart.



WARNING! The "Reset to Factory Defaults" operation overwrites ALL existing settings. If the Wi-Fi settings change, you will lose this connection, and need to reconnect using the new settings.

Technical Support

IMPORTANT Before contacting support, be sure to re-start both your computer and the 4G LTE Broadband Router with Voice and perform the trouble shooting steps in this guide.

Technical Support

For additional information and technical support, visit any Verizon Wireless store, the online support page at <http://Verizonwireless.com/support>, or contact Customer Service at **1-800-922-0204** if additional help is required.

Product Specifications and Regulatory Information

Product Specifications
Regulatory Information
Wireless Communications
Limited Warranty and Liability
Safety Hazards
Proper Battery Use and Disposal

Product Specifications

General

Name:	Verizon 4G LTE Broadband Router with Voice
Model:	T1114
Standards/Approvals/Certifications:	FCC (North America)/RoHS
Weight:	420 g / 14.8 oz
Dimensions:	138.2 mm x 80.2 mm x 173.3 mm, 5.44 in x 3.16 in x 6.8 in
Wireless Network	LTE, CDMA 1xRTT
Wireless Network – Wi-Fi Mode	802.11 a/b/g/n
Default SSID	Verizon-4GLTE-BRV-XXXX
Battery	
• Size	2150 mAh
• Time required for full charge	2.5 - 3 hours (when not in use)
Chip Set:	QUALCOMM® MDM9615
Interface Types:	Ethernet (3)/Phone (RJ-11 (2)/Optional external antenna (2)
LED:	Power, Wi-Fi, LAN, WPS, WWAN
GPS:	A-GPS for E911 only

Technology/Bands

Technology:	4G LTE, CDMA
Band Designation:	4G LTE: B4 (700 MHz)/B13 (1700/2100 MHz) CDMA 1xRTT: 800/1900 MHz
LTE Transmit Band:	746-763 MHz/1720-1755 MHz
LTE Receive Band:	776-793 MHz/2110-2155 MHz
CDMA Transmit Band:	824.7-848.31 MHz/1851.25-1908.75 MHz
CDMA Receive Band:	869.7-893.31 MHz/1931.25-1988.75 MHz

Environmental

Operating Temperature:	-10 °C to +55° C (14°F to 131° F)
Storage Temperature:	-40 °C to +85° C (-40°F to 185° F)
Drop:	1 meter (3.28 feet) drop, no damage – fully operational
Vibration Stability:	5 Hz to 500 Hz, 0.1 octave/second

Regulatory Information

FEDERAL COMMUNICATIONS COMMISSION NOTICE (FCC - UNITED STATES)

Electronic devices, including computers and wireless modems, generate RF energy incidental to their intended function and are therefore subject to FCC rules and regulations.

This equipment has been tested to, and found to be within the acceptable limits for a Class B digital device, pursuant to part 15 of the FCC Rules. These limits are designed to provide reasonable protection against harmful interference when the equipment is operated in a residential environment.

This equipment generates radio frequency energy and is designed for use in accordance with the manufacturer's user manual. However, there is no guarantee that interference will not occur in any particular installation. If this equipment causes harmful interference to radio or television reception, which can be determined by turning the equipment off and on, you are encouraged to try to correct the interference by one or more of the following measures.

- Reorient or relocate the receiving antenna.
- Increase the separation between the equipment and the receiver.
- Connect the equipment into an outlet on a circuit different from that to which the receiver is connected.
- Consult the dealer or an experienced radio/television technician for help.

This device complies with Part 15 of the Federal Communications Commission (FCC) Rules for EMI compliance. Operation is subject to the following two conditions:

1. This device may not cause harmful interference.
2. This device must accept any interference received, including interference that may cause undesired operation.

WARNING: DO NOT ATTEMPT TO SERVICE THE WIRELESS COMMUNICATION DEVICE YOURSELF. SUCH ACTION MAY VOID THE WARRANTY. THE T1114 IS FACTORY TUNED. NO CUSTOMER CALIBRATION OR TUNING IS REQUIRED. CONTACT NOVATEL WIRELESS, INC. TECHNICAL SUPPORT FOR INFORMATION ABOUT SERVICING YOUR WIRELESS COMMUNICATION DEVICE.

FCC CAUTION: Any changes or modification not expressly approved by the party responsible for compliance could void the user's authority to operate this equipment.

MODIFICATIONS: The FCC requires that you be notified that any changes or modifications made to this device that are not expressly approved by Novatel Wireless may void your authority to operate the equipment.

NOTE: The Radio Frequency (RF) emitter installed in your modem must not be located or operated in conjunction with any other antenna or transmitter, unless specifically authorized by Novatel Wireless Technologies.

RF Exposure Content

FCC Equipment Authorization ID: PKRNVWT1114

This device is authorized for use in mobile applications. At least 20 cm (8 in) of separation between the router and the user's body must be maintained at all times.



Wireless Communications

IMPORTANT Due to the transmission and reception properties of wireless communications, data occasionally can be lost or delayed.

This can be due to the variation in radio signal strength that results from changes in the characteristics of the radio transmission path. Although data loss is rare, the environment where you operate the modem might adversely affect communications.

Variations in radio signal strength are referred to as fading. Fading is caused by several different factors including signal reflection, the ionosphere, and interference from other radio channels.

Novatel Wireless or its partners will not be held responsible for damages of any kind resulting from the delays or errors in data transmitted or received with the Verizon 4G LTE Broadband Router with Voice device, or failure of the Verizon 4G LTE Broadband Router with Voice device to transmit or receive such data.

Limited Warranty and Liability

Novatel Wireless, Inc. warrants for the 12-month period immediately following receipt of the Product by Purchaser that the Product will be free from defects in material and workmanship under normal use. THESE WARRANTIES ARE EXPRESSLY IN LIEU OF ALL OTHER WARRANTIES, EXPRESS OR IMPLIED, INCLUDING, WITHOUT LIMITATION, ALL IMPLIED WARRANTIES OF MERCHANTABILITY AND FITNESS FOR A PARTICULAR PURPOSE.

The exclusive remedy for a claim under this warranty shall be limited to the repair or replacement, at Novatel Wireless' option, of defective or non-conforming materials, parts or components. The foregoing warranties do not extend to (I) non conformities, defects or errors in the Products due to accident, abuse, misuse or negligent use of the Products or use in other than a normal and customary manner, environmental conditions not conforming to Novatel Wireless' specification, of failure to follow prescribed installation, operating and maintenance procedures, (II) defects, errors or nonconformities in the Product due to modifications, alterations, additions or changes not made in accordance with Novatel Wireless' specifications or authorized by Novatel Wireless, (III) normal wear and tear, (IV) damage caused by force of nature or act of any third person, (V) shipping damage, (VI) service or repair of Product by the purchaser without prior written consent from Novatel Wireless, (VII) products designated by Novatel Wireless as beta site test samples, experimental, developmental, reproduction, sample, incomplete or out of specification Products, or (VIII) returned products if the original identification marks have been removed or altered.

Safety Hazards

Do not operate the Verizon 4G LTE Broadband Router with Voice in an environment that might be susceptible to radio interference resulting in danger, specifically:

Areas where prohibited by the law

Follow any special rules and regulations and obey all signs and notices. Always turn off the host device when instructed to do so, or when you suspect that it might cause interference or danger.

Where explosive atmospheres might be present

Do not operate your device in any area where a potentially explosive atmosphere might exist. Sparks in such areas could cause an explosion or fire resulting in bodily injury or even death. Be aware and comply with all signs and instructions.

Users are advised not to operate the device while at a refueling point or service station. Users are reminded to observe restrictions on the use of radio equipment in fuel depots (fuel storage and distribution areas), chemical plants or where blasting operations are in progress.

Areas with a potentially explosive atmosphere are often but not always clearly marked. Potential locations can include gas stations, below deck on boats, chemical transfer or storage facilities, vehicles using liquefied petroleum gas (such as propane or butane), areas where the air contains chemicals or particles, such as grain, dust or metal powders, and any other area where you would normally be advised to turn off your vehicle engine.

Near medical and life support equipment

Do not operate your device in any area where medical equipment, life support equipment, or near any equipment that might be susceptible to any form of radio interference. In such areas, the host communications device must be turned off. The device can transmit signals that could interfere with this equipment.

On an aircraft, either on the ground or airborne

In addition to FAA requirements, many airline regulations state that you must suspend wireless operations before boarding an airplane. Please ensure that the modem is turned off prior to boarding aircraft in order to comply with these regulations. The modem can transmit signals that could interfere with various onboard systems and controls.

While operating a vehicle

The driver or operator of any vehicle should not operate a wireless data device while in control of a vehicle. Doing so will detract from the driver or operator's control and operation of that vehicle. In some countries, operating such communications devices while in control of a vehicle is an offense.

Electrostatic discharge (ESD)

Electrical and electronic devices are sensitive to electrostatic discharge (ESD). Macintosh native connection software might attempt to reinitialize the device should a substantial electrostatic discharge reset the device. If the software is not operational after an ESD occurrence, then restart your computer.

Proper Battery Use and Disposal

IMPORTANT In event of a battery leak:

- Do not allow the liquid to come in contact with the skin or the eyes. If contact has been made, wash the affected area with large amounts of water and seek medical advice.
 - Seek medical advice immediately if a battery has been swallowed.
 - Communicate the appropriate steps to be taken if a hazard occurs. Due to the transmission and reception properties of wireless communications, data occasionally can be lost or delayed.
-

Please review the following guidelines for safe and responsible battery use.

- Do not disassemble or open, crush, bend or deform, puncture, or shred.
- Do not modify or remanufacture, attempt to insert a foreign object into the battery, immerse or expose to water or other liquids, or expose to fire, explosion, or other hazard.
- Only use the battery for the system for which it was specified.
- Only use the battery with a charging system that has been qualified with the system per this standard. Use of an unqualified battery or charger may present a risk of fire, explosion, leakage, or other hazard.
- Do not short circuit a battery or allow a metallic or conductive object to contact the battery terminals.
- Replace the battery only with another battery that has been qualified with the system per this standard. Use of an unqualified battery may present a risk of fire, explosion, leakage, or other hazard.
- Promptly dispose of used batteries in accordance with local regulations.
- Battery usage by children should be supervised.
- Avoid dropping the 4G LTE Broadband Router with Voice or battery. If the 4G LTE Broadband Router with Voice or the battery is dropped, especially on a hard surface, and the user suspects damage, take it to a service center for inspection.
- Improper battery use may result in a fire, explosion, or other hazard.

Glossary

Glossary

- **1X** — The core CDMA2000 wireless air interface standard. The designation "1X", meaning 1 times Radio Transmissio Technology, indicates the same radio frequency (RF) bandwidth as IS-95: a duplex pair of 1.25 MHz channels. The 1X standard supports packet data speeds of up to 153 kbit/s with real world data transmission averaging 80-100 kbit/s in most commercial applications.
- **3G** — Third Generation. 3G refers to the third generation of mobile telephony technology. 3G telecommunication networks support services that provide an information transfer rate of at least 200 kbit/s. However, many services advertised as 3G provide higher speed than the minimum technical requirements for a 3G service. 3G finds application in wireless voice telephony, mobile Internet access, fixed wireless Internet access, video calls and mobile TV.
- **4G LTE** — Fourth Generation Long Term Evolution. LTE is a standard for wireless data communications technology and an evolution of the GSM/UMTS standards. The goal of LTE is to increase the capacity and speed of wireless data networks using new DSP (digital signal processing) techniques and modulations that were developed around the turn of the millenium. A further goal is the redesign and simplification of the network architecture to an IP-based system with significantly reduced transfer latency compared to the 3G architecture. The LTE wireless interface is incompatible with 2G and 3G networks, so that it must be operated on a separate wireless spectrum.
- **802.11 (b, g, n)** — A set of WLAN Wi-Fi communication standards in the 2.4, 3.6 and 5 GHz frequency bands.
- **bps** — Bits per second. The rate of data flow.
- **Broadband** — High-capacity high-speed transmission channel with a wider bandwidth than conventional modem lines. Broadband channels can carry video, voice, and data simultaneously.
- **CDMA** — Code Division Multiple Access. It is the underlying channel access method used by some mobile phone standards.
- **DHCP** — Dynamic Host Configuration Protocol. Software found in servers and routers that automatically assigns IP addresses and other configuration data to computers, tablets, printers, and other devices connected to the IP network.
- **DHCP Server** — A server or service with a server that assigns IP addresses.
- **DNS** — Domain Name System. A system for converting host names and domain names into IP addresses on the Internet or on local networks that use the TCP/IP protocol.
- **EV-DO Rev 0** — CDMA EV-DO Rev. 0 is a leading-edge 3G wireless technology with higher data rates and higher system capacity. It is a fully backward compatible standard and remains interoperable with deployed EV-DO networks and devices around the world. Rev 0 provides access to mobile devices with forward link speeds of up to 2.4 Mbit/s, and reverse link speeds up to 152 kbit/s. For more information, visit www.cdg.org.

- **EV-DO Rev A** — CDMA EV-DO Rev. A is a leading-edge 3G wireless technology with higher data rates and higher system capacity. It is a fully backward compatible standard and remains interoperable with deployed EV-DO networks and devices around the world. Rev A provides access to mobile devices with forward link speed of up to 3.1 Mbit/s, and reverse link speeds up to 1.8 Mbit/s. The increased data rates on Rev. A's physical layer enable richer applications and services. For more information, visit www.cdg.org.
- **Firmware** — A computer program embedded in an electronic device. Firmware usually contains operating code for the device.
- **GB** — Gigabyte. A multiple of the unit byte for digital information storage. Usage depends on context. When referring to disk capacities it usually means 10^9 bytes. It also applies to data transmission quantities over telecommunication circuits.
- **Hotspot** — A Wi-Fi (802.11) access point or the area covered by an access point. Used for connecting to the Internet.
- **HTTP** — Hypertext Transfer Protocol. An application-level protocol for accessing the World Wide Web over the Internet.
- **IEEE** — Institute of Electrical and Electronics Engineers. An international technical/professional society that promotes standardization in technical disciplines.
- **IMEI** — International Mobile Equipment Identity. Used in LTE networks to identify the device. It is usually printed on the device and can often be retrieved using a USSD code.
- **IP** — Internet Protocol. The mechanism by which packets are routed between computers on a network.
- **IP Type** — The type of service provided over a network.
- **IP address** — Internet Protocol address. The address of a device attached to an IP network (TCP/IP network).
- **ISP** — Internet Service Provider. Also referred to as the service carrier, an ISP provides Internet connection service. (*See* Network Operator)
- **Kbps** — Kilobits per second. The rate of data flow.
- **LAN** — Local Area Network. A type of network that lets a group of computers, all in close proximity (such as inside an office building), communicate with one another. It does not use common carrier circuits though it can have gateways or bridges to other public or private networks.
- **MAC Address** — Media Access Control. A number that uniquely identifies each network hardware device. MAC addresses are 12-digit hexadecimal numbers. This is also known as the physical or hardware address.
- **Mbps** — Megabits per second. The rate of data flow.
- **MSID** — Mobile Station IDentifier. A number for a mobile phone that identifies that phone to the network. These numbers are carrier specific.
- **Network Operator** — The vendor who provides your wireless access. Known by different names in different regions, some examples are: wireless provider, network provider, and service provider.
- **Network Technology** — The technology on which a particular network provider's system is built; such as CDMA or EVDO.

- **Port** — A virtual data connection used by programs to exchange data. It is the endpoint in a logical connection. The port is specified by the port number.
- **Port Forwarding** — A process that allows remote devices to connect to a specific computer within a private LAN.
- **Port Number** — A 16-bit number used by the TCP and UDP protocols to direct traffic on a TCP/IP host. Certain port numbers are standard for common applications.
- **PRL** — Preferred Roaming List. A list that your wireless phone or device uses to determine which networks to connect with when you are roaming. (Network operator specific).
- **Protocol** — A standard that enables connection, communication, and data transfer between computing endpoints.
- **Proxy** — A firewall mechanism that replaces the IP address of a host on the internal (protected) network with its own IP address for all traffic passing through it.
- **Router** — A device that directs traffic from one network to another.
- **SIM** — Subscriber Identification Module. Found in LTE and GSM network technology, the SIM is a card containing identification information for the subscriber and their account. The SIM card can be moved to different devices.
- **SSID** — Service Set Identifier. The name assigned to a Wi-Fi network.
- **TCP/IP** — Transmission Control Protocol/Internet Protocol. The set of communications protocols used for the Internet and other similar networks.
- **TTY** — Text Telephones (TTY), also known as Telecommunications Device for the Deaf (TDD), are used by the deaf, hard-of-hearing, and individuals with speech impairments to communicate.
- **UDP** — User Datagram Protocol (UDP) is a communications protocol that offers a limited amount of service when messages are exchanged between computers in a network that uses the Internet Protocol (IP). UDP is an alternative to the Transmission Control Protocol (TCP) and, together with IP, is sometimes referred to as UDP/IP.
- **USB** — Universal Serial Bus. A connection type for computing device peripherals such as a printer, mobile modem, etc. USB connectors may be used for data transfer or charging.
- **USB Port Types** — The USB ports on computers and hubs have a rectangular Type A socket, and peripheral devices have a cable with a Type A plug. Peripherals that do not have an attached cable have a square Type B socket on the device and a separate cable with a Type A and Type B plug. Ports and connectors are available in different sizes (for example, standard, mini, and micro).
- **VPN** — Virtual Private Network. A secure private network that runs over the public Internet. Commonly used to connect to an office network from elsewhere.
- **WCDMA** — Wideband Code Division Multiple Access. An air interface standard found in 3G mobile telecommunications networks. The most-commonly used member of the UMTS family.
- **Wi-Fi** — Wireless Fidelity. Any system that uses the 802.11 standard developed and released in 1997 by the IEEE.
- **Wi-Fi Client** — A wireless device that connects to the Internet via Wi-Fi.
- **WPA/WPA2** — Wi-Fi Protected Access. A security protocol for wireless 802.11 networks from the Wi-Fi Alliance.