

# User's Guide

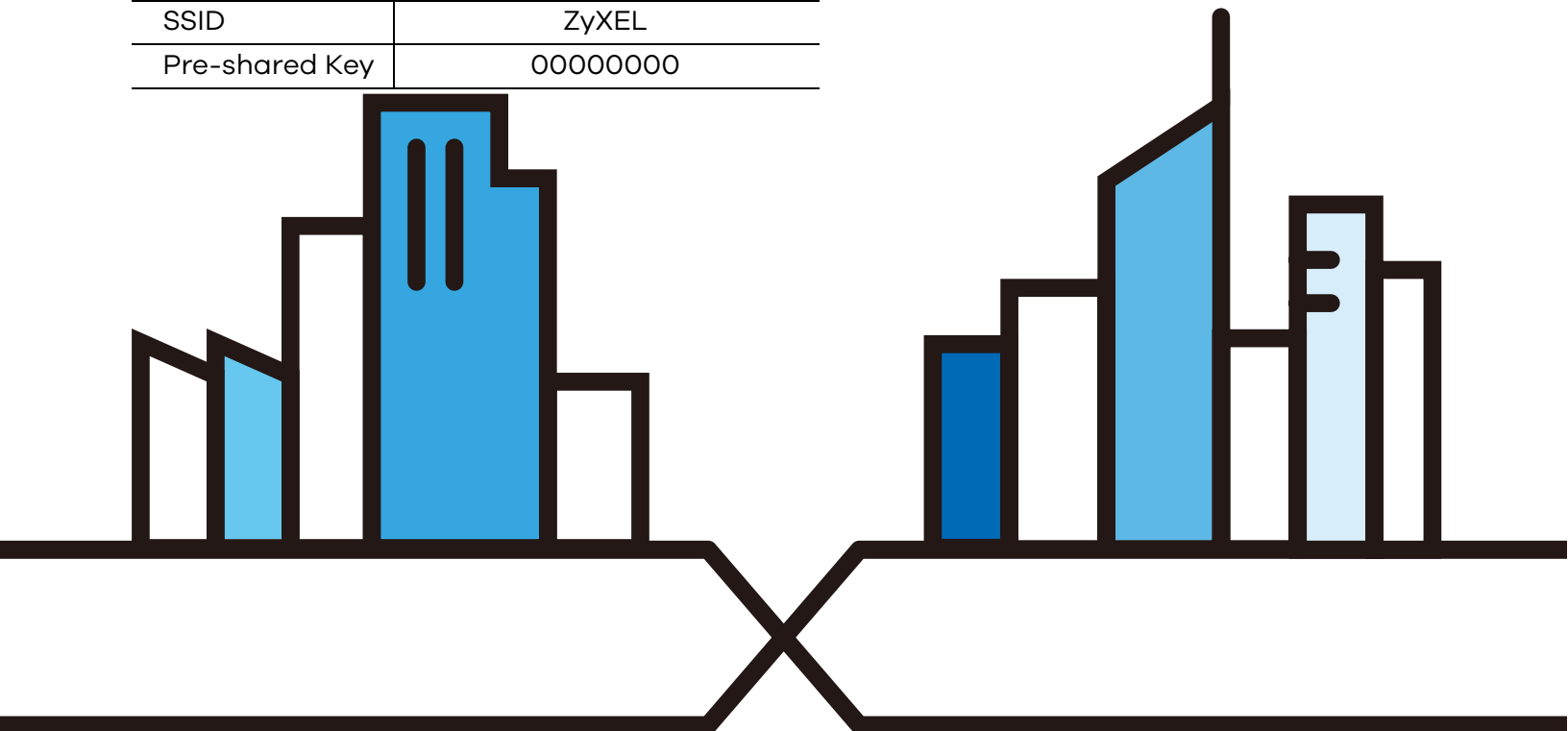
## WRE2206

Wireless N300 Range Extender

### Default Login Details

Web Address	http://zyxelsetup (Windows) OR http://zyxelsetup.local (Mac)
LAN IP Address	http://192.168.1.2
User Name	admin
Password	1234
SSID	ZyXEL
Pre-shared Key	00000000

Version 1.00 Edition 2, 06/2018



---

**IMPORTANT!**

**READ CAREFULLY BEFORE USE.**

**KEEP THIS GUIDE FOR FUTURE REFERENCE.**

This is a User's Guide for a system managing a series of products. Not all products support all features. Menushots and graphics in this book may differ slightly from what you see due to differences in release versions or your computer operating system. Every effort has been made to ensure that the information in this manual is accurate.

### **Related Documentation**

- Quick Start Guide

The Quick Start Guide shows how to connect the managed device, such as the Nebula AP, gateway or security gateway.

- More Information

Go to [support.zyxel.com](http://support.zyxel.com) to find other information on the WRE2206.



# Contents Overview

<b>User's Guide</b> .....	<b>7</b>
Introduction .....	8
The Web Configurator .....	12
Connection Wizard .....	14
Status .....	20
Tutorials .....	24
<b>Technical Reference</b> .....	<b>34</b>
Wireless LAN .....	35
LAN .....	44
System .....	46
Tools .....	47
Troubleshooting .....	53

---

# Table of Contents

<b>Contents Overview .....</b>	<b>3</b>
<b>Table of Contents .....</b>	<b>4</b>
<b>Part I: User's Guide.....</b>	<b>7</b>
<b>Chapter 1</b>	
<b>Introduction.....</b>	<b>8</b>
1.1 Overview .....	8
1.2 Securing the WRE2206 .....	9
1.3 Front Panel .....	9
1.4 The WPS Button .....	10
1.4.1 WiFi Protected Setup .....	11
<b>Chapter 2</b>	
<b>The Web Configurator.....</b>	<b>12</b>
2.1 Overview .....	12
2.2 Accessing the Web Configurator .....	12
2.3 Resetting the WRE2206 .....	13
<b>Chapter 3</b>	
<b>Connection Wizard.....</b>	<b>14</b>
3.1 Overview .....	14
3.2 Configuring the WRE2206 for Connection to an AP .....	14
3.2.1 Selecting Automatically Detected AP Parameters .....	14
3.2.2 Manually Configuring AP Parameters .....	16
3.3 Completing the Connection Wizard .....	17
<b>Chapter 4</b>	
<b>Status.....</b>	<b>20</b>
4.1 WRE2206 Status .....	20
4.2 Navigation Panel .....	22
<b>Chapter 5</b>	
<b>Tutorials.....</b>	<b>24</b>
5.1 Overview .....	24
5.2 Connecting a Wireless Client using WPS .....	24
5.2.1 Push Button Configuration (PBC) .....	24

5.2.2 PIN Configuration .....	26
5.3 Connecting the WRE2206 to an AP .....	27
5.3.1 Connecting to an AP with the WPS PBC Method .....	28
5.3.2 Connecting to an AP with the WPS PIN Method .....	29
5.3.3 Selecting an AP from an Automatically Detected List .....	30
5.3.4 Selecting an AP by Manually Entering Security Information .....	32
<b>Part II: Technical Reference.....</b>	<b>34</b>
<b>Chapter 6</b>	
<b>Wireless LAN .....</b>	<b>35</b>
6.1 Overview .....	35
6.2 What You Can Do .....	35
6.3 What You Should Know .....	35
6.3.1 Wireless Security Overview .....	36
6.4 General Wireless LAN Screen .....	37
6.5 MAC Address List .....	38
6.6 Wireless LAN Advanced Screen .....	39
6.7 Quality of Service (QoS) Screen .....	40
6.8 WPS Screen .....	40
6.9 WPS Station Screen .....	41
6.10 AP Select Screen .....	42
<b>Chapter 7</b>	
<b>LAN .....</b>	<b>44</b>
7.1 Overview .....	44
7.2 What You Need To Know .....	44
7.3 LAN IP Screen .....	44
<b>Chapter 8</b>	
<b>System.....</b>	<b>46</b>
8.1 Overview .....	46
8.2 What You Can Do .....	46
8.3 System Password Screen .....	46
<b>Chapter 9</b>	
<b>Tools .....</b>	<b>47</b>
9.1 Overview .....	47
9.2 What You Can Do .....	47
9.3 Firmware Upload Screen .....	47
9.4 Configuration Screen .....	49

9.4.1 Backup Configuration .....	50
9.4.2 Restore Configuration .....	50
9.4.3 Back to Factory Defaults .....	51
9.5 Restart Screen .....	51
9.6 LED Screen .....	51
<b>Chapter 10</b>	
<b>Troubleshooting.....</b>	<b>53</b>
10.1 Power, Hardware Connections, and LEDs .....	53
10.2 WRE2206 Access and Login .....	54
10.3 Internet Access .....	55
10.4 Resetting the WRE2206 to Its Factory Defaults .....	56
10.5 Wireless Problems .....	57
Appendix A Customer Support .....	58
Appendix B Legal Information.....	64
<b>Index .....</b>	<b>71</b>

---

# PART I

## User's Guide

---

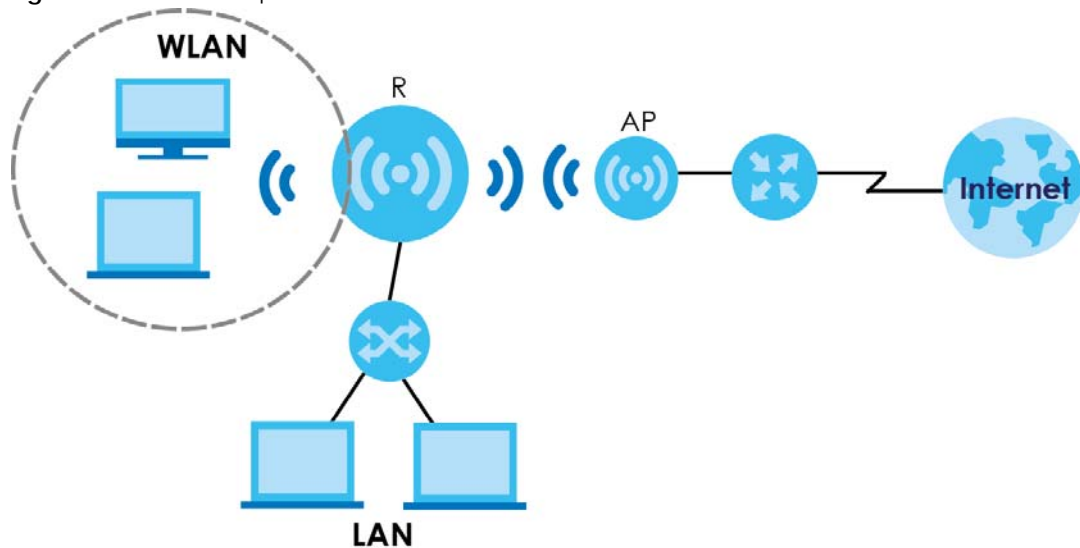
# CHAPTER 1

## Introduction

### 1.1 Overview

The WRE2206 (N) is a universal repeater that is an access point and a wireless client at the same time. The WRE2206 (N) wirelessly relays communications from its wireless clients to the access point.

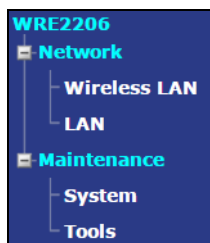
Figure 1 Universal Repeater



You can create the following connections using the WRE2206:

- **LAN.** You can connect network devices via the Ethernet port of the WRE2206 (R) so that they can communicate with each other and access the Internet.
- **WLAN.** Wireless clients can connect to the WRE2206 (R) to access network resources.

Use a (supported) web browser to manage the WRE2206.



See [Chapter 4 on page 20](#) for more information.



## 1.2 Securing the WRE2206

Do the following things regularly to make the WRE2206 more secure and to manage the WRE2206 more effectively.

- Change the password. Use a password that's not easy to guess and that consists of different types of characters, such as numbers and letters.
- Write down the password and put it in a safe place.
- Back up the configuration (and make sure you know how to restore it). Restoring an earlier working configuration may be useful if the device becomes unstable or even crashes. If you forget your password, you will have to reset the WRE2206 to its factory default settings. If you backed up an earlier configuration file, you would not have to totally re-configure the WRE2206. You could simply restore your last configuration.




## 1.3 Front Panel

Figure 2 Front Panel



The following table describes the LEDs and the WPS button.

Table 1 Front Panel LEDs and WPS Button

LED	STATUS	DESCRIPTION
	3 LED On	The signal strength is 50-100%.
	2 LED On	The signal strength is 25-50%.
	1 LED On	The signal strength is <25%. The WRE2206 is in the process of starting up.
	Off	No signal detected, disconnected or the LED is turned off in the firmware.
	1 LED On	The number of wireless clients connecting to the WRE2206 is greater than or equal to ten.
	2 LED On	The number of wireless clients connecting to the WRE2206 is greater than or equal to five, but less than ten.
	3 LED On	The number of wireless clients connecting to the WRE2206 is greater than or equal to one, but less than five. The WRE2206 is in the process of starting up.
	Off	The wireless LAN is not ready. The number of wireless clients connecting to the WRE2206 is zero.
	On	This remains on for 5 minutes after a successful WPS connection has been established.
	Blinking Slowly	The WRE2206 is waiting for another WPS device to connect. The WRE2206 is in the process of starting up, rebooting or resetting.
	Blinking Rapidly	The WRE2206 fails to connect to a router or AP using WPS.
	Off	There is no WPS connection established or a WPS connection has been established for more than five minutes, or the LED is turned off in the firmware.

## 1.4 The WPS Button

The WPS button can be used to begin WiFi Protected Setup (WPS), reboot the WRE2206 while keeping its configuration or reboot the WRE2206 to factory default configuration.

Table 2 WPS Button Functions

ACTION	RESULT
Hold for less than 5 seconds	The WRE2206 begins connecting to an AP via WPS. See <a href="#">Section 5.3 on page 27</a> .
Push twice	The WRE2206 begins connecting to a wireless client via WPS. See <a href="#">Section 5.2 on page 24</a> .
Hold for 5 to 10 seconds	The WRE2206 keeps its configuration and reboots.
Hold for more than 10 seconds	The WRE2206 resets its configuration to factory defaults and reboots. See <a href="#">Section 2.3 on page 13</a> .
Push three times	Push three times to turn off the WPS LED. After turning off the LED, the WRE2206 disconnects the connection to a wireless client via WPS and returns to the normal state.  The physical WPS button has priority over the WPS button in the Web Configurator.

## 1.4.1 WiFi Protected Setup

Your WRE2206 supports Wi-Fi Protected Setup (WPS), which is an easy way to set up a secure wireless network. WPS is an industry standard specification, defined by the WiFi Alliance.

WPS allows you to quickly set up a wireless network with strong security, without having to configure security settings manually. Each WPS connection works between two devices. Both devices must support WPS (check each device's documentation to make sure).

Depending on the devices you have, you can either press a button (recommended) on the device itself, or in its configuration utility or enter a PIN (a unique Personal Identification Number that allows one device to authenticate the other) in each of the two devices. When WPS is activated on a device, it has two minutes to find another device that also has WPS activated. Then, the two devices connect and set up a secure network by themselves.

For more information on using WPS, see [Section 5.2 on page 24](#).

# CHAPTER 2

## The Web Configurator

### 2.1 Overview

This chapter describes how to access the WRE2206 Web Configurator and provides an overview of its screens.

The Web Configurator is an HTML-based management interface that allows easy setup and management of the WRE2206 via Internet browser. Use Internet Explorer 6.0 and later versions, Mozilla Firefox 3 and later versions, or Safari 2.0 and later versions. The recommended screen resolution is 1024 by 768 pixels.

In order to use the Web Configurator you need to allow:

- Web browser pop-up windows from your device. Web pop-up blocking is enabled by default in Windows XP SP (Service Pack) 2.
- JavaScript (enabled by default).
- Java permissions (enabled by default).

Refer to [Chapter 10 Troubleshooting](#) to see how to make sure these functions are allowed in Internet Explorer.

### 2.2 Accessing the Web Configurator

- 1 Make sure your WRE2206 hardware is properly connected and prepare your computer or computer network to connect to the WRE2206 (refer to the Quick Start Guide).

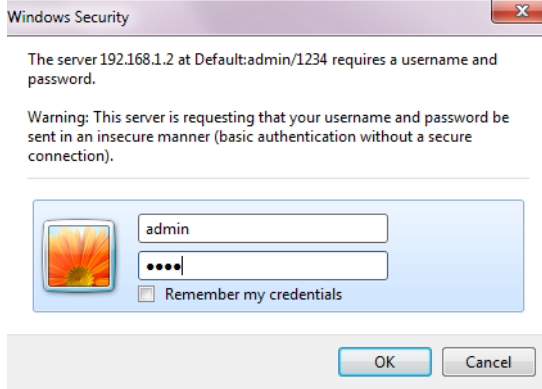
Note: Your computer or the part of your network connected to the WRE2206 must be on the same subnet as the WRE2206.

The WRE2206's DHCP server is enabled before the WRE2206 is associated with your AP or wireless router and disabled after association. If this is the first time you are accessing your WRE2206, you can configure your computer as a DHCP client (computer factory default) so it will get an IP address automatically from the WRE2206. After the WRE2206 is associated with your wireless router, your computer will get its IP address from the wireless router.

- 2 Launch your web browser.
- 3 If this is the first time you are accessing your WRE2206, type "http://192.168.1.2" as the website address in your web browser. This is the default LAN IP address. Alternatively, after the WRE2206 has successfully associated with your wireless router, type "http://zyxelsetup" (for Windows) or "http://zyxelsetup.local" (for Mac) instead of the default IP address.

- 4 Type **admin** (default) as the user name and **1234** (default) as the password and click **OK**.

**Figure 3** Login Screen



## 2.3 Resetting the WRE2206

If you forget your password or IP address, or you cannot access the Web Configurator, press the **WPS** button for more than 10 seconds to reload the factory-default configuration file. This means that you will lose all configurations that you had previously saved, the username will be reset to **admin** and password will be reset to **1234**. The IP address will be reset to "192.168.1.2".


- 1 Press and hold the **WPS** button, the WPS LED begins flashing immediately.
- 2 Release the **WPS** button. The WRE2206 reloads factory defaults and begins to reboot.

# CHAPTER 3

## Connection Wizard

### 3.1 Overview

This chapter provides information on the wizard setup screens in the Web Configurator.

The Web Configurator's wizard setup helps you configure your device. The first time you access the WRE2206 Web Configurator, the wizard displays automatically. For subsequent access, click  to start the wizard setup.

### 3.2 Configuring the WRE2206 for Connection to an AP

In this step of the configuration wizard, you must configure the WRE2206 with the security parameters of the AP you want to connect to. These parameters can be configured by selecting those automatically detected by the WRE2206, or by configuring them manually. Manual configuration is useful when the AP is hidden.

#### 3.2.1 Selecting Automatically Detected AP Parameters

- 1 Select an AP using the following screen.

Figure 4 Wizard: Wireless Setup



The following table describes the labels in this screen.

Table 3 Network &gt; Wireless LAN &gt; AP Select

LABEL	DESCRIPTION
Select	Use the radio button to select the wireless device to which you want to connect.
SSID	This displays the Service Set IDentity of the wireless device. The SSID is a unique name that identifies a wireless network. All devices in a wireless network must use the same SSID.
MAC	This displays the MAC address of the wireless device.
Channel	This displays the channel number used by this wireless device.
Mode	This displays which IEEE 802.11b/g/n wireless networking standards the wireless device supports.
Security Mode	This displays the type of security configured on the wireless device. When <b>no</b> is shown, no security is configured and you can connect to it without a password.
Strength	This displays the strength of the wireless signal. The signal strength mainly depends on the antenna output power and the distance between your WRE2206 and this device.
Enter SSID manually	Select this to setup the AP manually.
SSID	If <b>Enter SSID manually</b> is selected, use this field to type the SSID of the AP. This is useful when the AP's SSID is hidden.
Refresh	Click this to search for available wireless devices within transmission range and update this table.
BACK	Click this to go back to the previous step in the wizard.
NEXT	Click this to start the next step in the AP setup process.
EXIT	Click this to exit the wizard.
Previous	Click this to see the previous page of APs.
Next	Click this to see the next page of APs.

Note: The wireless stations and WRE2206 must use the same SSID, channel ID, WPA-PSK (if WPA-PSK is enabled) or WPA2-PSK (if WPA2-PSK is enabled) for wireless communication.

- 2 Type a key. The number of characters accepted by the KEY field is shown in the following table.

Table 4 Maximum Key Lengths

ENCRYPTION	KEY FORMAT	KEY LENGTH
64-bit WEP	ASCII	5 characters
	Hex	10 characters
128-bit WEP	ASCII	13 characters
	Hex	26 characters
WPA pre-shared key	Passphrase	8-63 characters
	Hex	64 characters

Figure 5 Wizard: Type a Key

eaZy 123

• Wireless Setup

1

Please enter your wireless network's password

KEY :

BACK NEXT EXIT

ZYXEL

### 3.2.2 Manually Configuring AP Parameters

If the AP you want to connect to is not listed, then follow these steps to configure the security settings of the AP manually.

- 1 Select **Enter SSID manually**.
- 2 Type the SSID of the AP into the **SSID** field.

Figure 6 Wizard: Manually Typing the SSID

eaZy 123

• Wireless Setup

1

Select	SSID	MAC	Channel	Mode	Security Mode	Strength
1 <input type="radio"/>	Google WIFI	08:9e:08:ef:bf:6a	6	bgn	WPA2-PSK	100% <input type="text"/>
2 <input type="radio"/>	Google WIFI-guest	0a:9e:08:ef:bf:68	6	bgn	WPA2-PSK	100% <input type="text"/>
3 <input type="radio"/>	ZyXEL_Wi-Fi	b0:b2:dc:70:c0:24	6	bgn	WPA2-PSK	100% <input type="text"/>
4 <input type="radio"/>	eero	14:22:db:2e:4c:06	1	bgn	WPA2-PSK	86% <input type="text"/>
5 <input type="radio"/>	ADHBU_24G	60:31:97:33:a7:74	11	bgn	WPA2-PSK	82% <input type="text"/>

Enter SSID manually

SSID : testap

Previous 1/11 Next

Refresh NEXT EXIT

ZYXEL

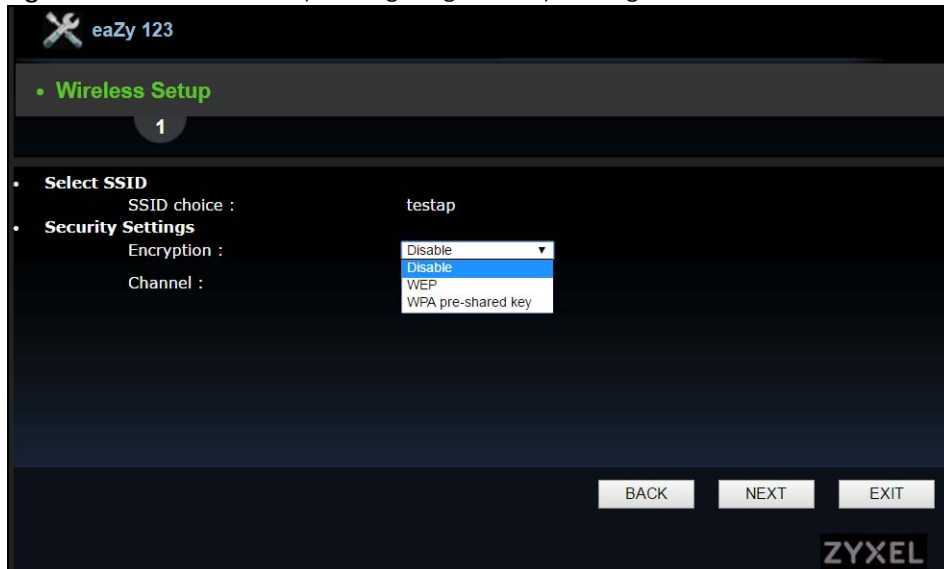
- 3 Configure the security settings. The number of characters accepted by the KEY field is shown in the following table.



Table 5 Maximum Key Lengths

ENCRYPTION	KEY FORMAT	KEY LENGTH
64-bit WEP	ASCII	5 characters
	Hex	10 characters
128-bit WEP	ASCII	13 characters
	Hex	26 characters
WPA pre-shared key	Passphrase	8-63 characters
	Hex	64 characters

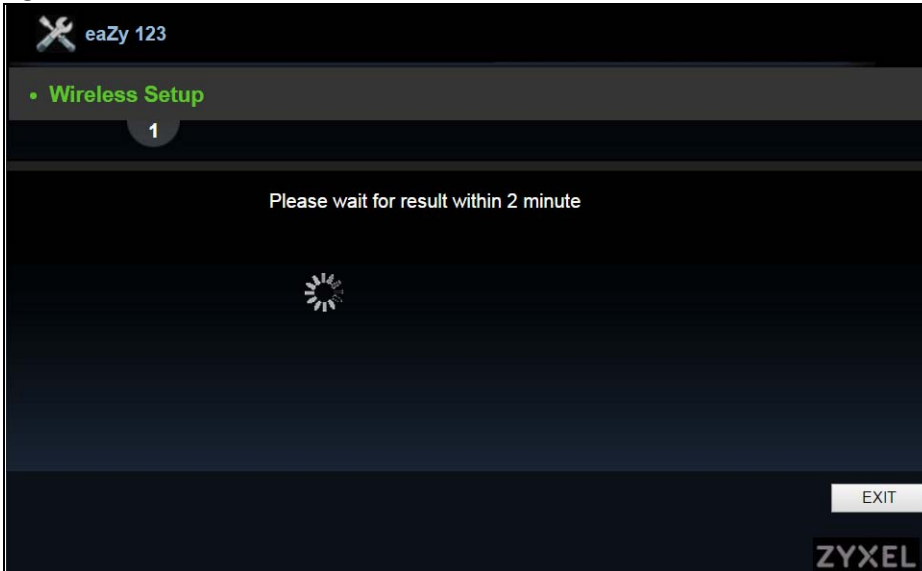
Figure 7 Wizard: Manually Configuring Security Settings



### 3.3 Completing the Connection Wizard

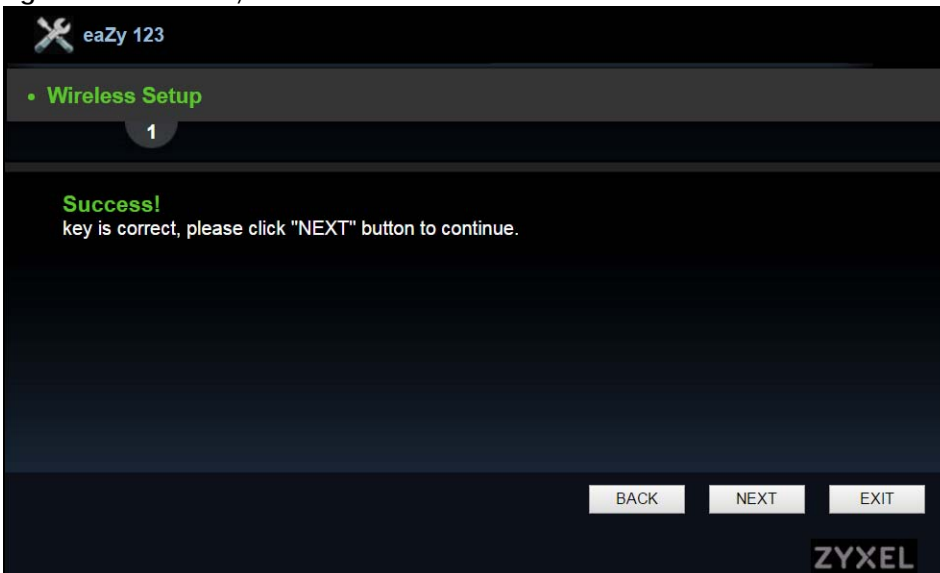
- 1 Click **Next**. The key verification screen appears.

Figure 8 Wizard: Verifying the Key



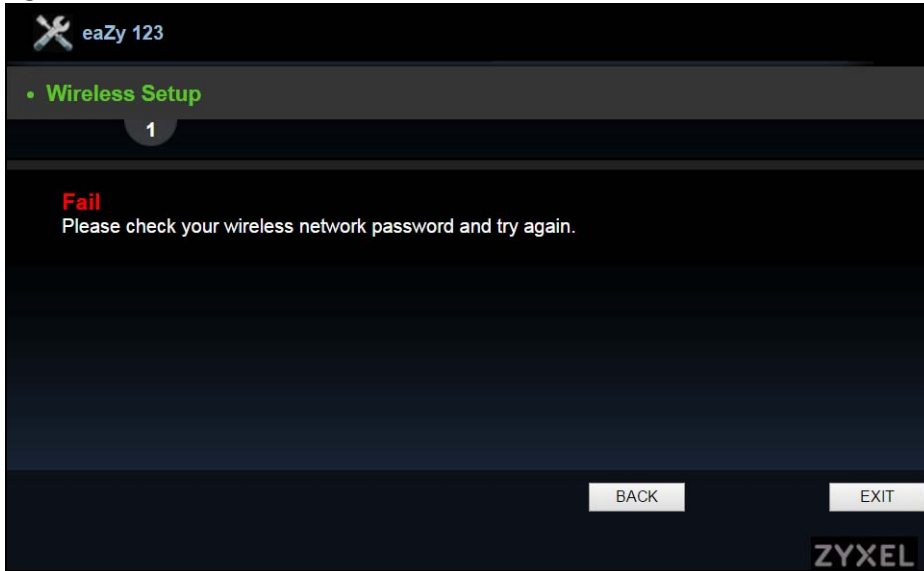
The following screen appears if the key verifies successfully.

Figure 9 Wizard: Key Verification Success



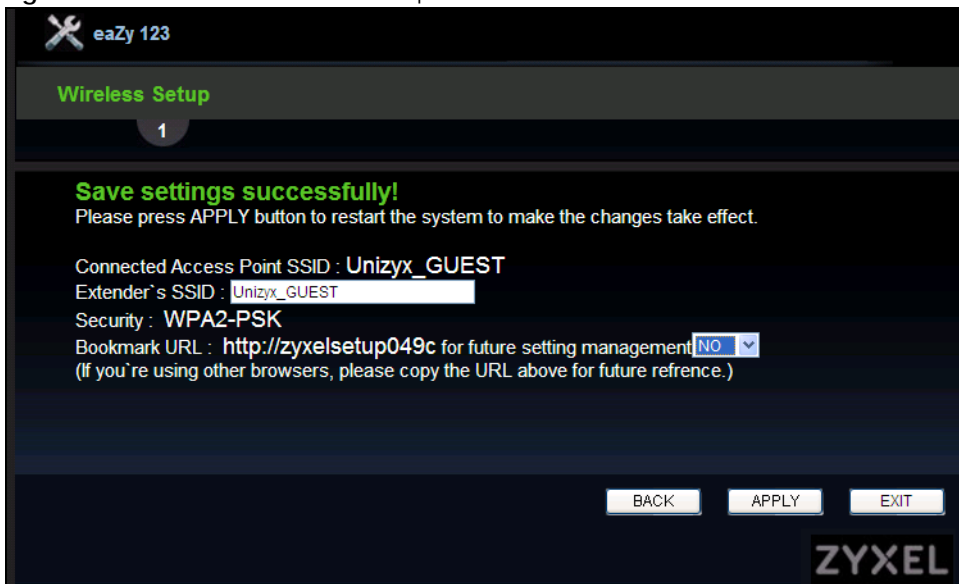
The following screen appears if the key fails to verify. Click **BACK** and check the key.

Figure 10 Wizard: Key Verification Failed



- 2 Click **Apply** to complete the wizard setup and restart the WRE2206.

Figure 11 Connection Wizard Complete



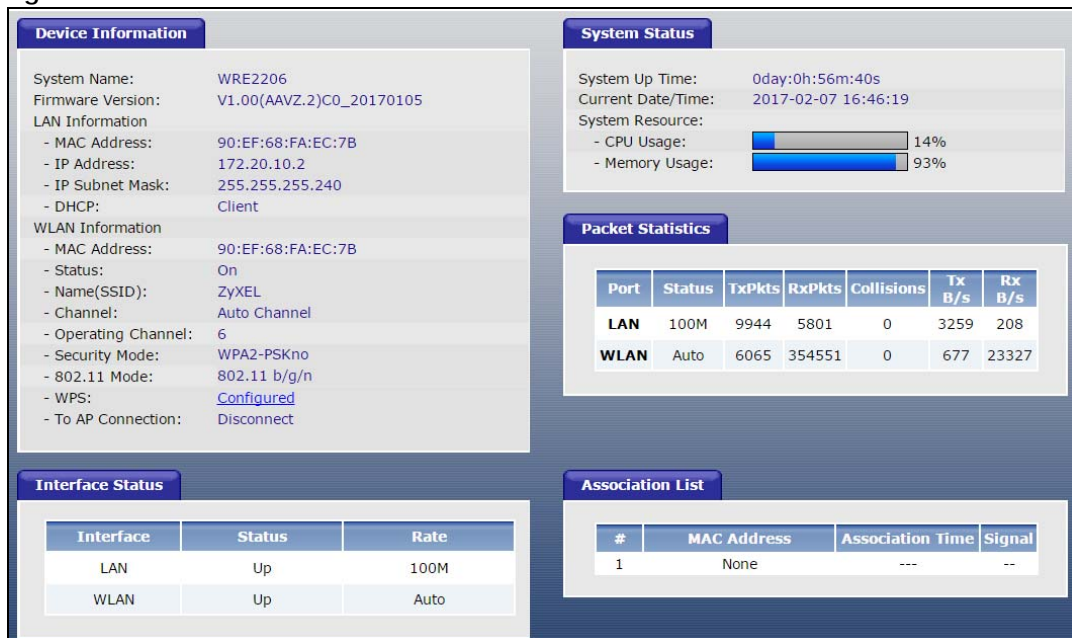
# CHAPTER 4

## Status

### 4.1 WRE2206 Status

The screen below shows the status screen.

Figure 12 Status Screen



The following table describes the icons shown in the **Status** screen.

Table 6 Status Screen Icon Key

ICON	DESCRIPTION
	Click this icon to open the setup wizard.
	Click this icon to view copyright and a link for related product information.
	Select a number of seconds or <b>None</b> from the drop-down list box to refresh all screen statistics automatically at the end of every time interval or to not refresh the screen statistics.
	Click this button to refresh the status screen statistics.

The following table describes the labels shown in the **Status** screen.

Table 7 Web Configurator Status Screen

LABEL	DESCRIPTION
Device Information	
System Name	This is the <b>System Name</b> .
Firmware Version	This is the current firmware version of the WRE2206.
LAN Information	
- MAC Address	This shows the LAN Ethernet adapter MAC Address of your device.
- IP Address	This shows the LAN port's IP address.
- IP Subnet Mask	This shows the LAN port's subnet mask.
- DHCP	This shows the LAN port's DHCP role.
WLAN Information	
- MAC Address	This shows the wireless adapter MAC Address of your device.
- Status	This shows the current status of the Wireless LAN - <b>On</b> or <b>Off</b> .
- Name (SSID)	This shows a descriptive name used to identify the WRE2206 in the wireless LAN.
- Channel	This shows the channel number which you select manually or the WRE2206 automatically scans and selects.
- Operating Channel	This shows the channel number which the WRE2206 is currently using over the wireless LAN.
- Security Mode	This shows the level of wireless security the WRE2206 is using.
- 802.11 Mode	This shows the wireless standard.
- WPS	This displays <b>Configured</b> when the WPS has been set up. This displays <b>Unconfigured</b> if the WPS has not been set up. Click the status to display <b>Network &gt; Wireless LAN &gt; WPS</b> screen.
- To AP Connection	This shows whether the WRE2206 is connected to an AP or not.
System Status	
System Up Time	This is the total time the WRE2206 has been on.
Current Date/Time	This field displays your WRE2206's present date and time.
System Resource	
- CPU Usage	This displays what percentage of the WRE2206's processing ability is currently used. When this percentage is close to 100%, the WRE2206 is running at full load, and the throughput is not going to improve anymore. If you want some applications to have more throughput, you should turn off other applications.
- Memory Usage	This shows what percentage of the heap memory the WRE2206 is using.
Interface Status	
Interface	This displays the WRE2206 port types. The port types are: <b>LAN</b> and <b>WLAN</b> .
Status	For the LAN port, this field displays <b>Down</b> (line is down) or <b>Up</b> (line is up or connected). For the WLAN, it displays <b>Up</b> when the WLAN is enabled or <b>Down</b> when the WLAN is disabled.
Rate	For the LAN ports, this displays the port speed and duplex setting or <b>NA</b> when the line is disconnected. For the WLAN, it displays the maximum transmission rate when the WLAN is enabled and <b>NA</b> when the WLAN is disabled or <b>Auto</b> .
Packet Statistics	

Table 7 Web Configurator Status Screen (continued)

LABEL	DESCRIPTION
Port	This is the WRE2206's port type.
Status	For the LAN ports, this displays the port speed and duplex setting or <b>Down</b> when the line is disconnected.  For the WLAN, it displays <b>Up</b> when the WLAN is enabled or <b>Down</b> when the WLAN is disabled or <b>Auto</b> .
TxPkts	This is the number of transmitted packets on this port.
RxPkts	This is the number of received packets on this port.
Collisions	This is the number of collisions on this port.
Tx B/s	This displays the transmission speed in bytes per second on this port.
Rx B/s	This displays the reception speed in bytes per second on this port.
Association List	
#	This is the index number of an associated wireless client.
MAC Address	This field displays the MAC address of an associated wireless client.
Association Time	This field displays the time a wireless station first associated with the WRE2206's WLAN network.
Signal	

## 4.2 Navigation Panel

Use the menu in the navigation panel menus to configure WRE2206 features.

Figure 13 Menu



The following table describes the sub-menus.

Table 8 Menu

LINK	TAB	FUNCTION
Status		This screen shows the WRE2206's general device, system and interface status information. Use this screen to access the wizard, and summary statistics tables.
Network		

Table 8 Menus (continued)

LINK	TAB	FUNCTION
Wireless LAN	AP Select	Use this screen to connect to an access point.
	General	Use this screen to configure wireless LAN.
	MAC Address List	Use the MAC Address List screen to allow devices to access the WRE2206.
	Advanced	This screen allows you to configure advanced wireless settings.
	QoS	Use this screen to configure Wi-Fi Multimedia Quality of Service (WMM QoS). WMM QoS allows you to prioritize wireless traffic according to the delivery requirements of individual services.
	WPS	Use this screen to configure WPS.
	WPS Station	Use this screen to connect the WRE2206 to a wireless station or access point using WPS.
LAN	IP	Use this screen to configure LAN IP address, subnet mask and gateway.
Maintenance		
System	Password	Use this screen to change the password.
Tools	Firmware	Use this screen to upload firmware to your WRE2206.
	Configuration	Use this screen to backup and restore the configuration or reset the factory defaults to your WRE2206.
	Restart	This screen allows you to reboot the WRE2206 without turning the power off.
	LED	Use this screen to configure which LEDs are enabled or disabled.

# CHAPTER 5

## Tutorials

### 5.1 Overview

This chapter provides tutorials for your WRE2206 as follows:

- Connecting a Wireless Client using WPS
  - [Push Button Configuration \(PBC\)](#)
  - [PIN Configuration](#)
- Connecting the WRE2206 to an AP
  - [Connecting to an AP with the WPS PBC Method](#)
  - [Connecting to an AP with the WPS PIN Method](#)
  - [Selecting an AP from an Automatically Detected List](#)
  - [Selecting an AP by Manually Entering Security Information](#)

### 5.2 Connecting a Wireless Client using WPS

This section gives you an example of how to connect a client to the WRE2206 using WPS.

There are two WPS methods for creating a secure connection. This tutorial shows you how to do both.

- **Push Button Configuration (PBC)** - create a secure wireless network by simply pressing the WPS button twice on the WRE2206's front panel or by clicking the **Start PBC** button in the **Network > Wireless LAN > WPS Station** screen. See [Section 5.2.1 on page 24](#). This is the easier method.
- **PIN Configuration** - create a secure wireless network simply by entering a wireless client's PIN (Personal Identification Number) in the WRE2206's interface. See [Section 5.2.2 on page 26](#). This is the more secure method, since one device can authenticate the other.

Note: The wireless client must be a WPS-aware device (for example, a WPS USB adapter or PCI card).

#### 5.2.1 Push Button Configuration (PBC)

This section gives you an example of how to set up a wireless network using WPS PBC. This example uses the WRE2206 as the registrar and NWD210N as the wireless client in a notebook.

- 1 Make sure that your WRE2206 is turned on and that it is within range of your computer.
- 2 Make sure that you have installed the wireless client (this example uses the NWD210N) driver and utility in your notebook.



- 3 In the wireless client utility, find the WPS settings. Enable WPS and press the WPS button (**Start** or **WPS** button)
- 4 Log into WRE2206's Web Configurator and navigate to the **Network > Wireless LAN > WPS Station** screen.
- 5 In the WRE2206's Web Configurator, select **Registrar** in **Config Mode** and then press **Start PBC**.

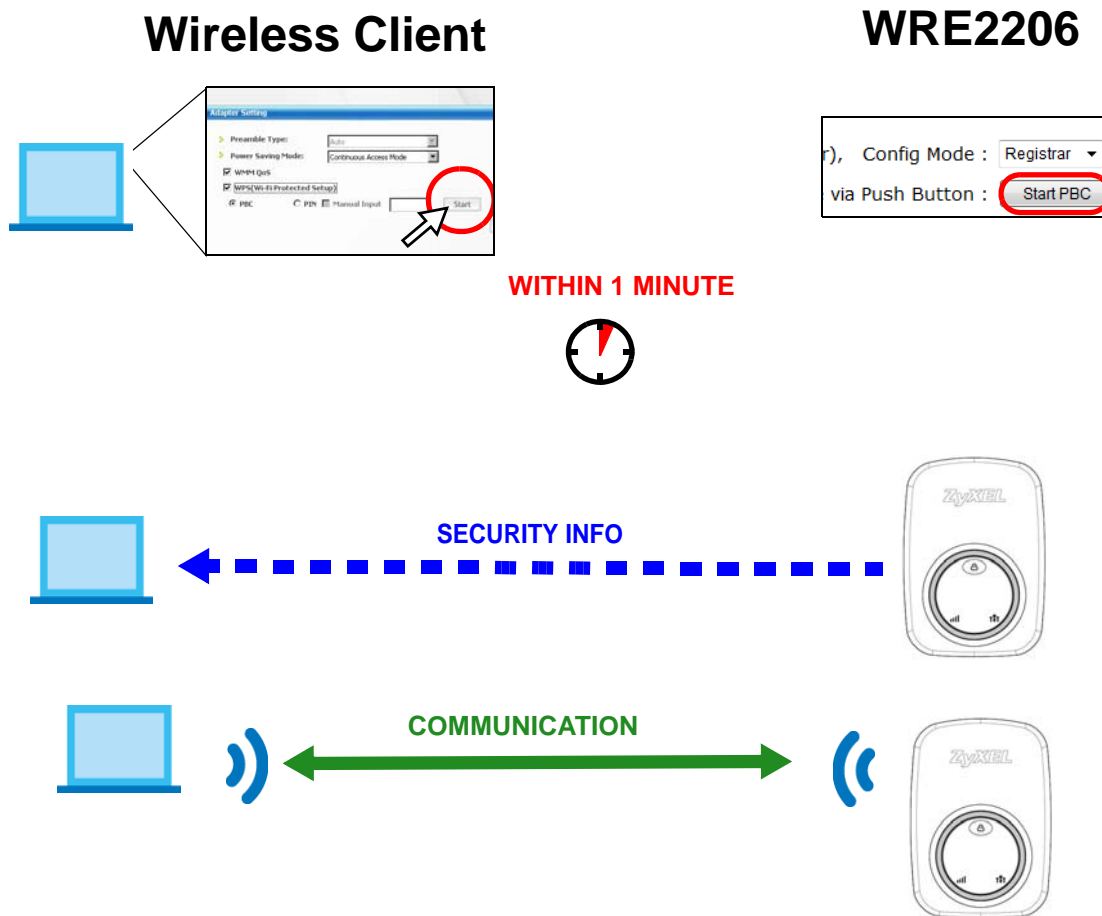
Note: Your WRE2206 has a WPS button, as well as a **Start PBC** button in the Web Configurator. Both buttons have exactly the same function; you can use one or the other.

Note: It doesn't matter whether you press the button on the WRE2206 or the wireless client first. WPS times out after two minutes of pressing a button. Press the button on the second device within about a minute of the first, then wait two minutes for the WPS configuration to complete.

The WRE2206 sends the proper configuration settings to the wireless client. Then the wireless client is able to communicate with the WRE2206 securely.

The following figure shows an example of how to set up wireless network and security by pressing a button on both WRE2206 and wireless client (the NWD210N in this example).

Figure 14 Example WPS Process: PBC Method



## 5.2.2 PIN Configuration

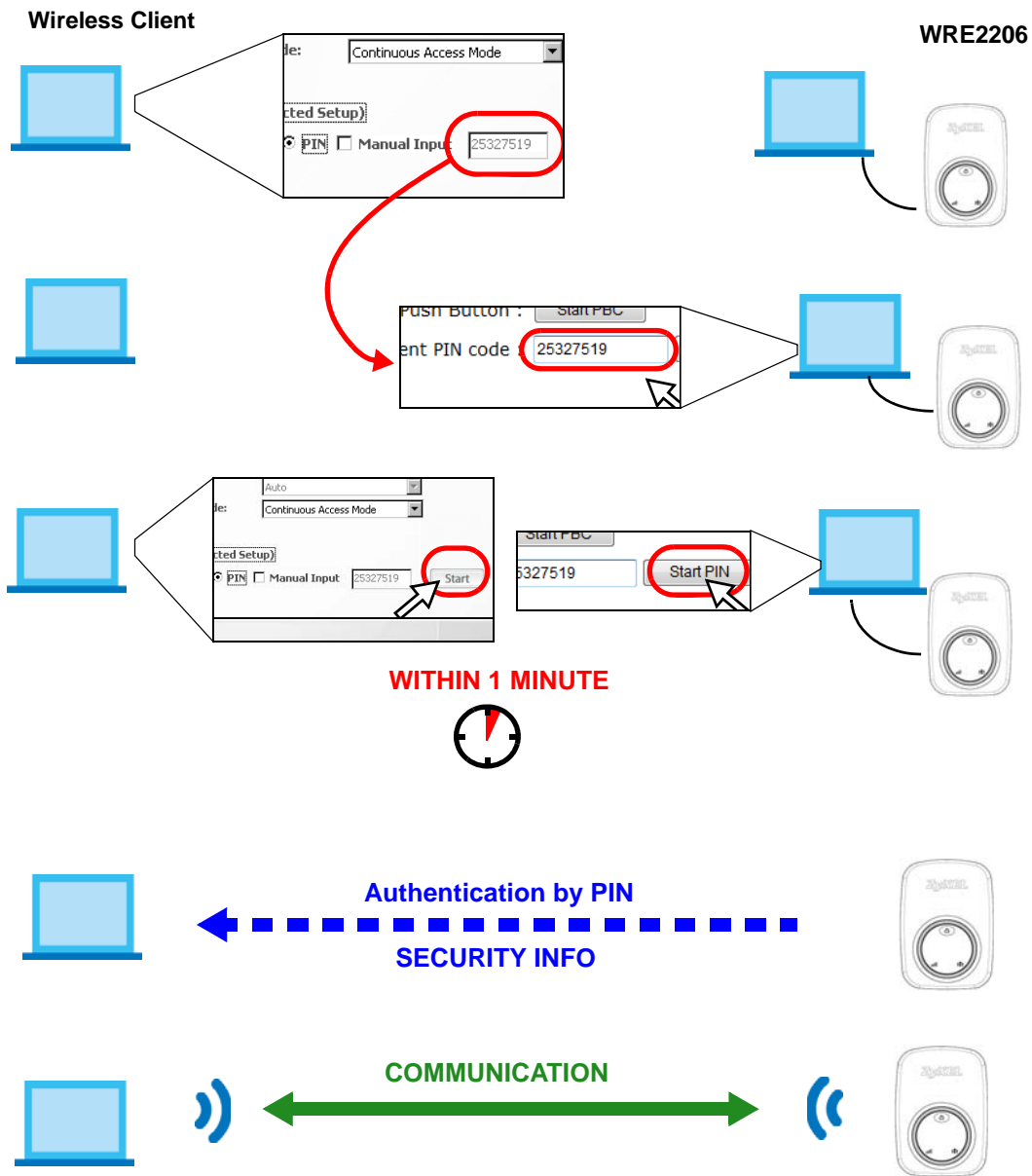
When you use the PIN configuration method, you need to use both WRE2206's configuration interface and the client's utilities.

- 1 Launch your wireless client's configuration utility. Go to the WPS settings and select the PIN method to get a PIN number.
- 2 On the WRE2206, navigate to the **Network > Wireless LAN > WPS Station** screen.
- 3 In the WRE2206's Web Configurator, select **Registrar** in **Config Mode**.
- 4 In the WRE2206's Web Configurator, enter the PIN number in the **Input client PIN code**.
- 5 Click the **Start** buttons (or the buttons next to the PIN fields) on both the wireless client utility screen and the WRE2206's **WPS Station** screen within about one minute, then wait two minutes for the WPS configuration to complete.

The WRE2206 authenticates the wireless client and sends the proper configuration settings to the wireless client. Then the wireless client is able to communicate with the WRE2206 securely.

The following figure shows an example of how to set up wireless network and security on WRE2206 and wireless client (ex. NWD210N in this example) by using PIN method.

Figure 15 Example WPS Process: PIN Method



### 5.3 Connecting the WRE2206 to an AP

This section gives you an example of how to connect the WRE2206 to an AP.

There are four AP connection methods. This tutorial shows you how to use all of them.

- **Connecting to an AP with the WPS PBC method** - create a secure wireless network simply by pressing a button. See [Section 5.3.1 on page 28](#). This is the easier method.

- **Connecting to an AP with the WPS PIN method** - create a secure wireless network simply by entering the WRE2206's PIN (Personal Identification Number) in the AP's interface. See [Section 5.3.2 on page 29](#). This is the more secure method, since one device can authenticate the other.
- **Selecting an AP from an Automatically Detected List** - create a secure wireless network simply by selecting an AP from a list of detected APs. See [Section 5.3.3 on page 30](#). This is the easier method.
- **Selecting an AP by Manually Entering Security Information** - create a secure wireless network by manually entering the AP's wireless security settings in the WRE2206's interface. See [Section 5.3.4 on page 32](#). This is useful when the AP is hidden.

### 5.3.1 Connecting to an AP with the WPS PBC Method

This section gives you an example of how to connect to an AP using WPS PBC. This example uses the WRE2206 as the enrollee and an AP as the registrar.

- 1 Make sure that your WRE2206 is turned on and that it is within range of the AP.
- 2 Make sure that you have installed the AP and have access to the configuration interface of the AP or the AP's WPS button.
- 3 Log into WRE2206's Web Configurator and navigate to the **Network > Wireless LAN > WPS Station** screen. Select **Enrollee** in **Config Mode** and press **Start PBC**.
- 4 In the configuration interface of the AP, find the WPS settings. Enable WPS and press the WPS button (**Start** or **WPS** button)

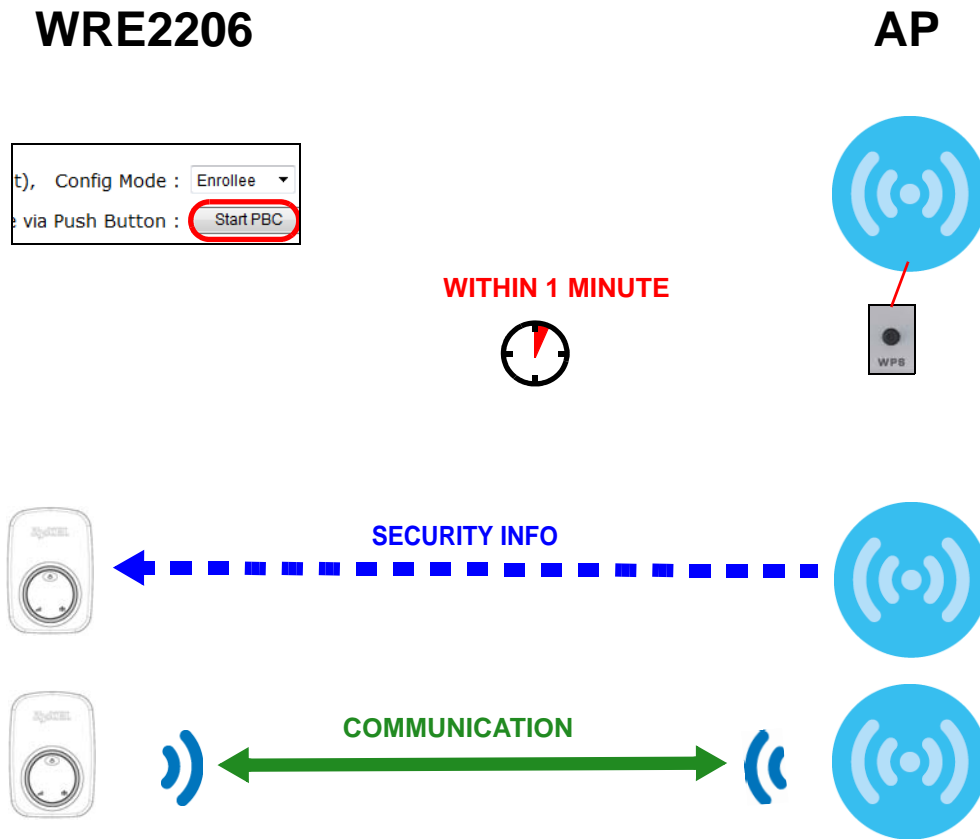
Note: Your WRE2206 has a WPS button located on its panel, as well as a WPS button in its configuration utility. Both buttons have exactly the same function; you can use one or the other.

Note: It doesn't matter whether you press the button on the WRE2206 or the AP first. WPS times out after two minutes of pressing a button. Press the button on the second device within about a minute of the first, then wait two minutes for the WPS configuration to complete.

The AP sends the proper configuration settings to the WRE2206. Then the WRE2206 is able to communicate with the AP securely.

The following figure shows an example of how to set up wireless network and security by pressing a button on both WRE2206 and AP.

Figure 16 Example Connection to AP using WPS: PBC Method



### 5.3.2 Connecting to an AP with the WPS PIN Method

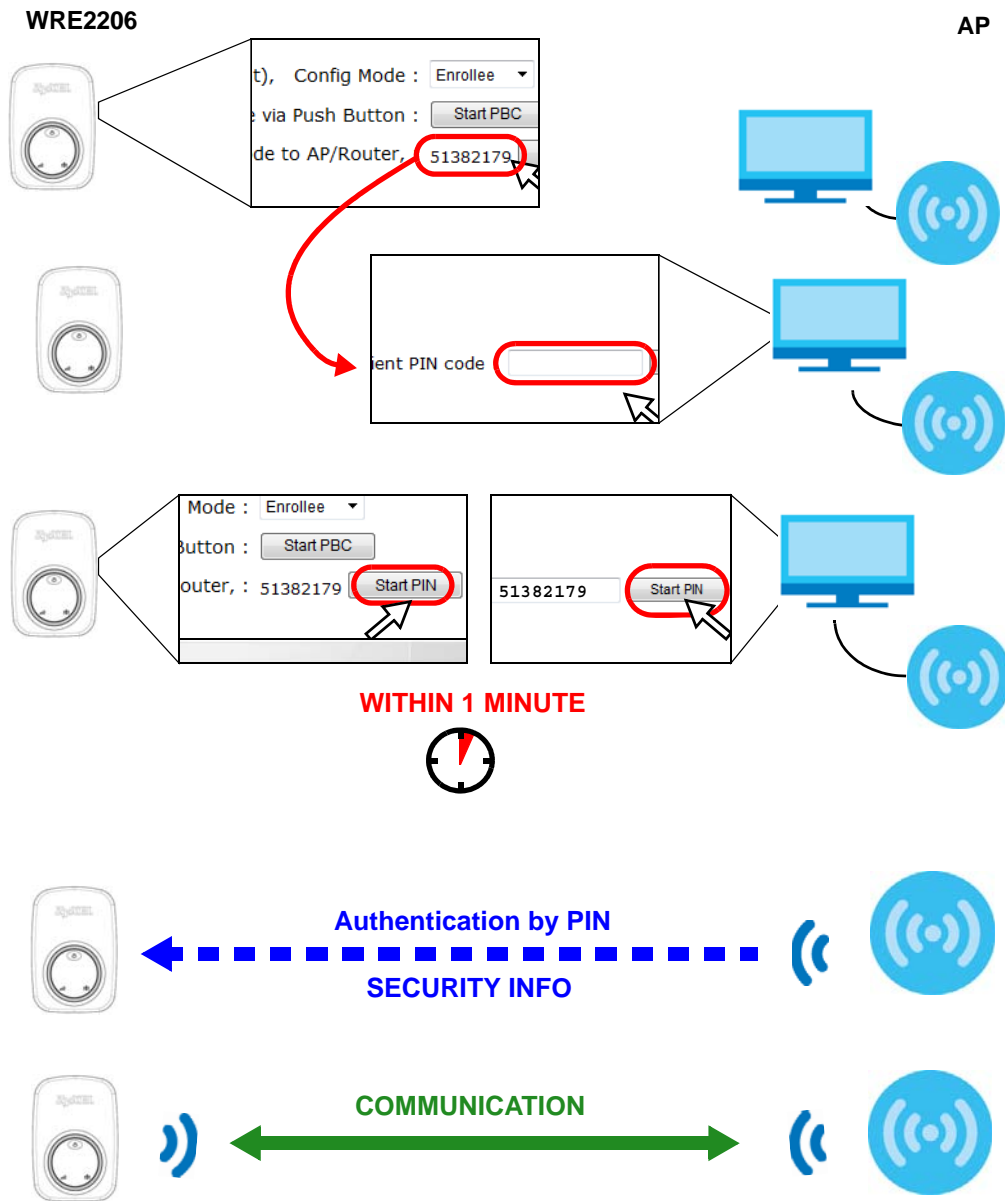
When you use the PIN configuration method, you need to use both the configuration interface of the AP and the WRE2206's configuration interface.

- 1 Log into WRE2206's Web Configurator and navigate to the **Network > Wireless LAN > WPS Station** screen. Select **Enrollee** in **Config Mode** to get a PIN number.
- 2 Enter the PIN number in the WPS PIN field of the AP's configuration interface.
- 3 Click the **Start PIN** button on the WRE2206 and the Start button (or the button next to the PIN field) on the AP's configuration interface within about one minute, then wait two minutes for the WPS configuration to complete.

The AP authenticates the WRE2206 and sends the proper configuration settings to the WRE2206. This may take up to two minutes. Then the WRE2206 is able to communicate with the AP securely.

The following figure shows an example of how to set up wireless network and security on the AP and WRE2206 by using PIN method.

Figure 17 Example Connection to AP using WPS: PIN Method



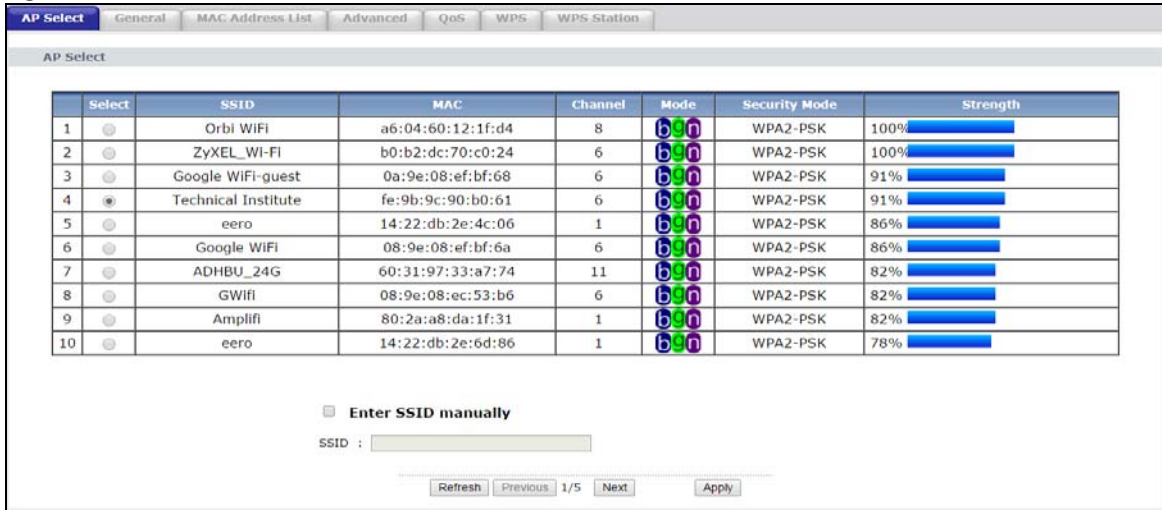
### 5.3.3 Selecting an AP from an Automatically Detected List

Follow the steps below to create a secure wireless network by selecting an AP from a list of detected APs.

The instructions require that your hardware is connected (see the Quick Start Guide) and you are logged into the Web Configurator through your LAN connection (see [Section 2.2 on page 12](#)).

- 1 Select an AP from the **Select** column and click **Next**.

**Figure 18** Tutorial: Selecting an automatically detected AP



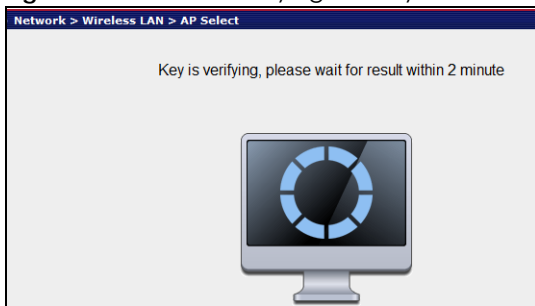
- 2 Type a key into the **KEY** field and click **Next**.

**Figure 19** Tutorial: The KEY field



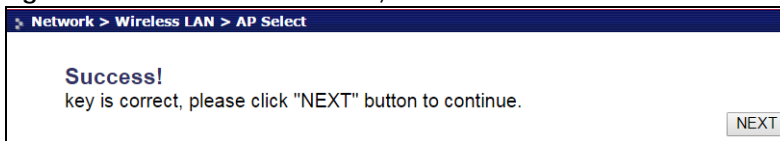
- 3 Wait for the WRE2206 to verify the key with the AP.

**Figure 20** Tutorial: Verifying the key



- 4 When the key is verified, click **Next**.

**Figure 21** Tutorial: Successful key verification



- 5 Click **APPLY** to save settings and restart the WRE2206. Click **CONTINUE** to go to the Status screen without saving the settings and restarting the WRE2206.

Figure 22 Tutorial: Saving settings

Network > Wireless LAN > AP Select

**Save settings successfully!**

You may press CONTINUE button to continue configuring other settings or press APPLY button to restart the system to make the changes take effect.

Connected Access Point SSID : **Technical Institute**

Extender's SSID :

Security : **WPA2-PSK**

Bookmark URL : <http://zyxelsetup> for future setting management  (If you're using other browsers, please copy the URL above for future reference.)

### 5.3.4 Selecting an AP by Manually Entering Security Information

This example shows you how to configure wireless security settings with the following parameters on your WRE2206.

SSID	ExampleSSID
Channel	7
Security	WPA2 PSK

Follow the steps below to create a secure wireless network by manually entering the AP's wireless security settings in the WRE2206's interface.

The instructions require that your hardware is connected (see the Quick Start Guide) and you are logged into the Web Configurator through your LAN connection (see [Section 2.2 on page 12](#)).

- 1 Select **Setup repeater manually**.
- 2 Type the SSID of the AP into the **SSID** field and click **Next**.

Figure 23 Tutorial: Typing an SSID

AP Select

General | MAC Address List | Advanced | QoS | WPS | WPS Station

AP Select

Select	SSID	MAC	Channel	Mode	Security Mode	Strength
<input type="radio"/>	Orbi WIFI	a6:04:60:12:1f:d4	8		WPA2-PSK	100%
<input type="radio"/>	ZyXEL_Wi-Fi	b0:b2:dc:70:c0:24	6		WPA2-PSK	100%
<input type="radio"/>	Google WiFi-guest	0a:9e:08:ef:bf:68	6		WPA2-PSK	91%
<input type="radio"/>	Technical Institute	fe:9b:9c:90:b0:61	6		WPA2-PSK	91%
<input type="radio"/>	eero	14:22:db:2e:4c:06	1		WPA2-PSK	86%
<input type="radio"/>	Google WiFi	08:9e:08:ef:bf:6a	6		WPA2-PSK	86%
<input type="radio"/>	ADHBU_24G	60:31:97:33:a7:74	11		WPA2-PSK	82%
<input type="radio"/>	GWifi	08:9e:08:ec:53:b6	6		WPA2-PSK	82%
<input type="radio"/>	Amplifi	80:2a:a8:da:1f:31	1		WPA2-PSK	82%
<input type="radio"/>	eero	14:22:db:2e:6d:86	1		WPA2-PSK	78%

Enter SSID manually

SSID :

1/5

- 3 Select the security settings and click **Next**.



Figure 24 Tutorial: Security Settings

The screenshot shows the 'Security' configuration page for the WRE2206. The 'AP Select' tab is active. The 'Security' section is expanded, showing the following settings:

- Select SSID:** SSID choice : EampleSSID
- Security Settings:**
  - Encryption : WPA pre-shared key ▼
  - WPA Unicast Cipher Suite :  WPA(TKIP)  WPA2(AES)  WPA/WPA2 Mixed
  - Pre-shared Key Format : Passphrase ▼
  - Pre-shared Key : [Empty text box]
  - Channel : 7 ▼

Buttons for 'APPLY' and 'CANCEL' are located at the bottom right of the form.

- Click **Apply** to save settings and restart the WRE2206. Click **CONTINUE** to go to the Status screen without saving the settings and restarting the WRE2206.

Figure 25 Tutorial: Saving settings

The screenshot shows the 'Save settings successfully!' confirmation screen. The page title is 'Network > Wireless LAN > AP Select'. The message reads: 'Save settings successfully! You may press CONTINUE button to continue configuring other settings or press APPLY button to restart the system to make the changes take effect.'

The current configuration is displayed as follows:

- Connected Access Point SSID : **Technical Institute**
- Extender's SSID : Technical Institute
- Security : **WPA2-PSK**

A bookmark URL is provided: 'Bookmark URL : <http://zyxelsetup> for future setting management Save ▼ (If you're using other browsers, please copy the URL above for future reference.)'

Buttons for 'Back', 'CONTINUE', and 'APPLY' are located at the bottom of the screen.

---

# PART II

## Technical Reference

---

# CHAPTER 6

## Wireless LAN

### 6.1 Overview

This chapter discusses how to configure the wireless network settings in your WRE2206. See [Section 1.1 on page 8](#) for an overview of wireless networks.

### 6.2 What You Can Do

- Use the **General** screen to enable the Wireless LAN, enter the SSID and select the wireless security mode ([Section 6.4 on page 37](#)).
- Use the **MAC Address List** screen to allow or deny wireless stations based on their MAC addresses from connecting to the WRE2206 ([Section 6.5 on page 38](#)).
- Use the **Advanced** screen to allow intra-BSS networking and set the RTS/CTS Threshold ([Section 6.6 on page 39](#)).
- Use the **QoS** screen to enable Wifi MultiMedia Quality of Service (WMM QoS). WMM QoS prioritizes traffic using pre-defined voice, video, best-effort and background priorities ([Section 6.7 on page 40](#)).
- Use the **WPS** screen to quickly set up a wireless network with strong security, without having to configure security settings manually ([Section 6.8 on page 40](#)).
- Use the **WPS Station** screen to add a wireless station using WPS ([Section 6.9 on page 41](#)).
- Use the **AP Select** screen to choose an access point that you want the WRE2206 to connect to. You should know the security settings of the target AP ([Section 6.10 on page 42](#)).

### 6.3 What You Should Know

Every wireless network must follow these basic guidelines.

- Every wireless client in the same wireless network must use the same SSID.  
The SSID is the name of the wireless network. It stands for Service Set IDentity.
- If two wireless networks overlap, they should use different channels.  
Like radio stations or television channels, each wireless network uses a specific channel, or frequency, to send and receive information.
- Every wireless client in the same wireless network must use security compatible with the AP.  
Security stops unauthorized devices from using the wireless network. It can also protect the information that is sent in the wireless network.

## 6.3.1 Wireless Security Overview

The following sections introduce different types of wireless security you can set up in the wireless network.

### 6.3.1.1 MAC Address List

Every wireless client has a unique identification number, called a MAC address.<sup>1</sup> A MAC address is usually written using twelve hexadecimal characters<sup>2</sup>; for example, 00A0C5000002 or 00:A0:C5:00:00:02. To get the MAC address for each wireless client, see the appropriate User's Guide or other documentation.

You can use the MAC Address List to tell the AP which wireless clients are allowed to use the wireless network. If a wireless client is allowed to use the wireless network, it still has to have the correct settings (SSID, channel, and security). If a wireless client is not allowed to use the wireless network, it does not matter if it has the correct settings.

This type of security does not protect the information that is sent in the wireless network. Furthermore, there are ways for unauthorized devices to get the MAC address of an authorized wireless client. Then, they can use that MAC address to use the wireless network.

### 6.3.1.2 Encryption

Wireless networks can use encryption to protect the information that is sent in the wireless network. Encryption is like a secret code. If you do not know the secret code, you cannot understand the message.

Table 9 Types of Encryption for Each Type of Authentication

	<b>NO AUTHENTICATION</b>
Weakest	No Security
↕	Static WEP
↕	WPA-PSK
Strongest	WPA2-PSK

For example, if users do not log in to the wireless network, you can choose no authentication, if users do log on to the wireless network, you can choose No Security, **Static WEP**, **WPA-PSK**, or **WPA2-PSK**.

Usually, you should set up the strongest encryption that every wireless client in the wireless network supports. Suppose the wireless network has two wireless clients. Device A only supports WEP, and device B supports WEP and WPA-PSK. Therefore, you should set up **Static WEP** in the wireless network.

Note: It is recommended that wireless networks use WPA-PSK, or stronger encryption. IEEE 802.1x and WEP encryption are better than none at all, but it is still possible for unauthorized devices to figure out the original information pretty quickly.

Many types of encryption use a key to protect the information in the wireless network. The longer the key, the stronger the encryption. Every wireless client in the wireless network must have the same key.

- 
1. Some wireless devices, such as scanners, can detect wireless networks but cannot use wireless networks. These kinds of wireless devices might not have MAC addresses.
  2. Hexadecimal characters are 0, 1, 2, 3, 4, 5, 6, 7, 8, 9, A, B, C, D, E, and F.

### 6.3.1.3 WPS

WiFi Protected Setup (WPS) is an industry standard specification, defined by the WiFi Alliance. WPS allows you to quickly set up a wireless network with strong security, without having to configure security settings manually. Depending on the devices in your network, you can either press a button (on the device itself, or in its configuration utility) or enter a PIN (Personal Identification Number) in the devices. Then, they connect and set up a secure network by themselves. See how to set up a secure wireless network using WPS in the [Section 5.2 on page 24](#).

## 6.4 General Wireless LAN Screen

Use this screen to enable the Wireless LAN, enter the SSID and select the wireless security mode.

Note: If you are configuring the WRE2206 from a computer connected to the wireless LAN and you change the WRE2206's SSID, channel or security settings, you will lose your wireless connection when you press **Apply** to confirm. You must then change the wireless settings of your computer to match the WRE2206's new settings.

Click **Network > Wireless LAN** to open the **General** screen.

**Figure 26** Network > Wireless LAN > General

The following table describes the general wireless LAN labels in this screen.

**Table 10** Network > Wireless LAN > General

LABEL	DESCRIPTION
WLAN STA Information	This shows the wireless and security settings of the selected AP wireless network.
SSID	This displays the Service Set IDentity of the wireless device to which you are connecting.
WLAN AP Information	Use this section to configure the wireless settings between the WRE2206 and its wireless clients.
Name(SSID)	(Service Set IDentity) The SSID identifies the Service Set with which a wireless station is associated. Wireless stations associating to the access point (AP) must have the same SSID. Enter a descriptive name (up to 32 printable 7-bit ASCII characters) for the wireless LAN.
Hide SSID	Select this check box to hide the SSID in the outgoing beacon frame so a station cannot obtain the SSID through scanning using a site survey tool.
Operating Channel	This displays the channel the WRE2206 is currently using.

Table 10 Network &gt; Wireless LAN &gt; General (continued)

LABEL	DESCRIPTION
Apply	Click <b>Apply</b> to save your changes back to the WRE2206.
Reset	Click <b>Reset</b> to reload the previous configuration for this screen.

## 6.5 MAC Address List

The MAC Address List screen allows you to specify which devices are allowed to access the WRE2206, while denying access to all unspecified devices. Every Ethernet device has a unique MAC (Media Access Control) address. The MAC address is assigned at the factory and consists of six pairs of hexadecimal characters, for example, 00:A0:C5:00:00:02. You need to know the MAC address of the devices to configure this screen.

To change your WRE2206's MAC Address List settings, click **Network > Wireless LAN > MAC Address List**. The screen appears as shown.

Figure 27 Network &gt; Wireless LAN &gt; MAC Address List

Network > Wireless LAN > MAC Address List

AP Select General **MAC Address List** Advanced QoS WPS WPS Station

MAC Address List

For security reason, the Wireless Repeater features MAC Address Filtering that only allows authorized MAC Addresses associating to the Wireless Repeater.

Active

Set	MAC Address
1	00:00:00:00:00:00
2	00:00:00:00:00:00
3	00:00:00:00:00:00
4	00:00:00:00:00:00
5	00:00:00:00:00:00
6	00:00:00:00:00:00
7	00:00:00:00:00:00
8	00:00:00:00:00:00
9	00:00:00:00:00:00
10	00:00:00:00:00:00
11	00:00:00:00:00:00
12	00:00:00:00:00:00
13	00:00:00:00:00:00
14	00:00:00:00:00:00
15	00:00:00:00:00:00
16	00:00:00:00:00:00

Apply Reset

The following table describes the labels in this menu.

Table 11 Network &gt; Wireless LAN &gt; MAC Address List

LABEL	DESCRIPTION
Active	Select this to enable MAC address filtering.
Set	This is the index number of the MAC address.

Table 11 Network &gt; Wireless LAN &gt; MAC Address List (continued)

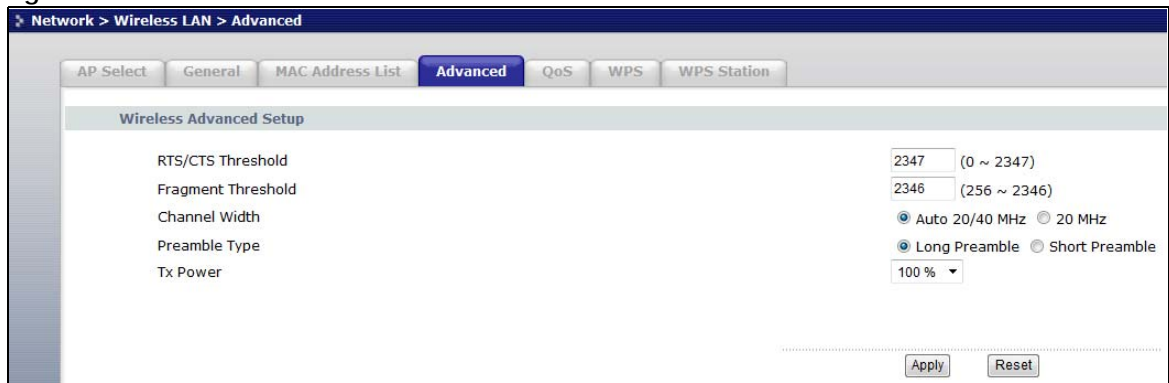
LABEL	DESCRIPTION
MAC Address	Enter the MAC addresses of the wireless station that are allowed access to the WRE2206 in these address fields. Enter the MAC addresses in a valid MAC address format, that is, six hexadecimal character pairs, for example, 12:34:56:78:9a:bc.
Apply	Click <b>Apply</b> to save your changes back to the WRE2206.
Reset	Click <b>Reset</b> to reload the previous configuration for this screen.

## 6.6 Wireless LAN Advanced Screen

Use this screen to configure advanced wireless LAN parameters.

Click **Network > Wireless LAN > Advanced**. The screen appears as shown.

Figure 28 Network &gt; Wireless LAN &gt; Advanced



The following table describes the labels in this screen.

Table 12 Network &gt; Wireless LAN &gt; Advanced

LABEL	DESCRIPTION
Wireless Advanced Setup	
RTS/CTS Threshold	Data with its frame size larger than this value will perform the RTS (Request To Send)/CTS (Clear To Send) handshake. Enter a value between <b>0</b> and <b>2347</b> .
Fragment Threshold	The threshold (number of bytes) for the fragmentation boundary for directed messages. It is the maximum data fragment size that can be sent. Enter an even number between <b>256</b> and <b>2346</b> .
Channel Width	Select whether the WRE2206 uses a wireless channel width of 20MHz or Auto 20/40MHz. A standard 20MHz channel offers transfer speeds of up to 150Mbps whereas a 40MHz channel uses two standard channels and offers speeds of up to 300 Mbps. Because not all devices support 40MHz channels, select Auto 20/40MHz to allow the WRE2206 to adjust the channel bandwidth automatically.
Preamble Type	A preamble affects the timing in your wireless network. There are two preamble modes: long and short. If a device uses a different preamble mode than the WRE2206 does, it cannot communicate with the WRE2206.
Tx Power	This field controls the transmission power of the WRE2206. When using the WRE2206 with a notebook computer, select a lower transmission power level when you are close to the AP in order to conserve battery power.

Table 12 Network &gt; Wireless LAN &gt; Advanced (continued)

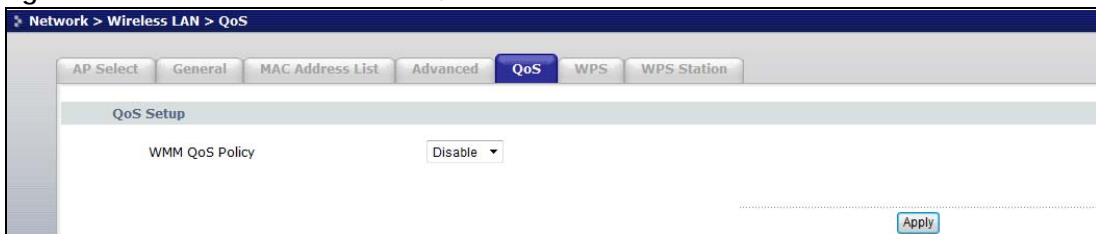
LABEL	DESCRIPTION
Apply	Click <b>Apply</b> to save your changes to the WRE2206.
Reset	Click <b>Reset</b> to reload the previous configuration for this screen.

## 6.7 Quality of Service (QoS) Screen

Use the **QoS** screen to enable Wifi MultiMedia Quality of Service (WMM QoS). WMM QoS prioritizes traffic using pre-defined voice, video, best-effort and background priorities.

Click **Network > Wireless LAN > QoS**. The following screen appears.

Figure 29 Network &gt; Wireless LAN &gt; QoS



The following table describes the labels in this screen.

Table 13 Network &gt; Wireless LAN &gt; QoS

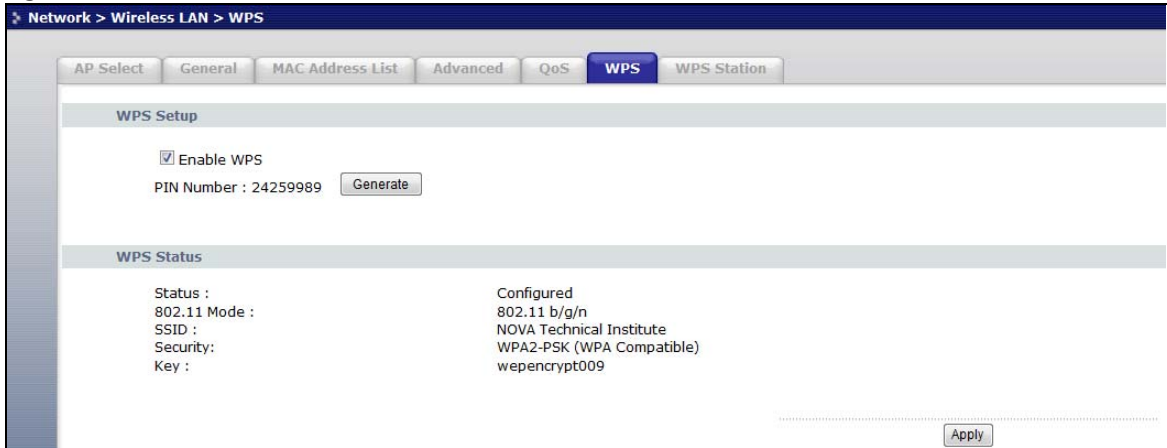
LABEL	DESCRIPTION
WMM QoS Policy	Enable this to have the WRE2206 automatically give a service a priority level according to the ToS value in the IP header of packets it sends. WMM QoS (Wifi MultiMedia Quality of Service) gives high priority to voice and video, which makes them run more smoothly.
Apply	Click <b>Apply</b> to save your changes to the WRE2206.

## 6.8 WPS Screen

Use this screen to enable/disable WPS, view or generate a new PIN and check current WPS status. To open this screen, click **Network > Wireless LAN > WPS** tab.



Figure 30 Network &gt; Wireless LAN &gt; WPS



The following table describes the labels in this screen.

Table 14 Network &gt; Wireless LAN &gt; WPS

LABEL	DESCRIPTION
WPS Setup	
Enable WPS	Select this to enable the WPS feature.
PIN Number	This displays a PIN number last time system generated. Click <b>Generate</b> to generate a new PIN number.
WPS Status	
Status	This displays <b>Configured</b> when the WRE2206 has connected to a wireless network using WPS or when <b>Enable WPS</b> is selected and wireless or wireless security settings have been changed. The current wireless and wireless security settings also appear in the screen.  This displays <b>Unconfigured</b> if WPS is disabled and there are no wireless or wireless security changes on the WRE2206 or you click <b>Release_Configuration</b> to remove the configured wireless and wireless security settings.
802.11 Mode	This is the 802.11 mode used. Only compliant WLAN devices can associate with the WRE2206.
SSID	This is the name of the wireless network.
Security	This is the type of wireless security employed by the network.
Key	This is the key of the wireless network.
Apply	Click <b>Apply</b> to save your changes back to the WRE2206.
Refresh	Click <b>Refresh</b> to get this screen information afresh.

## 6.9 WPS Station Screen

Use this screen when you want to add a wireless station using WPS.

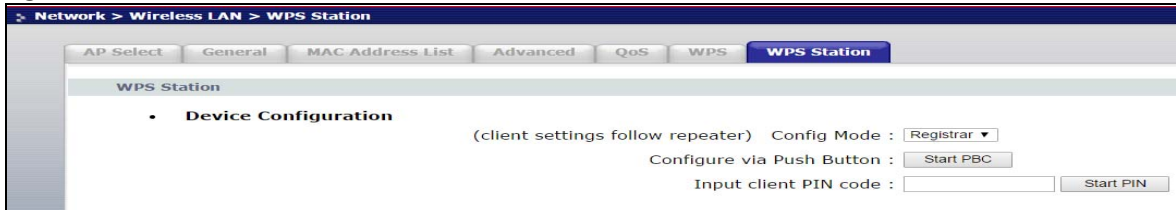
Note: WPS can only be configured between two devices at a time. For example if devices A and B are first configured using WPS, then use either A or B to configure device C using WPS.

To open this screen, click **Network > Wireless LAN > WPS Station** tab.

Note: WPS times out after two minutes of pressing a button. Press the button on the second device within about a minute of the first, then wait two minutes for the WPS configuration to complete.

To add the second wireless station, you have to press these buttons on both device and the wireless station again after the first 2 minutes.

**Figure 31** Network > Wireless LAN > WPS Station



The following table describes the labels in this screen.

**Table 15** Network > Wireless LAN > WPS Station

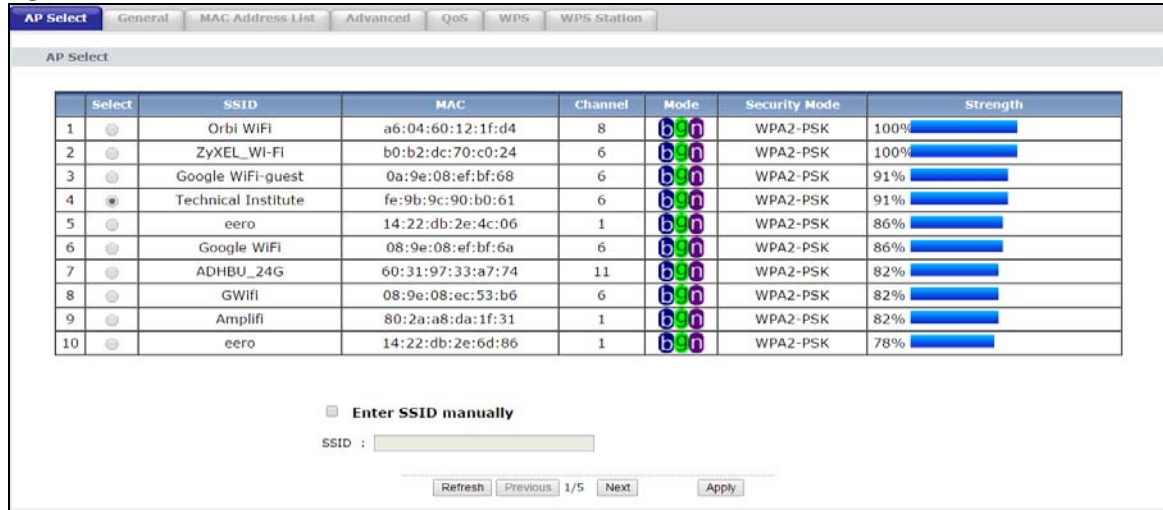
LABEL	DESCRIPTION
Config Mode	Use this to select <b>Registrar</b> or <b>Enrollee</b> mode. Select <b>Registrar</b> mode to make wireless clients follow the wireless settings of the WRE2206. Select <b>Enrollee</b> mode to make the WRE2206 follow the wireless settings of an access point.
Configure via Push Button	Use this button when you use the PBC (Push Button Configuration) method to configure wireless stations's wireless settings. See <a href="#">Section 5.2.1 on page 24</a> .  Click this to start WPS-aware wireless station scanning and the wireless security information synchronization.
Input client PIN code	Use this button when you use the PIN Configuration method to configure wireless station's wireless settings. See <a href="#">Section 5.2.2 on page 26</a> .  Type the same PIN number generated in the wireless station's utility. Then click <b>Start</b> to associate to each other and perform the wireless security information synchronization.

## 6.10 AP Select Screen

Use this screen to choose an access point that you want the WRE2206 to connect to. You should know the security settings of the target AP.

To open this screen, click **Network > Wireless LAN > AP Select** tab.

Figure 32 Network &gt; Wireless LAN &gt; AP Select



The following table describes the labels in this screen.

Table 16 Network &gt; Wireless LAN &gt; AP Select

LABEL	DESCRIPTION
Select	Use the radio button to select the wireless device to which you want to connect.
SSID	This displays the Service Set IDentity of the wireless device. The SSID is a unique name that identifies a wireless network. All devices in a wireless network must use the same SSID.
MAC	This displays the MAC address of the wireless device.
Channel	This displays the channel number used by this wireless device.
Mode	This displays which IEEE 802.11b/g/n wireless networking standards the wireless device supports.
Security Mode	This displays the type of security configured on the wireless device. When <b>no</b> is shown, no security is configured and you can connect to it without a password.
Strength	This displays the strength of the wireless signal. The signal strength mainly depends on the antenna output power and the distance between your WRE2206 and this device.
Enter SSID manually	Select this to setup the AP manually.
SSID	If <b>Enter SSID manually</b> is selected, use this field to type the SSID of the AP. This is useful when the AP's SSID is hidden.
Refresh	Click this to search for available wireless devices within transmission range and update this table.
Previous	Click this to see the previous page of APs.
Next	Click this to see the next page of APs.
Apply	Click this to start the next step in the AP setup process.

# CHAPTER 7

# LAN

## 7.1 Overview

This screen allows you to assign the WRE2206 a fixed or dynamic IP address. The default IP address is 192.168.1.2. In initial configuration, the WRE2206 acts as a DHCP server, so it can assign your computer an IP address in the same network range as the default IP. After the WRE2206 connects to an AP, the DHCP server function is disabled and your computer gets its IP from the AP. If the AP connection is dropped, connect to the WRE2206 again using the default domain name, "http://zyxelsetup" (for Windows) or "http://zyxelsetup.local" (for Mac).

## 7.2 What You Need To Know

The LAN parameters of the WRE2206 are preset in the factory with the following values:

- IP address of 192.168.1.2 with subnet mask of 255.255.255.0 (24 bits)

## 7.3 LAN IP Screen

Use this screen to change your basic LAN settings. Click **Network > LAN**.

Figure 33 Network > LAN > IP

The screenshot shows the 'Network > LAN > IP' configuration page. At the top, there's a breadcrumb trail 'Network > LAN > IP'. Below that, there's a tab labeled 'IP'. The main content area is titled 'LAN TCP/IP'. It features two radio buttons: 'Get from DHCP Server' (which is selected) and 'User Defined LAN IP'. Under the 'User Defined LAN IP' option, there are three input fields: 'IP Address' with the value '192.168.2.254', 'IP Subnet Mask' with the value '255.255.255.0', and 'Gateway' which is empty. At the bottom right, there are 'Apply' and 'Reset' buttons.

The following table describes the labels in this screen.

Table 17 Network > LAN > IP

LABEL	DESCRIPTION
Get from DHCP Server	Select this to have the WRE2206 get a dynamic IP address from a DHCP server.
User Defined LAN IP	Click this to enable the manual IP configuration.

Table 17 Network > LAN > IP (continued)

LABEL	DESCRIPTION
IP Address	Type the IP address of your WRE2206 in dotted decimal notation 192.168.1.2 (factory default).
IP Subnet Mask	The subnet mask specifies the network number portion of an IP address.
Gateway	Enter the gateway of your WRE2206 in dotted decimal notation.
Apply	Click <b>Apply</b> to save your changes back to the WRE2206.
Reset	Click <b>Reset</b> to begin configuring this screen afresh.

# CHAPTER 8

## System

### 8.1 Overview

This chapter provides information on the **System** screen.

### 8.2 What You Can Do

Use the **Password** screen to set the password ([Section 8.3 on page 46](#)).

### 8.3 System Password Screen

Use this screen to set the web configurator password. Click **Maintenance > System**. The following screen displays.

**Figure 34** Maintenance > System > Password



The following table describes the labels in this screen.

Table 18 Maintenance > System > Password

LABEL	DESCRIPTION
Password Setup	Change your WRE2206's password (recommended) using the fields as shown.
Old Password	Type the default password or the existing password you use to access the system in this field.
New Password	Type your new system password (up to 30 characters). Note that as you type a password, the screen displays an asterisk (*) for each character you type.
Retype to Confirm	Type the new password again in this field.
Apply	Click <b>Apply</b> to save your changes back to the WRE2206.
Reset	Click <b>Reset</b> to begin configuring this screen afresh.

# CHAPTER 9

# Tools

## 9.1 Overview

This chapter shows you how to upload a new firmware, upload or save backup configuration files, restart the WRE2206 and configure LEDs.

## 9.2 What You Can Do

- Use the **Firmware** screen to upload firmware to your WRE2206 ([Section 9.3 on page 47](#)).
- Use the **Configuration** screen to view information related to factory defaults, backup configuration, and restore configuration ([Section 9.4 on page 49](#)).
- Use the **Restart** screen to have the WRE2206 reboot ([Section 9.5 on page 51](#)).
- Use the **LED** screen to configure the LEDs ([Section 9.6 on page 51](#)).

## 9.3 Firmware Upload Screen

Find firmware at [www.zyxel.com](http://www.zyxel.com) in a file that (usually) uses the system model name with a "\*.bin" extension, e.g., "WRE2206.bin". The upload process uses HTTP (Hypertext Transfer Protocol) and may take up to two minutes. After a successful upload, the system will reboot.

Click **Maintenance > Tools**. Follow the instructions in this screen to upload firmware to your WRE2206.

Figure 35 Maintenance &gt; Tools &gt; Firmware

**Firmware Upgrade**

To upgrade the internal router firmware, browse to the location of the binary (.bin) upgrade file and click **Upload** . Upgrade files can be downloaded from website. If the upgrade file is compressed (.ZIP file), you must first extract the binary (.bin) file. In some cases, you may need to reconfigure.

File Path:  No file chosen

**On-line Firmware Upgrade**

You are currently using firmware version: V1.00(AAAG.5)C0.bin

The Latest Firmware Version	V1.00(AAAG.5)
Release Date	2013-05-09
Release Note	<a href="#">Click here to open</a>
Size	15073284

The following table describes the labels in this screen.

Table 19 Maintenance &gt; Tools &gt; Firmware

LABEL	DESCRIPTION
Firmware Upgrade	Use this section if you have already manually downloaded new firmware from the website. Remember that you must decompress compressed (.zip) files before you can upload them.
File Path	Click <b>Choose File</b> to find the location of the firmware .bin file you want to upload.
Upload	Click <b>Upload</b> to begin the upload process. This process may take up to two minutes.
On-line Firmware Upgrade	Use this section if you have want to check for new firmware on the website and the WRE2206 has an Internet connection.
Check for latest Firmware Now	The following fields display when you click this button.
You are currently using firmware version:	The firmware version consists of the trunk version number, model code, and release number. For example, V1.00(AAAG.5) means V1.00 is the trunk number, AAAG represents WRE2206, and 5 means the fifth release.
The Latest Firmware Version	Compare the release number in the previous field with the release number in this one to see if you have the latest firmware. In this example, V1.00(AAAG.5), the numbers are the same (5), so the WRE2206 already has the latest firmware.
Release Date	The date the firmware was issued is shown in year-month-date format.
Release Note	The release note shows what has changed (new features, bug fixes, known issues) in this firmware version. Check the Release Note before deciding to use new firmware.
Size	This is the size of the firmware in bytes. 15073234 is about 15 MB.
Do_Firmware_Upgrade	Click this button to download and upgrade the new firmware to the WRE2206.

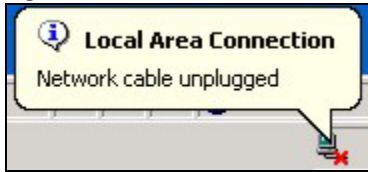
Note: Do not turn off the WRE2206 while firmware upload is in progress!

After you see the **Firmware Upgrading** screen, wait until the upgrade process is complete.

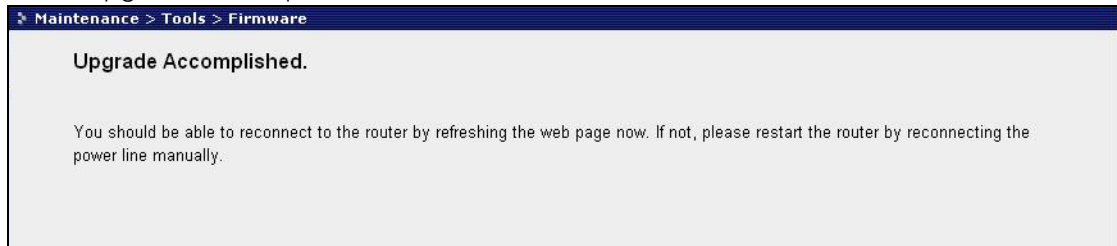


**Figure 36** Firmware Upgrading

The WRE2206 automatically restarts in this time causing a temporary network disconnect. In some operating systems, you may see the following icon on your desktop.

**Figure 37** Network Temporarily Disconnected

After the WRE2206 restarts, the **Upgrade Accomplished** screen appears.

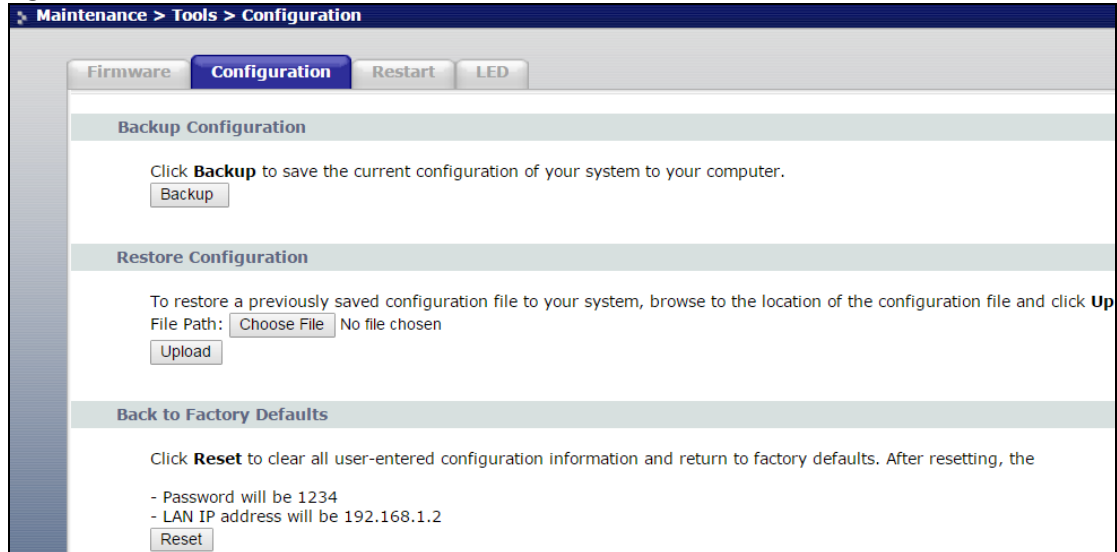
**Figure 38** Upgrade Accomplished

Refresh the web page and log in again and check your new firmware version in the **Status** screen.

## 9.4 Configuration Screen

Click **Maintenance > Tools > Configuration**. Information related to factory defaults, backup configuration, and restoring configuration appears as shown next.

Figure 39 Maintenance &gt; Tools &gt; Configuration



## 9.4.1 Backup Configuration

Backup configuration allows you to back up (save) the WRE2206's current configuration to a file on your computer. Once your WRE2206 is configured and functioning properly, it is highly recommended that you back up your configuration file before making configuration changes. The backup configuration file will be useful in case you need to return to your previous settings.

Click **Backup** to save the WRE2206's current configuration to your computer.

## 9.4.2 Restore Configuration

Restore configuration allows you to upload a new or previously saved configuration file from your computer to your WRE2206.

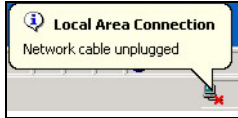
Table 20 Maintenance Restore Configuration

LABEL	DESCRIPTION
File Path	Type in the location of the file you want to upload in this field or click <b>Browse...</b> to find it.
Choose File	Click <b>Choose File</b> to find the file you want to upload. Remember that you must decompress compressed (.ZIP) files before you can upload them.
Upload	Click <b>Upload</b> to begin the upload process.

Note: Do not turn off the WRE2206 while configuration file upload is in progress.

After you see a "configuration upload successful" screen, you must then wait one minute before logging into the WRE2206 again.

The WRE2206 automatically restarts in this time causing a temporary network disconnect. In some operating systems, you may see the following icon on your desktop.

**Figure 40** Temporarily Disconnected

If you uploaded the default configuration file you may need to change the IP address of your computer to be in the same subnet as that of the default WRE2206 IP address (192.168.1.2). Refer to your operating system's help files for details on how to set up your computer's IP address.

### 9.4.3 Back to Factory Defaults

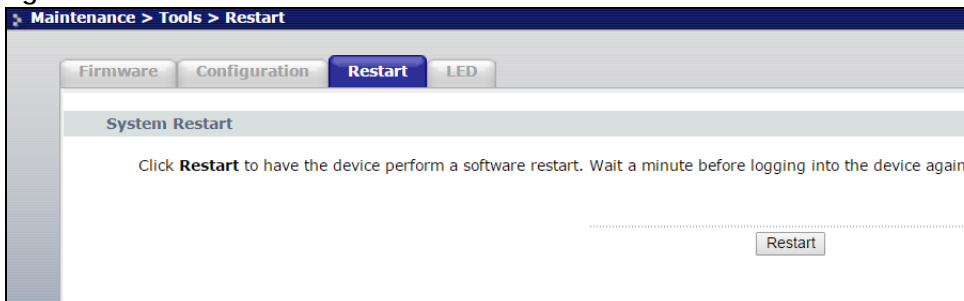
Pressing the **Reset** button on the Maintenance > Tools > Configuration screen clears all user-entered configuration information and returns the WRE2206 to its factory defaults.

You can also press the **WPS** button on the front panel for more than 10 seconds to reset the factory defaults of your WRE2206. Refer to [Section 2.3 on page 13](#) for more information on the resetting the WRE2206.

## 9.5 Restart Screen

System restart allows you to reboot the WRE2206 without turning the power off.

Click **Maintenance > Tools > Restart**. Click **Restart** to have the WRE2206 reboot. This does not affect the WRE2206's configuration.

**Figure 41** Maintenance > Tools > Restart

## 9.6 LED Screen

Click **Maintenance > Tools > LED**. Use this screen to configure which LEDs are enabled or disabled.

**Figure 42** Maintenance > Tools > LED

The following table describes the labels on the LED screen.

**Table 21** Maintenance > Tools > LED Screen

LABEL	DESCRIPTION
Enable LED OFF mode	Type in the location of the file you want to upload in this field or click <b>Browse...</b> to find it.
Turn off all LED	Select this to turn off all LEDs.
Turn off all LED except POWER LED	Select this to turn off all LEDs except the power LED.
Apply	Click <b>Apply</b> to save your changes back to the WRE2206.

# CHAPTER 10

## Troubleshooting

This chapter offers some suggestions to solve problems you might encounter. The potential problems are divided into the following categories.

- [Power, Hardware Connections, and LEDs](#)
- [WRE2206 Access and Login](#)
- [Internet Access](#)
- [Resetting the WRE2206 to Its Factory Defaults](#)
- [Wireless Problems](#)

### 10.1 Power, Hardware Connections, and LEDs

---

[The WRE2206 does not turn on. None of the LEDs turn on.](#)

---

- 1 Make sure the WRE2206 is plugged in to an appropriate power source. Make sure the power source is turned on.
- 2 Unplug and re-plug the WRE2206.
- 3 If the problem continues, contact the vendor.

---

[One of the LEDs does not behave as expected.](#)

---

- 1 Make sure you understand the normal behavior of the LED. See [Section 1.3 on page 9](#).
- 2 Make sure you understand how the LEDs are enabled or disabled. See [Section 9.6 on page 51](#).
- 3 Check the hardware connections. See the Quick Start Guide.
- 4 Inspect your cables for damage. Contact the vendor to replace any damaged cables.
- 5 Disconnect and re-connect the power adaptor to the WRE2206.
- 6 If the problem continues, contact the vendor.

---

## 10.2 WRE2206 Access and Login

---

I don't know the IP address of my WRE2206.

---

- 1 Click **Start > Run**, enter **cmd**, and then enter **Ping zyxelsetup**. You can find the MAC address on a label on the WRE2206.
- 2 The default URL is **http://zyxelsetup**. The default IP address is 192.168.1.2.
- 3 If you changed the IP address and have forgotten it, you might get the IP address of the WRE2206 by looking up the IP address of the default gateway for your computer. To do this in most Windows computers, click **Start > Run**, enter **cmd**, and then enter **ipconfig**. The IP address of the **Default Gateway** might be the IP address of the WRE2206 (it depends on the network), so enter this IP address in your Internet browser. Login (see the Quick Start Guide for instructions) and go to the **Device Information** table in the **Status** screen. Your WRE2206's IP address is available in the **Device Information** table.
  - If the **DHCP** setting under **LAN information** is **None**, your device has a fixed IP address.
  - If the **DHCP** setting under **LAN information** is **Client**, then your device receives an IP address from a DHCP server on the network.
- 4 If your WRE2206 is a DHCP client, you can find your IP address from the DHCP server. This information is only available from the DHCP server which allocates IP addresses on your network. Find this information directly from the DHCP server or contact your system administrator for more information.
- 5 Reset your WRE2206 to change all settings back to their default. This means your current settings are lost. See [Section 10.4 on page 56](#) in the **Troubleshooting** for information on resetting your WRE2206.

---

I forgot the username and password.

---

- 1 The default username is **admin** and default password is **1234**.
- 2 If this does not work, you have to reset the device to its factory defaults. See [Section 10.4 on page 56](#).

---

I cannot see or access the **Login** screen in the Web Configurator.

---

- 1 Make sure you are using the correct URL and IP address.
  - The default URL is **http://zyxelsetup**. The default IP address is 192.168.1.2.
  - If you changed the IP address, use the new IP address.
  - If you changed the IP address and have forgotten it, see the troubleshooting suggestions for [I don't know the IP address of my WRE2206](#).
- 2 Check the hardware connections, and make sure the LEDs are behaving as expected. See the Quick Start Guide.

- 3 Make sure your Internet browser does not block pop-up windows and has JavaScript and Java enabled.
- 4 Make sure your computer is in the same subnet as the WRE2206. (If you know that there are routers between your computer and the WRE2206, skip this step.)
  - If there is a DHCP server on your network, make sure your computer is using a dynamic IP address.
  - If there is no DHCP server on your network, make sure your computer's IP address is in the same subnet as the WRE2206.
- 5 Reset the device to its factory defaults, and try to access the WRE2206 with the default IP address.
- 6 If the problem continues, contact the network administrator or vendor, or try one of the advanced suggestions.

#### Advanced Suggestions

- If your computer is connected wirelessly, use a computer that is connected to a **LAN/ETHERNET** port.

---

I can see the [Login](#) screen, but I cannot log in to the WRE2206.

---

- 1 Make sure you have entered the password correctly. The default username is **admin** and default password is **1234**. This field is case-sensitive, so make sure [Caps Lock] is not on.
- 2 This can happen when you fail to log out properly from your last session. Try logging in again after 5 minutes.
- 3 Disconnect and re-connect the power adaptor or cord to the WRE2206.
- 4 If this does not work, you have to reset the device to its factory defaults. See [Section 10.4 on page 56](#).

## 10.3 Internet Access

---

I cannot access the Internet.

---

- 1 Check the hardware connections, and make sure the LEDs are behaving as expected. See the Quick Start Guide.
- 2 Try to connect directly to the AP. If you can access the Internet, check that the WRE2206 has associated with the AP by checking the **WLAN STA Information** SSID field shows the SSID of the AP. See [Section 6.4 on page 37](#).
- 3 If you are trying to access the Internet wirelessly, make sure the wireless settings in the wireless client are the same as the settings in the AP.
- 4 Disconnect all the cables from your device, and follow the directions in the Quick Start Guide again.

- 5 If the problem continues, contact your ISP.

---

I cannot access the Internet anymore. I had access to the Internet (with the WRE2206), but my Internet connection is not available anymore.

---

- 1 Check the hardware connections, and make sure the LEDs are behaving as expected. See the Quick Start Guide and [Section 1.3 on page 9](#).
- 2 Reboot the WRE2206.
- 3 Try to connect directly to the AP. If you can access the Internet, check that the WRE2206 has associated with the AP by checking the **WLAN STA Information** SSID field shows the SSID of the AP. See [Section 6.4 on page 37](#).
- 4 If the problem continues, contact your ISP.

---

The Internet connection is slow or intermittent.

---

- 1 There might be a lot of traffic on the network. Look at the LEDs, and check [Section 1.3 on page 9](#). If the WRE2206 is sending or receiving a lot of information, try closing some programs that use the Internet, especially peer-to-peer applications.
- 2 Check the signal strength. If the signal strength is low, try moving the WRE2206 closer to the AP if possible, and look around to see if there are any devices that might be interfering with the wireless network (for example, microwaves, other wireless networks, and so on).
- 3 Reboot the WRE2206.
- 4 If the problem continues, contact the network administrator or vendor, or try one of the advanced suggestions.

**Advanced Suggestion**

- Check the settings for QoS. If it is disabled, you might consider activating it.

## 10.4 Resetting the WRE2206 to Its Factory Defaults

If you reset the WRE2206, you lose all of the changes you have made. The WRE2206 re-loads its default settings, and the username/password resets to **admin/1234**. You have to make all of your changes again.

---

You will lose all of your changes when you reset the WRE2206 to its factory defaults.

---



To reset the WRE2206,

- 1 Make sure the power LED is on.
- 2 Press the **WPS** button for longer than 10 seconds to set the WRE2206 back to its factory-default configuration.

OR

- 3 Click **Maintenance > Tools > Restart** and then click **Restart**.

If the WRE2206 restarts automatically, wait for the WRE2206 to finish restarting, and log in to the Web Configurator. The username is **admin** and password is **1234**.

If the WRE2206 does not restart automatically, disconnect and reconnect the WRE2206's power. Then, follow the directions above again.

## 10.5 Wireless Problems

---

I cannot access the WRE2206 or ping any computer from the WLAN.

---

- 1 Make sure the wireless LAN is enabled on the WRE2206.
- 2 Make sure the wireless adapter on the wireless station is working properly.
- 3 Make sure the wireless adapter installed on your computer is IEEE 802.11 compatible and supports the same wireless standard as the WRE2206.
- 4 Make sure your computer (with a wireless adapter installed) is within the transmission range of the WRE2206.
- 5 Check that both the WRE2206 and your wireless station are using the same wireless and wireless security settings, and that both the WRE2206 and the AP are using the same wireless and wireless security settings.
- 6 Make sure traffic between the WLAN and the LAN is not blocked by the MAC Address List of the WRE2206. See [Section 6.5 on page 38](#).

# APPENDIX A

## Customer Support

In the event of problems that cannot be solved by using this manual, you should contact your vendor. If you cannot contact your vendor, then contact a Zyxel office for the region in which you bought the device.

See <http://www.zyxel.com/homepage.shtml> and also [http://www.zyxel.com/about\\_zyxel/zyxel\\_worldwide.shtml](http://www.zyxel.com/about_zyxel/zyxel_worldwide.shtml) for the latest information.

Please have the following information ready when you contact an office.

### Required Information

- Product model and serial number.
- Warranty Information.
- Date that you received your device.
- Brief description of the problem and the steps you took to solve it.

### Corporate Headquarters (Worldwide)

#### Taiwan

- Zyxel Communications Corporation
- <http://www.zyxel.com>

### Asia

#### China

- Zyxel Communications (Shanghai) Corp.
- Zyxel Communications (Beijing) Corp.
- Zyxel Communications (Tianjin) Corp.
- <http://www.zyxel.cn>

#### India

- Zyxel Technology India Pvt Ltd
- <http://www.zyxel.in>

#### Kazakhstan

- Zyxel Kazakhstan
- <http://www.zyxel.kz>

## **Korea**

- Zyxel Korea Corp.
- <http://www.zyxel.kr>

## **Malaysia**

- Zyxel Malaysia Sdn Bhd.
- <http://www.zyxel.com.my>

## **Pakistan**

- Zyxel Pakistan (Pvt.) Ltd.
- <http://www.zyxel.com.pk>

## **Philippines**

- Zyxel Philippines
- <http://www.zyxel.com.ph>

## **Singapore**

- Zyxel Singapore Pte Ltd.
- <http://www.zyxel.com.sg>

## **Taiwan**

- Zyxel Communications Corporation
- <http://www.zyxel.com/tw/zh/>

## **Thailand**

- Zyxel Thailand Co., Ltd
- <http://www.zyxel.co.th>

## **Vietnam**

- Zyxel Communications Corporation-Vietnam Office
- <http://www.zyxel.com/vn/vi>

## **Europe**

### **Austria**

- Zyxel Deutschland GmbH
- <http://www.zyxel.de>

### **Belarus**

- Zyxel BY
- <http://www.zyxel.by>

## **Belgium**

- Zyxel Communications B.V.
- <http://www.zyxel.com/be/nl/>
- <http://www.zyxel.com/be/fr/>

## **Bulgaria**

- Zyxel България
- <http://www.zyxel.com/bg/bg/>

## **Czech Republic**

- Zyxel Communications Czech s.r.o
- <http://www.zyxel.cz>

## **Denmark**

- Zyxel Communications A/S
- <http://www.zyxel.dk>

## **Estonia**

- Zyxel Estonia
- <http://www.zyxel.com/ee/et/>

## **Finland**

- Zyxel Communications
- <http://www.zyxel.fi>

## **France**

- Zyxel France
- <http://www.zyxel.fr>

## **Germany**

- Zyxel Deutschland GmbH
- <http://www.zyxel.de>

## **Hungary**

- Zyxel Hungary & SEE
- <http://www.zyxel.hu>

## **Italy**

- Zyxel Communications Italy
- <http://www.zyxel.it/>

## **Latvia**

- Zyxel Latvia
- <http://www.zyxel.com/lv/lv/homepage.shtml>

## **Lithuania**

- Zyxel Lithuania
- <http://www.zyxel.com/lt/lt/homepage.shtml>

## **Netherlands**

- Zyxel Benelux
- <http://www.zyxel.nl>

## **Norway**

- Zyxel Communications
- <http://www.zyxel.no>

## **Poland**

- Zyxel Communications Poland
- <http://www.zyxel.pl>

## **Romania**

- Zyxel Romania
- <http://www.zyxel.com/ro/ro>

## **Russia**

- Zyxel Russia
- <http://www.zyxel.ru>

## **Slovakia**

- Zyxel Communications Czech s.r.o. organizacna zlozka
- <http://www.zyxel.sk>

## **Spain**

- Zyxel Communications ES Ltd
- <http://www.zyxel.es>

## **Sweden**

- Zyxel Communications
- <http://www.zyxel.se>

## **Switzerland**

- Studerus AG

- <http://www.zyxel.ch/>

### **Turkey**

- Zyxel Turkey A.S.
- <http://www.zyxel.com.tr>

### **UK**

- Zyxel Communications UK Ltd.
- <http://www.zyxel.co.uk>

### **Ukraine**

- Zyxel Ukraine
- <http://www.ua.zyxel.com>

## **Latin America**

### **Argentina**

- Zyxel Communication Corporation
- <http://www.zyxel.com/ec/es/>

### **Brazil**

- Zyxel Communications Brasil Ltda.
- <https://www.zyxel.com/br/pt/>

### **Ecuador**

- Zyxel Communication Corporation
- <http://www.zyxel.com/ec/es/>

## **Middle East**

### **Israel**

- Zyxel Communication Corporation
- <http://il.zyxel.com/homepage.shtml>

### **Middle East**

- Zyxel Communication Corporation
- <http://www.zyxel.com/me/en/>

## North America

### USA

- Zyxel Communications, Inc. - North America Headquarters
- <http://www.zyxel.com/us/en/>

## Oceania

### Australia

- Zyxel Communications Corporation
- <http://www.zyxel.com/au/en/>

## Africa

### South Africa

- Nology (Pty) Ltd.
- <http://www.zyxel.co.za>

# APPENDIX B

## Legal Information

### Copyright

Copyright © 2018 by Zyxel Communications Corporation.

The contents of this publication may not be reproduced in any part or as a whole, transcribed, stored in a retrieval system, translated into any language, or transmitted in any form or by any means, electronic, mechanical, magnetic, optical, chemical, photocopying, manual, or otherwise, without the prior written permission of Zyxel Communications Corporation.

Published by Zyxel Communications Corporation. All rights reserved.

### Disclaimer

Zyxel does not assume any liability arising out of the application or use of any products, or software described herein. Neither does it convey any license under its patent rights nor the patent rights of others. Zyxel further reserves the right to make changes in any products described herein without notice. This publication is subject to change without notice.

### Regulatory Notice and Statement

#### UNITED STATES of AMERICA



The following information applies if you use the product within USA area.

#### FCC EMC Statement

- The device complies with Part 15 of FCC rules. Operation is subject to the following two conditions:
  - (1) This device may not cause harmful interference, and
  - (2) This device must accept any interference received, including interference that may cause undesired operation.
- Changes or modifications not expressly approved by the party responsible for compliance could void the user's authority to operate the device.
- This product has been tested and complies with the specifications for a Class B digital device, pursuant to Part 15 of the FCC Rules. These limits are designed to provide reasonable protection against harmful interference in a residential installation. This device generates, uses, and can radiate radio frequency energy and, if not installed and used according to the instructions, may cause harmful interference to radio communications. However, there is no guarantee that interference will not occur in a particular installation.
- If this device does cause harmful interference to radio or television reception, which is found by turning the device off and on, the user is encouraged to try to correct the interference by one or more of the following measures:
  - Reorient or relocate the receiving antenna
  - Increase the separation between the devices
  - Connect the equipment to an outlet other than the receiver's
  - Consult a dealer or an experienced radio/TV technician for assistance

The following information applies if you use the product with RF function within USA area.

#### FCC Radiation Exposure Statement

- This device complies with FCC RF radiation exposure limits set forth for an uncontrolled environment.
- This transmitter must be at least 20 cm from the user and must not be co-located or operating in conjunction with any other antenna or transmitter.
- Operation of this device is restricted to indoor use only, except for relevant user's manual mention that this device can be installed into the external environment.

#### CANADA

The following information applies if you use the product within Canada area.

#### Industry Canada ICES statement

CAN ICES-3 (B)/NMB-3(B)



### Industry Canada RSS-GEN & RSS-247 statement

- This device complies with Industry Canada license-exempt RSS standard(s). Operation is subject to the following two conditions: (1) this device may not cause interference, and (2) this device must accept any interference, including interference that may cause undesired operation of the device.
- This radio transmitter (2468C-WRE2206) has been approved by Industry Canada to operate with the antenna types listed below with the maximum permissible gain and required antenna impedance for each antenna type indicated. Antenna types not included in this list, having a gain greater than the maximum gain indicated for that type, are strictly prohibited for use with this device.

### Antenna Information

TYPE	MANUFACTURER	GAIN	CONNECTOR
PIFA	LYNwave	2 dBi	N/A

If the product with 5G wireless function operating in 5150-5250 MHz and 5725-5850 MHz, the following attention must be paid,

- The device for operation in the band 5150-5250 MHz is only for indoor use to reduce the potential for harmful interference to co-channel mobile satellite systems.
- For devices with detachable antenna(s), the maximum antenna gain permitted for devices in the band 5725-5850 MHz shall be such that the equipment still complies with the e.i.r.p. limits specified for point-to-point and non-point-to-point operation as appropriate; and
- The worst-case tilt angle(s) necessary to remain compliant with the e.i.r.p. elevation mask requirement set forth in Section 6.2.2(3) of RSS 247 shall be clearly indicated.

If the product with 5G wireless function operating in 5250-5350 MHz and 5470-5725 MHz, the following attention must be paid.

- For devices with detachable antenna(s), the maximum antenna gain permitted for devices in the bands 5250-5350 MHz and 5470-5725 MHz shall be such that the equipment still complies with the e.i.r.p. limit.
- Le présent appareil est conforme aux CNR d'Industrie Canada applicables aux appareils radio exempts de licence. L'exploitation est autorisée aux deux conditions suivantes : (1) l'appareil ne doit pas produire de brouillage, et (2) l'utilisateur de l'appareil doit accepter tout brouillage radioélectrique subi, même si le brouillage est susceptible d'en compromettre le fonctionnement.
- Le présent émetteur radio (2468C-WRE2206) de modèle s'il fait partie du matériel de catégorie I) a été approuvé par Industrie Canada pour fonctionner avec les types d'antenne énumérés ci-dessous et ayant un gain admissible maximal et l'impédance requise pour chaque type d'antenne. Les types d'antenne non inclus dans cette liste, ou dont le gain est supérieur au gain maximal indiqué, sont strictement interdits pour l'exploitation de l'émetteur.

### Informations Antenne

TYPE	FABRICANT	GAIN	CONNECTEUR
PIFA	LYNwave	2 dBi	N/A

Lorsque la fonction sans fil 5G fonctionnant en 5150-5250 MHz and 5725-5850 MHz est activée pour ce produit, il est nécessaire de porter une attention particulière aux choses suivantes

- Les dispositifs fonctionnant dans la bande 5150-5250 MHz sont réservés uniquement pour une utilisation à l'intérieur afin de réduire les risques de brouillage préjudiciable aux systèmes de satellites mobiles utilisant les mêmes canaux;
- Pour les dispositifs munis d'antennes amovibles, le gain maximal d'antenne permis (pour les dispositifs utilisant la bande de 5 725 à 5 850 MHz) doit être conforme à la limite de la p.i.r.e. spécifiée pour l'exploitation point à point et l'exploitation non point à point, selon le cas;
- Les pires angles d'inclinaison nécessaires pour rester conforme à l'exigence de la p.i.r.e. applicable au masque d'élévation, et énoncée à la section 6.2.2 3) du CNR-247, doivent être clairement indiqués.

Lorsque la fonction sans fil 5G fonctionnant en 5250-5350 MHz et 5470-5725 MHz est activée pour ce produit, il est nécessaire de porter une attention particulière aux choses suivantes.

- Pour les dispositifs munis d'antennes amovibles, le gain maximal d'antenne permis pour les dispositifs utilisant les bandes de 5 250 à 5 350 MHz et de 5 470 à 5 725 MHz doit être conforme à la limite de la p.i.r.e.

### Industry Canada radiation exposure statement

This device complies with IC radiation exposure limits set forth for an uncontrolled environment. This device should be installed and operated with a minimum distance of 20 cm between the radiator and your body.

### Déclaration d'exposition aux radiations:

Cet équipement est conforme aux limites d'exposition aux rayonnements IC établies pour un environnement non contrôlé. Cet équipement doit être installé et utilisé avec un minimum de 20 cm de distance entre la source de rayonnement et votre corps.

## EUROPEAN UNION



The following information applies if you use the product within the European Union.

### Declaration of Conformity with Regard to EU Directive 2014/53/EU (Radio Equipment Directive, RED)

- Compliance information for wireless products relevant to the EU and other Countries following the EU Directive 2014/53/EU (RED). And this product may be used in all EU countries (and other countries following the EU Directive 2014/53/EU) without any limitation except for the countries mentioned below table:
- In the majority of the EU and other European countries, the 5GHz bands have been made available for the use of wireless local area networks (LANs). Later in this document you will find an overview of countries in which additional restrictions or requirements or both are applicable. The requirements for any country may evolve. Zyxel recommends that you check with the local authorities for the latest status of their national regulations for the 5GHz wireless LANs.
- If this device for operation in the band 5150-5350 MHz, it is for indoor use only.
- This equipment should be installed and operated with a minimum distance of 20cm between the radio equipment and your body.
- The maximum RF power operating for each band as follows:
  - the band 2,400 to 2,483.5 MHz is 98.86 mW,

Български (Bulgarian)	<p>С настоящото Zyxel декларира, че това оборудване е в съответствие със съществените изисквания и другите приложими разпоредбите на Директива 2014/53/ЕС.</p> <p><b>National Restrictions</b></p> <ul style="list-style-type: none"> <li>• The Belgian Institute for Postal Services and Telecommunications (BIPT) must be notified of any outdoor wireless link having a range exceeding 300 meters. Please check <a href="http://www.bipt.be">http://www.bipt.be</a> for more details.</li> <li>• Draadloze verbindingen voor buitengebruik en met een reikwijdte van meer dan 300 meter dienen aangemeld te worden bij het Belgisch Instituut voor postdiensten en telecommunicatie (BIPT). Zie <a href="http://www.bipt.be">http://www.bipt.be</a> voor meer gegevens.</li> <li>• Les liaisons sans fil pour une utilisation en extérieur d'une distance supérieure à 300 mètres doivent être notifiées à l'Institut Belge des services Postaux et des Télécommunications (IBPT). Visitez <a href="http://www.ibpt.be">http://www.ibpt.be</a> pour de plus amples détails.</li> </ul>
Español (Spanish)	Por medio de la presente Zyxel declara que el equipo cumple con los requisitos esenciales y cualesquiera otras disposiciones aplicables o exigibles de la Directiva 2014/53/UE..
Čeština (Czech)	Zyxel tímto prohlašuje, že tento zařízení je ve shodě se základními požadavky a dalšími příslušnými ustanoveními směrnice 2014/53/EU.
Dansk (Danish)	<p>Undertegnede Zyxel erklærer herved, at følgende udstyr overholder de væsentlige krav og øvrige relevante krav i direktiv 2014/53/EU.</p> <p><b>National Restrictions</b></p> <ul style="list-style-type: none"> <li>• In Denmark, the band 5150 - 5350 MHz is also allowed for outdoor usage.</li> <li>• I Danmark må frekvensbåndet 5150 - 5350 også anvendes udendørs.</li> </ul>
Deutsch (German)	Hiermit erklärt Zyxel, dass sich das Gerät Ausstattung in Übereinstimmung mit den grundlegenden Anforderungen und den übrigen einschlägigen Bestimmungen der Richtlinie 2014/53/EU befindet.
Eesti keel (Estonian)	Käesolevaga kinnitab Zyxel seadme seadmed vastavust direktiivi 2014/53/EL põhinõuetele ja nimetatud direktiivist tulenevatele teistele asjakohastele sätetele.
Ελληνικά (Greek)	ΜΕ ΤΗΝ ΠΑΡΟΥΣΑ Zyxel ΔΗΛΩΝΕΙ ΟΤΙ ΕΞΟΤΙΣΜΟΣ ΣΥΜΜΟΡΦΩΝΕΤΑΙ ΠΡΟΣ ΤΙΣ ΟΥΣΙΩΔΕΙΣ ΑΠΑΙΤΗΣΕΙΣ ΚΑΙ ΤΙΣ ΛΟΙΠΕΣ ΣΧΕΤΙΚΕΣ ΔΙΑΤΑΞΕΙΣ ΤΗΣ ΟΔΗΓΙΑΣ 2014/53/ΕΕ.
English	Hereby, Zyxel declares that this device is in compliance with the essential requirements and other relevant provisions of Directive 2014/53/EU.
Français (French)	Par la présente Zyxel déclare que l'appareil équipements est conforme aux exigences essentielles et aux autres dispositions pertinentes de la directive 2014/53/UE.
Hrvatski (Croatian)	Zyxel ovime izjavljuje da je radijska oprema tipa u skladu s Direktivom 2014/53/UE.
Íslenska (Icelandic)	Hér með lýsir, Zyxel því yfir að þessi búnaður er í samræmi við grunnkröfur og önnur viðeigandi ákvæði tilskipunar 2014/53/UE.
Italiano (Italian)	<p>Con la presente Zyxel dichiara che questo attrezzatura è conforme ai requisiti essenziali ed alle altre disposizioni pertinenti stabilite dalla direttiva 2014/53/UE.</p> <p><b>National Restrictions</b></p> <ul style="list-style-type: none"> <li>• This product meets the National Radio Interface and the requirements specified in the National Frequency Allocation Table for Italy. Unless this wireless LAN product is operating within the boundaries of the owner's property, its use requires a "general authorization." Please check <a href="http://www.sviluppoeconomico.gov.it/">http://www.sviluppoeconomico.gov.it/</a> for more details.</li> <li>• Questo prodotto è conforme alla specifiche di Interfaccia Radio Nazionali e rispetta il Piano Nazionale di ripartizione delle frequenze in Italia. Se non viene installato all'interno del proprio fondo, l'utilizzo di prodotti Wireless LAN richiede una "Autorizzazione Generale". Consultare <a href="http://www.sviluppoeconomico.gov.it/">http://www.sviluppoeconomico.gov.it/</a> per maggiori dettagli.</li> </ul>
Latviešu valoda (Latvian)	<p>Ar šo Zyxel deklarē, ka iekārtas atbilst Direktīvas 2014/53/ES būtiskajām prasībām un citiem ar to saistītajiem noteikumiem.</p> <p><b>National Restrictions</b></p> <ul style="list-style-type: none"> <li>• The outdoor usage of the 2.4 GHz band requires an authorization from the Electronic Communications Office. Please check <a href="http://www.esd.lv">http://www.esd.lv</a> for more details.</li> <li>• 2.4 GHz frekvenču joslas izmantošanai ārpus telpām nepieciešama atļauja no Elektronisko sakaru direkcijas. Vairāk informācijas: <a href="http://www.esd.lv">http://www.esd.lv</a>.</li> </ul>
Lietuvių kalba (Lithuanian)	Šiuo Zyxel deklaruoja, kad šis įranga atitinka esminius reikalavimus ir kitas 2014/53/ES Direktyvos nuostatas.
Magyar (Hungarian)	Alulírott, Zyxel nyilatkozom, hogy a berendezés megfelel a vonatkozó alapvető követelményeknek és az 2014/53/EU irányelv egyéb előírásainak.

Malti (Maltese)	Hawnhekk, Zyxel, jiddikjara li dan taghmir jikkonforma mal-ftigijiet essenzjali u ma provvedimenti oħrajn relevanti li hemm fid-Dirrettiva 2014/53/UE.
Nederlands (Dutch)	Hierbij verklaart Zyxel dat het toestel uitrusting in overeenstemming is met de essentiële eisen en de andere relevante bepalingen van richtlijn 2014/53/EU.
Polski (Polish)	Niniejszym Zyxel oświadcza, że sprzęt jest zgodny z zasadniczymi wymogami oraz pozostałymi stosownymi postanowieniami Dyrektywy 2014/53/UE.
Português (Portuguese)	Zyxel declara que este equipamento está conforme com os requisitos essenciais e outras disposições da Directiva 2014/53/UE.
Română (Romanian)	Prin prezenta, Zyxel declară că acest echipament este în conformitate cu cerințele esențiale și alte prevederi relevante ale Directivei 2014/53/UE.
Slovenčina (Slovak)	Zyxel týmto vyhlasuje, že zariadenia spĺňa základné požiadavky a všetky príslušné ustanovenia Smernice 2014/53/EÚ.
Slovenščina (Slovene)	Zyxel izjavlja, da je ta oprema v skladu z bistvenimi zahtevami in ostalimi relevantnimi določili direktive 2014/53/EU.
Suomi (Finnish)	Zyxel vakuuttaa täten että laitteet tyyppinen laite on direktiivin 2014/53/EU oleellisten vaatimusten ja sitä koskevien direktiivin muiden ehtojen mukainen.
Svenska (Swedish)	Härmed intygar Zyxel att denna utrustning står i överensstämmelse med de väsentliga egenskapskrav och övriga relevanta bestämmelser som framgår av direktiv 2014/53/EU.
Norsk (Norwegian)	Erklærer herved Zyxel at dette utstyret er i samsvar med de grunnleggende kravene og andre relevante bestemmelser i direktiv 2014/53/EU.

**Notes:**

- Although Norway, Switzerland and Liechtenstein are not EU member states, the EU Directive 2014/53/EU has also been implemented in those countries.

The regulatory limits for maximum output power are specified in EIRP. The EIRP level (in dBm) of a device can be calculated by adding the gain of the antenna used (specified in dBi) to the output power available at the connector (specified in dBm). **List of national codes**

COUNTRY	ISO 3166 2 LETTER CODE	COUNTRY	ISO 3166 2 LETTER CODE
Austria	AT	Liechtenstein	LI
Belgium	BE	Lithuania	LT
Bulgaria	BG	Luxembourg	LU
Croatia	HR	Malta	MT
Cyprus	CY	Netherlands	NL
Czech Republic	CZ	Norway	NO
Denmark	DK	Poland	PL
Estonia	EE	Portugal	PT
Finland	FI	Romania	RO
France	FR	Serbia	RS
Germany	DE	Slovakia	SK
Greece	GR	Slovenia	SI
Hungary	HU	Spain	ES
Iceland	IS	Switzerland	CH
Ireland	IE	Sweden	SE
Italy	IT	Turkey	TR
Latvia	LV	United Kingdom	GB

**Safety Warnings**

- Do not use this product near water, for example, in a wet basement or near a swimming pool.
- Do not expose your device to dampness, dust or corrosive liquids.
- Do not store things on the device.
- Do not obstruct the device ventilation slots as insufficient airflow may harm your device. For example, do not place the device in an enclosed space such as a box or on a very soft surface such as a bed or sofa.
- Do not install, use, or service this device during a thunderstorm. There is a remote risk of electric shock from lightning.
- Connect ONLY suitable accessories to the device.
- Do not open the device or unit. Opening or removing covers can expose you to dangerous high voltage points or other risks. ONLY qualified service personnel should service or disassemble this device. Please contact your vendor for further information.
- Make sure to connect the cables to the correct ports.
- Place connecting cables carefully so that no one will step on them or stumble over them.
- Always disconnect all cables from this device before servicing or disassembling.

- Do not remove the plug and connect it to a power outlet by itself; always attach the plug to the power adaptor first before connecting it to a power outlet.
- Do not allow anything to rest on the power adaptor or cord and do NOT place the product where anyone can walk on the power adaptor or cord.
- Please use the provided or designated connection cables/power cables/ adaptors. Connect it to the right supply voltage (for example, 110V AC in North America or 230V AC in Europe). If the power adaptor or cord is damaged, it might cause electrocution. Remove it from the device and the power source, repairing the power adapter or cord is prohibited. Contact your local vendor to order a new one.
- Do not use the device outside, and make sure all the connections are indoors. There is a remote risk of electric shock from lightning.
- CAUTION: Risk of explosion if battery is replaced by an incorrect type, dispose of used batteries according to the instruction. Dispose them at the applicable collection point for the recycling of electrical and electronic devices. For detailed information about recycling of this product, please contact your local city office, your household waste disposal service or the store where you purchased the product.
- The following warning statements apply, where the disconnect device is not incorporated in the device or where the plug on the power supply cord is intended to serve as the disconnect device.
  - For permanently connected devices, a readily accessible disconnect device shall be incorporated external to the device;
  - For pluggable devices, the socket-outlet shall be installed near the device and shall be easily accessible.

## Environment Statement

### ErP (Energy-related Products)

Zyxel products put on the EU market in compliance with the requirement of the European Parliament and the Council published Directive 2009/125/EC establishing a framework for the setting of ecodesign requirements for energy-related products (recast), so called as "ErP Directive (Energy-related Products directive) as well as ecodesign requirement laid down in applicable implementing measures, power consumption has satisfied regulation requirements which are:

- Network standby power consumption < 8W, and/or
- Off mode power consumption < 0.5W, and/or
- Standby mode power consumption < 0.5W.

(Wireless setting, please refer to "Wireless" chapter for more detail.)

### European Union - Disposal and Recycling Information

The symbol below means that according to local regulations your product and/or its battery shall be disposed of separately from domestic waste. If this product is end of life, take it to a recycling station designated by local authorities. At the time of disposal, the separate collection of your product and/or its battery will help save natural resources and ensure that the environment is sustainable development.

Die folgende Symbol bedeutet, dass Ihr Produkt und/oder seine Batterie gemäß den örtlichen Bestimmungen getrennt vom Hausmüll entsorgt werden muss. Wenden Sie sich an eine Recyclingstation, wenn dieses Produkt das Ende seiner Lebensdauer erreicht hat. Zum Zeitpunkt der Entsorgung wird die getrennte Sammlung von Produkt und/oder seiner Batterie dazu beitragen, natürliche Ressourcen zu sparen und die Umwelt und die menschliche Gesundheit zu schützen.

El símbolo de abajo indica que según las regulaciones locales, su producto y/o su batería deberán depositarse como basura separada de la doméstica. Cuando este producto alcance el final de su vida útil, llévelo a un punto limpio. Cuando llegue el momento de desechar el producto, la recogida por separado éste y/o su batería ayudará a salvar los recursos naturales y a proteger la salud humana y medioambiental.

Le symbole ci-dessous signifie que selon les réglementations locales votre produit et/ou sa batterie doivent être éliminés séparément des ordures ménagères. Lorsque ce produit atteint sa fin de vie, amenez-le à un centre de recyclage. Au moment de la mise au rebut, la collecte séparée de votre produit et/ou de sa batterie aidera à économiser les ressources naturelles et protéger l'environnement et la santé humaine.

Il simbolo sotto significa che secondo i regolamenti locali il vostro prodotto e/o batteria deve essere smaltito separatamente dai rifiuti domestici. Quando questo prodotto raggiunge la fine della vita di servizio portarlo a una stazione di riciclaggio. Al momento dello smaltimento, la raccolta separata del vostro prodotto e/o della sua batteria aiuta a risparmiare risorse naturali e a proteggere l'ambiente e la salute umana.

Symbolen innebär att enligt lokal lagstiftning ska produkten och/eller dess batteri kastas separat från hushållsavfallet. När den här produkten når slutet av sin livslängd ska du ta den till en återvinningsstation. Vid tiden för kasseringen bidrar du till en bättre miljö och mänsklig hälsa genom att göra dig av med den på ett återvinningsställe.



## 台灣



以下訊息僅適用於產品具有無線功能且銷售至台灣地區

- 第十二條 經型式認證合格之低功率射頻電機，非經許可，公司，商號或使用者均不得擅自變更頻率、加大功率或變更原設計之特性及功能。
- 第十四條 低功率射頻電機之使用不得影響飛航安全及干擾合法通信；經發現有干擾現象時，應立即停用，並改善至無干擾時方得繼續使用。前項合法通信，指依電信法規定作業之無線電通信。低功率射頻電機須忍受合法通信或工業、科學及醫療用電波輻射性電機設備之干擾。
- 無線資訊傳輸設備忍受合法通信之干擾且不得干擾合法通信；如造成干擾，應立即停用，俟無干擾之虞，始得繼續使用。
- 無線資訊傳輸設備的製造廠商應確保頻率穩定性，如依製造廠商使用手冊上所述正常操作，發射的信號應維持於操作頻帶中。
- 使用無線產品時，應避免影響附近雷達系統之操作。
- 若使用高增益指向性天線，該產品僅應用於固定式點對點系統。

以下訊息僅適用於產品屬於專業安裝並銷售至台灣地區

- 本器材須經專業工程人員安裝及設定，始得設置使用，且不得直接販售給一般消費者。





安全警告 - 為了您的安全，請先閱讀以下警告及指示：

- 請勿將此產品接近水、火焰或放置在高溫的環境。
- 避免設備接觸：
  - 任何液體 - 切勿讓設備接觸水、雨水、高濕度、污水腐蝕性的液體或其他水份。
  - 灰塵及污物 - 切勿接觸灰塵、污物、沙土、食物或其他不合適的材料。
- 雷雨天氣時，不要安裝，使用或維修此設備。有遭受電擊的風險。
- 切勿重摔或撞擊設備，並勿使用不正確的電源變壓器。
- 若接上不正確的電源變壓器會有爆炸的風險。
- 請勿隨意更換產品內的電池。
- 如果更換不正確之電池型式，會有爆炸的風險，請依製造商說明書處理使用過之電池。
- 請將廢電池丟棄在適當的電器或電子設備回收處。
- 請勿將設備解體。
- 請勿阻礙設備的散熱孔，空氣對流不足將會造成設備損害。
- 請插在正確的電壓供給插座（如：北美 / 台灣電壓 110V AC，歐洲是 230V AC）。
- 假若電源變壓器或電源變壓器的纜線損壞，請從插座拔除，若您還繼續插電使用，會有觸電死亡的風險。
- 請勿試圖修理電源變壓器或電源變壓器的纜線，若有毀損，請直接聯絡您購買的店家，購買一個新的電源變壓器。
- 請勿將此設備安裝於室外，此設備僅適合放置於室內。
- 請勿隨一般垃圾丟棄。
- 請參閱產品背貼上的設備額定功率。
- 請參考產品型錄或是彩盒上的作業溫度。
- 產品沒有斷電裝置或者採用電源線的插頭視為斷電裝置的一部分，以下警語將適用：
  - 對永久連接之設備，在設備外部須安裝可觸及之斷電裝置；
  - 對插接式之設備，插座必須接近安裝之地點而且是易於觸及的。

## About the Symbols

Various symbols are used in this product to ensure correct usage, to prevent danger to the user and others, and to prevent property damage. The meaning of these symbols are described below. It is important that you read these descriptions thoroughly and fully understand the contents.

### Explanation of the Symbols

SYMBOL	EXPLANATION
	Alternating current (AC): AC is an electric current in which the flow of electric charge periodically reverses direction.
	Direct current (DC): DC is the unidirectional flow or movement of electric charge carriers.
	Earth; ground: A wiring terminal intended for connection of a Protective Earthing Conductor.
	Class II equipment: The method of protection against electric shock in the case of class II equipment is either double insulation or reinforced insulation.

### Viewing Certifications

Go to <http://www.zyxel.com> to view this product's documentation and certifications.

### Zyxel Limited Warranty

Zyxel warrants to the original end user (purchaser) that this product is free from any defects in material or workmanship for a specific period (the Warranty Period) from the date of purchase. The Warranty Period varies by region. Check with your vendor and/or the authorized Zyxel local distributor for details about the Warranty Period of this product. During the warranty period, and upon proof of purchase, should the product have indications of failure due to faulty workmanship and/or materials, Zyxel will, at its discretion, repair or replace the defective products or components without charge for either parts or labor, and to whatever extent it shall deem necessary to restore the product or components to proper operating condition. Any replacement will consist of a new or re-manufactured functionally equivalent product of equal or higher value, and will be solely at the discretion of Zyxel. This warranty shall not apply if the product has been modified, misused, tampered with, damaged by an act of God, or subjected to abnormal working conditions.

#### Note

Repair or replacement, as provided under this warranty, is the exclusive remedy of the purchaser. This warranty is in lieu of all other warranties, express or implied, including any implied warranty of merchantability or fitness for a particular use or purpose. Zyxel shall in no event be held liable for indirect or consequential damages of any kind to the purchaser.

To obtain the services of this warranty, contact your vendor. You may also refer to the warranty policy for the region in which you bought the device at [http://www.zyxel.com/web/support\\_warranty\\_info.php](http://www.zyxel.com/web/support_warranty_info.php).

### Registration

Register your product online to receive e-mail notices of firmware upgrades and information at [www.zyxel.com](http://www.zyxel.com) for global products, or at [www.us.zyxel.com](http://www.us.zyxel.com) for North American products.

### Open Source Licenses

This product contains in part some free software distributed under GPL license terms and/or GPL like licenses. Open source licenses are provided with the firmware package. You can download the latest firmware at [www.zyxel.com](http://www.zyxel.com). To obtain the source code covered under those Licenses, please contact [support@zyxel.com.tw](mailto:support@zyxel.com.tw) to get it.

# Index

## B

Backup configuration [50](#)

## C

certifications [67](#)  
  viewing [70](#)  
Channel [21](#)  
Configuration  
  backup [50](#)  
  reset the factory defaults [51](#)  
  restore [50](#)  
contact information [58](#)  
copyright [64](#)  
CPU usage [21](#)  
customer support [58](#)

## D

disclaimer [64](#)  
duplex setting [21](#)

## E

encryption [36](#)  
  key [36](#)

## F

Firmware upload [47](#)  
  file extension  
  using HTTP  
firmware version [21](#)

## G

General wireless LAN screen [37](#)

## I

IP Address [45](#)

## L

LAN setup [44](#)  
Link type [21](#)

## M

MAC [38](#)  
MAC address [36](#)  
MAC address filtering [38](#)  
MAC Address List [36, 38](#)  
managing the device  
  good habits [9](#)  
Media access control [38](#)  
Memory usage [21](#)

## N

Navigation Panel [22](#)

## O

overview [8](#)

**P**

port speed [21](#)

**Q**

Quality of Service (QoS) [40](#)

**R**

Reset the device [13](#)

Restore configuration [50](#)

RTS/CTS Threshold [39](#)

**S**

Service Set [37](#)

Service Set IDentification [15, 37, 43](#)

Service Set IDentity. See SSID.

SSID [15, 21, 35, 37, 43](#)

Subnet Mask [45](#)

System General Setup [46](#)

System restart [51](#)

**W**

warranty [70](#)

note [70](#)

Web Configurator

how to access [12](#)

Overview [12](#)

wireless channel [57](#)

wireless LAN [57](#)

Wireless LAN wizard [14](#)

Wireless network [36](#)

basic guidelines [35](#)

encryption [36](#)

security [35](#)

SSID [35](#)

Wireless security [35](#)

overview [36](#)

troubleshooting [57](#)

type [36](#)

Wireless tutorial [24](#)

WPS [24](#)

Wizard setup [14](#)

complete [19](#)

wireless LAN [14](#)

WPS button [10, 13](#)