

TP-LINK®

User Guide

TD-W8960N

300Mbps Wireless N ADSL2+ Modem Router



COPYRIGHT & TRADEMARKS

Specifications are subject to change without notice. **TP-LINK**[®] is a registered trademark of TP-LINK TECHNOLOGIES CO., LTD. Other brands and product names are trademarks or registered trademarks of their respective holders.

No part of the specifications may be reproduced in any form or by any means or used to make any derivative such as translation, transformation, or adaptation without permission from TP-LINK TECHNOLOGIES CO., LTD. Copyright © 2011 TP-LINK TECHNOLOGIES CO., LTD. All rights reserved.

<http://www.tp-link.com>

FCC STATEMENT



This equipment has been tested and found to comply with the limits for a Class B digital device, pursuant to part 15 of the FCC Rules. These limits are designed to provide reasonable protection against harmful interference in a residential installation. This equipment generates, uses and can radiate radio frequency energy and, if not installed and used in accordance with the instructions, may cause harmful interference to radio communications. However, there is no guarantee that interference will not occur in a particular installation. If this equipment does cause harmful interference to radio or television reception, which can be determined by turning the equipment off and on, the user is encouraged to try to correct the interference by one or more of the following measures:

- Reorient or relocate the receiving antenna.
- Increase the separation between the equipment and receiver.
- Connect the equipment into an outlet on a circuit different from that to which the receiver is connected.
- Consult the dealer or an experienced radio/ TV technician for help.

This device complies with part 15 of the FCC Rules. Operation is subject to the following two conditions:

- 1) This device may not cause harmful interference.
- 2) This device must accept any interference received, including interference that may cause undesired operation.

Any changes or modifications not expressly approved by the party responsible for compliance could void the user's authority to operate the equipment.

Note: The manufacturer is not responsible for any radio or tv interference caused by unauthorized modifications to this equipment. Such modifications could void the user's authority to operate the equipment.

FCC RF Radiation Exposure Statement

This equipment complies with FCC RF radiation exposure limits set forth for an uncontrolled environment. This device and its antenna must not be co-located or operating in conjunction with any other antenna or transmitter.

"To comply with FCC RF exposure compliance requirements, this grant is applicable to only Mobile Configurations. The antennas used for this transmitter must be installed to provide a separation distance of at least 20 cm from all persons and must not be co-located or operating in conjunction with any other antenna or transmitter."

CE Mark Warning

CE 1588 ⚠

This is a class B product. In a domestic environment, this product may cause radio interference, in which case the user may be required to take adequate measures.

National Restrictions

This device is intended for home and office use in all EU countries (and other countries following the EU directive 1999/5/EC) without any limitation except for the countries mentioned below:

Country	Restriction	Reason/remark
Bulgaria	None	General authorization required for outdoor use and public service
France	Outdoor use limited to 10 mW e.i.r.p. within the band 2454-2483.5 MHz	Military Radiolocation use. Refarming of the 2.4 GHz band has been ongoing in recent years to allow current relaxed regulation. Full implementation planned 2012
Italy	None	If used outside of own premises, general authorization is required
Luxembourg	None	General authorization required for network and service supply(not for spectrum)
Norway	Implemented	This subsection does not apply for the geographical area within a radius of 20 km from the centre of Ny-Ålesund
Russian Federation	None	Only for indoor applications

Note: Please don't use the product outdoors in France.

This device has been designed to operate with the antennas listed below, and having a maximum gain of 3 dBi. Antennas not included in this list or having a gain greater than 3 dBi are strictly prohibited for use with this device. The required antenna impedance is 50 ohms.

To reduce potential radio interference to other users, the antenna type and its gain should be so chosen that the equivalent isotropically radiated power (e.i.r.p.) is not more than that permitted for successful communication.

DECLARATION OF CONFORMITY

For the following equipment:

Product Description: **300Mbps Wireless N ADSL2+ Modem Router**

Model No.: **TD-W8960N**

Trademark: **TP-LINK**

We declare under our own responsibility that the above products satisfy all the technical regulations applicable to the product within the scope of Council Directives:

Directives 1999/5/EC

The above product is in conformity with the following standards or other normative documents

ETSI EN 300 328 V1.7.1: 2006

ETSI EN 301 489-1 V1.8.1:2008& ETSI EN 301 489-17 V2.1.1:2009

EN 61000-3-2:2006+A1:2009+A2:2009

EN 61000-3-3:2008

EN60950-1:2006+A11:2009

Recommendation 1999/519/EC

EN62311:2008

Directives 2004/108/EC

The above product is in conformity with the following standards or other normative documents

EN 55022:2006 +A1:2007

EN 55024:1998+A1:2001+A2:2003

EN 61000-3-2:2006+A1:2009+A2:2009

EN 61000-3-3:2008

Directives 2006/95/EC

The above product is in conformity with the following standards or other normative documents

EN60950-1:2006+A11:2009

Person is responsible for marking this declaration:



Yang Hongliang

Product Manager of International Business

South Building, No.5 Keyuan Road, Central Zone, Science & Technology Park, Nanshan,
Shenzhen, P. R. China

CONTENTS

Package Contents	1
Chapter 1. Product Overview.....	2
1.1 Overview of the Router	2
1.2 Main Features	3
1.3 Panel Layout	4
1.3.1 The Front Panel	4
1.3.2 The Back Panel.....	5
Chapter 2. Connecting the Router.....	6
2.1 System Requirements.....	6
2.2 Installation Environment Requirements	6
2.3 Connecting the Router	6
Chapter 3. Quick Installation Guide	8
3.1 Configuring the PC.....	8
3.2 Quick Installation Guide	11
Chapter 4. Configuring the Router	16
4.1 Login	16
4.2 Device Info	16
4.3 Quick Setup.....	17
4.4 Advanced Setup.....	17
4.4.1 Layer2 Interface	18
4.4.2 WAN Service.....	22
4.4.3 LAN	32
4.4.4 MAC Clone.....	34
4.4.5 NAT	35
4.4.6 Security	40
4.4.7 Parental Control	45
4.4.8 Quality of Service	48
4.4.9 Traffic Control.....	51
4.4.10 Routing.....	54
4.4.11 DNS.....	57
4.4.12 DSL	59

4.4.13 UPnP	60
4.4.14 Interface Grouping	61
4.4.15 LAN Ports.....	63
4.4.16 IPsec.....	63
4.5 Wireless	67
4.5.1 Basic	67
4.5.2 Security	68
4.5.3 MAC Filter	85
4.5.4 Wireless Bridge	86
4.5.5 Advanced	87
4.5.6 Station info	89
4.6 Diagnostics.....	89
4.7 Management	90
4.7.1 Settings	90
4.7.2 System Log	93
4.7.3 SNMP Agent	95
4.7.4 TR-069 client.....	96
4.7.5 Access Control	97
4.7.6 Update Firmware.....	98
4.7.7 Reboot.....	99
Appendix A: FAQ.....	100
Appendix B: Configuring the PC.....	103
Appendix C: Specifications	110
Appendix D: Glossary	111
Appendix E: Technical Support	115

Package Contents

The following contents should be found in your package:

- One TD-W8960N 300Mbps Wireless N ADSL2+ Modem Router
- One power Adapter for TD-W8960N 300Mbps Wireless N ADSL2+ Modem Router
- Quick Installation Guide
- One RJ45 cable
- Two RJ11 cables
- One ADSL splitter
- One Resource CD for TD-W8960N 300Mbps Wireless N ADSL2+ Modem Router, including:
 - This User Guide
 - Other Helpful Information

 **Note:**

Make sure that the package contains the above items. If any of the listed items are damaged or missing, please contact your distributor.

Chapter 1. Product Overview

Thank you for choosing the **TD-W8960N 300Mbps Wireless N ADSL2+ Modem Router**.

1.1 Overview of the Router

The TD-W8960N 300Mbps Wireless N ADSL2+ Modem Router integrates 4-port Switch, Firewall, NAT-Router and Wireless AP. Powered by 2x2 MIMO technology, the Wireless N Router delivers exceptional range and speed, which can fully meet the need of Small Office/Home Office (SOHO) networks and the users demanding higher networking performance.

The TD-W8960N 300Mbps Wireless N ADSL2+ Modem Router utilizes integrated ADSL2+ transceiver and high speed MIPS CPU. The Router supports full-rate ADSL2+ connectivity conforming to the ITU and ANSI specifications.

In addition to the basic DMT physical layer functions, the ADSL2+ PHY supports dual latency ADSL2+ framing (fast and interleaved) and the I.432 ATM Physical Layer.

Incredible Speed

The router provides up to 300Mbps wireless connection with other 802.11n wireless clients. The incredible speed makes it ideal for handling multiple data streams at the same time, which ensures your network stable and smooth. The performance of this 802.11n wireless Router will give you the unexpected networking experience at speed 650% faster than 802.11g. It is also compatible with all IEEE 802.11g and IEEE 802.11b products.

Multiple Security Protections

With multiple protection measures, including SSID broadcast control and wireless LAN 64/128 WEP encryption, Wi-Fi protected Access (WPA2-PSK, WPA-PSK), as well as advanced Firewall protections, the TD-W8960N 300Mbps Wireless N ADSL2+ Modem Router provides complete data privacy.

Flexible Access Control

The Router provides flexible access control, so that parents or network administrators can establish restricted access policies for children or staff. It also supports Virtual Server and DMZ host for Port Triggering, and then the network administrators can manage and monitor the network in real time with the remote management function.

Simple Installation

Since the Router is compatible with virtually all the major operating systems, it is very easy to manage. Quick Setup Wizard is supported and detailed instructions are provided step by step in this user guide. Before installing the Router, please look through this guide to know all the Router's functions.

1.2 Main Features

- Complies with IEEE 802.11n to provide a wireless data rate of up to 300Mbps
- One RJ11 LINE port, four 10/100M Auto-Negotiation RJ45 LAN ports, supporting Auto MDI/MDIX
- Quick response semi-conductive surge protect circuit, reliable surge-protect function
- AFE to support Annex A and L deployments
- Provides external splitter
- Multi-user sharing a high-speed Internet connection
- Connecting the internet on demand and disconnecting from the Internet when idle for PPPoE
- Provides WPA/WPA2, WPA-PSK/WPA2-PSK data security, TKIP/AES encryption security
- Provides 64/128-bit WEP encryption security and wireless LAN ACL (Access Control List)
- Adopts Advanced DMT modulation and demodulation technology
- Adopts 300M wireless LAN transmission technology
- Supports access control, parents and network administrators can establish restricted access policies based on time of day for children or staff
- Supports Virtual Server, Port Triggering and DMZ host
- Supports UPnP, Dynamic DNS, Static Routing
- Supports bridge mode and Router function
- Supports Web management
- Supports firmware upgrade
- Supports Flow Statistics
- Supports QSS (Quick Secure Setup)
- Built-in firewall supporting IP address filtering, MAC address filtering and parental control
- Built-in DHCP server

1.3 Panel Layout

1.3.1 The Front Panel

The Router's LEDs are located on the front panel.

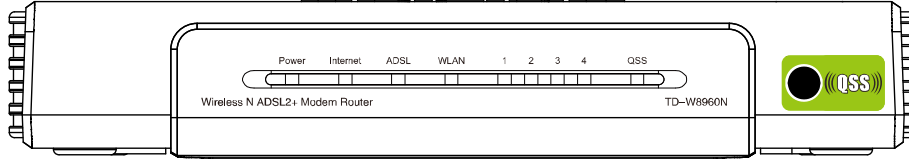

Figure 1-1

The Router's LEDs and the QSS button are located on the front panel (View from left to right).

LED Explanation:

Name	Status	Indication
Power	On	The modem router is powered on.
	Off	The modem router is off. Please ensure that the power adapter is connected correctly.
Internet	On	The network is available with a successful Internet connection.
	Flash	There is data being transmitted or received via the Internet.
	Off	There is no successful Internet connection or the modem router is operating in Bridge mode. Please refer to Note 2 for troubleshooting.
ADSL	On	ADSL line is synchronized and ready to use.
	Flash	The ADSL negotiation is in progress.
	Off	ADSL synchronization fails. Please refer to Note 1 for troubleshooting.
WLAN	On	Wireless is enabled but no data is being transmitted.
	Flash	The modem router is sending or receiving data over the wireless network.
	Off	Wireless function is disabled.
LAN 1,2,3,4	On	There is a device connected to this LAN port.
	Flash	The modem router is sending or receiving data over this LAN port.
	Off	There is no device connected to this LAN port.
QSS	On	A wireless device has been successfully added to the network by QSS function.
	Flash	QSS handshaking is in process and will continue for about 2 minutes. Please press the QSS button on other wireless devices that you want to add to the network while the LED is flashing.
	Off	The QSS function is disabled or the wireless device fails to be added to the network in 2 minutes after QSS function is enabled. Please refer to 4.5.2.1 QSS (WPS) Setup for more information.

 **Note:**

1. If the ADSL LED is off, please check your Internet connection first. Refer to [2.3 Connecting the Router](#) for more information about how to make Internet connection correctly. If you have already made a right connection, please contact your ISP to make sure if your Internet service is available now.
2. If the Internet LED is off, please check your ADSL LED first. If your ADSL LED is also off, please refer to [Note 1](#). If your ADSL LED is GREEN ON, please check your Internet configuration. You may need to check this part of information with your ISP and make sure everything have been input correctly. Refer to [4.2 Device Info](#) for more information.

1.3.2 The Back Panel

The Router's ports, where the cables are connected, and RESET button are located on the back panel.

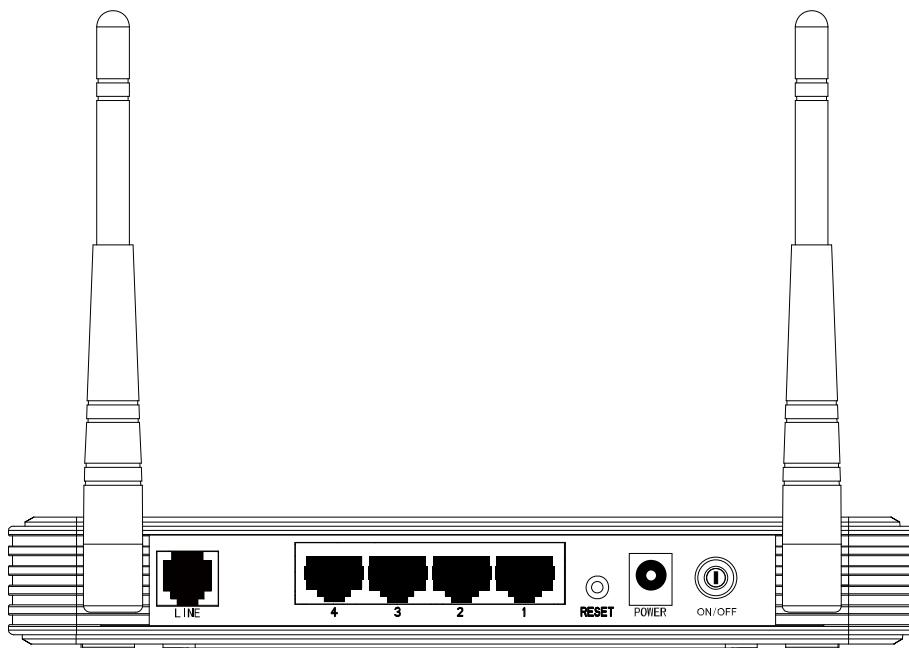

Figure 1-2

- **LINE:** Connect to the Modem Port of Splitter or to the telephone line.
- **1, 2, 3, 4 (LAN):** The ports (1, 2, 3, 4) connect the Router to the local PC(s).
- **RESET:** There are two ways to reset the Router's factory defaults.
 - 1) Use the **Restore Default** function on **Management** -> **settings** -> **Restore Default** page in the router's Web-based Utility.
 - 2) Use the Factory Default **RESET** button: With the Router powered on, use a pin to press and hold the **RESET** button for at least 5 seconds. And the Router will reboot to its factory default settings.
- **POWER:** The Power plug is where you will connect the power adapter.
- **ON/OFF:** The switch for the power.
- **Wireless Antennas:** To receive and transmit the wireless data.

Chapter 2. Connecting the Router

2.1 System Requirements

- Broadband Internet Access Service (DSL/Cable/Ethernet).
- PCs with a working Ethernet Adapter and an Ethernet cable with RJ45 connectors.
- TCP/IP protocol on each PC.
- Web browser, such as Microsoft Internet Explorer, Mozilla Firefox or Apple Safari.

2.2 Installation Environment Requirements

- Place the Router in a well ventilated place far from any heater or heating vent
- Avoid direct irradiation of any strong light (such as sunlight)
- Keep at least 2 inches (5 cm) of clear space around the Router
- Operating temperature: 0°C~40°C (32°F~104°F)
- Operating Humidity: 10% ~ 90% RH (non-condensing)

2.3 Connecting the Router

[Back to LED Explanation](#)

Before installing the Router, please make sure your broadband service provided by your ISP is available. If there is any problem, please contact your ISP. After that, please install the Router according to the following steps. Don't forget to pull out the power plug and keep your hands dry.

1. Locate an optimum location for the Router. The best place is usually at the center of your wireless network.
2. Adjust the direction of the antenna. Normally, upright is a good direction.
3. Connect your PC and Switch/Hub in your LAN to the LAN Ports of the Router. (If you have a wireless NIC and want to have wireless connection, please skip this step.)
4. Connect the telephone line to the Line port on the Router. Or you can access the Internet and make calls at the same time by using a separate splitter to divide the data and voice. The external splitter has three ports:
 - LINE: Connect to the wall jack
 - PHONE: Connect to the phone sets
 - MODEM: Connect to the ADSL LINE port of device

Plug one end of the twisted-pair ADSL cable into the ADSL LINE port on the rear panel of device. Connect the other end to the MODEM port of the external splitter.

5. Connect the power adapter to the power plug of the Router, and the other end into an electrical outlet. The electrical outlet shall be installed near the device and shall be easily accessible.
6. Turn on the ON/OFF switch to power the device. It will start to work automatically.

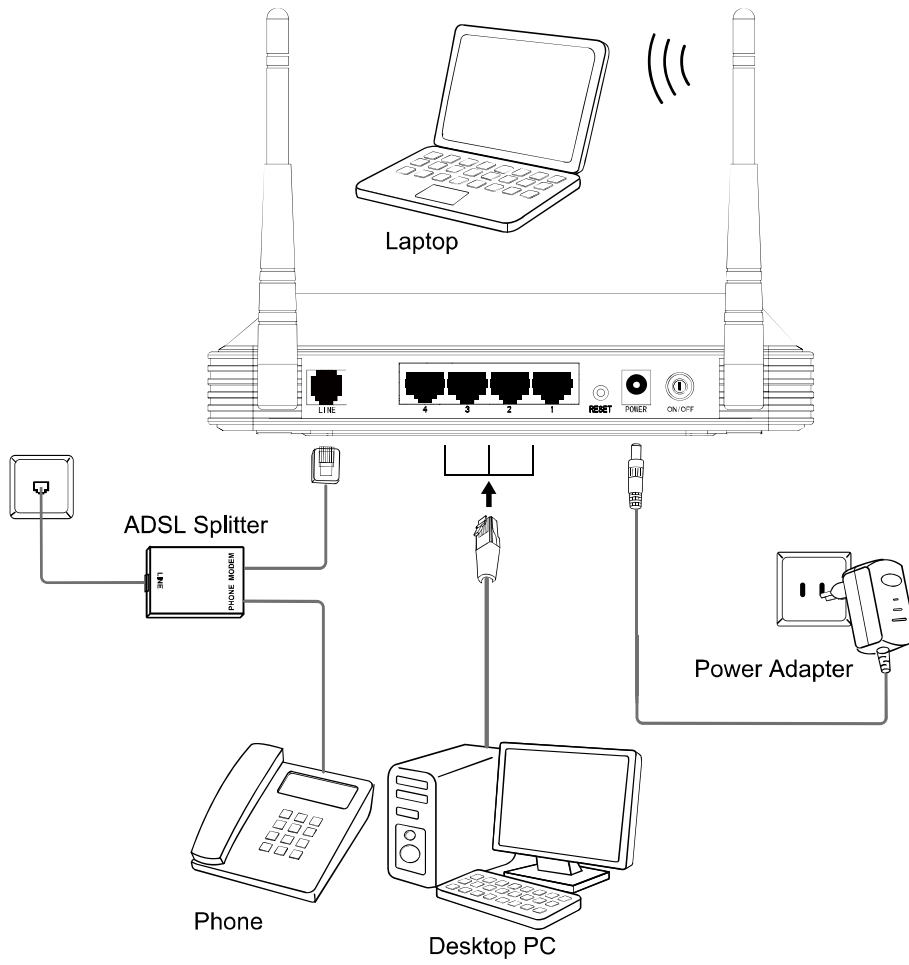

Figure 2-1

Chapter 3. Quick Installation Guide

This chapter will show you how to configure the basic functions of your **TD-W8960N 300Mbps Wireless N ADSL2+ Modem Router** using **Quick Setup Wizard** within minutes.

3.1 Configuring the PC

After you directly connect your PC to the **TD-W8960N** or connect your adapter to a Hub/Switch which has connected to the Router, you need to configure your PC's IP address. Follow the steps below to configure it. Here takes Windows XP for example. For more details, please refer to [Appendix B](#).

Step 1: Click the **Start** menu on your desktop, right click **My Network Places**, and then select **Properties** (shown in Figure 3-1).

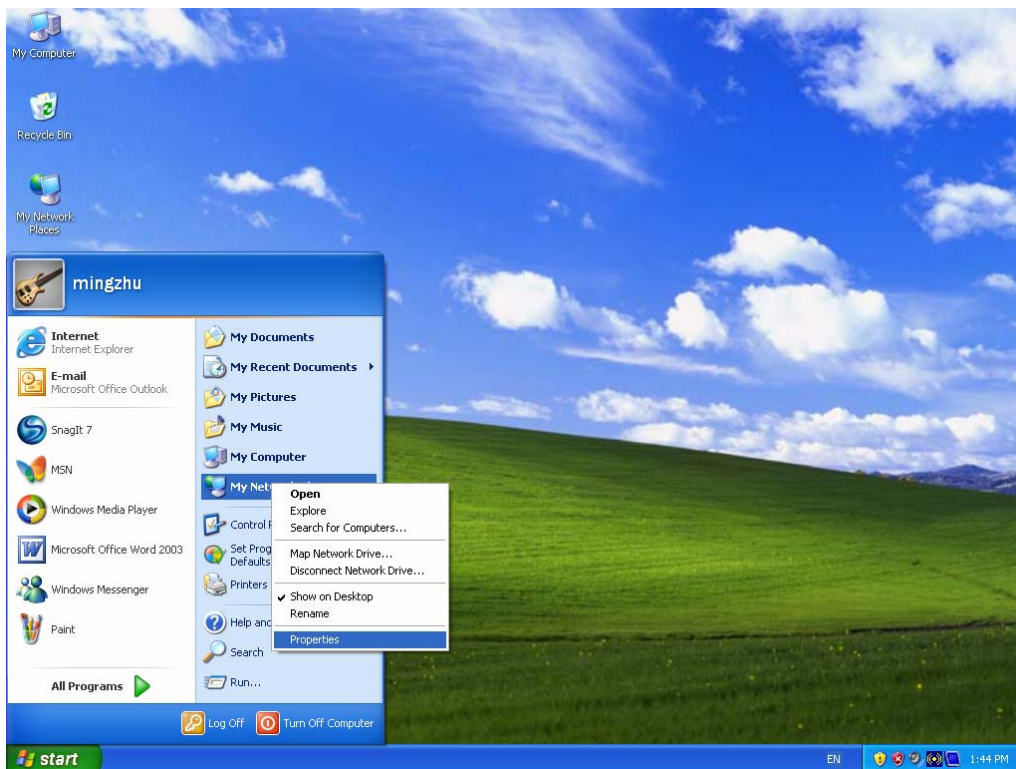

Figure 3-1

Step 2: Right click **Local Area Connection (LAN)**, and then select **Properties**.

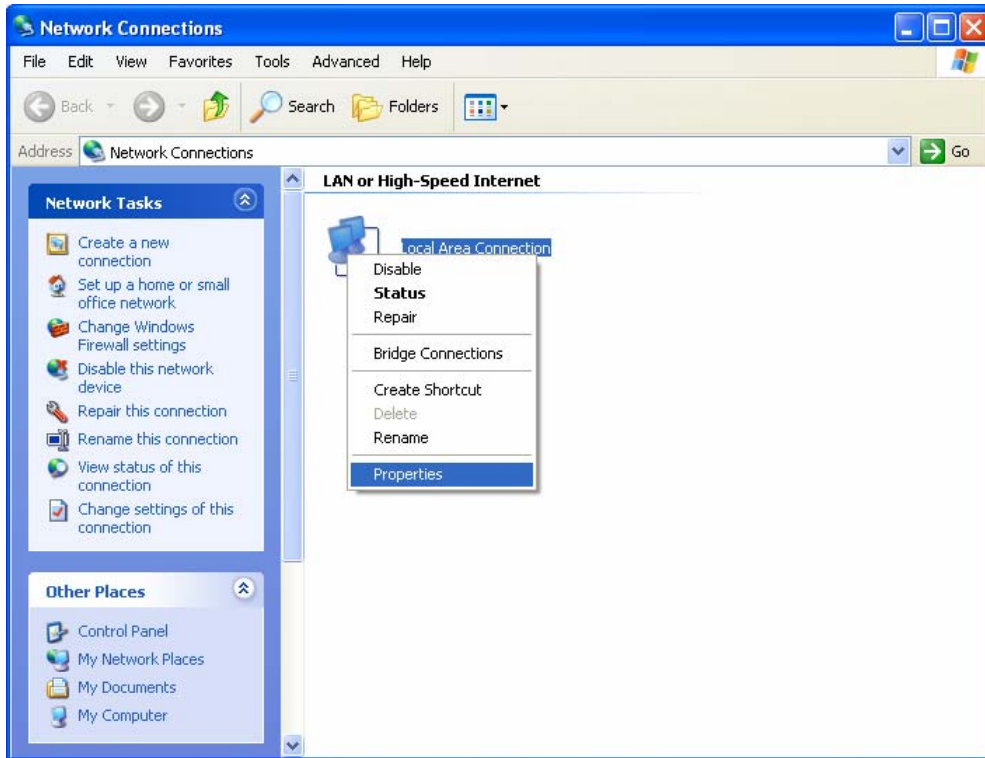

Figure 3-2

Step 3: Select **General** tab, highlight **Internet Protocol (TCP/IP)**, and then click the **Properties** button.

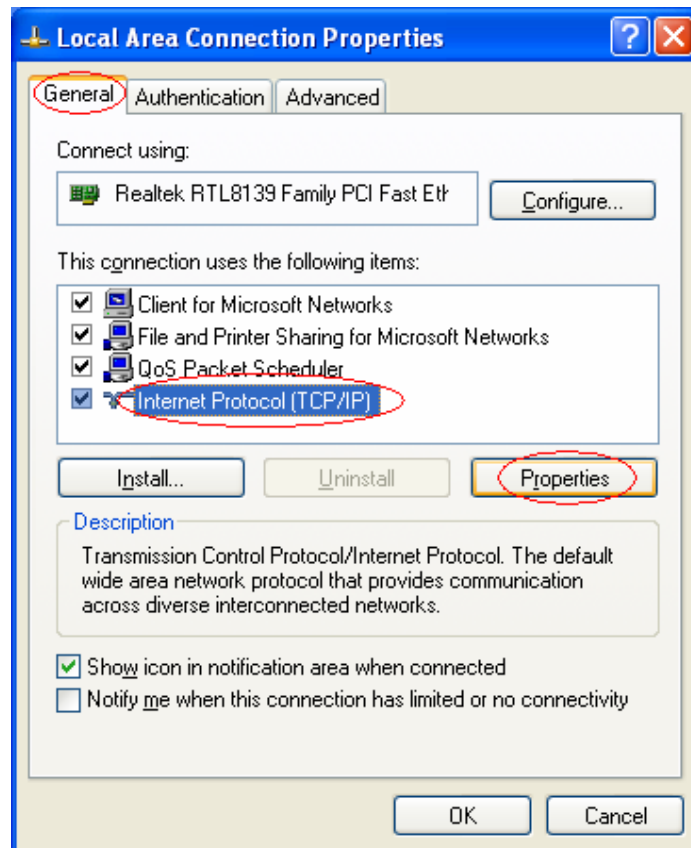

Figure 3-3

Step 4: Configure the IP address as Figure 3-4 shows. After that, click **OK**.

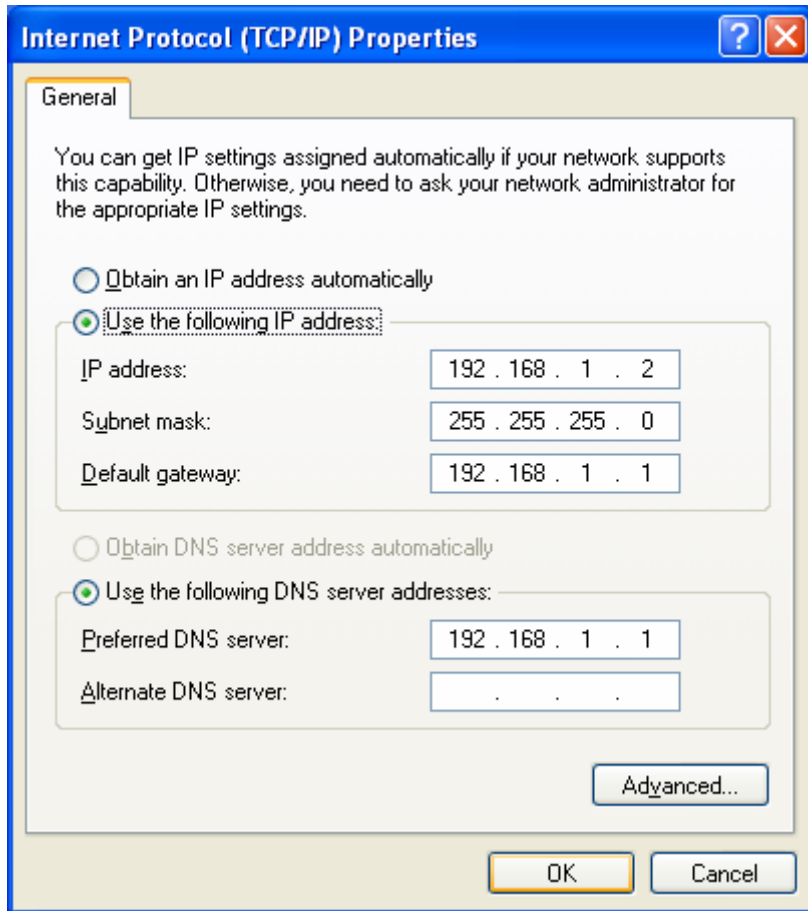

Figure 3-4

Note:

You can configure the PC to get an IP address automatically, select “Obtain an IP address automatically” and “Obtain DNS server address automatically” in the screen above.

Now, you can run the Ping command in the command prompt to verify the network connection. Please click the **Start** menu on your desktop, select **run** tab, type **cmd** or **command** in the field and press **Enter**. Type **ping 192.168.1.1** on the next screen, and then press **Enter**.

If the result displayed is similar to the screen below, the connection between your PC and the Router has been established.

```
Pinging 192.168.1.1 with 32 bytes of data:
Reply from 192.168.1.1: bytes=32 time<1ms TTL=64
Reply from 192.168.1.1: bytes=32 time<1ms TTL=64
Reply from 192.168.1.1: bytes=32 time<1ms TTL=64
Reply from 192.168.1.1: bytes=32 time<1ms TTL=64

Ping statistics for 192.168.1.1:
    Packets: Sent = 4, Received = 4, Lost = 0 (0% loss),
Approximate round trip times in milli-seconds:
    Minimum = 0ms, Maximum = 0ms, Average = 0ms
```

Figure 3-5

If the result displayed is similar to the screen shown below, it means that your PC has not connected to the Router.

```
Pinging 192.168.1.1 with 32 bytes of data:
Request timed out.
Request timed out.
Request timed out.
Request timed out.

Ping statistics for 192.168.1.1:
    Packets: Sent = 4, Received = 0, Lost = 4 (100% loss),
```

Figure 3-6

You can check it following the steps below:

1) Is the connection between your PC and the Router correct?

The LEDs of LAN port which you link to the device and the LEDs on your PC's adapter should be lit.

2) Is the TCP/IP configuration for your PC correct?

If the Router's IP address is 192.168.1.1, your PC's IP address must be within the range of 192.168.1.2 ~ 192.168.1.254.

3.2 Quick Installation Guide

With a Web-based utility, it is easy to configure and manage the TD-W8960N 300Mbps Wireless N ADSL2+ Modem Router. The Web-based utility can be used on any Windows, Macintosh or UNIX OS with a Web browser, such as Microsoft Internet Explorer, Mozilla Firefox or Apple Safari.

1. To access the configuration utility, open a web-browser and type the default address `http://192.168.1.1` in the address field of the browser.



Figure 3-7

After a moment, a login window will appear, similar to the Figure 3-8. Enter **admin** for the User Name and Password, both in lower case letters. Then click the **OK** button or press the **Enter** key.



Figure 3-8

Note:

- 1) Do not mix up the user name and password with your ADSL account user name and password which are needed for PPP connections.
 - 2) If the above screen does not pop up, it means that your Web-browser has been set to a proxy. Go to **Tools** menu→**Internet Options**→**Connections**→**LAN Settings**, in the screen that appears, cancel the Using Proxy checkbox, and click **OK** to finish it.
2. After your successful login, you will see the Login screen as shown in Figure 3-9. Click **Quick Setup** menu to access **Quick Setup Wizard**.

Device Info	<h2 style="margin: 0;">Device Info</h2> <hr/> <table border="1" style="width: 100%; border-collapse: collapse;"> <tr> <td style="width: 30%;">Firmware Version:</td> <td>1.4.0 Build 110422 Rel.61740n</td> </tr> <tr> <td>Hardware Version:</td> <td>TD-W8960N v3 0x00000002</td> </tr> </table> <p style="font-size: small; margin-top: 5px;">This information reflects the current status of your DSL connection.</p> <table border="1" style="width: 100%; border-collapse: collapse;"> <tr> <td style="width: 50%;">Line Rate - Upstream (Kbps):</td> <td></td> </tr> <tr> <td>Line Rate - Downstream (Kbps):</td> <td></td> </tr> <tr> <td>LAN IP Address:</td> <td>192.168.1.1</td> </tr> <tr> <td>Default Gateway:</td> <td>0.0.0.0 ()</td> </tr> <tr> <td>Primary DNS Server:</td> <td></td> </tr> <tr> <td>Secondary DNS Server:</td> <td></td> </tr> <tr> <td>System Running time:</td> <td>0 day(s) 00:02:00</td> </tr> </table> <hr/>	Firmware Version:	1.4.0 Build 110422 Rel.61740n	Hardware Version:	TD-W8960N v3 0x00000002	Line Rate - Upstream (Kbps):		Line Rate - Downstream (Kbps):		LAN IP Address:	192.168.1.1	Default Gateway:	0.0.0.0 ()	Primary DNS Server:		Secondary DNS Server:		System Running time:	0 day(s) 00:02:00
Firmware Version:		1.4.0 Build 110422 Rel.61740n																	
Hardware Version:		TD-W8960N v3 0x00000002																	
Line Rate - Upstream (Kbps):																			
Line Rate - Downstream (Kbps):																			
LAN IP Address:		192.168.1.1																	
Default Gateway:		0.0.0.0 ()																	
Primary DNS Server:																			
Secondary DNS Server:																			
System Running time:		0 day(s) 00:02:00																	
Quick Setup																			
Advanced Setup																			
Wireless																			
Diagnostics																			
Management																			

Figure 3-9

3. Change the VPI or VCI values which are used to define a unique path for your connection. **If you have been given specific settings for this to configuration, type in the correct**

values assigned by your ISP. Here we select PPPoE WAN Link Type for example, enter the **Username** and **Password** given by your ISP, and then click **Next**.

Quick Setup - WAN Configurations

You can configure an ATM PVC identifier (VPI and VCI), select your WAN Link Type.

VPI: [0-255]

VCI: [32-65535]

WAN Link Type:

Encapsulation Mode: (optional)

PPP Username:

PPP Password:

PPPoE Service Name: (optional)

MTU Size

Dial on demand (with idle timeout timer)

Use Static IPv4 Address (optional)

DNS Settings: Obtain Automatically Set DNS Manually

Primary DNS:

Secondary DNS: (optional)

Figure 3-10

Note:

The Quick Setup Wizard will guide you to configure the WAN Service over ATM interface.

- On the **Wireless Configurations** screen, we use the default SSID, select Network Authentication (take **Mixed WPA2/WPA-PSK Personal** for example), set a Pre-Shared Key, and then click **Save** to continue.

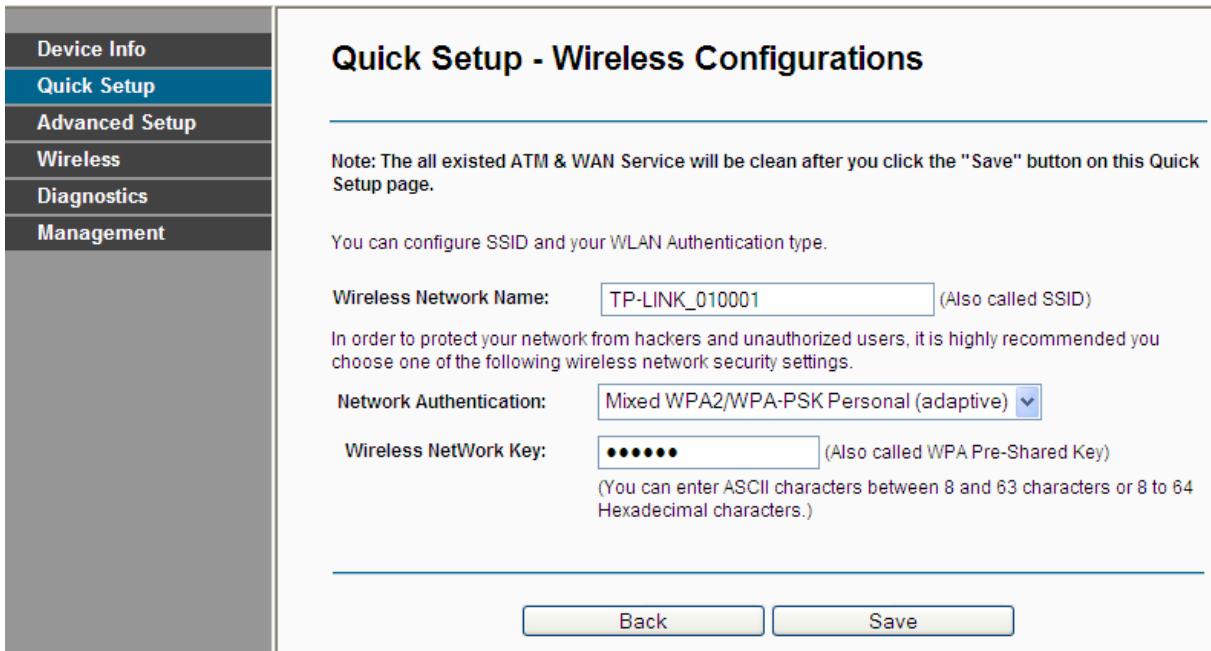

Figure 3-11

Note:

All the existed **ATM&WAN** service will be cleared after clicking the **Save** button on this Quick Setup page.

- You will see the **Finish** screen below, click **Reboot** to save these settings.

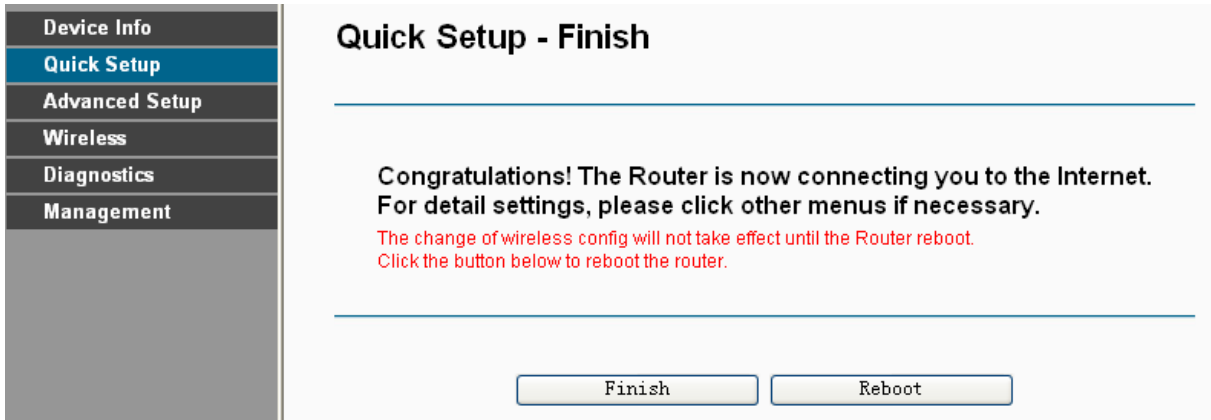

Figure 3-12

- Now, your ADSL Modem Router has been configured and is rebooting. Please do not power off the Router while it's rebooting.

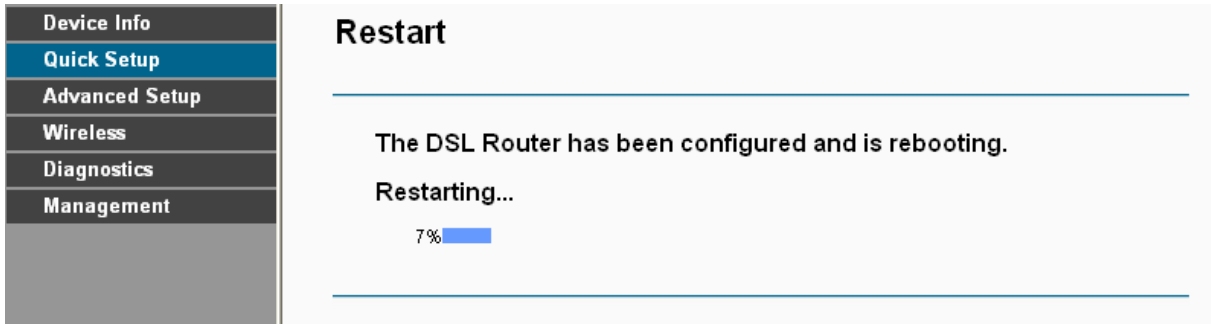

Figure 3-13

- You will see the current configuration has been added to Layer2 Interface list ([4.4.1 Layer2 Interface](#)) shown in Figure 3-14 and WAN Service list ([4.4.2 WAN Service](#)) shown in Figure 3-15.

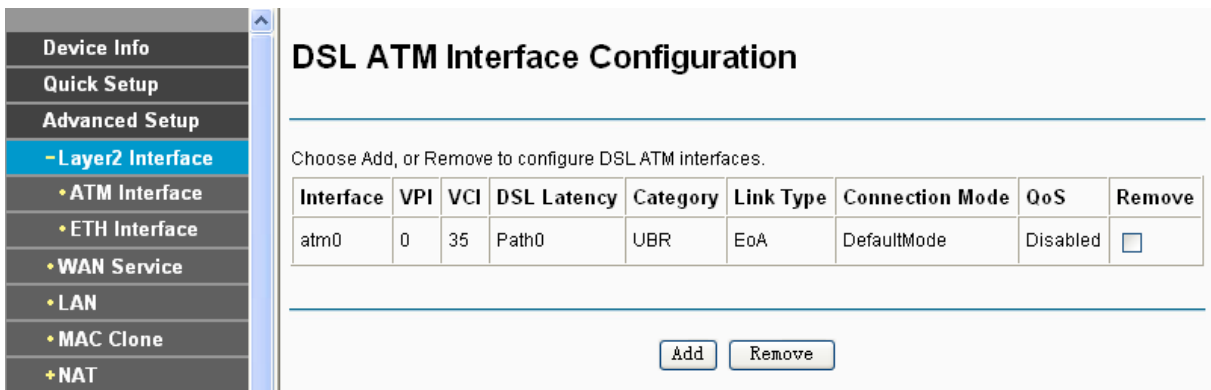

Figure 3-14

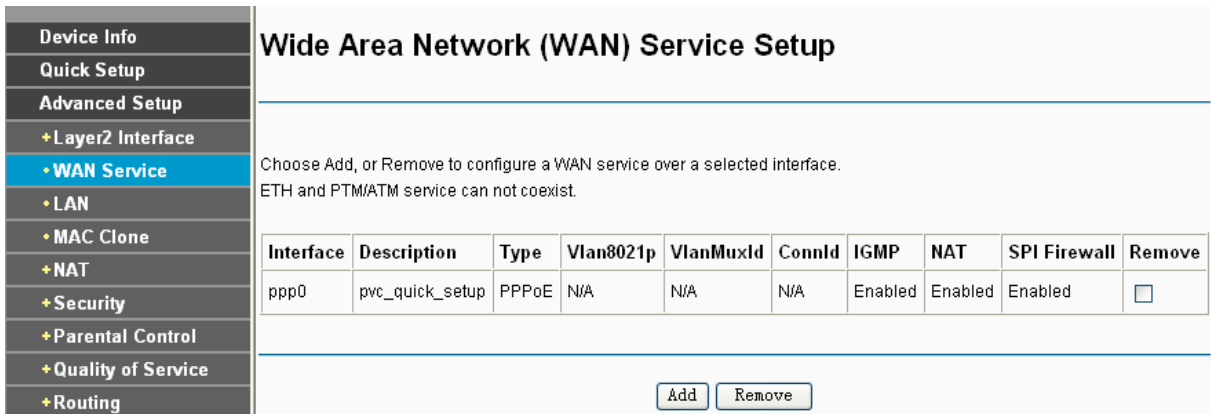

Figure 3-15

Note:

More detailed configurations please refer to [4.4.1 Layer2 Interface](#) and [4.4.2 WAN Service](#).

Chapter 4. Configuring the Router

This chapter will show each Web page's key function and the configuration way.

4.1 Login

After your successful login, you will see the six main menus on the left of the Web-based utility. On the right, there are the corresponding explanations and instructions.



Device Info
Quick Setup
Advanced Setup
Wireless
Diagnostics
Management

The detailed explanations for each Web page's key function are listed below.

4.2 Device Info

Choose “**Device Info**” menu, there are six submenus under the main menu: **Summary**, **WAN**, **Statistics**, **Route**, **ARP** and **DHCP**. This Device Info section mainly introduces the elementary information about the Router and its current settings in use. Click any of them, and you will be able to view the corresponding information.

Choose “**Device Info**” → “**Summary**”, you will see the Summary screen (shown in Figure 4-1). The first table indicates the information about the version including Software and Hardware. The second table displays the current status of the TD-W8960N connection. This information will vary depending on the settings of the Router configured on the Advanced Setup screen.

Device Info	<h2>Device Info</h2> <hr/> <table border="1"> <tr> <td>Firmware Version:</td> <td>1.4.0 Build 110422 Rel.61740n</td> </tr> <tr> <td>Hardware Version:</td> <td>TD-W8960N v3 0x00000002</td> </tr> </table> <p>This information reflects the current status of your DSL connection.</p> <table border="1"> <tr> <td>Line Rate - Upstream (Kbps):</td> <td></td> </tr> <tr> <td>Line Rate - Downstream (Kbps):</td> <td></td> </tr> <tr> <td>LAN IP Address:</td> <td>192.168.1.1</td> </tr> <tr> <td>Default Gateway:</td> <td>0.0.0.0 ()</td> </tr> <tr> <td>Primary DNS Server:</td> <td></td> </tr> <tr> <td>Secondary DNS Server:</td> <td></td> </tr> <tr> <td>System Running time:</td> <td>0 day(s) 00:02:00</td> </tr> </table> <hr/>	Firmware Version:	1.4.0 Build 110422 Rel.61740n	Hardware Version:	TD-W8960N v3 0x00000002	Line Rate - Upstream (Kbps):		Line Rate - Downstream (Kbps):		LAN IP Address:	192.168.1.1	Default Gateway:	0.0.0.0 ()	Primary DNS Server:		Secondary DNS Server:		System Running time:	0 day(s) 00:02:00
Firmware Version:		1.4.0 Build 110422 Rel.61740n																	
Hardware Version:		TD-W8960N v3 0x00000002																	
Line Rate - Upstream (Kbps):																			
Line Rate - Downstream (Kbps):																			
LAN IP Address:		192.168.1.1																	
Default Gateway:		0.0.0.0 ()																	
Primary DNS Server:																			
Secondary DNS Server:																			
System Running time:	0 day(s) 00:02:00																		
Quick Setup																			
Advanced Setup																			
Wireless																			
Diagnostics																			
Management																			

Figure 4-1

 **Note:**

Click the other submenus under the main menu **Device Info**, and you will be able to view the corresponding information about **WAN**, **Statistics**, **Route**, **ARP** and **DHCP**.

4.3 Quick Setup

Please refer to Section [3.2 Quick Installation Guide](#).

4.4 Advanced Setup

Choose “**Advanced Setup**”, there are many submenus under the main menu. Among the submenus, **Layer2 Interface**, **WAN Service**, **LAN** etc. are default menus, while **NAT**, **IP/MAC filtering** of the **Security**, **Quality of Service** and **DNS** will appear only when you select some corresponding functions. Click any one of them, and you will be able to configure the corresponding function.

Advanced Setup
+Layer2 Interface
•WAN Service
•LAN
•MAC Clone
+NAT
+ Security
+Parental Control
+Quality of Service
+Traffic Control
+Routing
+DNS
•DSL
•UPnP
•Interface Grouping
•LAN Ports
•IPSec

This Advanced Setup section mainly introduces how to configure the Router for adequate use. The detailed explanations for each subsection are provided below.

 **Note:**

To completely configure the WAN Interface, you need to first select the Layer2 Interface ([4.4.1 Layer2 Interface](#)) according to the connection ISP provides you, and then to select the type of the connection ([4.4.2 WAN Service](#)) for the further configuration.

4.4.1 Layer2 Interface

Choose “**Advanced Setup**”→“**Layer2 Interface**”, and you can select WAN Service Interface (layer2 interface) over **ATM interfaces** or **ETH interface**.

- **ATM Interface:** Configure the Router to access Internet as an ADSL user. ISP provides you VPI (Virtual Path Identifier), VCI (Virtual Channel Identifier) settings and the DSL Interface with RJ11 connector. (Figure 2-1)
- **ETH Interface:** Configure the Router to access Internet as an Ethernet user. ISP provides you Broadband Internet Service and the Ethernet Interface with RJ45 connector.

4.4.1.1 ATM interface

Choose “**Advanced Setup**”→“**Layer2 Interface**→**ATM interface**”, you can Configure ATM interfaces on the screen below.

- Device Info
- Quick Setup
- Advanced Setup
- Layer2 Interface
- ATM Interface
- ETH Interface
- WAN Service
- LAN
- MAC Clone
- Security
- Parental Control
- Quality of Service
- Traffic Control
- Routing
- DNS
- DSL
- UPnP
- Interface Grouping

DSL ATM Interface Configuration

Choose Add, or Remove to configure DSL ATM interfaces.

Interface	VPI	VCI	DSL Latency	Category	Link Type	Connection Mode	QoS	Remove
atm0	0	32	Path0	UBR	EoA	DefaultMode	Disabled	<input type="checkbox"/>
atm1	1	33	Path0	UBR	EoA	DefaultMode	Disabled	<input type="checkbox"/>
atm2	0	35	Path0	UBR	EoA	DefaultMode	Disabled	<input type="checkbox"/>
atm3	0	100	Path0	UBR	EoA	DefaultMode	Disabled	<input type="checkbox"/>
atm4	8	35	Path0	UBR	EoA	DefaultMode	Disabled	<input type="checkbox"/>
atm5	8	81	Path0	UBR	EoA	DefaultMode	Disabled	<input type="checkbox"/>
atm6	0	200	Path0	UBR	EoA	DefaultMode	Disabled	<input type="checkbox"/>

Figure 4-2

- **Remove:** Select the check box in the table on the screen above and then click the **Remove** button, the corresponding interface will be deleted in the table.

Note:

If the interface is used by the configuration of the [4.4.2 WAN Service](#), you need to remove the corresponding WAN Service entry first before you can remove it here.

- **Add:** Click the button, and you can add a new interface in the next screen.

Device Info
Quick Setup
Advanced Setup
- Layer2 Interface
• ATM Interface
• ETH Interface
• WAN Service
• LAN
• MAC Clone
+ Security
+ Parental Control
+ Quality of Service
+ Traffic Control
+ Routing
+ DNS
• DSL
• UPnP
• Interface Grouping
• LAN Ports
• IPSec
Wireless
Diagnostics
Management

ATM PVC Configuration

This screen allows you to configure an ATM PVC identifier (VPI and VCI), select DSL latency, select a service category. Otherwise choose an existing interface by selecting the checkbox to enable it.

VPI: [0-255]

VCI: [32-65535]

Select DSL Link Type (EoA is for PPPoE, IPoE, and Bridge.)

EoA
 PPPoA
 IPoA

Encapsulation Mode:

Service Category:

Select Connection Mode

Default Mode - Single service over one connection
 VLAN MUX Mode - Multiple Vlan service over one connection
 MSC Mode - Multiple Service over one Connection

Enable Quality Of Service

Enabling packet level QoS for a PVC improves performance for selected classes of applications. QoS cannot be set for CBR and Realtime VBR. QoS consumes system resources; therefore the number of PVCs will be reduced. Use **Advanced Setup/Quality of Service** to assign priorities for the applications.

Enable Quality Of Service.

Figure 4-3

- **VPI/VCI:** the VPI and VCI values provided by your ISP. Do not change them unless it was required by your ISP.
- **DSL Link Type:** Select a DSL Link Type which is provided by your ISP. The options include **EoA** (it is for PPPoE, IPoE, and Bridge), **PPPoA** (PPP over ATM) and **IPoA** (IP over ATM).
- **Encapsulation Mode:** The mode of the data processing over the Link Type you have selected. Uses the default setting, if you are not sure.
- **Service Category:** Select the type of the service assigned by your ISP in the drop-down list. The default type is **UBR Without PCR**.
- **Connection Mode:** Select the connection mode for **EoA** option of DSL Link Type. The options include Default mode for single service over one connection, VLAN MUX Mode for multiple Vlan service over one connection, and MSC Mode for Multiple Service over one connection.
- **Enable Quality of Service:** If you want to adopt **QoS** (Quality of Service) for the connection, please select check box.

Note:

Enabling packet level QoS for PVC improves performance for selected classes of applications. While QoS consumes system resources; therefore the number of PVC(s) will be reduced. Besides

this, it cannot be set for the connection type of CBR and Real-time VBR. If you select the QoS service, the Quality of Service menu will be added to the Web-based Utility, the detailed configuration will be described in **4.4.8 Quality of Service**.

4.4.1.2 ETH interface

Choose “**Advanced Setup**”→“**Layer2 Interface**→**ETH Interface**”, you can configure ETH WAN interfaces on the screen below.

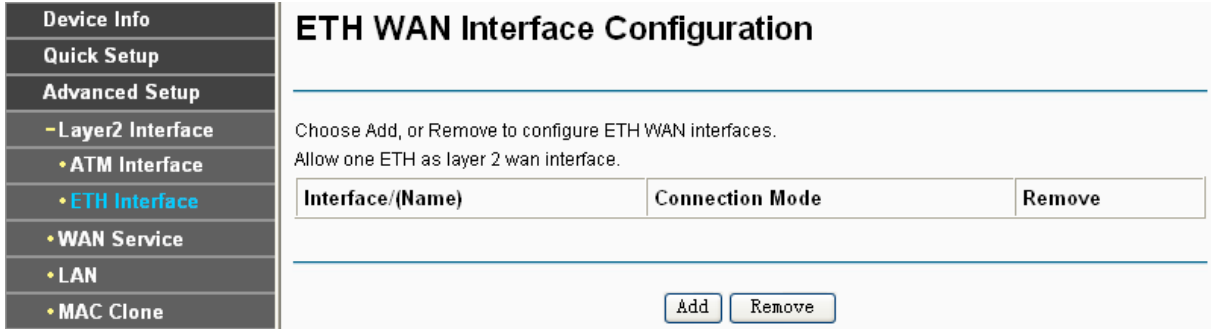

Figure 4-4

Note:

To make sure the ETH port available, you should first choose “**Advanced Setup**”→“**LAN Ports**” to enable the Virtual LAN Ports feature.

- **Add:** Click the **Add** button, and you can add a new interface in the next screen.

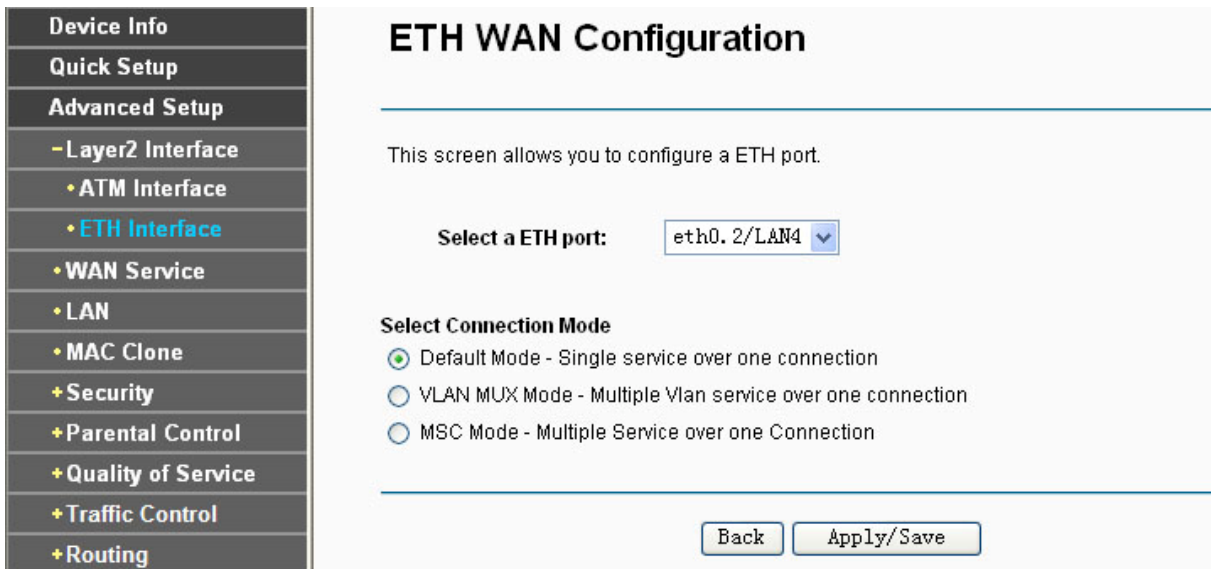

Figure 4-5

- **ETH port:** Select an ETH port to configure as the WAN port.
- **Select Connection Mode:** Choose a connection mode for the port.

Click **Apply/Save** to save your settings and then you will see the screen similar to Figure 4-6.

Figure 4-6

- **Remove:** Select the check box in the table on the screen above and then click the **Remove** button, the corresponding interface will be deleted in the table.

Note:

One ETH is allowed to configure as the layer 2 WAN Interface.

4.4.2 WAN Service

Choose “**Advanced Setup**”→“**WAN Service**”, and you will see the WAN Port Information Table in the screen similar to Figure 4-7, which describes the WAN port settings and the relevant manipulation to each interface. After you add a new Lay2 Interface, please follow the instructions below to complete the further configuration of WAN Interface. There are five different configurations for the connection types, which are PPPoE, IPoE, Bridge, PPPoA, and IPoA. You can select the corresponding types according to your needs.

Figure 4-7

Note:

- 1) The following section adopts different VPI, VCI to introduce further configuration for the different connection types, if you need to change the configuration of ATM PVC (VPI/VCI), you should go to the previous section ([4.4.1 Layer2 Interface](#)) to configure them again.
- 2) ETH and ATM service can not coexist. If the ETH Interface had configured, you cannot configure any other WAN service over the ATM Interface until the ETH Interface is deleted.

4.4.2.1 ATM-EoA-PPPoE

If your ISP provides a **PPPoE** connection and you need to use an ATM Interface, follow the steps below to add a WAN service over a selected ATM interface:

1. Add a **new** ATM interface and select **EoA** option for DSL Link Type ([4.4.1.1 ATM interface](#)).
2. Click the **Add** button on the screen Figure 4-7 and you will enter the next screen as shown in Figure 4-8. Click **Next**.

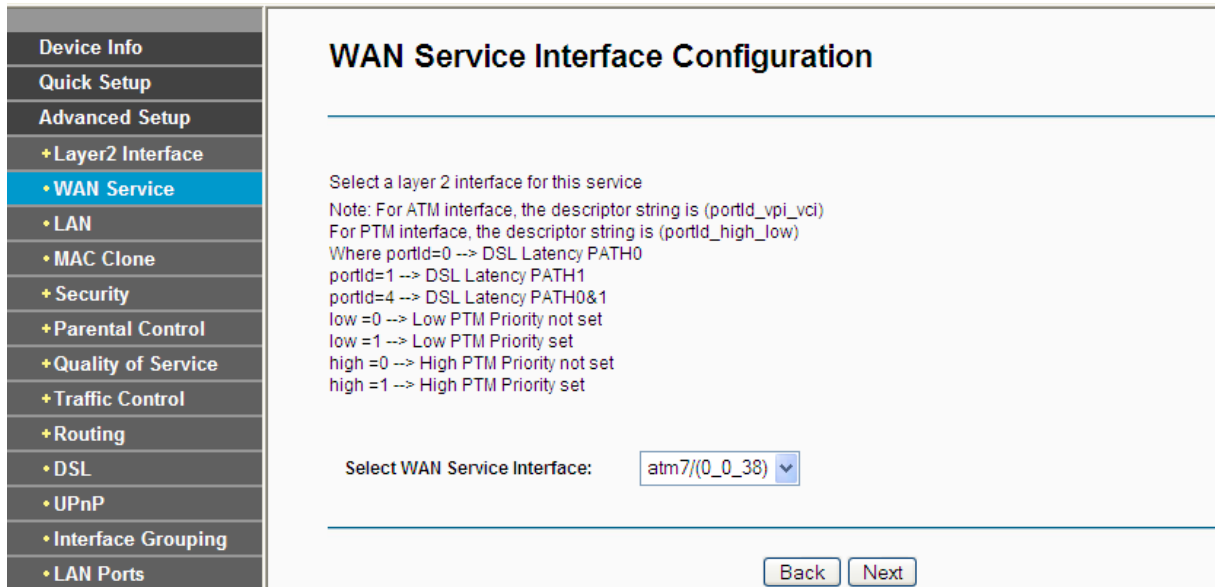

Figure 4-8

3. Select the **WAN service type** in Figure 4-9. If your ISP provides a PPPoE connection, select **PPPoE** option. You can create a service name for the **Service Description** or leave it the default name. Click **Next**.

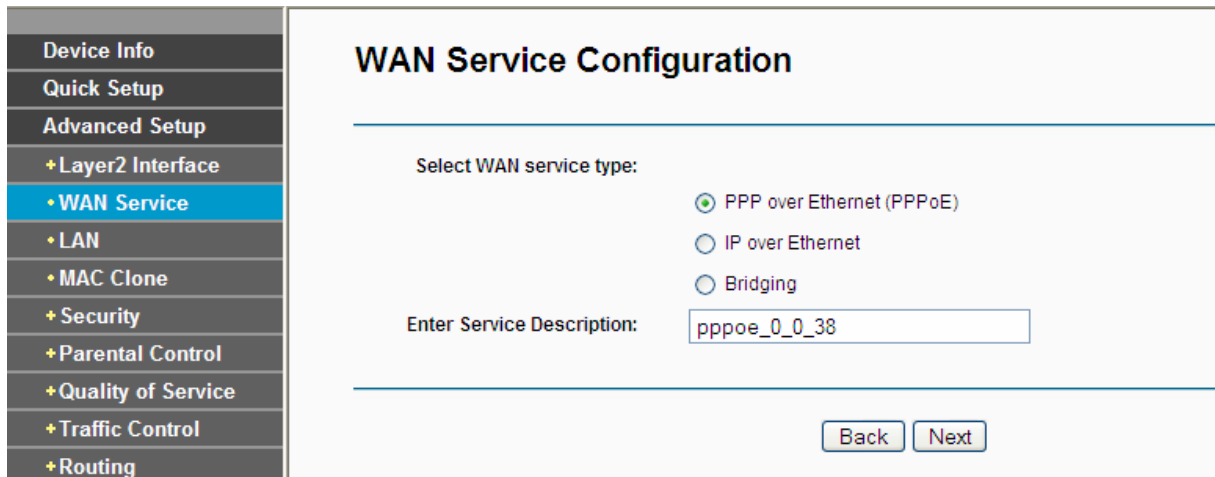

Figure 4-9

4. Enter the following parameters and then click **Next**.

Figure 4-10

- **PPP Username/Password:** Enter the User Name and Password provided by your ISP. These fields are case-sensitive.
- **PPPoE Service Name:** Enter the Service Name if it was provided by your ISP. If you leave it blank, the default name will be the same as the **Service Description** on the previous screen.
- **Authentication Method:** Select the **Authentication Method** from the drop-down list, the default method is **AUTO**, and you can leave it as a default setting.

Note:

If you are not sure about the **PPP IP extension** and **PPP Debug Mode** etc. below, please don't select these options.

- **MTU Size:** Maximum Transmission Unit Size. Check this box then you can change the MTU size. The default **MTU** value is 1480 Bytes. It is not recommended that you change the default value unless required by your ISP.
- **Enable Fullcone NAT:** It is a type of NAT, if not enabled, the default NAT will act.
- **Dial on demand (with idle timeout timer):** The Router will cut off the Internet connection after it has been inactive for a specific period of time (idle timeout), and it will automatically re-establish the connection as soon as you attempt to access the Internet again. If your Internet is charged by time you may want to select this option in order to save money.
- **PPP IP extension:** Select this option to get the public IP address from the PPP server to your

PC, and the NAT and SPI Firewall will be closed. Sometimes you can think it as bridge while PPP dialing in the router. It's a special feature deployed by some ISP. Unless your ISP specifically requires this setup, do not select it.

- **Use Static IPv4 Address:** If your ISP gives you a static **WAN**, **Gateway** and **DNS** IP address, select this option to enter them manually.
- **Enable PPP Debug Mode:** Select this option to debug the PPP function and you can see many PPP log information in the System Log. Only PPP has this debug Mode.
- **Bridge PPPoE Frames Between WAN and Local Ports:** Select this option to start PPP connection in your local PC.
- **Enable IGMP Multicast Proxy:** IGMP (Internet Group Management Protocol) is used to manage multicasting on TCP/IP networks. Some ISPs use IGMP to perform remote configuration for client devices, such as the Router. The default value is disabled, and if you are not sure, please contact your ISP or just leave it.

5. Select a preferred wan interface as the system default gateway in Figure 4-11 and click **Next**.

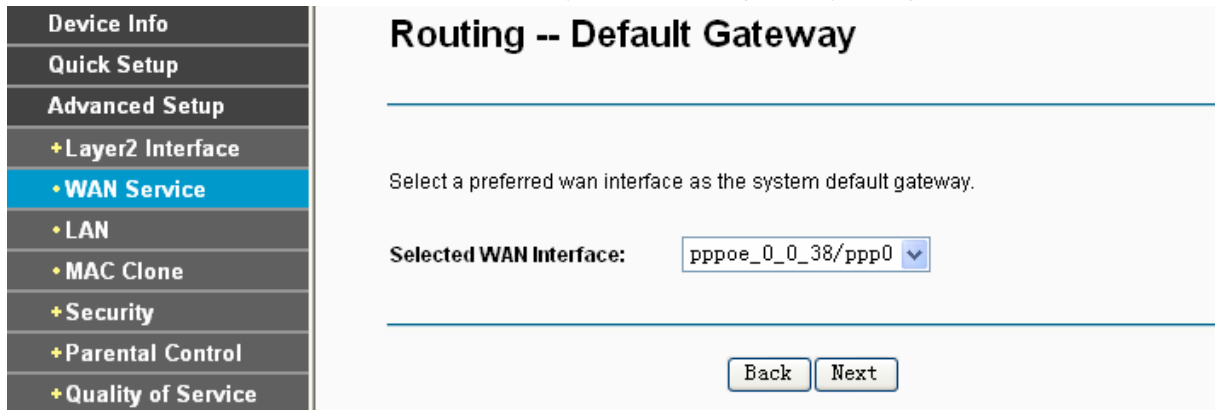

Figure 4-11

6. Configure the DNS Server Addresses on the screen below and click **Next**.

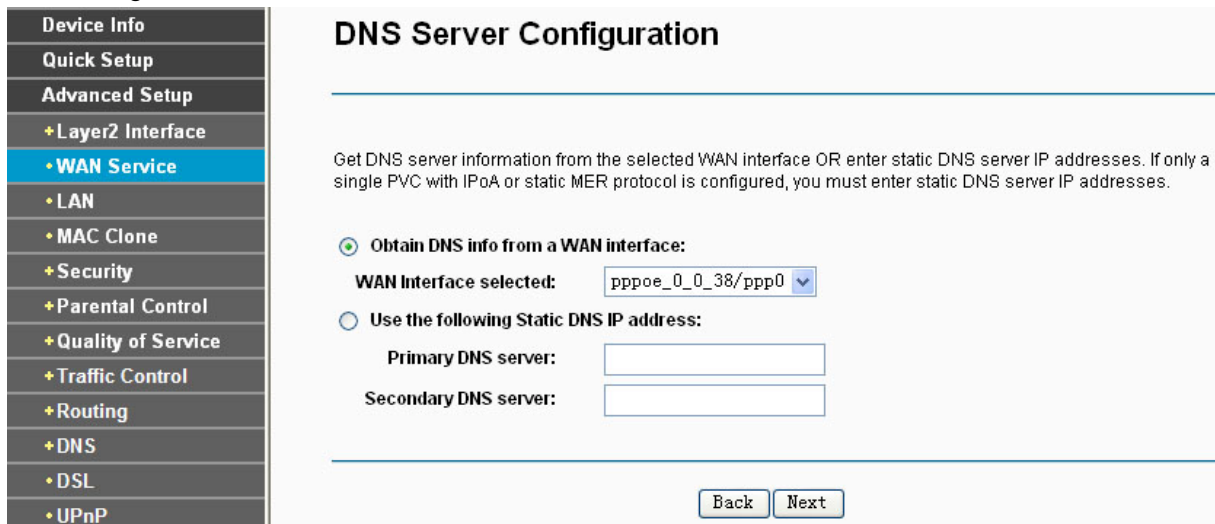

Figure 4-12

- **Obtain DNS info from a WAN Interface:** You can select this option to automatically get DNS server information from the selected WAN interface.
- **Use the following Static DNS IP Address:** You can select this option to manually enter the primary and /or optional secondary DNS server IP addresses provided by your ISP.

Note:

If only single PVC with IPoA is configured, you must enter static DNS server IP addresses.

- On the next screen you will see the detailed settings you've made. Please click the **Apply/Save** button to save these settings.

WAN Setup - Summary

Make sure that the settings below match the settings provided by your ISP.

PORT / VPI / VCI:	0 / 0 / 38
Connection Type:	PPPoE
Service Name:	pppoe_0_0_38
Service Category:	UBR
IP Address:	Automatically Assigned
Service State:	Enabled
NAT:	Enabled
Full Cone NAT:	Disabled
SPI Firewall:	Enabled
IGMP Multicast:	Disabled
Quality Of Service:	Disabled

Click "Save/Apply" to have this interface to be effective. Click "Back" to make any modifications.

[Back](#) [Apply/Save](#)

Figure 4-13

- On the next screen you will see the WAN Port Information Table with the new configuration.

Wide Area Network (WAN) Service Setup

Choose Add, or Remove to configure a WAN service over a selected interface.
ETH and PTM/ATM service can not coexist.

Interface	Description	Type	Vlan8021p	VlanMuxId	ConnId	IGMP	NAT	SPI Firewall	Remove	Edit
atm0	br_0_0_32	Bridge	N/A	N/A	N/A	Disabled	Disabled	Disabled	<input type="checkbox"/>	Edit
atm1	br_0_1_33	Bridge	N/A	N/A	N/A	Disabled	Disabled	Disabled	<input type="checkbox"/>	Edit
atm2	br_0_0_35	Bridge	N/A	N/A	N/A	Disabled	Disabled	Disabled	<input type="checkbox"/>	Edit
atm3	br_0_0_100	Bridge	N/A	N/A	N/A	Disabled	Disabled	Disabled	<input type="checkbox"/>	Edit
atm4	br_0_8_35	Bridge	N/A	N/A	N/A	Disabled	Disabled	Disabled	<input type="checkbox"/>	Edit
atm5	br_0_8_81	Bridge	N/A	N/A	N/A	Disabled	Disabled	Disabled	<input type="checkbox"/>	Edit
atm6	br_0_0_200	Bridge	N/A	N/A	N/A	Disabled	Disabled	Disabled	<input type="checkbox"/>	Edit
ppp0	pppoe_0_0_38	PPPoE	N/A	N/A	N/A	Disabled	Enabled	Enabled	<input type="checkbox"/>	Edit

[Add](#) [Remove](#)

Figure 4-14

- Remove:** Select the check box in the table above and then click **Remove**, the corresponding interface will be deleted in the table.

4.4.2.2 ATM-EoA-IPoE

If your ISP provides an **IPoE** connection and you need to use an ATM Interface, follow the steps below to add a WAN service over a selected ATM interface:

1. Add a **new** ATM interface and select **EoA** option for DSL Link Type ([4.4.1.1 ATM interface](#)).
2. Click the **Add** button on the screen (as shown Figure 4-7). Select WAN Service Interface over ATM PVC on the next screen (as shown Figure 4-8).
3. If your ISP provides an IPoE connection, select **IPoE** option for the **WAN service type** on the screen (as shown Figure 4-9), and click **Next** button to continue.
4. Enter parameters in the following blanks to configure the WAN IP Address and click **Next**.

Figure 4-15

- **Obtain an IP address automatically:** Select this option, the Router will be able to obtain IP network information dynamically from a DHCP server provided by your ISP.

Note:

- 1) The response message from a DHCP server typically contains a number of configuration parameters (DHCP options) for the Router. The DHCP options include IP network information, and also the vendor-specific options. In some cases, the Router is implemented to perform user-defined operations (as shown below). You can implement your own treatment of all such options.
- 2) If the Router is functioning as a DHCP client, it must identify itself in option 61 (client-identifier) in every DHCP message. DUID/IAID is portion of option 61.
 - **Option 60 Vendor ID:** The option code 60 used to identify Vendor class.
 - **Option 61 IAID:** IAID (Identity Association ID) assigns an Identity Association ID to individual interfaces. In cases where the device is functioning with a single DHCP client identity, it must use value 1 for IAID for all DHCP interactions. In cases where the device is functioning with multiple DHCP client identities, the values of IAID have to start at 1 for the first identity and be incremented for each subsequent identity. For example, the device may use IAID value 1 for the first physical interface and value 2 for the second.

Alternatively, the device may use IAID value 1 for the virtual circuit corresponding to the first connection object in the data model and value 2 for the second connection object in the data model.

- **Option 61 DUID:** Specifies the name of the interface whose link-layer address the server is to use as its DUID (DHCP Unique Identifier). You must enter a value for this parameter or the server will not start. When the server starts, the DUID is written to the system log.
 - **Option 125:** The option 125 allows DHCP server to be pre-configured with policy for handling classes of devices in a certain way without requiring DHCP server to be able to parse the unique format used in client-identifier option.
- **Use the following IP Address:** If you are provided with a static IP/gateway Address, please select this option, and then enter the **WAN IP Address**, **WAN Subnet Mask** and **WAN gateway IP Address** manually.
5. You will see the next screen as below. You can enable the **NAT**, **SPI Firewall**, and **IGMP Multicast**, if you are not sure about the settings, just leave the default settings. Click **Next**.

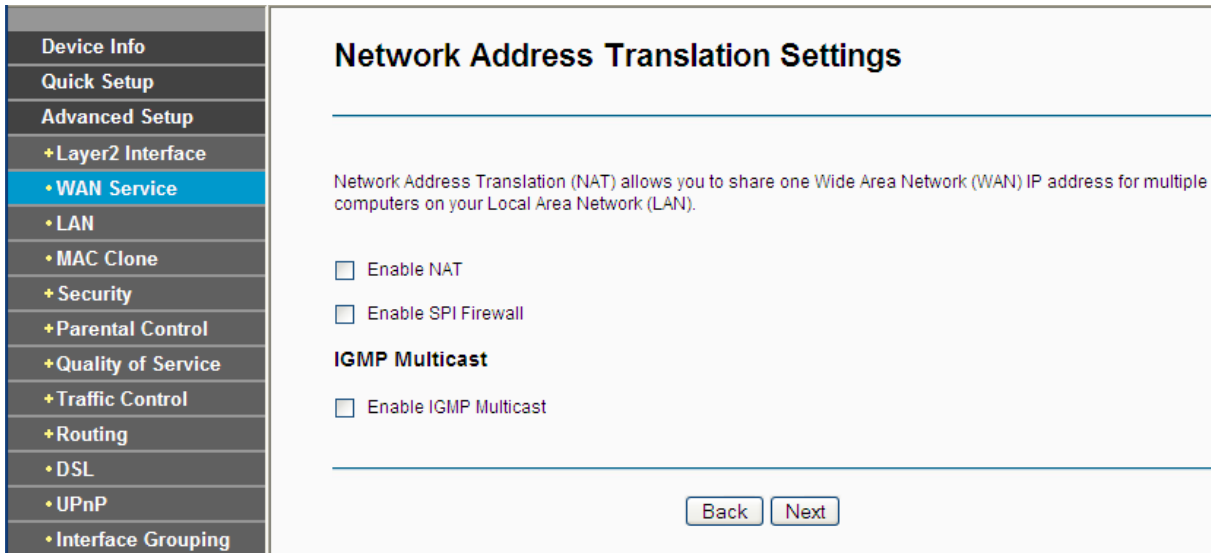

Figure 4-16

- **Enable NAT:** This technology translates the IP addresses of a local area network to a different IP address for the Internet. If this Router is hosting your network's connection to the Internet, please select the check box. If another Router exists in your network, you don't need to select the option.
- **Enable SPI Firewall:** A SPI firewall enhances network's security. Select the option to use a firewall, or else without a firewall.
- **Enable IGMP Multicast:** This is disabled by default. This setting will not allow IGMP (Internet Group Management Protocol) packets to be forwarded to the LAN. IGMP is used to manage multicasting on TCP/IP networks. Most users will not need to enable this. Some ISPs use IGMP to perform remote configuration for client devices, such as the Router. If you are unsure, check with your ISP.

 **Note:**

If you select the **Enable NAT** checkbox, the **NAT** menu will be added to the Web-based Utility. We will describe the detailed configuration in [4.4.5 NAT](#).

6. Select a preferred **WAN** interface as the system default gateway and click **Next**.

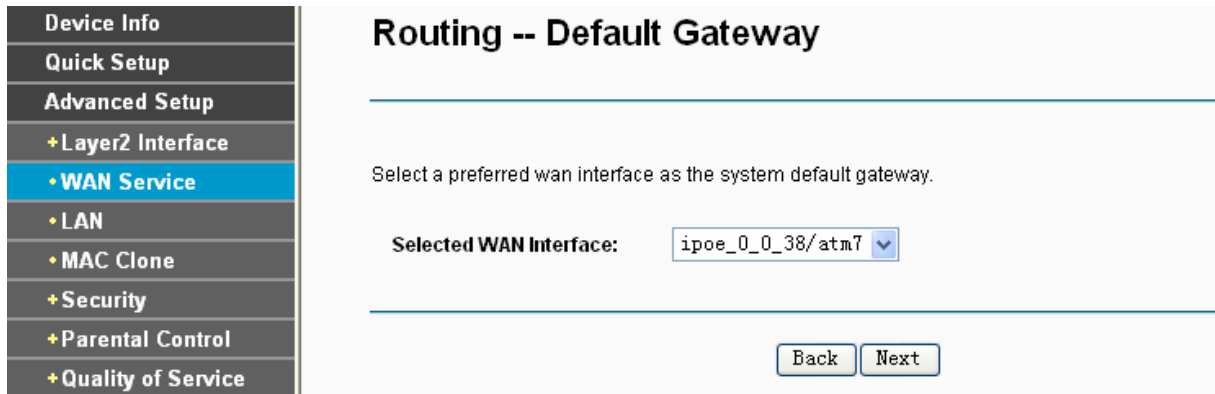

Figure 4-17

7. Configure the DNS Server Addresses on the screen as follows.

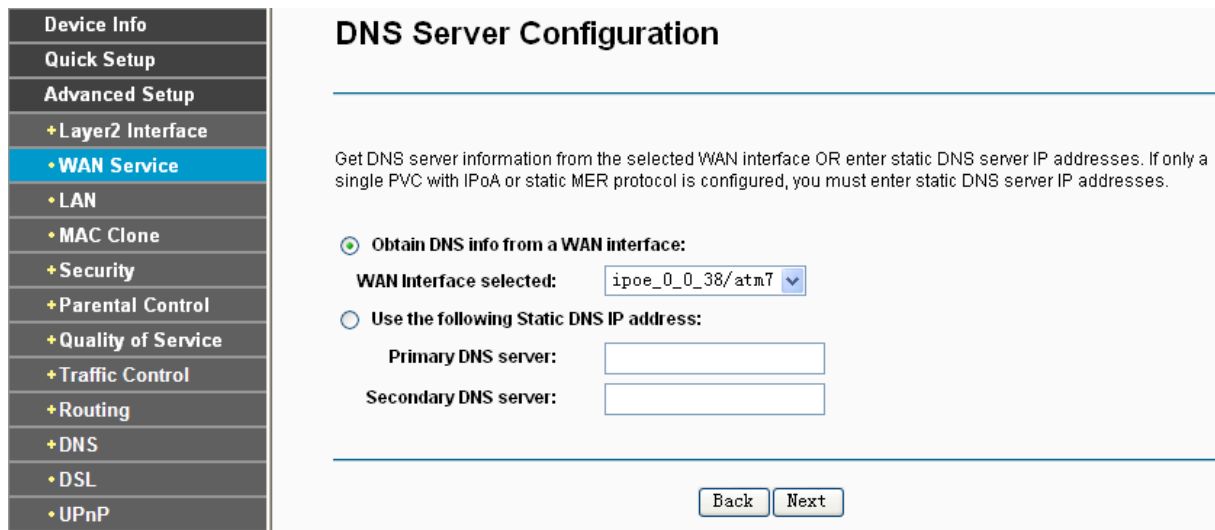

Figure 4-18

Note:

If only single PVC with IPoA is configured, you must enter static DNS server IP addresses.

8. On the next screen (as shown Figure 4-19) you will see the detailed settings you've made. Please click the **Apply/Save** button to save these settings.

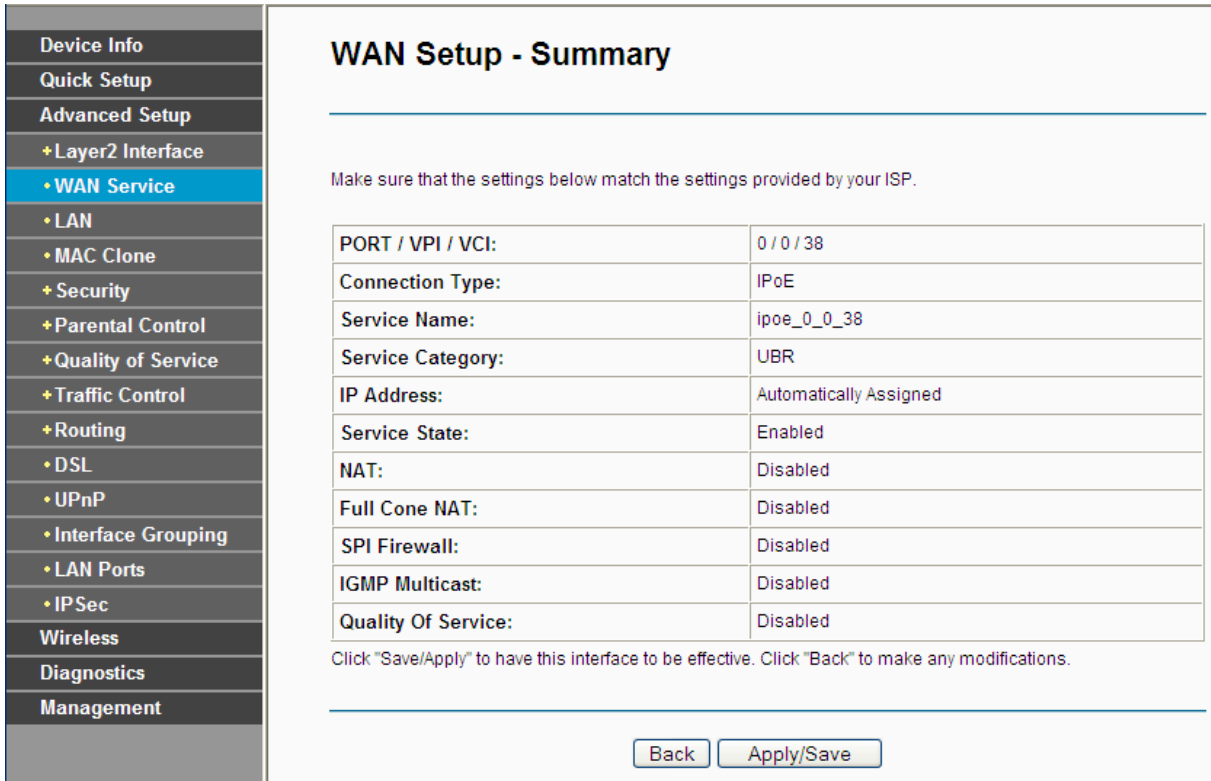

Figure 4-19

4.4.2.3 ATM-EoA-Bridging

If you want to adopt the **Bridge** service and you need to use an ATM Interface, follow the steps below to add a WAN service over a selected ATM interface:

1. Add a new ATM interface and select **EoA** option for DSL Link Type (see [4.4.1.1 ATM interface](#)).
2. Click the **Add** button on the screen Figure 4-7. Select WAN Service Interface over ATM PVC on the next screen (as shown Figure 4-8).
3. Select **Bridging** option for the **WAN service type** on the screen (as shown Figure 4-9), and click **Next** button to continue.
4. On the screen (as shown Figure 4-13) you will see the detailed settings you've made. Please click the **Apply/Save** button to save these settings.

4.4.2.4 ATM-PPPoA

If your ISP provides a **PPPoA** connection and you need to use an ATM Interface, follow the steps below to add a WAN service over a selected ATM interface:

1. Add a new ATM interface and select **PPPoA** option for DSL Link Type (see [4.4.1.1 ATM interface](#)).
2. Click the **Add** button on the screen Figure 4-7 and the next configuration is similar to **PPPoE**, (see section [4.4.2.1 ATM-EoA-PPPoE](#)). The difference is that you don't need to set the **PPPoE Service Name** and **Bridge PPPoE Frames Between WAN and Local Ports** on the screen of Figure 4-10.

4.4.2.5 ATM-IPoA

If your ISP provides an **IPoA** connection and you need to use an ATM Interface, follow the steps below to add a WAN service over a selected ATM interface.

1. Add a new ATM interface and select **IPoA** option for DSL Link Type (see [4.4.1.1 ATM interface](#)).
2. Click the **Add** button on the screen Figure 4-7 and the next configuration is similar to **IPoE** (see section [4.4.2.2 ATM-EoA-IPoE](#)). The difference is that you have to manually set the Static IP Address on the screen of Figure 4-15, and the Static IP Address for DNS Server on the screen of Figure 4-18.

 **Note:**

ETH and ATM service can not coexist. If the ATM Interface had configured, you cannot configure any other WAN service over the ETH Interface until the ATM Interface is deleted.

4.4.2.6 ETH-PPPoE

If your ISP provides a **PPPoE** connection and you need to use an **ETH** Interface, follow the steps below to add a WAN service over a selected ETH interface:

1. Add a new **ETH** interface on the screen of [4.4.1.2 ETH interface](#).
2. Click the **Add** button on the screen Figure 4-7 and the following configuration is similar to **PPPoE** over ATM interface (see section [4.4.2.1 ATM-EoA-PPPoE](#)).

4.4.2.7 ETH-IPoE

If your ISP provides an **IPoE** connection and you want to use an **ETH** Interface, follow the steps below to add a WAN service over a selected ETH interface:

1. Add a new **ETH** interface on the screen of [4.4.1.2 ETH interface](#).
2. Click the **Add** button on the screen Figure 4-7 and the next configuration is similar to **IPoE** over ATM interface (see section [4.4.2.2 ATM-EoA-IPoE](#)).

4.4.2.8 ETH-Bridge

If you want to adopt the **Bridge** service and you need to use an **ETH** Interface, follow the steps below to add a WAN service over a selected ETH interface:

1. Add a new **ETH** interface on the screen of [4.4.1.2 ETH interface](#).
2. Click the **Add** button on the screen Figure 4-7 and the next configuration is similar to **Bridge** over ATM interface (see section [4.4.2.3 ATM-EoA-Bridg](#)).

 **Note:**

For ETH-PPPoE, ETH-IPoE and ETH-Bridge, the Bridging option will display in the screen of Figure 4-20 only when VLAN MUX Mode is selected for Connection Mode on the screen of Figure 4-5. You have to set the **802.1P Priority** and **802.1Q VLAN ID**.

WAN Service Configuration

Select WAN service type:

PPP over Ethernet (PPPoE)

IP over Ethernet

Bridging

Enter Service Description:

Enter 802.1P Priority [0-7]:

Enter 802.1Q VLAN ID [0-4094]:

Figure 4-20

4.4.3 LAN

Choose “**Advanced Setup**”→“**LAN**”, and you will see the LAN screen (shown in Figure 4-21), the section allows you to configure the Router’s LAN ports settings.

Device Info

Quick Setup

Advanced Setup

+ Layer2 Interface

+ WAN Service

+ LAN

+ MAC Clone

+ Security

+ Parental Control

+ Quality of Service

+ Traffic Control

+ Routing

+ DNS

+ DSL

+ UPnP

+ Interface Grouping

+ LAN Ports

+ IP Sec

Wireless

Diagnostics

Management

Local Area Network (LAN) Setup

Configure the DSL Modem Router IP Address and Subnet Mask for LAN interface. GroupName Default

IP Address:

Subnet Mask:

Enable IGMP Snooping

Standard Mode

Blocking Mode

NOTE: If "LAN side firewall" is enabled, all PCs in the LAN will not able to manage the Router. Please make sure you have set a PC allowed to manage the Router on "Security->IP Filtering->Incoming" page.

Enable LAN side firewall

Disable DHCP Server

Enable DHCP Server

Start IP Address:

End IP Address:

Leased Time (hour):

Static IP Lease List: (A maximum 32 entries can be configured)

MAC Address	IP Address	Remove

Configure the second IP Address and Subnet Mask for LAN interface

Figure 4-21

- **IP Address:** You can configure the Router's IP Address and Subnet Mask for LAN Interface.
 - **IP Address:** Enter the Router's local IP Address, then you can access to the Web-based Utility via the IP Address, the default value is 192.168.1.1.
 - **Subnet Mask:** Enter the Router's Subnet Mask, the default value is 255.255.255.0.
- **Enable IGMP Snooping:** If you select the option, please choose the IGMP Mode: Standard Mode or Blocking Mode.
- **DHCP Server:** These settings allow you to configure the Router's Dynamic Host Configuration Protocol (DHCP) server function. The DHCP server is enabled by default for the Router's Ethernet LAN interface. DHCP service will supply IP settings to computers which are configured to automatically obtain IP settings that are connected to the Router though the Ethernet port. When the Router is set for DHCP, it becomes the default gateway for DHCP client connected to it. Keep in mind that if you change the IP address of the Router, you must change the range of IP addresses in the pool used for DHCP on the LAN.

- **Start IP Address:** Enter a value for the DHCP server to start with when issuing IP addresses. Because the default IP address for the Router is 192.168.1.1, the default Start IP Address is **192.168.1.2**, and the Start IP Address must be 192.168.1.2 or greater, but smaller than 192.168.1.254.
 - **End IP Address:** Enter a value for the DHCP server to end with when issuing IP addresses. The End IP Address must be smaller than 192.168.1.254. The default End IP Address is **192.168.1.254**.
 - **Leased Time (hour):** The Leased Time is the amount of time in which a network user will be allowed connection to the Router with their current dynamic IP address. Enter the amount of time, in hours, then the user will be “leased” this dynamic IP address. After the dynamic IP address has expired, the user will be automatically assigned a new dynamic IP address. The default is **24** hours.
- **Static IP Lease List:** The function allows you to specify a reserved IP address for a PC on the LAN, that PC will always obtain the assigned IP address each time when it accesses the DHCP server. Reserved IP addresses should be assigned to servers that require permanent IP settings. Click the **Add Entries** button, and then you will set the rule in the screen as below.

Figure 4-22

- **MAC Address:** The MAC address of the computer on the LAN which you want to reserve an IP.
 - **IP Address:** The IP address you want to reserved to the computer.
- **Configure the second IP Address and Subnet Mask:** You can configure the Router's second IP Address and Subnet Mask for LAN Interface through which you can also access to the Web-based Utility as the default IP Address and Subnet Mask.

Note:

UPnP, DHCP Server and the second IP Address are not available for the connection type of **Bridging** here, they won't display on the preceding screen since only Bridging is selected.

4.4.4 MAC Clone

Choose menu “**Advanced Setup**”→“**MAC Clone**”, you can configure the MAC address of the WAN Interface as shown below.

The WAN Interface List displays the Lay2 Interfaces you have configured on the section [4.4.1 Layer2 Interface](#) and its default MAC Address. If you have not configured corresponding WAN

Service for the interface on the section [4.4.2 WAN Service](#), the blank for MAC Address will display “Need a corresponding WAN Service”.

The last one of WAN Interface List displays your PC’s current address.

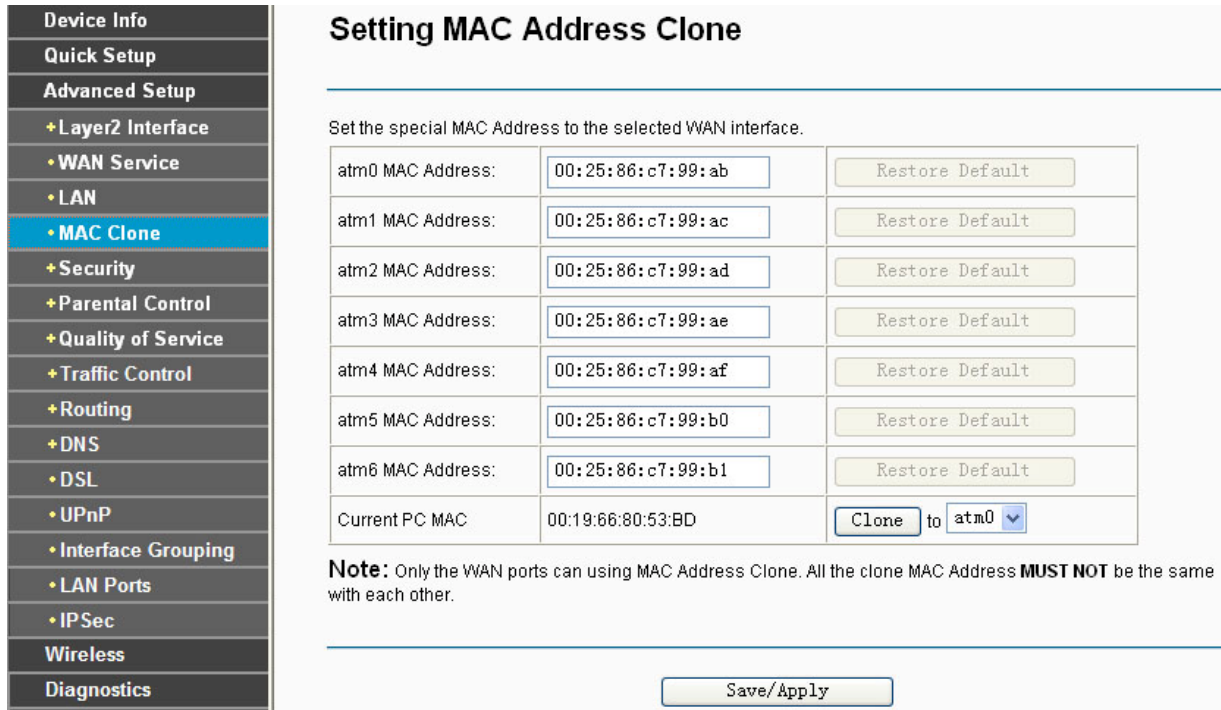

Figure 4-23

Type the new value for the WAN Interface who’s MAC Address you want to change, and click **Save/Apply**.

You can select corresponding WAN Interface from the drop-down list and click **Clone** button to clone your current PC MAC, and then click **Save/Apply**.

Click **Restore Default** button to restore the WAN Interface’s default MAC Address.

Note:

Only the WAN Ports can use MAC Address Clone function. All the clone MAC addresses must not be the same with each other.

4.4.5 NAT

NAT (Network Address Translation) allows you to share one WAN (Wide Area Network) IP address for multiple computers on your LAN (Local Area Network).

Note:

When you select **PPPoA** or **PPPoE** for the WAN Setup, or when you select **Enable NAT** for the type of **IPoA** and **IPoE** connection ([4.4.2 WAN Service](#)), you will see the **NAT** menu in the Web-based Utility (shown in Figure 4-24).

Choose “**Advanced Setup**”→“**NAT**”, there are three submenus under the main menu: **Virtual Servers**, **Port Triggering** and **DMZ Host**. Click any of them, and you will be able to configure the corresponding function.

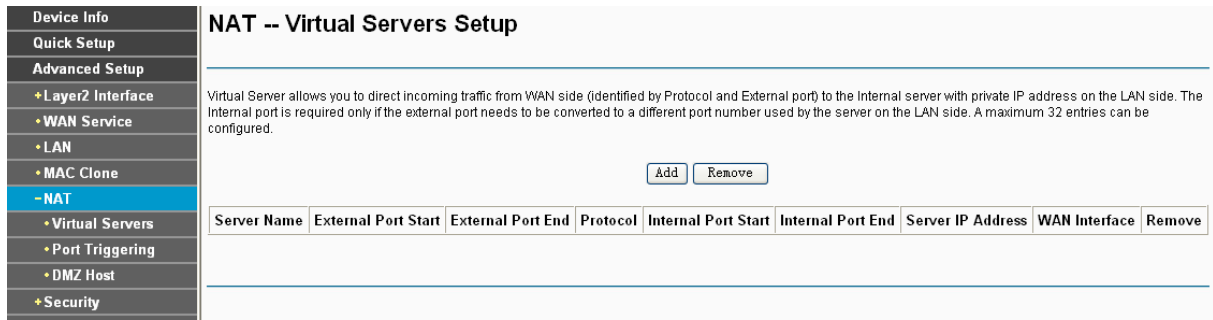

Figure 4-24

4.4.5.1 Virtual Servers

Choose “**Advanced Setup**”→“**NAT**”→“**Virtual Servers**”, you can set up virtual servers on the screen below (shown in Figure 4-25).

Virtual servers can be used for setting up public services on your LAN, such as DNS, Email and FTP. A virtual server is defined as a service port, and all requests from the Internet to this service port will be redirected to the computer specified by the server IP. Any PC that was used for a virtual server must have a static or reserved IP Address because its IP Address may change when using the DHCP function.

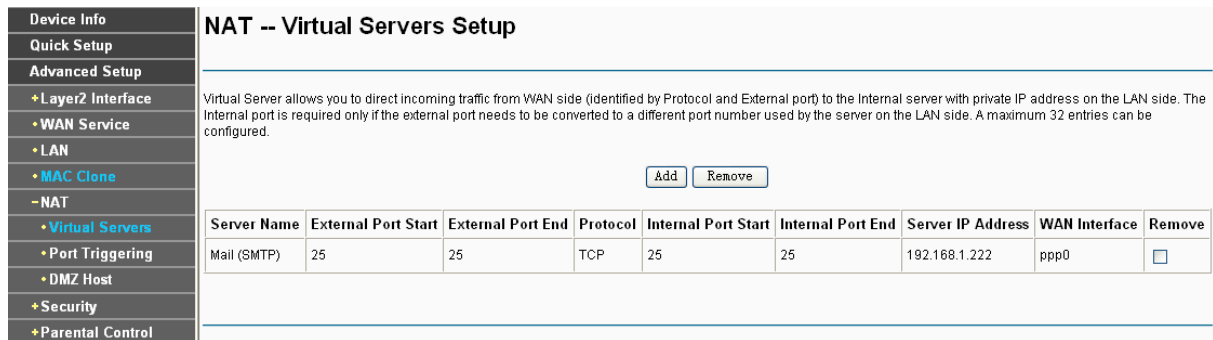

Figure 4-25

- **Virtual Server Table:** The table indicates the information about the Virtual Server entries.
 - **Server Name:** This is the name of the **Virtual Server**. It is exclusive and must be filled in.
 - **External Port Start:** The base number of External Ports. You can type a service port or leave it blank.
 - **External Port End:** The end number of External Ports. You can type a service port or leave it blank.
 - **Protocol:** The protocol used for this application, **TCP**, **UDP**, or **TCP/UDP**.
 - **Internal Port Start:** The base number of Internal Ports. You can type a service port or leave it blank.
 - **Internal Port End:** The end number of Internal Ports. You can type a service port or leave it blank.
 - **Server IP Address:** The IP Address of the PC providing the service application.
 - **WAN Interface:** The WAN Service Interface providing the service application.
- **Add:** Click the **Add** button to add a new entry.

- **Remove:** Select the check box in the table (shown in Figure 4-25) and then click the **Remove** button, then the corresponding entry will be deleted in the table.

To add a virtual server entry:

1. Click the **Add** button on the preceding screen Figure 4-25, and then you will see the new Virtual Server in the next screen as shown in Figure 4-26.

NAT -- Virtual Servers

Select the service name, and enter the server IP address and click "Apply/Save" to forward IP packets for this service to the specified server.

NOTE: The "Internal Port End" cannot be modified directly. Normally, it is set to the same value as "External Port End". However, if you modify "Internal Port Start", then "Internal Port End" will be set to the same value as "Internal Port Start".

Remaining number of entries that can be configured: 32

Use Interface:

Service Name:

Select a Service:

Custom Service:

Server IP Address:

External Port Start	External Port End	Protocol	Internal Port Start	Internal Port End
<input type="text" value="25"/>	<input type="text" value="25"/>	TCP	<input type="text" value="25"/>	<input type="text" value="25"/>
<input type="text"/>	<input type="text"/>	TCP	<input type="text"/>	<input type="text"/>
<input type="text"/>	<input type="text"/>	TCP	<input type="text"/>	<input type="text"/>
<input type="text"/>	<input type="text"/>	TCP	<input type="text"/>	<input type="text"/>
<input type="text"/>	<input type="text"/>	TCP	<input type="text"/>	<input type="text"/>
<input type="text"/>	<input type="text"/>	TCP	<input type="text"/>	<input type="text"/>
<input type="text"/>	<input type="text"/>	TCP	<input type="text"/>	<input type="text"/>
<input type="text"/>	<input type="text"/>	TCP	<input type="text"/>	<input type="text"/>
<input type="text"/>	<input type="text"/>	TCP	<input type="text"/>	<input type="text"/>
<input type="text"/>	<input type="text"/>	TCP	<input type="text"/>	<input type="text"/>
<input type="text"/>	<input type="text"/>	TCP	<input type="text"/>	<input type="text"/>
<input type="text"/>	<input type="text"/>	TCP	<input type="text"/>	<input type="text"/>
<input type="text"/>	<input type="text"/>	TCP	<input type="text"/>	<input type="text"/>
<input type="text"/>	<input type="text"/>	TCP	<input type="text"/>	<input type="text"/>
<input type="text"/>	<input type="text"/>	TCP	<input type="text"/>	<input type="text"/>

Figure 4-26

2. Select the Interface which you want to use from the drop-down list.
3. Select the service which you want to use from the drop-down list. If the list does not have the service you need, type the name of the custom service in the text box.
4. Type the IP Address of the computer in the **Server IP Address** text box.
5. Enter the External Port Start, External Port End, Internal Port Start and Internal Port End in the table, and then select the protocol used for this Virtual Server, **TCP**, **UDP** or **All**.
6. Click **Save/Apply** to enable virtual server and then you will see your setting as shown in Figure 4-25.

Note:

If you select the service from the drop-down list, the External Port Start, External Port End, Internal Port Start, Internal Port End and the Protocol will be added in the table automatically. You only need to enter the Server IP Address for the Virtual Server.

4.4.5.2 Port Triggering

Choose “**Advanced Setup**”→“**NAT**”→“**Port Triggering**”, you can set Port Triggering on the screen (shown in Figure 4-27).

Some applications require that specific ports in the Router's firewall should be opened for access by remote devices. Port Trigger dynamically opens up the 'Open Ports' in the firewall when an application on the LAN initiates a TCP/UDP connection to a remote device using the triggering ports. The Router allows the remote party from the WAN side to establish new connections back to the application on the LAN side using the open ports. A maximum 32 entries can be configured.

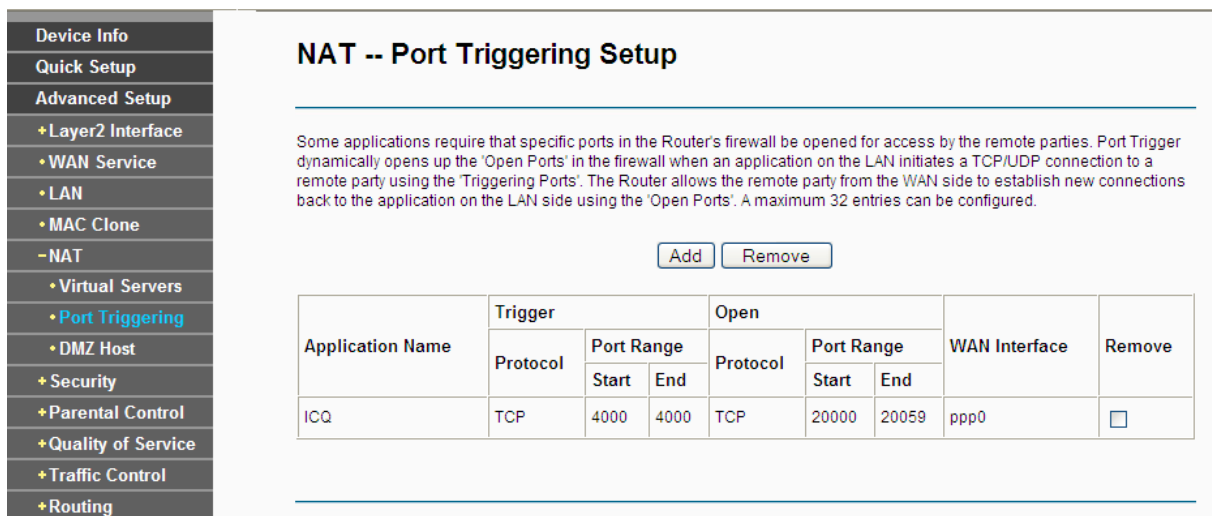

Figure 4-27

- **Port Triggering Table:** The table indicates the information about the Port Triggering entries.
 - **Application (Name):** This is the name of the **Port Triggering**. It is exclusive and must be filled.
 - **Trigger:** It includes the Protocol and the Start and End value of the Trigger Ports.
 - **Open:** It includes the Protocol and the Start and End value of the Open Ports.
 - **WAN Interface:** The WAN Service Interface setting the Port Triggering.
- **Add:** Click the button to add a new entry.
- **Remove:** Select the check box in the table (shown in Figure 4-27) and then click the **Remove** button, then the corresponding entry will be deleted in the table.

To add a new Port Triggering:

1. Click the **Add** button in Figure 4-27, and then you will see the new Port Triggering in the next screen as shown in Figure 4-28.

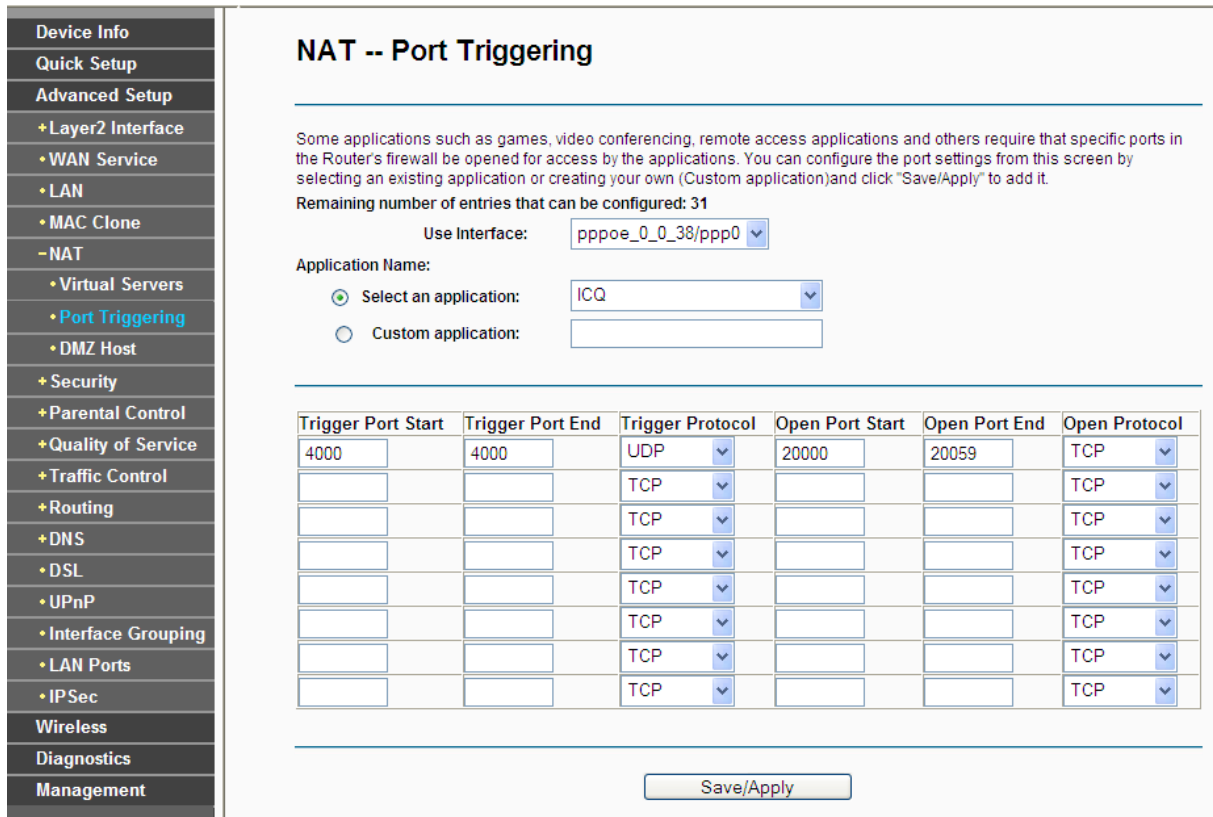

Figure 4-28

2. Select the application from the drop-down list. If the list does not have the application that you want, select the **Custom application** radio button, and type the name of the custom application in the text box.
3. Enter the **Trigger Port Start**, **Trigger Port End**, **Open Port Start** and **Open Port End** in the table, and then select the **Trigger protocol** and **Open protocol**, **TCP**, **UDP** or **All**.
4. Click **Save/Apply** to enable the settings and then you will see you settings as shown in Figure 4-27.

Note:

If you select the application from the drop-down list, the External Port Start, External Port End, Internal Port Start, Internal Port End and the Protocol will be added in the table automatically.

4.4.5.3 DMZ Host

Choose **“Advanced Setup”**→**“NAT”**→**“DMZ Host”**, you can set up DMZ Host on the screen (shown in Figure 4-29).

The DMZ host feature can make a local host be exposed to the Internet for a special-purpose service, such as online gaming or video conferencing.

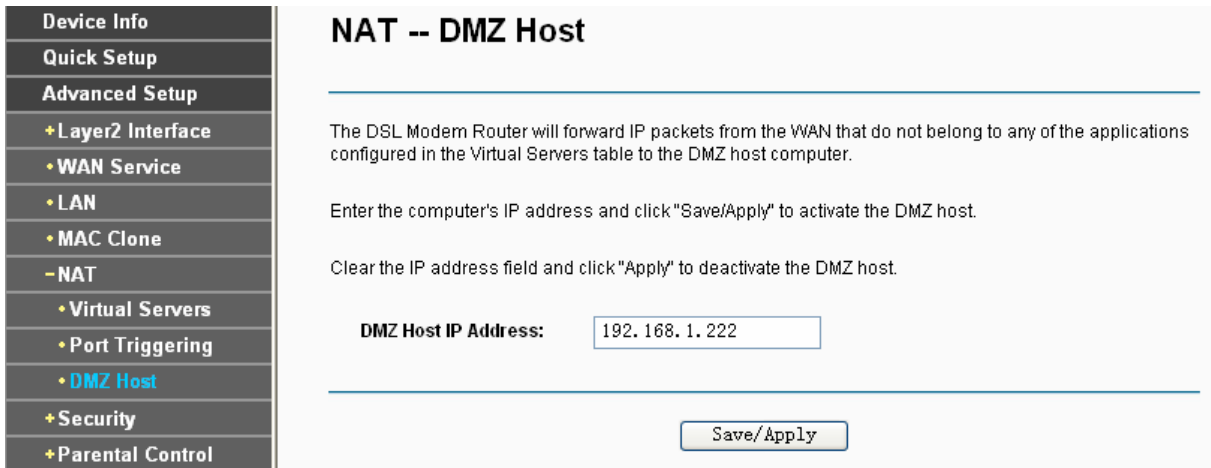

Figure 4-29

To add a new DMZ Host:

You can enter the computer's IP address and then click **Save/Apply** to activate the DMZ host you set on this page.

Note:

DMZ host forwards all the ports at the same time. Any PC whose port is being forwarded must have its DHCP client function disabled and should have a new static IP Address assigned to it because its IP Address may change while using the DHCP function.

4.4.6 Security

Choose **“Advanced Setup”**→**“Security”**, and you will see the security screen including **IP Filtering** and **MAC Filtering** (only effective in Bridging mode) submenus.



Figure 4-30

4.4.6.1 IP Filtering

The IP address filtering feature makes it possible for administrators to control user's access to the Internet, which is based on user's IP. The IP address filtering includes **Outgoing** and **Incoming**, the detailed descriptions are provided below.

IP Filtering - Outgoing

Choose **“Advanced Setup”**→**“Security”**→**“IP Filtering”**→**“Outgoing”**, you can configure Outgoing Filtering rules on the screen (shown in Figure 4-31).

The Outgoing IP Filtering feature allows you to control some IP traffic from LAN to access to some specifically addresses. By default, all outgoing IP traffic from LAN is allowed, but some IP traffic can be **BLOCKED** by setting up filters.

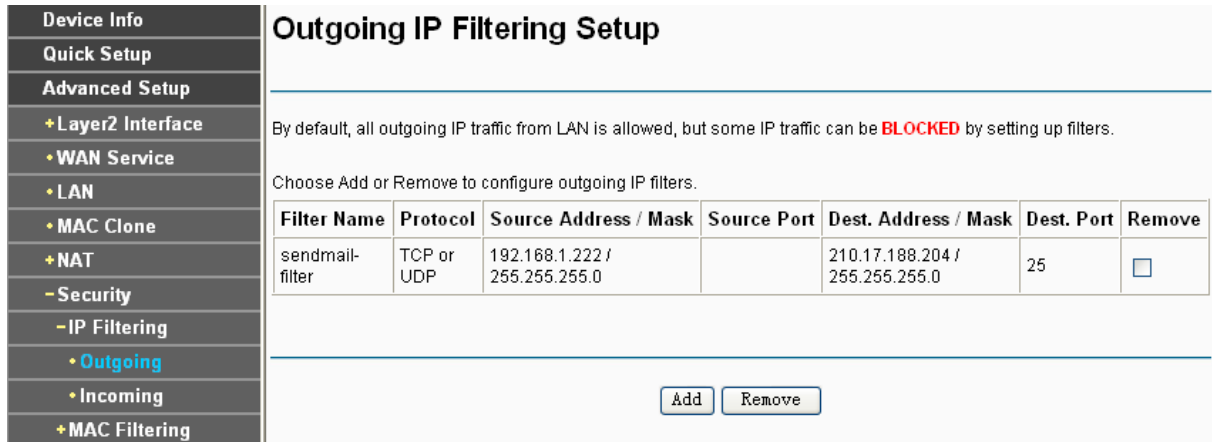

Figure 4-31

Set up an Outgoing IP Filtering rule:

1. Click the **Add** button in Figure 4-31, and you will see the next screen as shown in Figure 4-32.

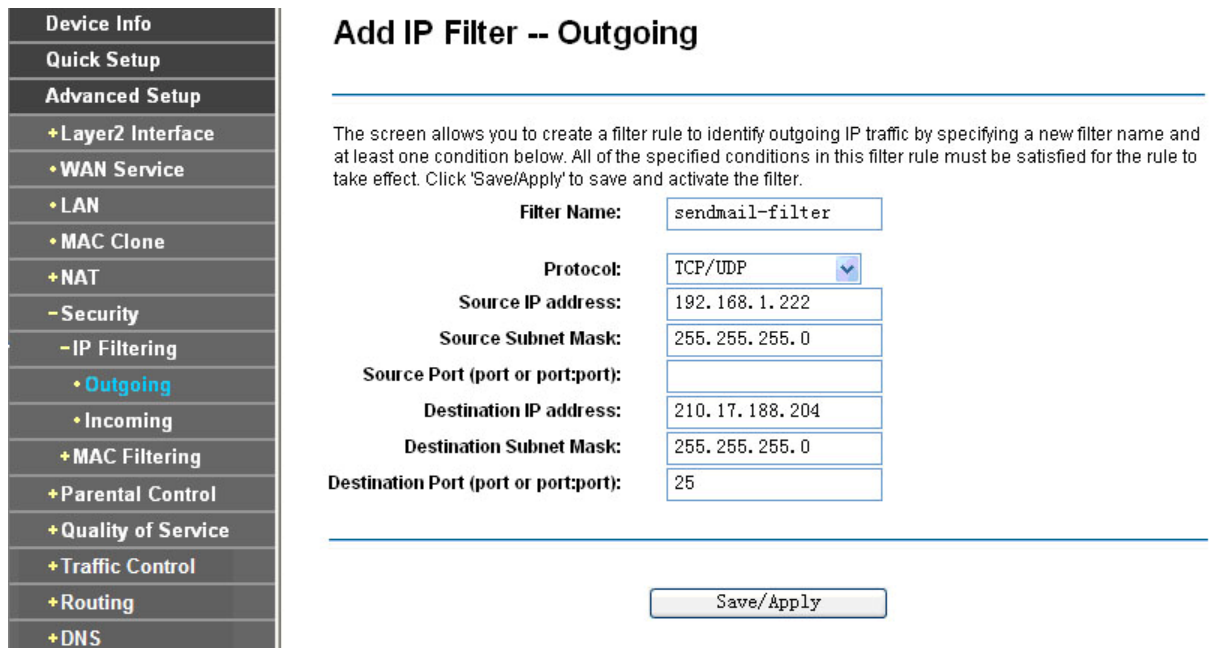

Figure 4-32

2. Enter the **Filter name** for the rule, it is exclusive and must be filled.
3. Select the **protocol: TCP/UDP, TCP, UDP or ICMP** in the drop-down list for the connection between the Source IP address and Destination IP address.
4. Enter a **Source IP Address** in dotted-decimal notation format and then type the **Source Subnet Mask** and **Source Port** (port or port: port) in the text boxes separately.
5. Enter a **Destination IP Address** in dotted-decimal notation format and then type the **Destination Subnet Mask** and **Destination Port** (port or port: port) in the text boxes separately.
6. Click **Save/Apply** to save this entry.

Note:

When you add an Outgoing IP Filtering entry, you must configure at least one condition on the preceding screen except the Filter name. If you leave the Protocol blank, it means that the rule is effective to all protocols, if you leave the Source IP Address and/or Destination IP Address blank, it suggests that all Source IP Addresses and/or Destination IP Addresses are controlled by the rule, if you leave the Source Port and/or Destination Port blank, it suggests that all Source Ports and/or Destination Ports are controlled by the rule.

IP Filtering - Incoming

Choose “**Advanced Setup**”→“**Security**”→“**IP Filtering**”→“**Incoming**”, you can configure Incoming Filtering rules on the screen as shown in Figure 4-33.

The Incoming IP Filtering feature allows some IP traffic from WAN to access some local addresses. By default, all incoming IP traffic from the WAN is blocked when the firewall is enabled. However, some IP traffic can be **ACCEPTED** by setting up filters.

Incoming IP Filtering Setup

When the firewall is enabled on a WAN or LAN interface, all incoming IP traffic is BLOCKED. However, some IP traffic can be **ACCEPTED** by setting up filters.

Choose Add or Remove to configure incoming IP filters.

Filter Name	Interfaces	Protocol	Source Address / Mask	Source Port	Dest. Address / Mask	Dest. Port	Remove
recvmail-filter	ppp0,br0	TCP or UDP	210.17.188.204 / 255.255.255.0			110	<input type="checkbox"/>

Figure 4-33

Set up an Incoming IP Filtering rule:

1. Click the **Add** button in Figure 4-33, and then you will see Figure 4-34.

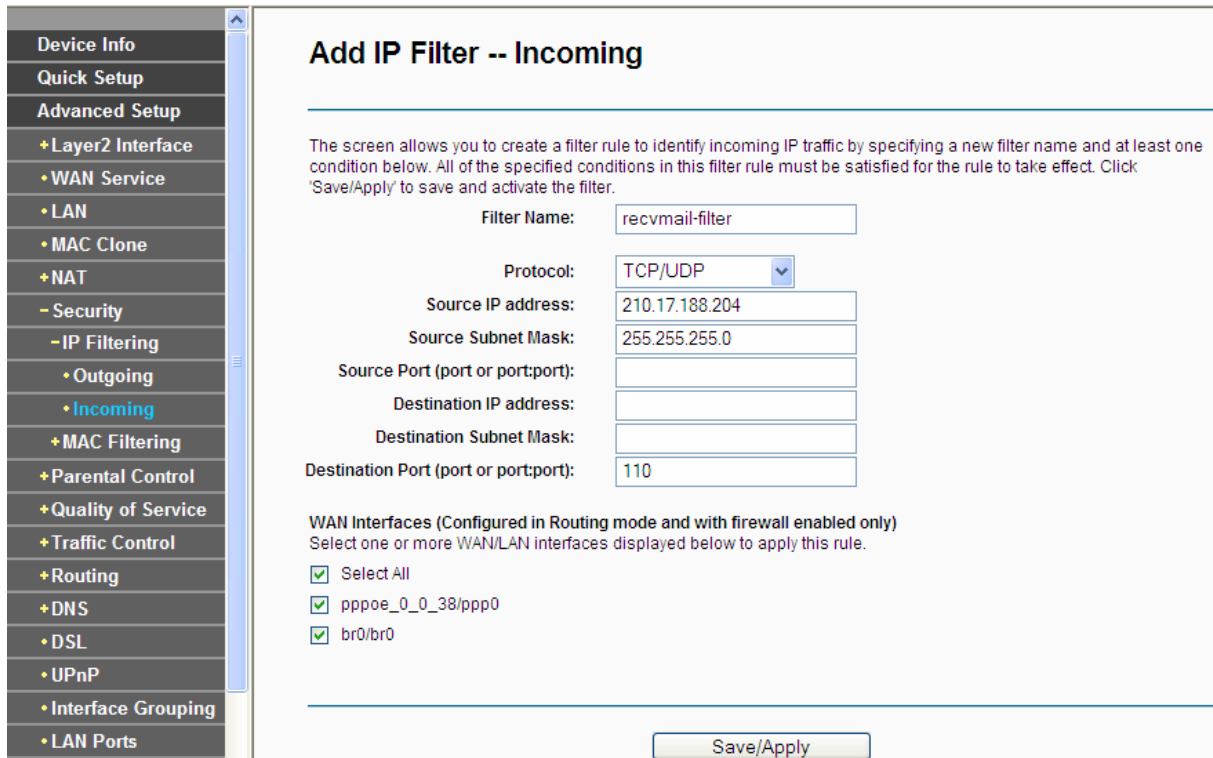

Figure 4-34

2. Enter the **Filter name** for the rule, it is exclusive and must be filled in.
3. Select **Protocol** in the drop-down list, enter **Source IP address**, **Source Subnet Mask**, **Source Port**, **Destination IP address**, **Destination Subnet Mask**, and **Destination Port** for the rule.
4. Select at least one WAN interfaces displayed below to apply this rule.
5. Click **Save/Apply** to save this entry.

Note:

When you add an Incoming IP Filtering entry, you must configure at least one condition on the preceding screen except the Filter name. If you leave **Protocol** blank, it means that the rule is effective to all protocols, if you leave the Source IP address and/or Destination IP address blank, it suggests that all Source IP addresses and/or Destination IP addresses are controlled by the rule, if you leave the Source Port and/or Destination Port blank, it suggests that all Source Ports and/or Destination Ports are controlled by the rule.

4.4.6.2 MAC Filtering

Choose “**Advanced Setup**”→“**Security**”→“**MAC Filtering**”, you can configure MAC Filtering rules on the screen as shown in Figure 4-35. The section allows you to control access to the Internet by users on your local network based on their MAC Address.

Note:

MAC Filtering is only effective on ATM PVC(s) configured in Bridging mode.

- Device Info
- Quick Setup
- Advanced Setup
 - + Layer2 Interface
 - + WAN Service
 - + LAN
 - + MAC Clone
 - + NAT
 - Security
 - + IP Filtering
 - **MAC Filtering**
 - + Parental Control
 - + Quality of Service
 - + Traffic Control
 - + Routing
 - + DSL
 - + UPnP
 - + Interface Grouping
 - + LAN Ports
 - + IPsec
 - Wireless
 - Diagnostics
 - Management

MAC Filtering Setup

MAC Filtering is only effective on ATM PVCs configured in Bridge mode. **FORWARDED** means that all MAC layer frames will be **FORWARDED** except those matching with any of the specified rules in the following table. **BLOCKED** means that all MAC layer frames will be **BLOCKED** except those matching with any of the specified rules in the following table.

MAC Filtering Policy For Each Interface:
WARNING: Changing from one policy to another of an interface will cause all defined rules for that interface to be REMOVED AUTOMATICALLY! You will need to create new rules for the new policy.

Interface	Policy	Change
atrn0	FORWARDED	<input type="checkbox"/>
atrn1	FORWARDED	<input type="checkbox"/>
atrn2	FORWARDED	<input type="checkbox"/>
atrn3	FORWARDED	<input type="checkbox"/>
atrn4	FORWARDED	<input type="checkbox"/>
atrn5	FORWARDED	<input type="checkbox"/>
atrn6	FORWARDED	<input type="checkbox"/>

Choose Add or Remove to configure MAC filtering rules.

Interface	Protocol	Destination MAC	Source MAC	Frame Direction	Remove
atrn0	IGMP	00:11:22:33:44:AA	00:11:22:33:44:BB	BOTH	<input type="checkbox"/>

Figure 4-35

- **Change Policy:** There are two policies for the MAC filters: **FORWARDED** and **BLOCKED**. Select the **Change** checkbox and click the **Change Policy** button to change from one policy to another. When you set **FORWARDED**, it means that all MAC layer frames will be **forwarded** except those matching with any of the specified rules in the table (shown in Figure 4-35). While **BLOCKED** means that all MAC layer frames will be **blocked** except those matching with any of the specified rules in the preceding table.
- **Add:** Click the **Add** button, and then you can add a new MAC Filter in the next screen (shown in Figure 4-35).
- **Remove:** Select the check box in the table (shown in Figure 4-35) and then click the **Remove** button, and then the corresponding entry will be deleted in the table.

To add a MAC Filtering rule:

1. Click the **Add** button in Figure 4-35, and you will see the next screen similar to in Figure 4-36.

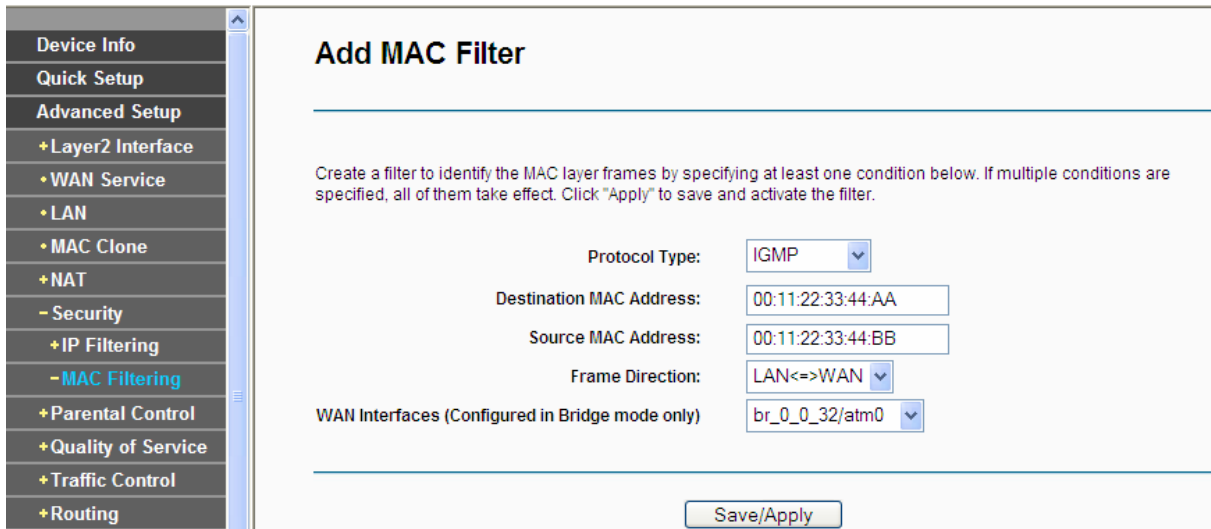

Figure 4-36

2. Select **Protocol Type** in the drop-down list for the rule.
3. Enter **Destination MAC Address** and **Source MAC Address** in the text box.
4. Select **Frame Direction** in the drop-down list for the rule.
5. Select the **WAN interfaces** from the drop-down list.
6. Click **Save/Apply** to save this entry and then you will see your settings as shown in Figure 4-35.

4.4.7 Parental Control

Choose “**Advanced Setup**”→“**Parental Control**”. You can configure the Parental Control on the screen as shown in Figure 4-37. Time Restriction allows you to control the Internet activities of the child by restricting the time of surfing. URL Filter limits every computer connected to the router to access certain websites. These two features work independently.

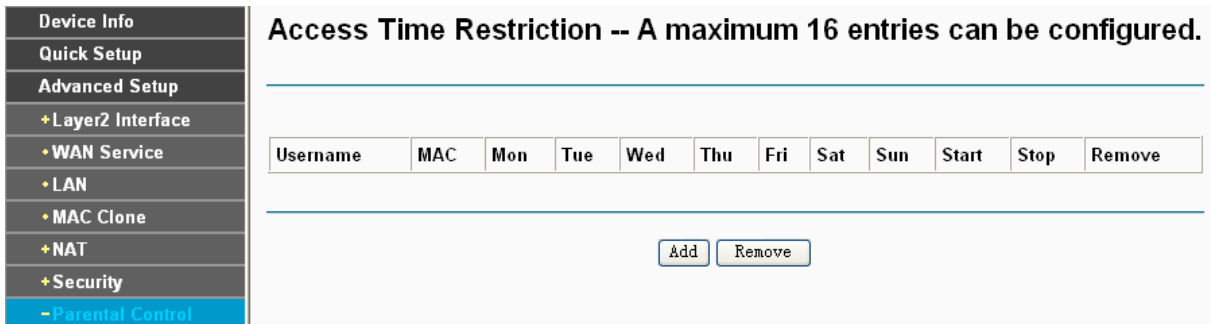

Figure 4-37

4.4.7.1 Time Restriction

This feature allows you add time of day restriction to a special LAN device connected to the Router.

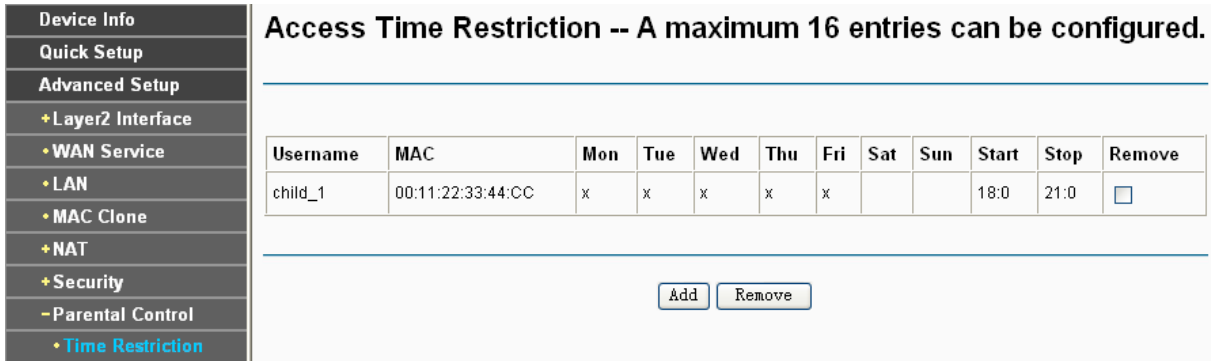

Figure 4-38

To add a Time Restriction entry:

1. Click the **Add** button in Figure 4-38, and then you will see the next screen as shown in Figure 4-39.

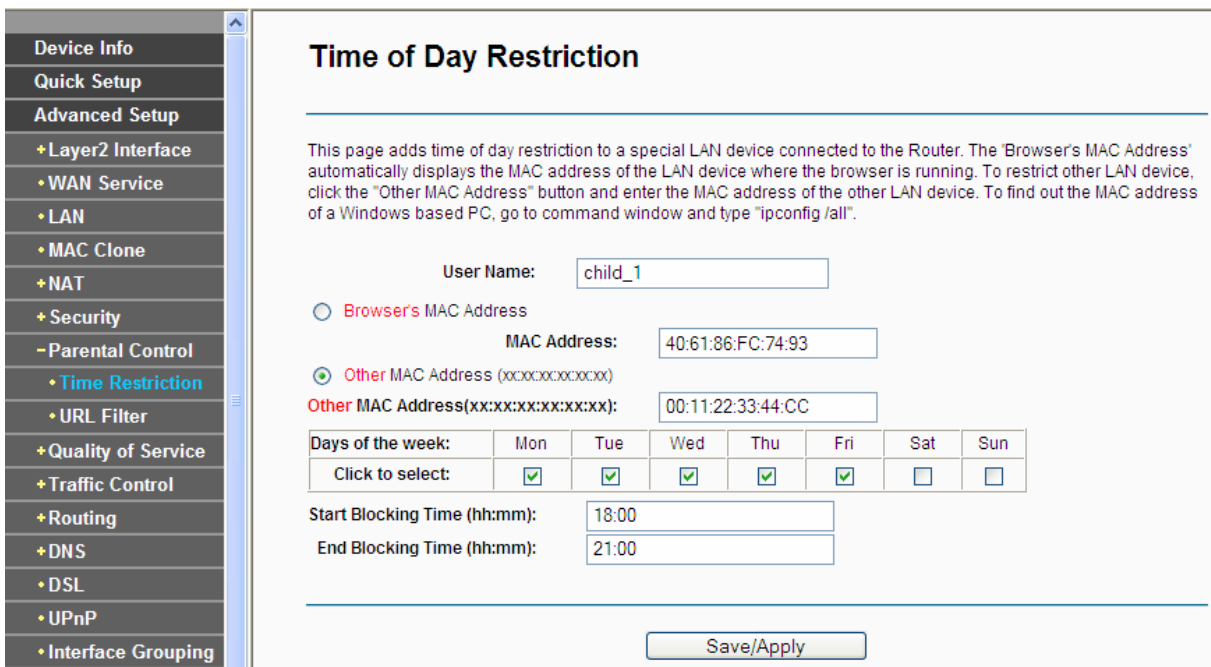

Figure 4-39

2. Enter the **User Name** of the LAN device connected to the Router.
3. To restrict the device where the browser is running, select the **Browser's MAC Address** radio button. The MAC Address has been automatically displayed in the text box. To restrict other LAN devices, click **Other MAC Address** radio button and enter the MAC address of the other LAN device.
4. Select the day to allow the rule to take effect in the table.
5. Enter the **Start Blocking Time** and **End Blocking Time** in the text box separately, and then the device controlled will then be unable to connect to the internet during that time.
6. Click **Save/Apply** to save this entry and then you will see your settings as shown in Figure 4-38.

Note:

The Time Restriction will not work correctly before the time of the device is set in “**Management** → **Internet Time**”.

4.4.7.2 URL Filter

This feature allows you to configure the filter rules based on URL to control all the computers in the LAN to access the specified port, and it is independent with Time Restriction feature.

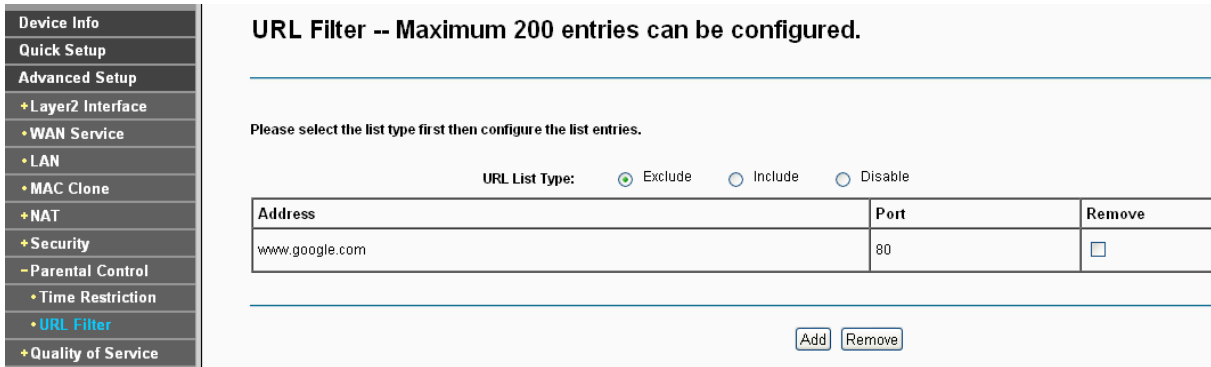

Figure 4-40

There are two policies for the URL Filter.

- **Exclude:** Block the PCs to access the specified URL.
- **Include:** Only allow the PCs to access the specified URL.
- **Disable:** URL Filter function will not take effect.

To add a URL Filter entry:

1. Check the **Exclude** or **Include** radio button. Here we take **Exclude** for example.
2. Click the **Add** button in Figure 4-40 and then you will see the next screen as shown in Figure 4-41. Enter the URL Address and Port Number.

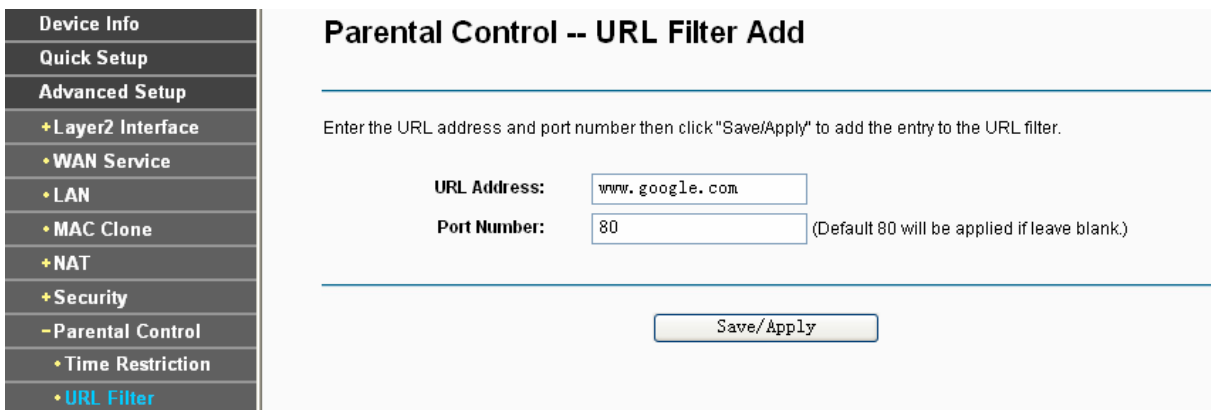

Figure 4-41

3. Click **Save/Apply** to save this entry and then you will see your settings as shown in Figure 4-40. Every computer connected to the router will not access this URL address on the port.

4.4.8 Quality of Service

Choose “**Advanced Setup**”→“**Quality of Service**”, you can enable QoS (Quality of Service) on the screen shown in Figure 4-42. QoS helps to prioritize data as it enters your router. By attaching special identification marks or headers to incoming packets, QoS determines which queue the packets enter, based priority. This is useful when there are certain types of data you want to give higher priority, such as voice data packets give higher priority than Web data packets. This option will provide better service of selected network traffic over various technologies.

Figure 4-42

Select the **Enable QoS** checkbox to enable all QoS for all interfaces.

Select a **Default DSCP make** from drop-down list to automatically mark incoming traffic without reference to a particular classifier.

Click **Save/Apply** to save the current configuration.

Note:

The default DSCP mark is used to mark all egress packets that do not match any classification rules.

4.4.8.1 Queue Config

Choose “**Advanced Setup**”→“**Quality of Service**”→“**Queue Config**”, you can set up virtual servers on the screen below.

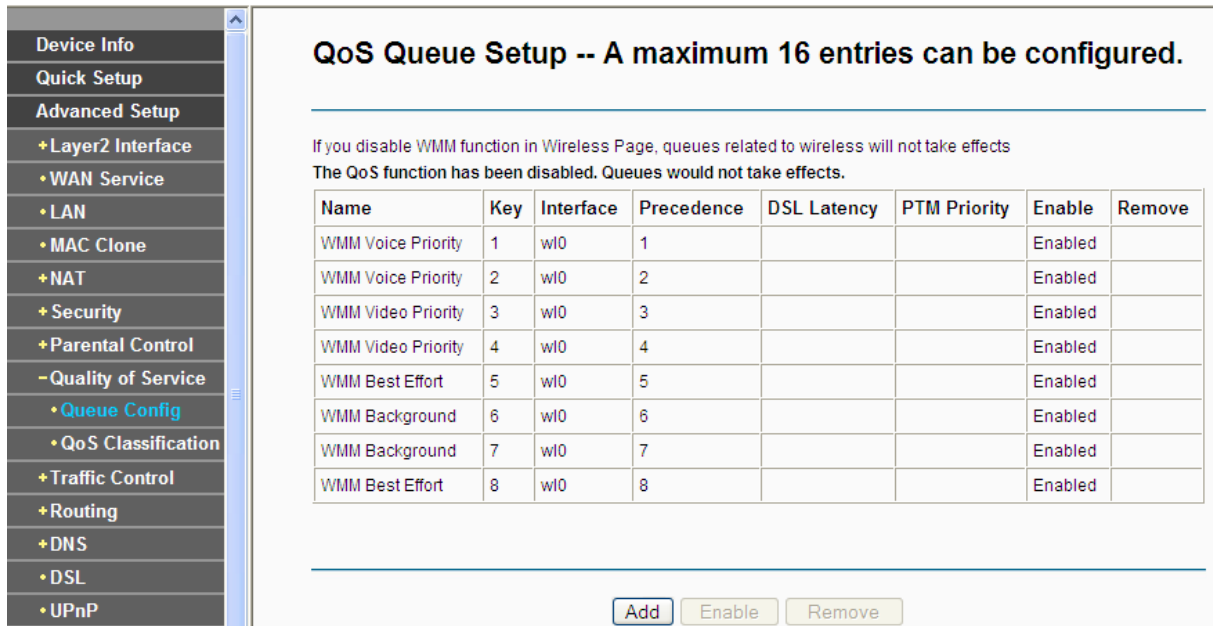

Figure 4-43

Click the **Add** button in Figure 4-43, and you can configure the QoS queue entry on the next screen as shown in Figure 4-44.

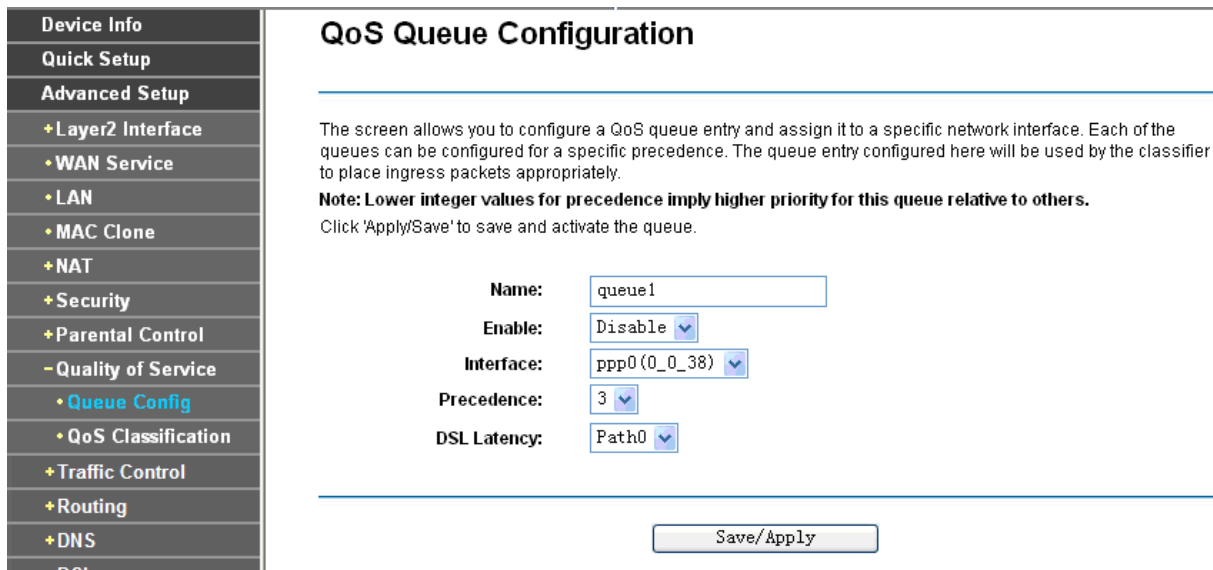

Figure 4-44

- **Name:** Set a name for the entry.
- **Enable:** Select Enable option to take this entry effect.
- **Interface:** Assigned a specific Wan Service for this QoS queue entry.
- **Precedence:** Specify precedence for this QoS queue entry.
- **DSL Latency:** Select latency path for the type of data transmission, only Path0 is available for this Router.

After you specify the condition, click **Save/Apply** to save the entry and then you will see you settings as shown in Figure 4-43.

Note:

- 1) Lower integer values for precedence imply higher priority for this queue relative to others.
- 2) The queue entry configured here will be used by the classifier to place ingress packets appropriately.

4.4.8.2 QoS Classification

This section will guide you to create a traffic class rule to classify the upstream traffic, assign queue which defines the precedence and the interface and optionally overwrite the IP header DSCP byte.

A rule consists of a class name and at least one condition below. All of the specified conditions in this classification rule must be satisfied for the rule to take effect.

QoS Classification Setup -- A maximum 32 entries can be configured.

Choose Add or Remove to configure network traffic classes.
If you disable WMM function in Wireless Page, classification related to wireless will not take effects

CLASSIFICATION CRITERIA														CLASSIFICATION RESULTS				
Class Name	Order	Class Intf	Ether Type	SrcMAC/ Mask	DstMAC/ Mask	SrcIP/ Mask	DstIP/ Mask	Proto	Src Port	Dst Port	DSCP Check	802.1P Check	Queue Key	DSCP Mark	802.1P Mark	VlanID Tag	Enable	Remove
fp-class	1				00:11:22:33:44:AA								34	AF12			<input checked="" type="checkbox"/>	<input type="checkbox"/>

Figure 4-45

Click the **Add** button Figure 4-45, and you can configure the QoS on the next screen.

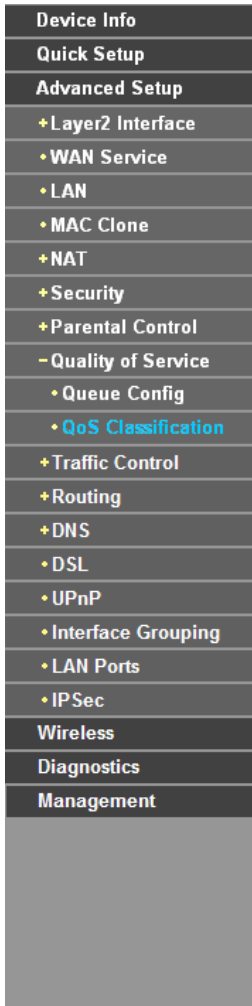

Add Network Traffic Class Rule

The screen creates a traffic class rule to classify the upstream traffic, assign queue which defines the precedence and the interface and optionally overwrite the IP header DSCP byte. A rule consists of a class name and at least one condition below. All of the specified conditions in this classification rule must be satisfied for the rule to take effect. Click 'Save/Apply' to save and activate the rule.

Traffic Class Name:
Rule Order:
Rule Status:

Specify Classification Criteria
 A blank criterion indicates it is not used for classification.
Class Interface:
Ether Type:
Source MAC Address:
Source MAC Mask:
Destination MAC Address:
Destination MAC Mask:

Specify Classification Results
 Must select a classification queue. A blank mark or tag value means no change.
Assign Classification Queue:
Mark Differentiated Service Code Point (DSCP):
Mark 802.1p priority:
Tag VLAN ID [0-4094]:

Figure 4-46

After you specify the condition, click **Save/Apply** to save the entry.

4.4.9 Traffic Control

Choose “**Advanced Setup**”→“**Traffic Control**” and then you will see the screen as shown in Figure 4-47. This page allows you to enable this function and to configure the value of Egress/Ingress Total Rate.

TC -- Traffic Control

The Egress/Ingress Total Rate must be configured here; otherwise TC rules can not be added. The recommended Ingress/Egress Total Rate is Line Upstream/Downstream Rate. Click 'Apply/Save' button to save it.
Note:
 If Enable checkbox is not selected, all TC rules will be deactivated.
 Make sure that Ingress/Egress Total Rate is not greater than Line Upstream/Downstream Rate, otherwise TC rules will not take effect.

Enable

Egress Total Rate (Kbps): **Line Rate - Upstream (Kbps):**
Ingress Total Rate(Kbps): **Line Rate - Downstream (Kbps):**

Figure 4-47

- **Enable:** Check this box to enable the Traffic Control function.
- **Egress Total Rate (Kbps):** Enter the upload speed through the WAN port.
- **Ingress Total Rate (Kbps):** Enter the download speed through the WAN port.
- **Line Rate-Upstream (Kbps):** This field displays the upload speed assigned by your ISP.
- **Line Rate-Downstream (Kbps):** This field displays the download speed assigned by your ISP.
- **Save/Apply:** Click this button to make the configuration take effect.

Note:

- 1) The Egress Total Rate and Ingress Total Rate are required to be configured. Otherwise TC rules cannot be added.
- 2) Only when the Router is configured to work in DSL connection does the Line Rate field display the upload/download speed assigned by your ISP. Otherwise there will be empty.

4.4.9.1 Traffic Control Rule

Choose “**Advanced Setup**”→“**Traffic Control**” →“**Traffic Control Rule**” and then you will see the screen as shown in Figure 4-48. This page allows you to view and configure TC rules.

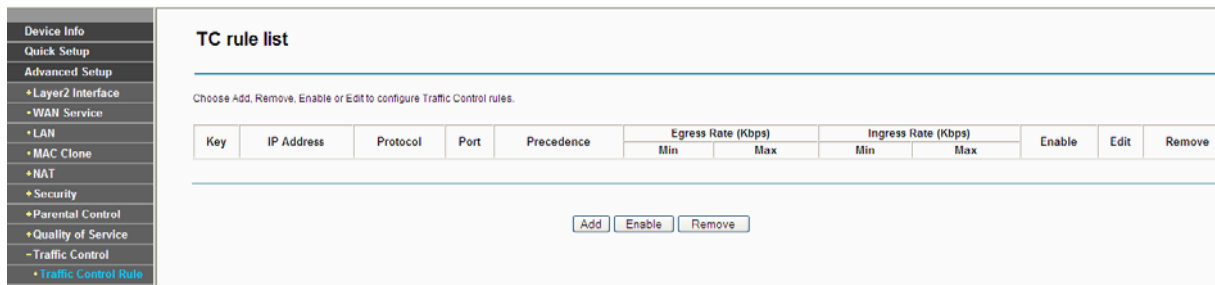

Figure 4-48

To add a TC rule, click the **Add** button and you can configure it in the screen as shown in Figure 4-49.

The screen allows you to configure a TC rule entry. Each of the rules can be configured for a specific precedence. The rule entry configured here will be used to control the rates of ingress and egress packets.

Note: Min Egress/Ingress Rates must not be empty and not less than 10 Kbps.
 Max Egress/Ingress Rate should not be greater than the Egress/Ingress Total Rate, if empty or greater than the Egress/Ingress Total Rate, the actual value will be set with Egress/Ingress Total Rate.
 Click 'Save/Apply' to save and activate the rule.

Rule Status:

IP Range: -

Port Range: -

Protocol:

Precedence:

	Min Rate (Kbps)	Max Rate (Kbps)
Egress Rate:	<input type="text" value="100"/>	<input type="text" value="200"/>
Ingress Rate:	<input type="text" value="400"/>	<input type="text" value="800"/>

Figure 4-49

- **Rule Status:** Select the status of the rule from the drop-down list to enable or disable the rule.
- **IP Range:** Enter a single IP address or a range of IP addresses.
- **Port Range:** Enter a single port or a range of ports.
- **Protocol:** Select a protocol type from the drop-down list. TCP, UDP and ALL are available here.
- **Precedence:** Select precedence from the drop-down list. There are five options: Highest, High, Medium, Low and Lowest. The default precedence of the rule is Medium.
- **Egress Rate:** Enter the min and max upload speed through the WAN port.
- **Ingress Rate:** Enter the min and max download speed through the WAN port.

After completing the above configuration, click the **Save/Apply** button to make it take effect and then you will see the following list as shown in Figure 4-50. If you want to modify the rule, click the **Edit** button. If you want to delete the rule, check the **Remove** box first and then click the **Remove** button.

TC rule list

Choose Add, Remove, Enable or Edit to configure Traffic Control rules.

Key	IP Address	Protocol	Port	Precedence	Egress Rate (Kbps)		Ingress Rate (Kbps)		Enable	Edit	Remove
					Min	Max	Min	Max			
1	192.168.1.101-192.168.1.103	TCP	80	Medium	100	200	400	1000	<input checked="" type="checkbox"/>	<input type="button" value="Edit"/>	<input type="checkbox"/>

Figure 4-50

Note:

The precedence, max egress/ingress rate and min egress/ingress rate work on allocation of surplus upload/download bandwidth. For rules with different precedence, the surplus bandwidth is firstly allocated to the rule with the highest precedence according to its max egress/ingress rate. If

there still has surplus bandwidth, it is allocated to the rule with hypo-high precedence. For rules with the same precedence, the surplus bandwidth is allocated to them according to their min egress/ingress rate. The greater a rule's min egress/ingress rate is, the more bandwidth it gets.

4.4.10 Routing

Choose “**Advanced Setup**”→“**Routing**”, it includes three menus: **Default Gateway**, **Static Route and RIP** (shown in Figure 4-51). The detailed descriptions are provided below.

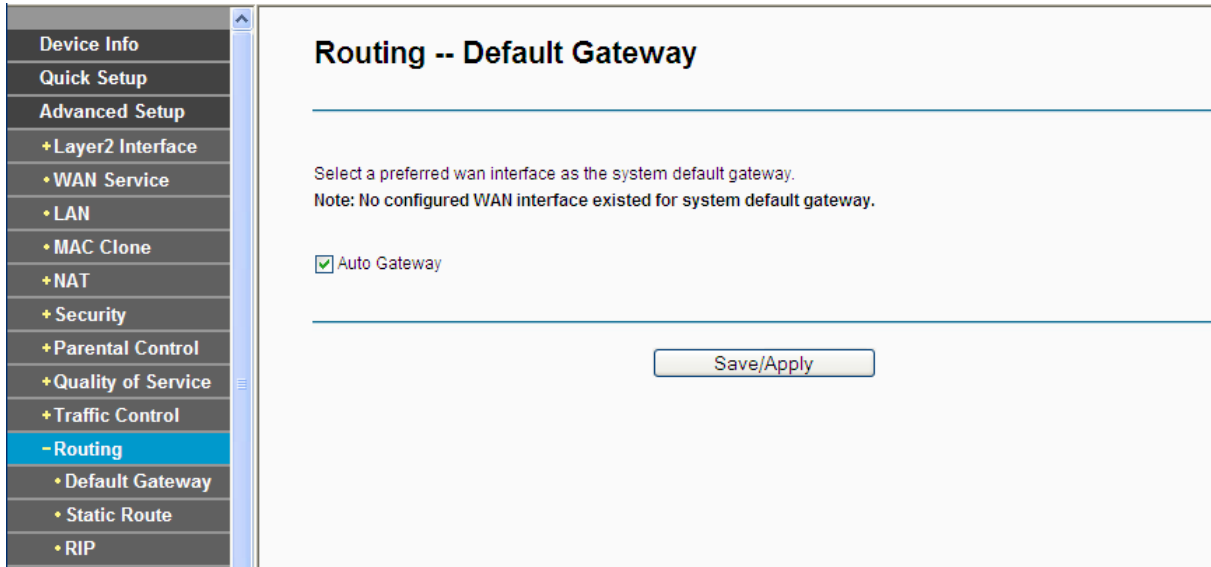

Figure 4-51

4.4.10.1 Default Gateway

Choose “**Advanced Setup**”→“**Routing**”→“**Default Gateway**”, you can see the Default Gateway screen. Deselect the checkbox before **Auto Gateway**, and then you will be able to select a WAN Interface from the drop-down list as the system default gateway. The **Auto Gateway** checkbox is selected by default.

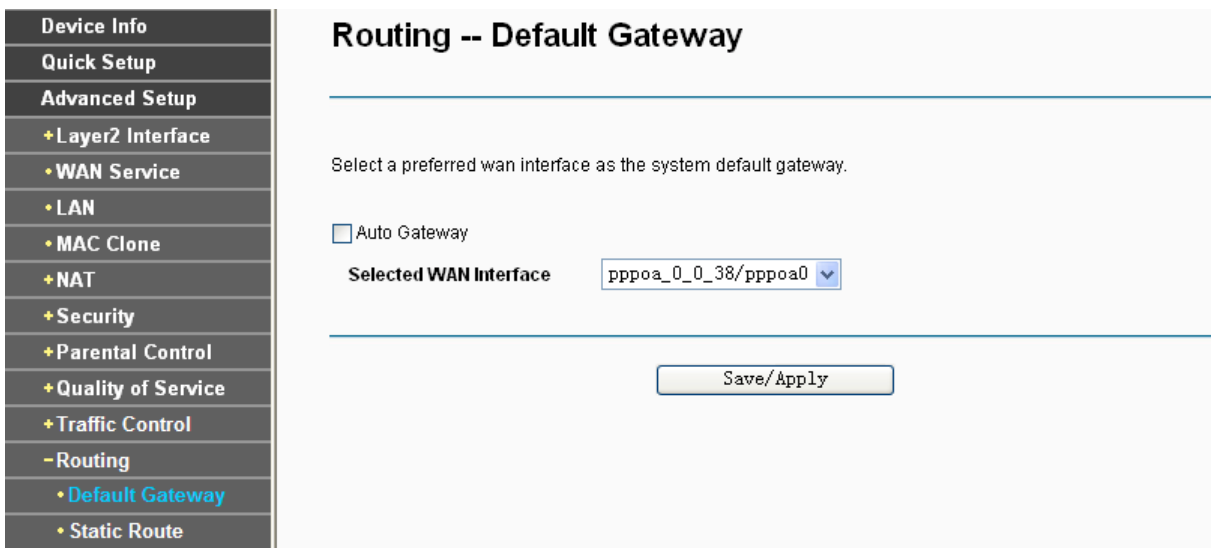

Figure 4-52

Note:

- 1) If changing the Automatic Assigned Default Gateway from unselected to selected, you have to reboot the Router to get the automatically assigned default gateway.
- 2) Default Gateway IP address should be specified since MER Interface is selected when you select the **Enable automatic Assigned Default Gateway** check box.

4.4.10.2 Static Route

Choose **“Advanced Setup”**→**“Routing”**→**“Static Route”**. You can see the Static Route screen, this screen allows you to configure the static routes (shown in Figure 4-53). A static route is a pre-determined path that network information must travel to reach a specific host or network.

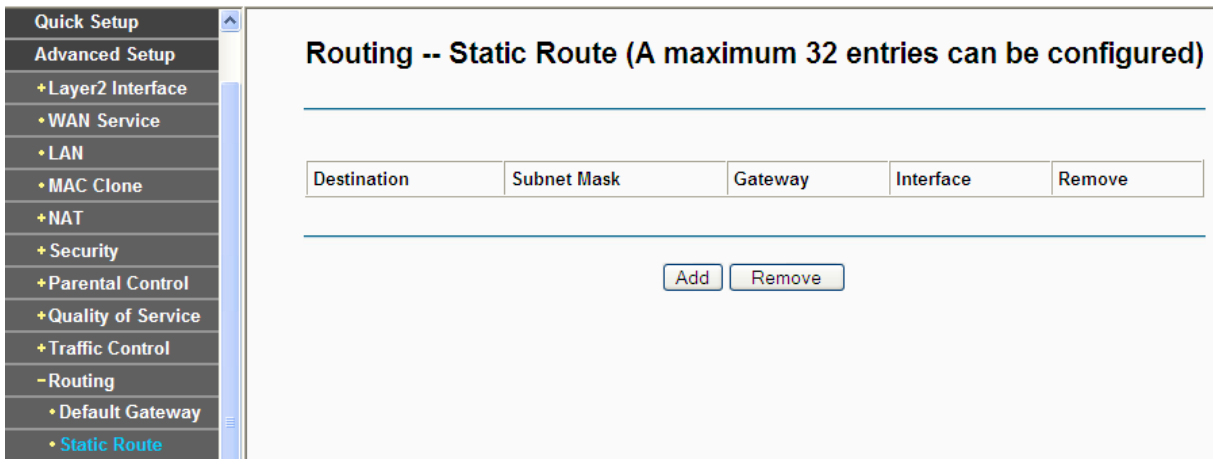

Figure 4-53

To add static routing entries:

1. Click the **Add** button in Figure 4-53, and you will see the screen as shown in Figure 4-54.

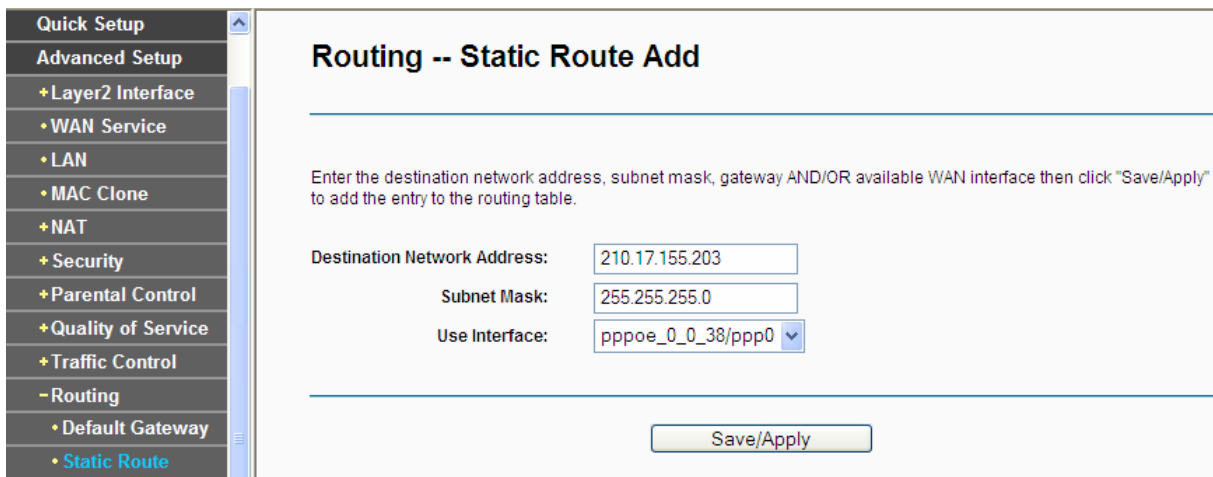

Figure 4-54

2. Enter the following data:
 - **Destination Network Address:** The **Destination Network Address** is the address of the network or host that you want to assign to a static route.
 - **Subnet Mask:** The **Subnet Mask** determines which portion of an IP Address is the network portion, and which portion is the host portion.

- **Use Interface:** Select the Interface name in the text box, or else, the default Use Interface will be adopted for the Static Route.
 - **Use Gateway IP Address:** If you select the IPoE or IPoA mode for **Use Interface**, the screen above will display this item, you should type the Gateway address correctly, and the other option for **Use Interface** will adopt the default Gateway address for the Static Route.
3. Click **Save/Apply** to and then you will see you settings as shown in Figure 4-53.

To remove a static routing entry:

1. Select the **Remove** check box according to the entry in the Figure 4-53.
2. Click the **Remove** button, and the entry will be deleted.

Note:

Gateway IP address should be correctly configured if IP based Interface (IPoE, IPoA) is selected.

4.4.10.3 RIP

Choose “**Advanced Setup**”→“**Routing**”→“**RIP**”, you can see the RIP (Routing Information Protocol) screen which allows you to configure the RIP (shown in Figure 4-55).

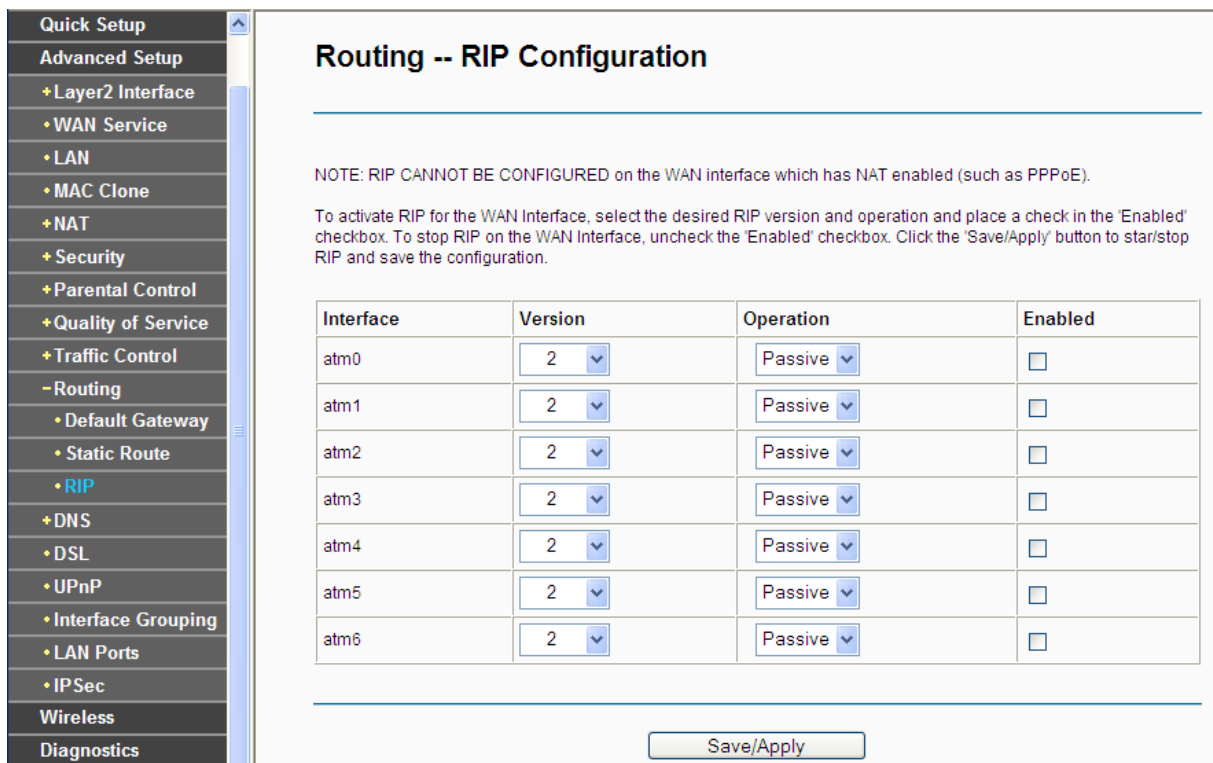

Figure 4-55

Note:

RIP cannot be configured on the WAN Interface which has NAT enabled (such as PPPoE).

To activate RIP for the device, configure an individual interface, select the desired RIP version and operation, and select **Enabled** checkbox for the interface.

Click **Save/Apply** to save the configuration.

4.4.11 DNS

When you select the connection type **PPPoE**, **PPPoA** or **IPoA** for WAN configuration, you will see the **DNS** menu in the Web-based Utility (shown in Figure 4-56). It includes **DNS Server** and **Dynamic DNS** submenus.

DNS Server Configuration

Select the configured WAN interface for DNS server information OR enter the static DNS server IP Addresses for single PVC with IPoA, static IPoE protocol.

Auto DNS Server

Apply/Save

Figure 4-56

4.4.11.1 DNS Server

Choose “**Advanced Setup**”→“**DNS**”→“**DNS Server**”, and you can see the **DNS Server Configuration** screen. Deselect the checkbox before **Auto DNS Server**, and then you will be able to manually configure the DNS Server Addresses as shown in Figure 4-57.

DNS Server Configuration

Select the configured WAN interface for DNS server information OR enter the static DNS server IP Addresses for single PVC with IPoA, static IPoE protocol.

Auto DNS Server

Obtain DNS info from a WAN interface:
WAN Interface selected:

Use the following Static DNS IP address:
Primary DNS server:
Secondary DNS server:

Apply/Save

Figure 4-57

For PPPoA, PPPoE enabled PVC(s), please select the **Obtain DNS info from a WAN interface** checkbox, this Router will accept automatically the first received DNS assignment from the selected configured WAN interface during the connection establishment.

For single PVC with IPoA, static IPoE protocol, please select the **Use the following Static DNS IP address** checkbox, and enter the primary and /or optional secondary DNS server IP addresses provided by your ISP.

Click the **Apply/Save** button to save the new configuration.

4.4.11.2 Dynamic DNS

Choose “**Advanced Setup**”→“**DNS**”→“**Dynamic DNS**”, you can see the **Dynamic DNS** screen, this screen allows you to configure the Dynamic DNS (shown in Figure 4-58).

The Router offers a Dynamic Domain Name System (**DDNS**) feature. DDNS lets you assign a fixed host and domain name to a dynamic Internet IP Address. The Dynamic DNS service allows you to alias a dynamic IP address to a static hostname in any of the many domains, allowing your Router to be more easily accessed from various locations on the Internet.

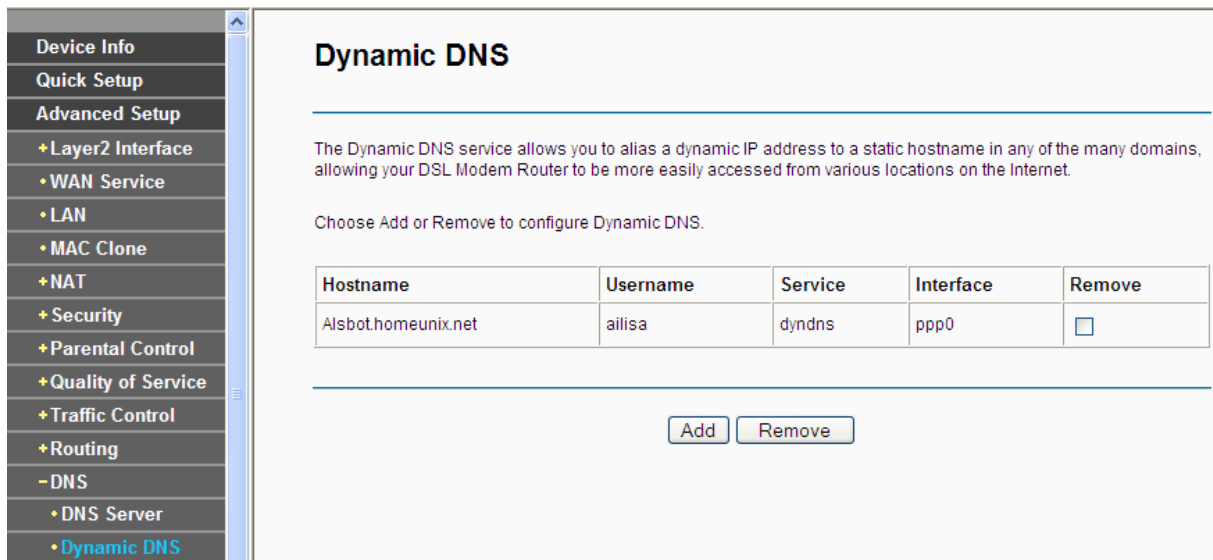

Figure 4-58

To add a DDNS entry:

1. Click the **Add** button (pop-up Figure 4-58), and then you will set the DDNS in the next screen (shown in Figure 4-59).

Figure 4-59

2. Select **D-DNS provider** in the drop-down list.
3. Enter the **Hostname** of the DNS Server, and select the corresponding **Interface** for the DDNS, you can leave it default.
4. Type the **User Name** and **Password** for your DDNS account.
5. Click **Save/Apply** to save the entry and then you will see your settings as shown in Figure 4-58.

4.4.12 DSL

Choose “**Advanced Setup**”→“**DSL**”, you can see the DSL Settings screen, this screen allows you to configure the DSL (shown in Figure 4-60).

DSL Settings

Select the modulation below

- G.Dmt Enabled
- G.lite Enabled
- T1.413 Enabled
- ADSL2 Enabled
- AnnexL Enabled
- ADSL2+ Enabled
- AnnexM Enabled

Select the phone line pair below

- Inner pair
- Outer pair

Capability

- Bitswap Enable
- SRA Enable

Save/Apply Advanced Settings

Figure 4-60

You can select the modulation type, phone line pair and the capability of Bitswap or SRA. After you set them up, click **Save/Apply** to save the configurations.

4.4.13 UPnP

Choose “**Advanced Setup**”→“**UPnP**”, you can Enable or Disable the UPnP (Universal Plug and Play) protocol on the screen.

UPnP (Universal Plug and Play) is a distributed, open networking standard that uses TCP/IP for simple peer-to-peer network connectivity between devices. An UPnP device can dynamically join a network, obtain an IP address, convey its capabilities and learn about other devices on the network. In turn, a device can leave a network smoothly and automatically when it is no longer in use. UPnP broadcasts are only allowed on the LAN.

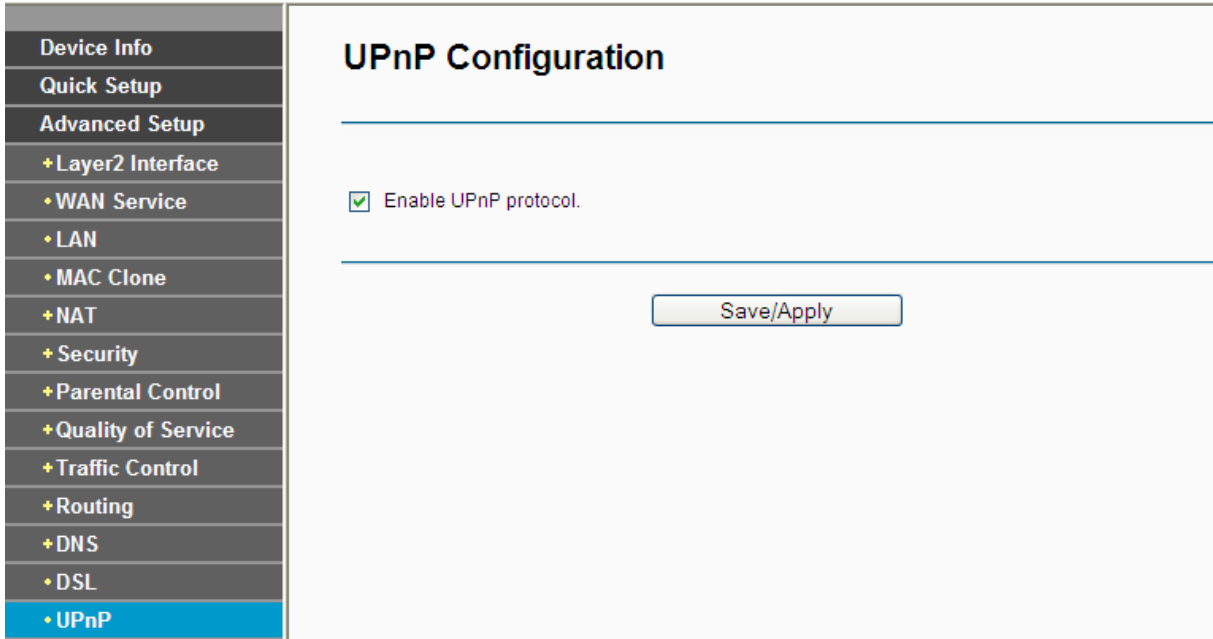

Figure 4-61

Select the checkbox and click **Save/Apply** to enable the UPnP function.

4.4.14 Interface Grouping

Choose “**Advanced Setup**”→“**Interface Grouping**”, you can configure multiple ports to PVC and bridging groups to perform as an independent network.

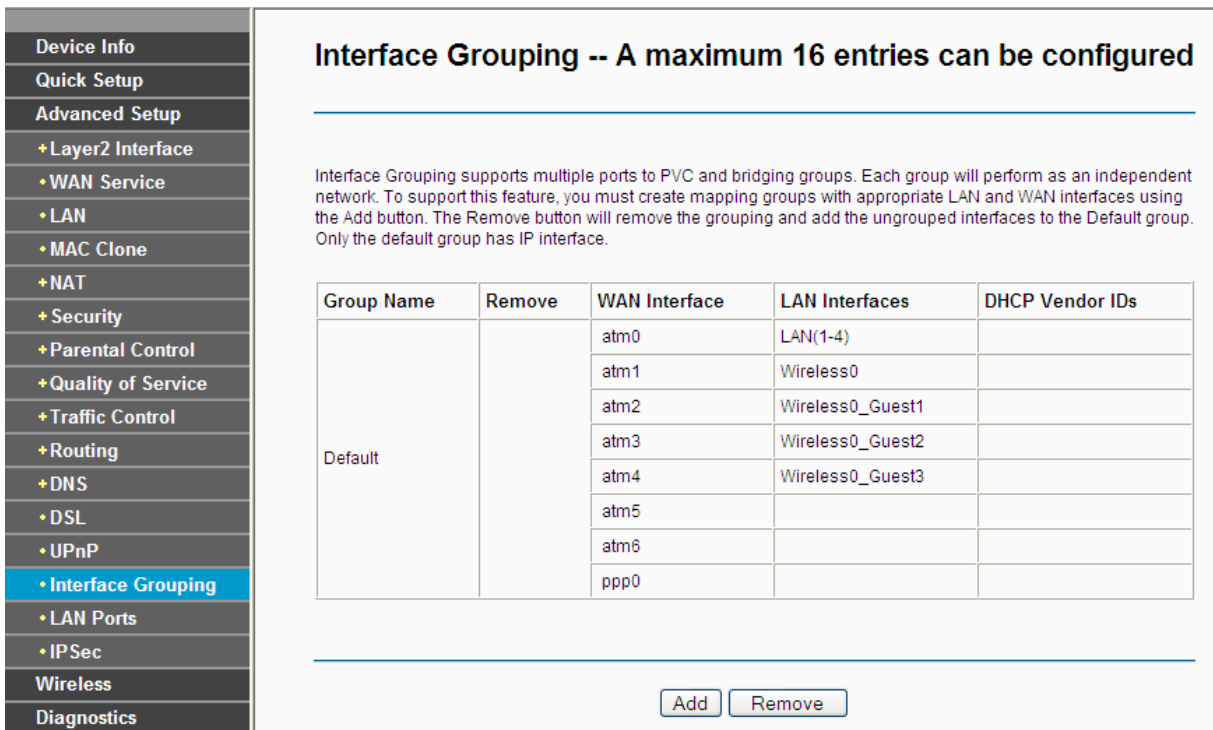

Figure 4-62

To support this feature, you must create mapping groups with appropriate LAN and WAN interfaces using the **Add** button. The **Remove** button will remove the grouping and add the ungrouped interfaces to the Default group. Only the default group has IP interface.

To create a new interface group:

1. Click the **Add** button. You can add a new interface group in the next screen.

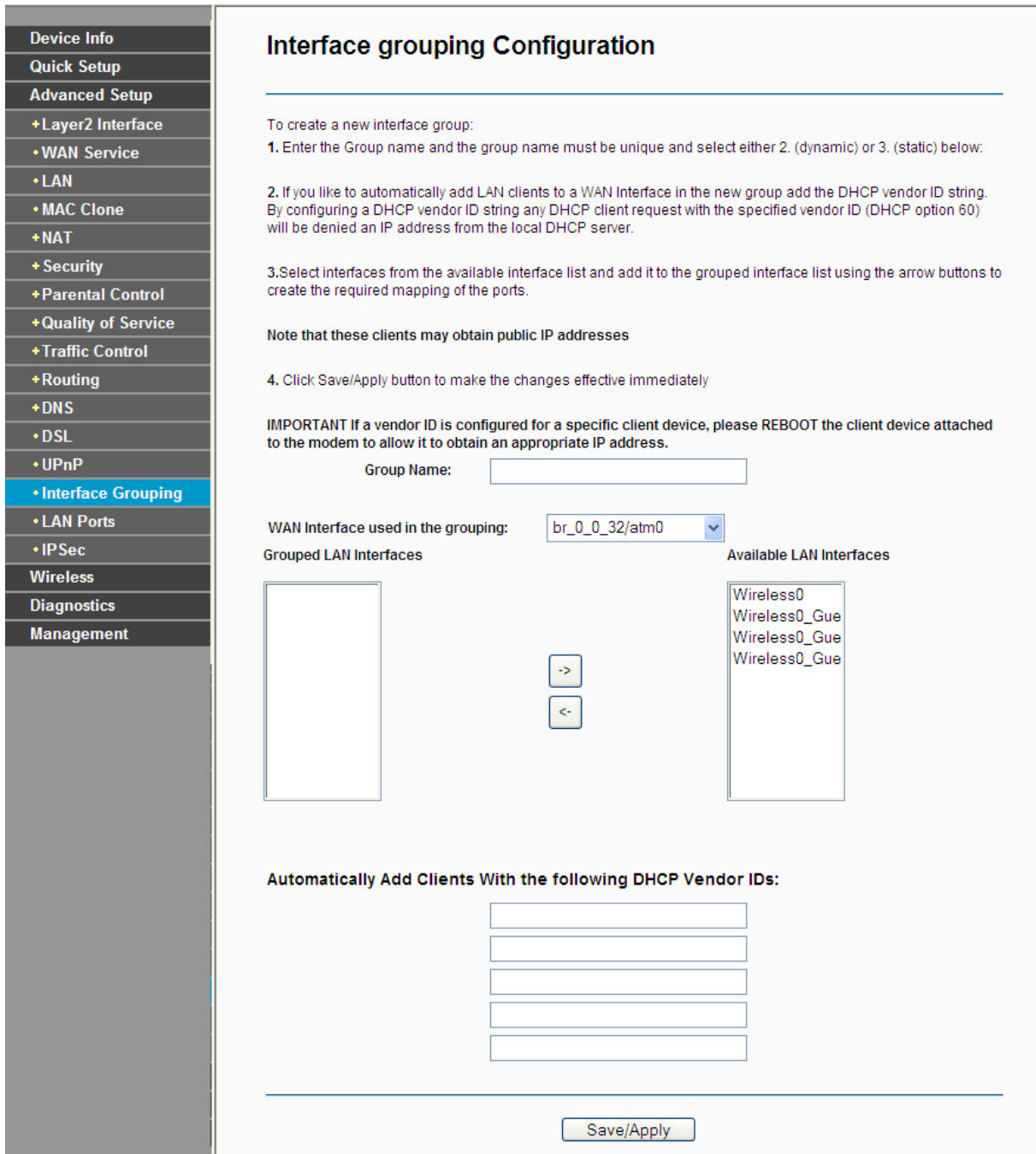

Figure 4-63

2. Enter a unique name for Group.
3. Select the Interface which you want to use from the drop-down list.

Note:

If you like to automatically add LAN clients to a WAN Interface in the new group add the DHCP vendor ID string. By configuring a DHCP vendor ID string any DHCP client request with the specified vendor ID (DHCP option 60) will be denied an IP address from the local DHCP server.

- Select interfaces from the available interface list and add it to the grouped interface list using the arrow buttons to create the required mapping of the ports.

Note:

These clients may obtain public IP addresses.

- Click **Save/Apply** to make the entry effective immediately.

Note:

If a vendor ID is configured for a specific client device, please REBOOT the client device attached to the modem to allow it to obtain an appropriate IP address.

4.4.15 LAN Ports

Choose “**Advanced Setup**”→“**LAN Ports**”, you can Enable/Disable the Virtual LAN Ports feature by selecting the checkbox on the screen.

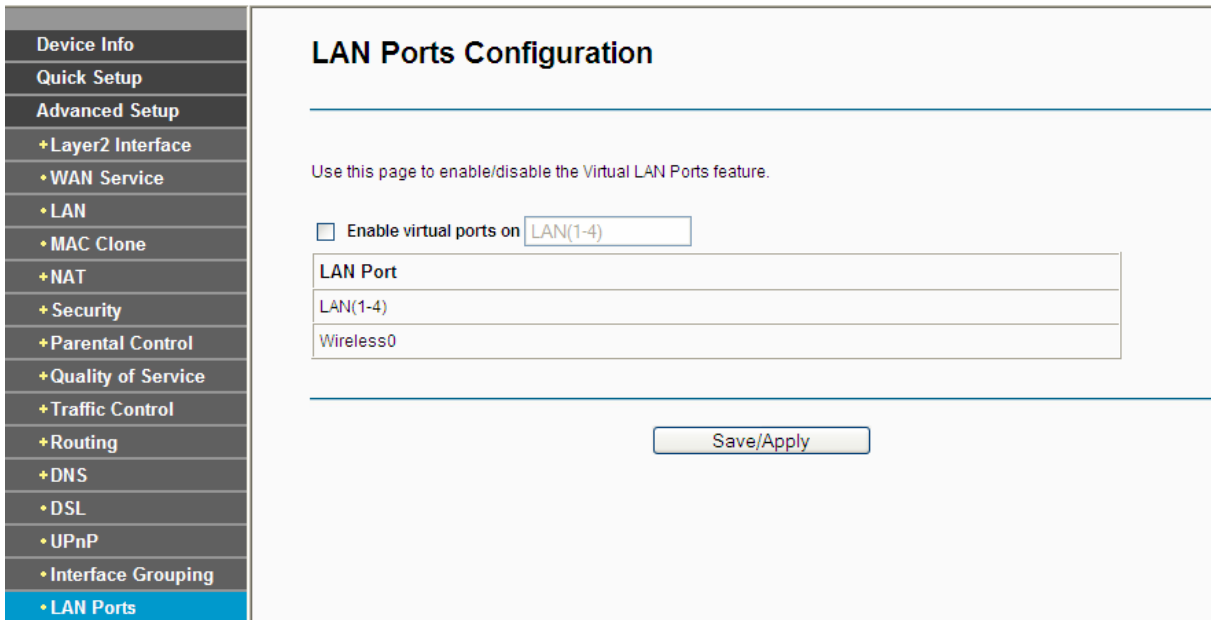

Figure 4-64

4.4.16 IPSec

Choose “**Advanced Setup**”→“**IPSec**”, you can Add/Remove or Enable/Disable the IPSec tunnel connections on the screen as shown in Figure 4-65.

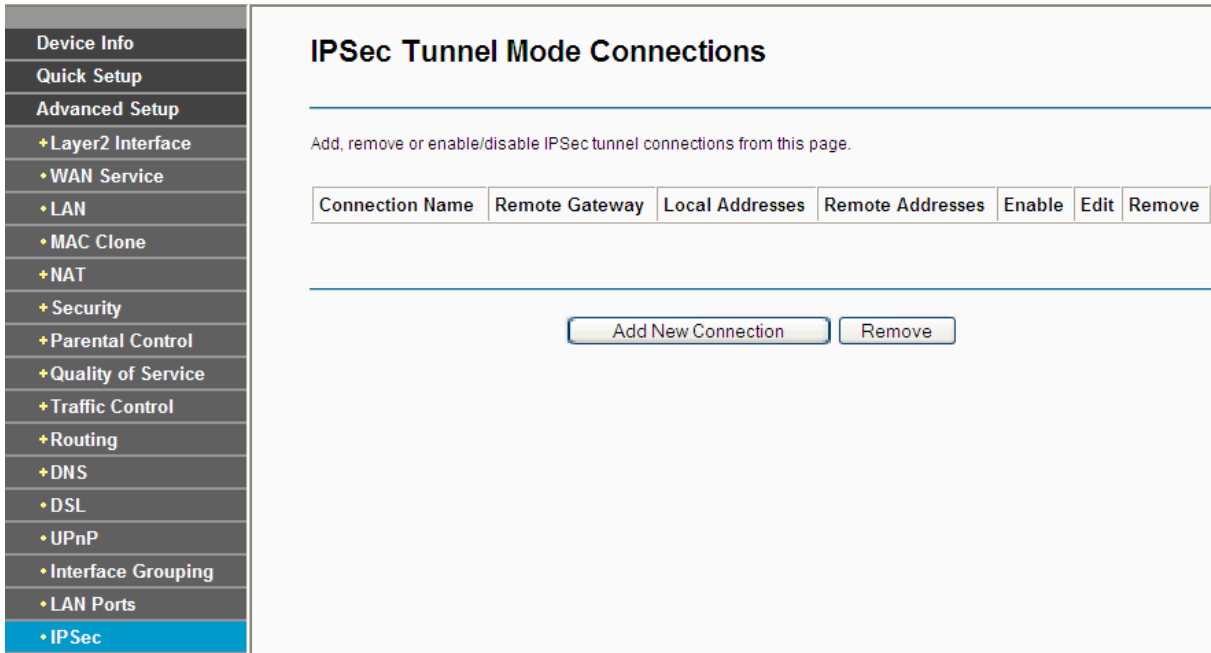
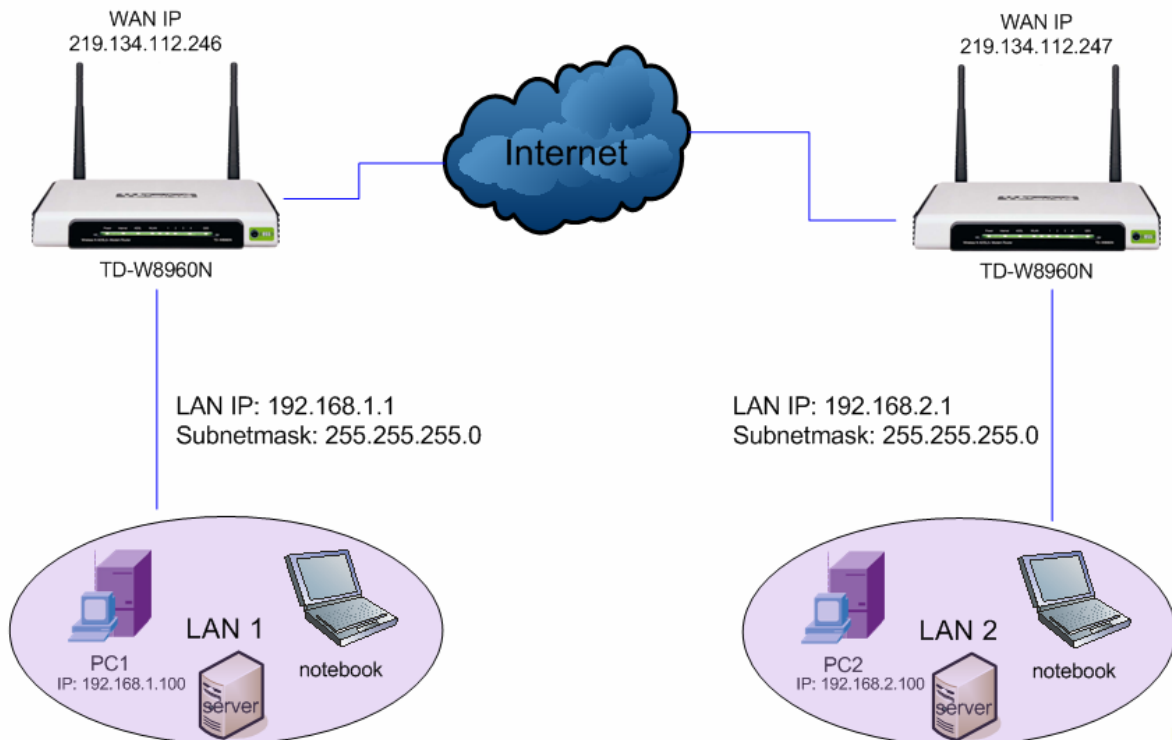

Figure 4-65

This section will guide you to configure a VPN tunnel between two TD-W8960Ns. The topology is as follows.



Note:

You could also use other VPN Routers to set VPN tunnels with TD-W8960N. TD-W8960N supports up to 10 VPN tunnels simultaneously.

Click **Add New Connection** in Figure 4-65 and then you will enter the screen shown in Figure 4-66.

Figure 4-66

- **IPsec Connection Name:** Enter a name for your VPN.
- **Remote IPsec Gateway Address (IP or Domain Name):** Enter the destination gateway IP address in the box which is the public WAN IP or Domain Name of the remote VPN server endpoint. (For example: Input **219.134.112.247** in **Device1**, Input **219.134.112.246** in **Device 2**)
- **Tunnel access from local IP addresses:** Choose Subnet if you want the Whole LAN to join the VPN network, or else choose Single Address if you want single IP to join the VPN network.
- **IP Address for VPN:** Enter the IP address of your LAN. (For example: Input **192.168.1.1** in **Device1**, Input **192.168.2.1** in **Device2**)
- **IP Subnetmask:** Enter the Subnet mask of your LAN. (For example: Input **255.255.255.0** in both **Device1** and **Device2**)
- **Tunnel access from remote IP addresses:** Choose Subnet if you want the Remote Whole LAN to join the VPN network, or else choose Single Address if you want single IP to join the VPN network.
- **IP Address for VPN:** Enter the IP address of the Remote LAN. (For example: Input **192.168.2.1** in **Device1**,Input **192.168.1.1** in **Device2**)
- **IP Subnetmask:** Enter the subnetmask of the remote LAN. (For example: Input **255.255.255.0** in both **Device1** and **Device2**)
- **Key Exchange Method:** Select Auto (IKE) or Manual.
- **Authentication Method:** Select Pre-Shared Key (recommended) or Certificate (X.509).

- **Pre-Shared Key:** Input the Pre-Shared key for Authentication. (For example: Input 12345678)
- **Perfect Forward Secrecy:** PFS is an additional security protocol.

We recommend you leave the Advanced Settings as default value.

After complete the basic settings and click Save/Apply in both **Device1** and **Device2**, PCs in LAN1 could communicate with PCs in remote LAN2. (For example: You can ping the IP address of PC2 which is 192.168.2.100 in PC1)

Note:

The VPN Servers Endpoint from both ends must use the same pre-shared keys and Perfect Forward Secrecy settings.

Click **Show Advanced Settings** and then you can configure the Advanced Settings.

Advanced IKE Settings: Hide Advanced Settings

Phase 1

Mode: Main

My Identifier Type: Local Wan IP

My Identifier:

Remote Identifier Type: Remote Wan IP

Remote Identifier:

Encryption Algorithm: 3DES

Integrity Algorithm: MD5

Select Diffie-Hellman Group for Key Exchange: 1024bit

Key Life Time: Seconds

Phase 2

Encryption Algorithm: 3DES

Integrity Algorithm: MD5

Select Diffie-Hellman Group for Key Exchange: 1024bit

Key Life Time: Seconds

Save/Apply

- **Main Mode:** Select Main Mode to configure the standard negotiation parameters for IKE phase1.
- **Aggressive Mode:** Select Aggressive Mode to configure IKE phase1 of the VPN Tunnel to carry out negotiation in a shorter amount of time. (Not Recommended-Less Secure)

Note:

The difference between the two is that aggressive mode will pass more information in fewer packets, with the benefit of slightly faster connection establishment, at the cost of transmitting the identities of the security firewall in the clear. When using aggressive mode, some configuration parameters such as Diffie-Hellman groups, and PFS can not be negotiated, resulting in a greater importance of having "compatible" configuration on both ends.

➤ **Key Life Time:**

Enter the number of seconds for the IPSec lifetime. It is the period of time to pass before establishing a new IPSec security association (SA) with the remote endpoint. The default value is 3600.

 **Note:**

If you want to change the default settings of **Advanced Settings**, please make sure that both VPN server endpoints use the same Encryption Algorithm, Integrity Algorithm, Diffie-Hellman Group and Key Life time in both **phase1** and **phase2**.

4.5 Wireless

Choose “**Wireless**”, there are six submenus to configure Wireless LAN settings. Click any of them, and you will be able to configure the corresponding function. The detailed explanations for each submenu are provided below.



4.5.1 Basic

Choose “**Wireless**”→”**Basic**”, you will see the screen of **Wireless--Basic** settings shown as below. The basic settings for wireless networking are set on this screen.

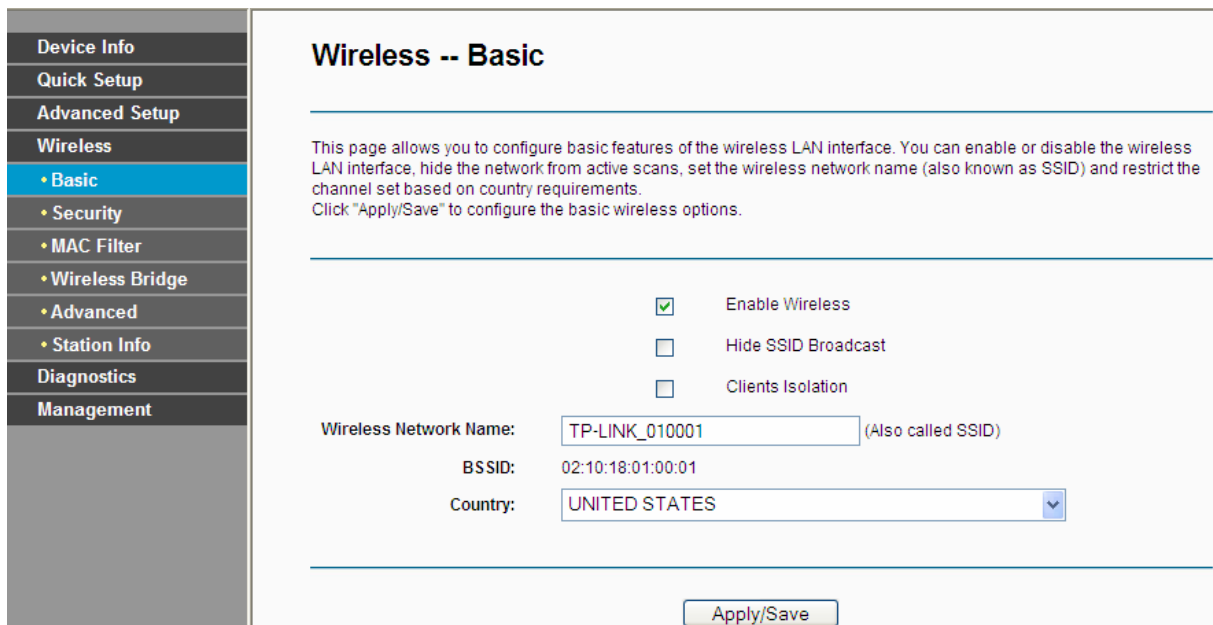

Figure 4-67

This page allows you to configure basic features of the wireless LAN interface. You can enable or disable the wireless LAN interface, hide the network from active scans, set the wireless network name (also known as SSID) and restrict the channel set based on Region requirements.

- **Enable Wireless:** If you want to use wireless features, you must select “Enable Wireless”. If you deselect “Enable Wireless” option, all the Wireless settings below will be disabled.
- **Hide Access Point:** When wireless clients survey the local area for wireless networks to associate with, you can select this option to avoid being surveyed.
- **Clients Isolation:** Select this option to enable AP isolation function so that stations associated to the AP will not be able to communicate with each other.
- **SSID:** Wireless network name shared among all points in a wireless network. The SSID must be identical for all devices in the wireless network. It is case-sensitive and must not exceed 32 characters (use any of the characters on the keyboard). Make sure this setting is the same for all stations in your wireless network. Type the desired SSID in the space provided.
- **BSSID:** Show the MAC address of the Router.
- **Country:** Restrict the channel set and transmit power.

Click **Apply/Save** to save your settings.

4.5.2 Security

Choose “**Wireless**” → “**Security**”, you will see the screen of **Wireless--Security** settings shown as below. You can configure security features of the wireless LAN interface by manually setting the network authentication or through QSS (Quick Security Setup) method.

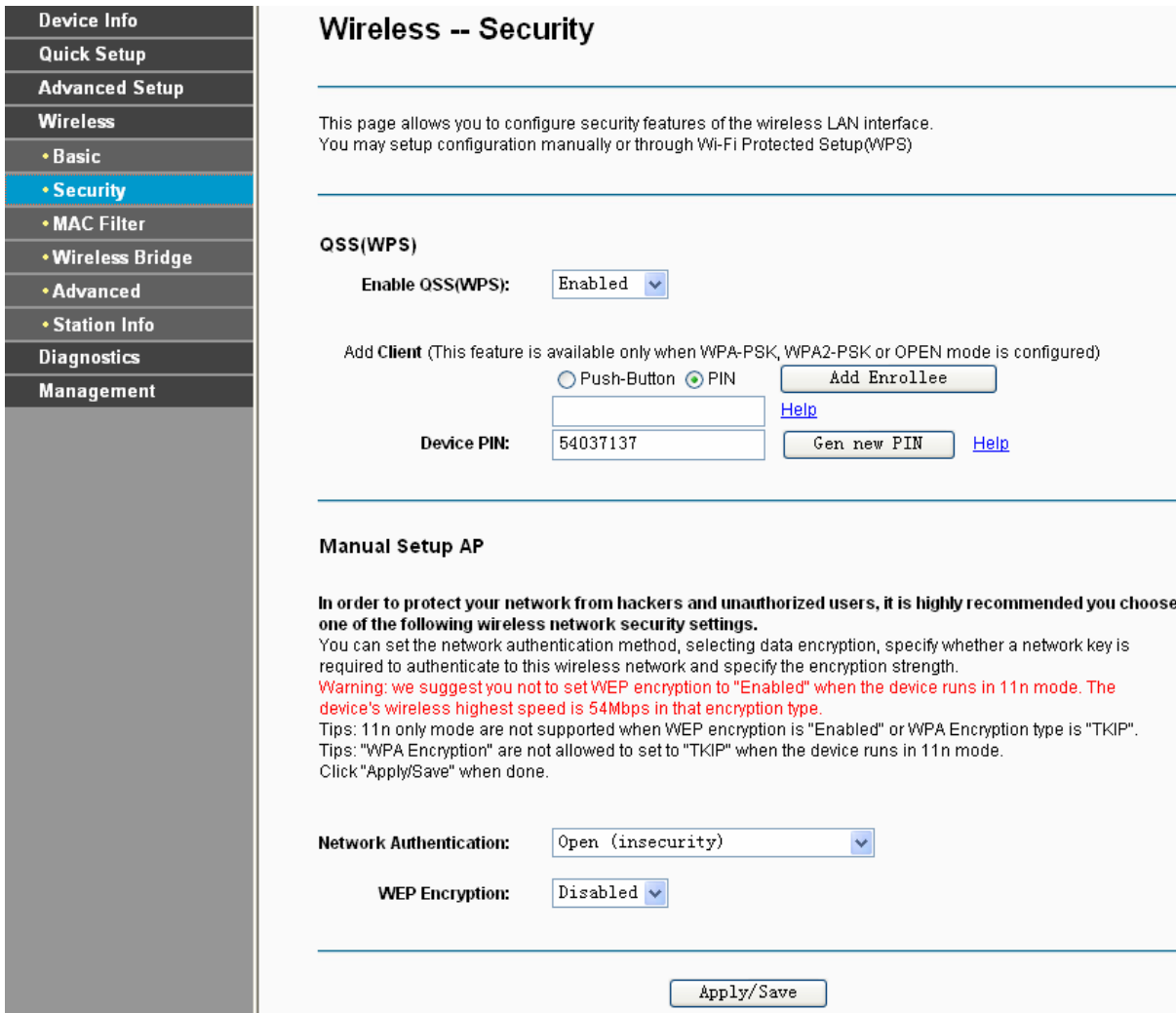

Figure 4-68

4.5.2.1 QSS (WPS) Setup

[Back to LED Explanation](#)

This section will guide you to add a new wireless device to an existing network quickly by **QSS** (Quick Security Setup) method. It's also called WPS (Wi-Fi Protected Setup) in some cases.

Note:

- 1) This feature is available only when OPEN, WPA-PSK, WPA2-PSK or Mixed WPA2/WPA-PSK mode is configured.
- 2) To build a successful connection by QSS, you should also do the corresponding configuration of the new device for QSS function meanwhile.
- 3) QSS (Quick Security Setup) is one kind of WPS (Wi-Fi Protected Setup) method.

I. By PBC

If the wireless adapter supports Quick Security Setup and the Push Button Configuration (PBC) method, you can add it to the network by PBC with the following two methods. Click **Push-Button**, you will see the screen as shown below.

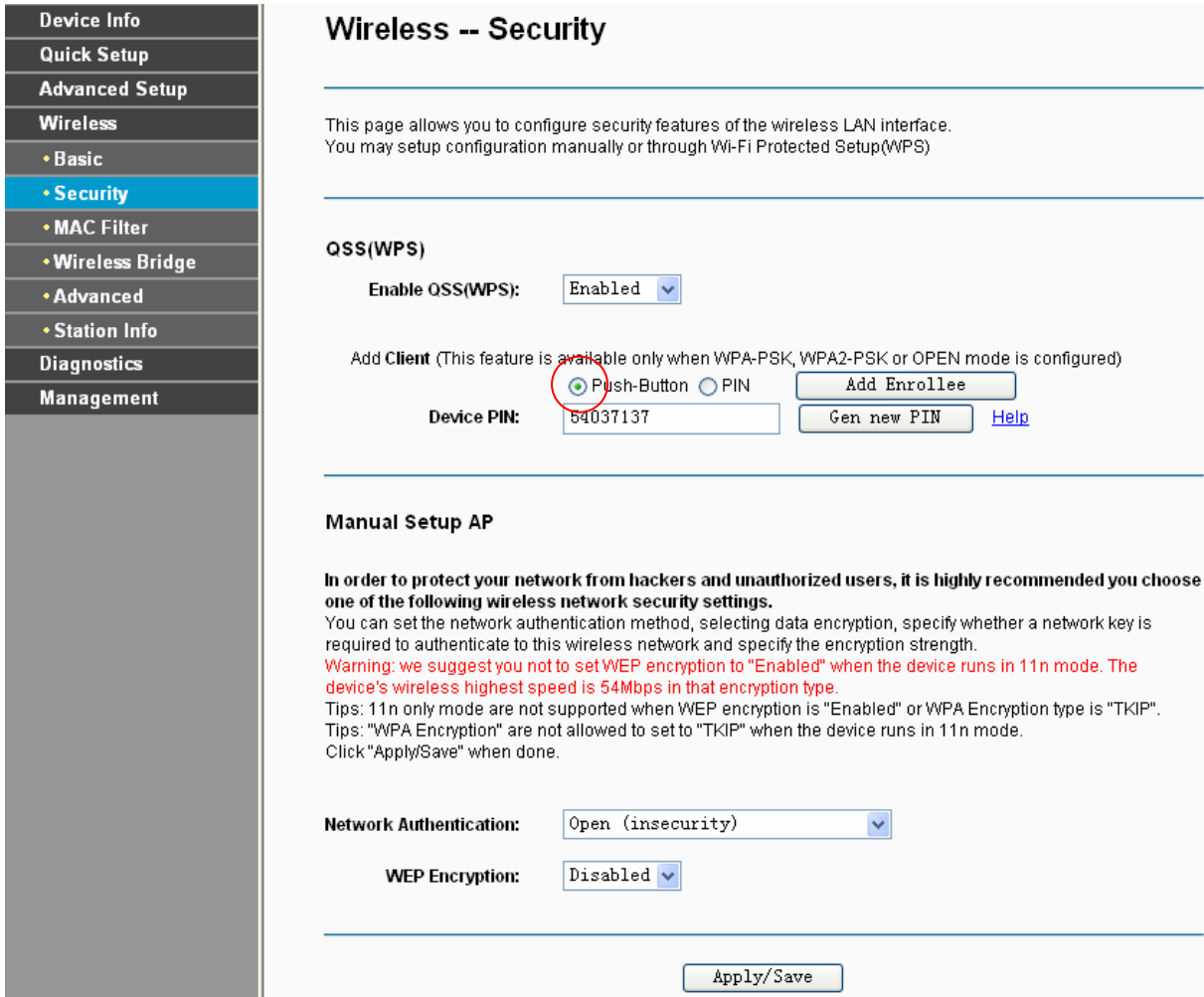
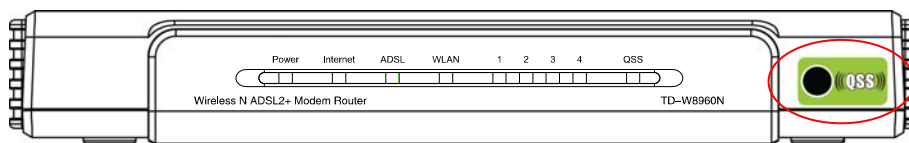

Figure 4-69

Method One: Hardware push button.

Step 1: Press the QSS button on the front panel of the Router.



Step 2: Press and hold the QSS button of the adapter directly for 2 or 3 seconds.



Step 3: Wait for a while until the next screen of adapter appears. Click **Finish** to complete the QSS configuration.

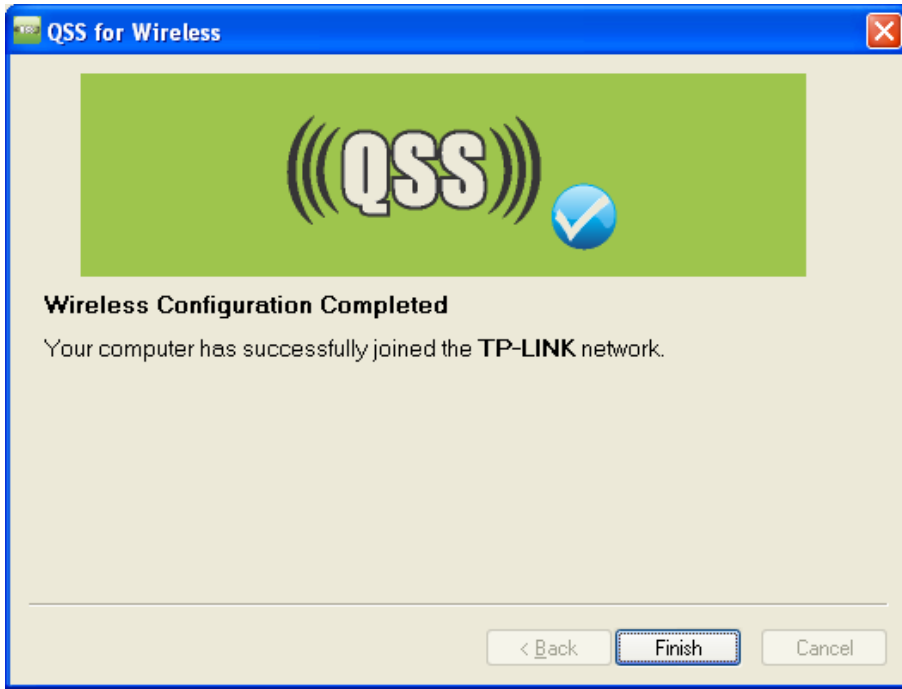
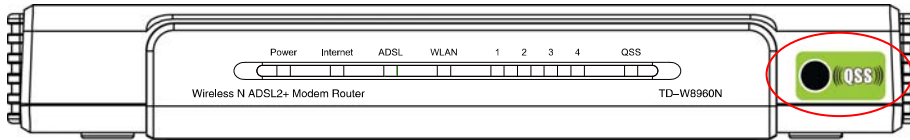

Figure 4-70

Method Two:

Step 1: Press the QSS button on the front panel of the Router.



Step 2: For the configuration of the wireless adapter, please choose “**Push the button on my access point**” in the configuration utility of the QSS as below, and click **Next**.

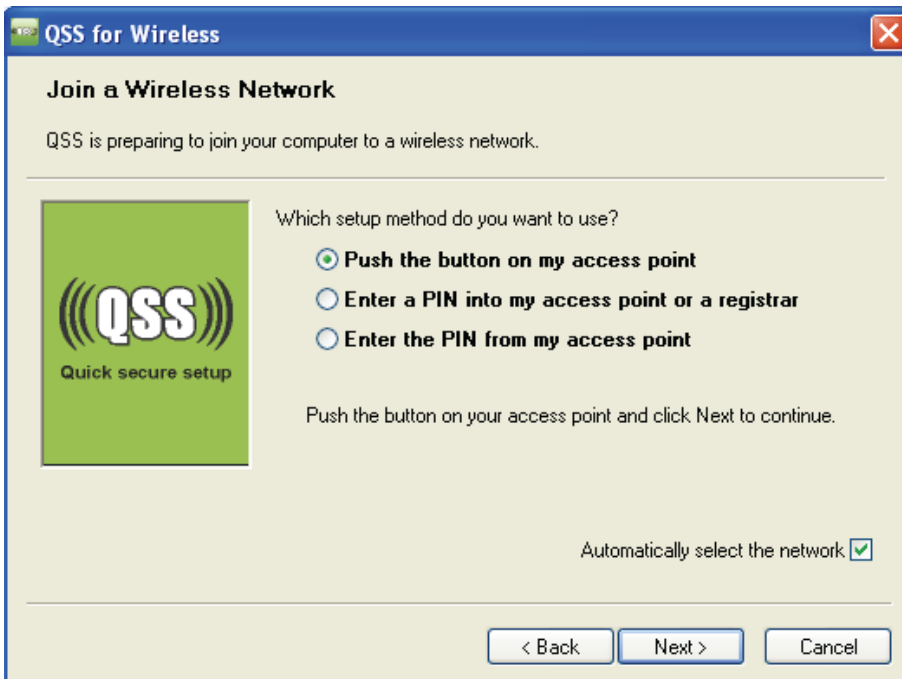

Figure 4-71

Step 3: Wait for a while until the next screen appears. Click **Finish** to complete the QSS configuration.



Figure 4-72

II. By PIN

If the new device supports Quick Security Setup and the PIN method, you can add it to the network by PIN with the following two methods.

Method One: Enter the PIN of wireless adapter into my Router.

Step 1: Select the **PIN** checkbox and enter the PIN code of the wireless adapter in the field under as shown below. Then click **Add Enrollee**.

- Device Info
- Quick Setup
- Advanced Setup
- Wireless
 - Basic
 - **Security**
 - MAC Filter
 - Wireless Bridge
 - Advanced
 - Station Info
- Diagnostics
- Management

Wireless -- Security

This page allows you to configure security features of the wireless LAN interface. You may setup configuration manually or through Wi-Fi Protected Setup(WPS)

QSS(WPS)

Enable QSS(WPS):

Add Client (This feature is available only when WPA-PSK, WPA2-PSK or OPEN mode is configured)

Push-Button
 PIN

Device PIN:

Manual Setup AP

In order to protect your network from hackers and unauthorized users, it is highly recommended you choose one of the following wireless network security settings.

You can set the network authentication method, selecting data encryption, specify whether a network key is required to authenticate to this wireless network and specify the encryption strength.

Warning: we suggest you not to set WEP encryption to "Enabled" when the device runs in 11n mode. The device's wireless highest speed is 54Mbps in that encryption type.

Tips: 11n only mode are not supported when WEP encryption is "Enabled" or WPA Encryption type is "TKIP".
 Tips: "WPA Encryption" are not allowed to set to "TKIP" when the device runs in 11n mode.
 Click "Apply/Save" when done.

Network Authentication:

WEP Encryption:

Figure 4-73

Note:

The PIN code of the adapter is always displayed on the QSS configuration screen.

Step 2: For the configuration of the wireless adapter, please choose **“Enter a PIN into my access point or a registrar”** in the configuration utility of the QSS as below, and click **Next**.

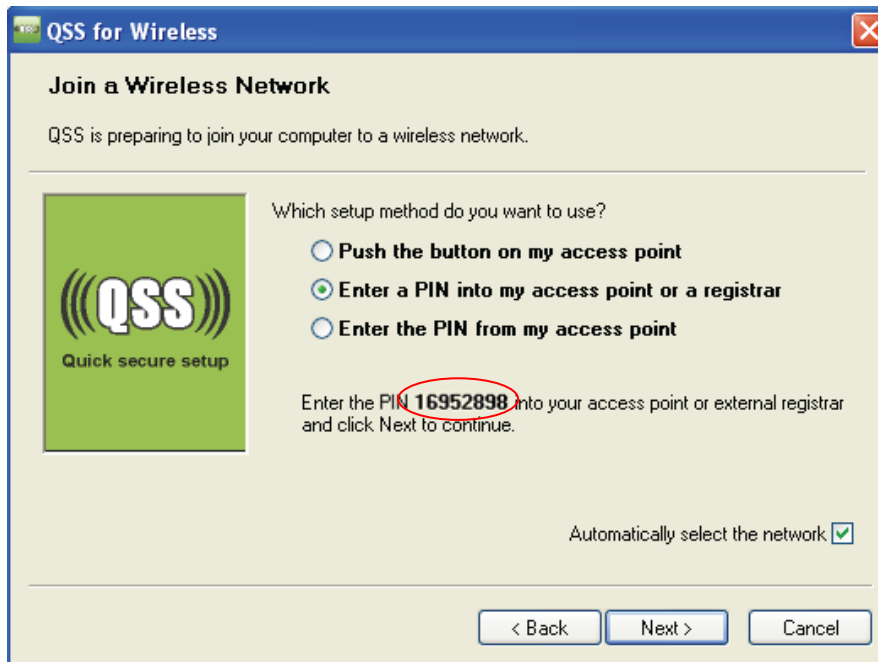

Figure 4-74

Note:

In this example, the default PIN code of this adapter is 16952898 as the preceding figure shown.

Method Two: Enter the PIN of my Router into the wireless adapter.

Step 1: Get the Current PIN code generated by the Router as shown below. You can click **Gen New PIN** to get a new PIN code for Router.

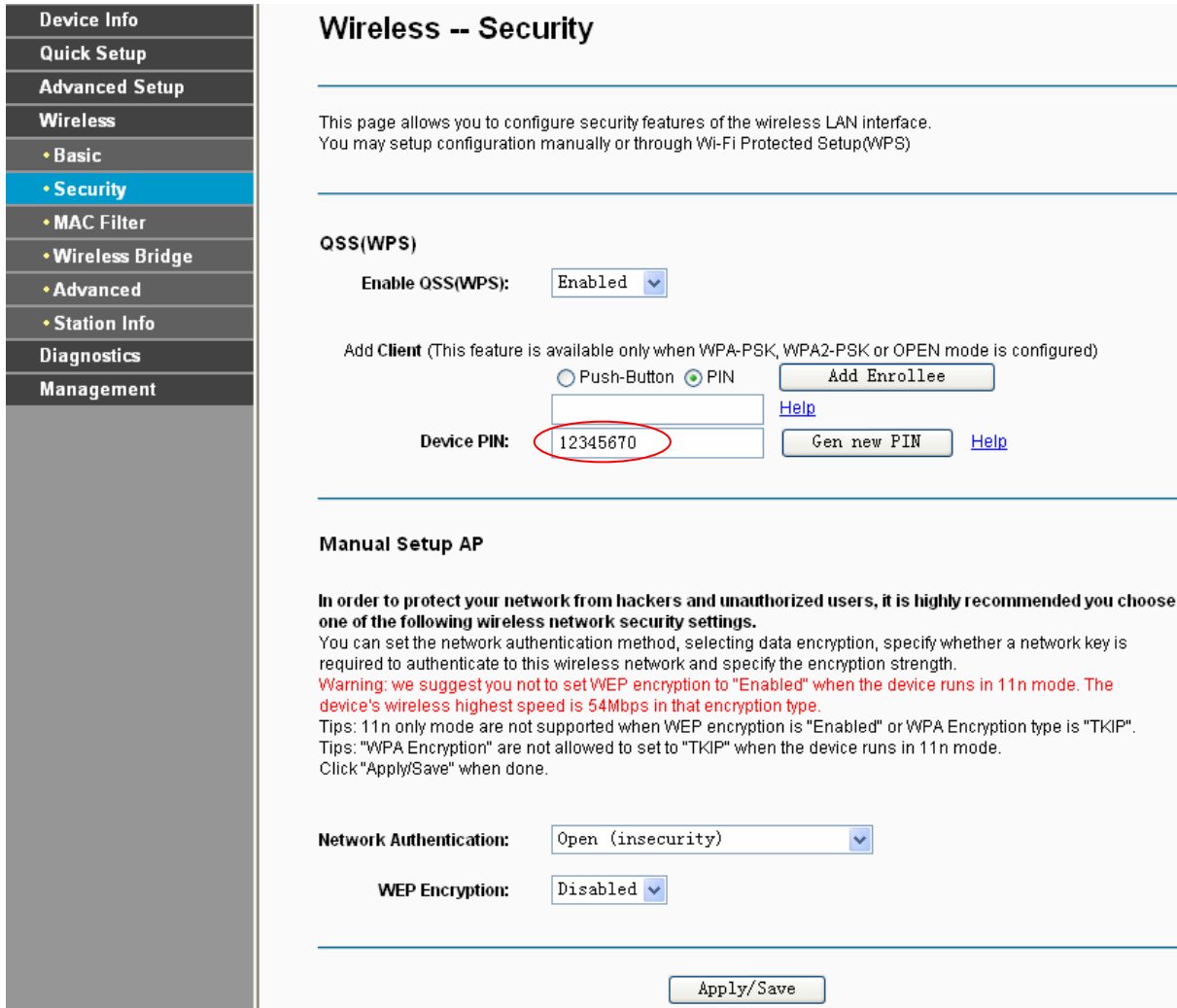

Figure 4-75

Step 2: For the configuration of the wireless adapter, please choose “**Enter a PIN from my access point**” in the configuration utility of the QSS as below, and enter the PIN code of the Router into the field after “**Access Point PIN**”. Then click **Next**.

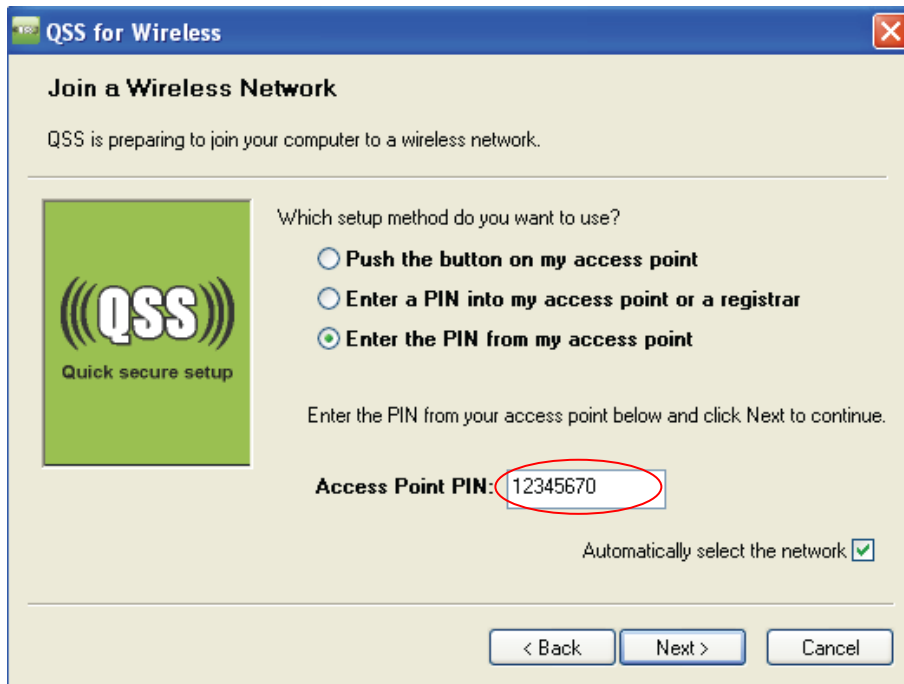

Figure 4-76

4.5.2.2 Manual Setup AP

Follow the instructions below to configure security features of the wireless LAN interface manually. You can set the network authentication method, select data encryption, specify whether a network key is required to authenticate to this wireless network and specify the encryption strength.

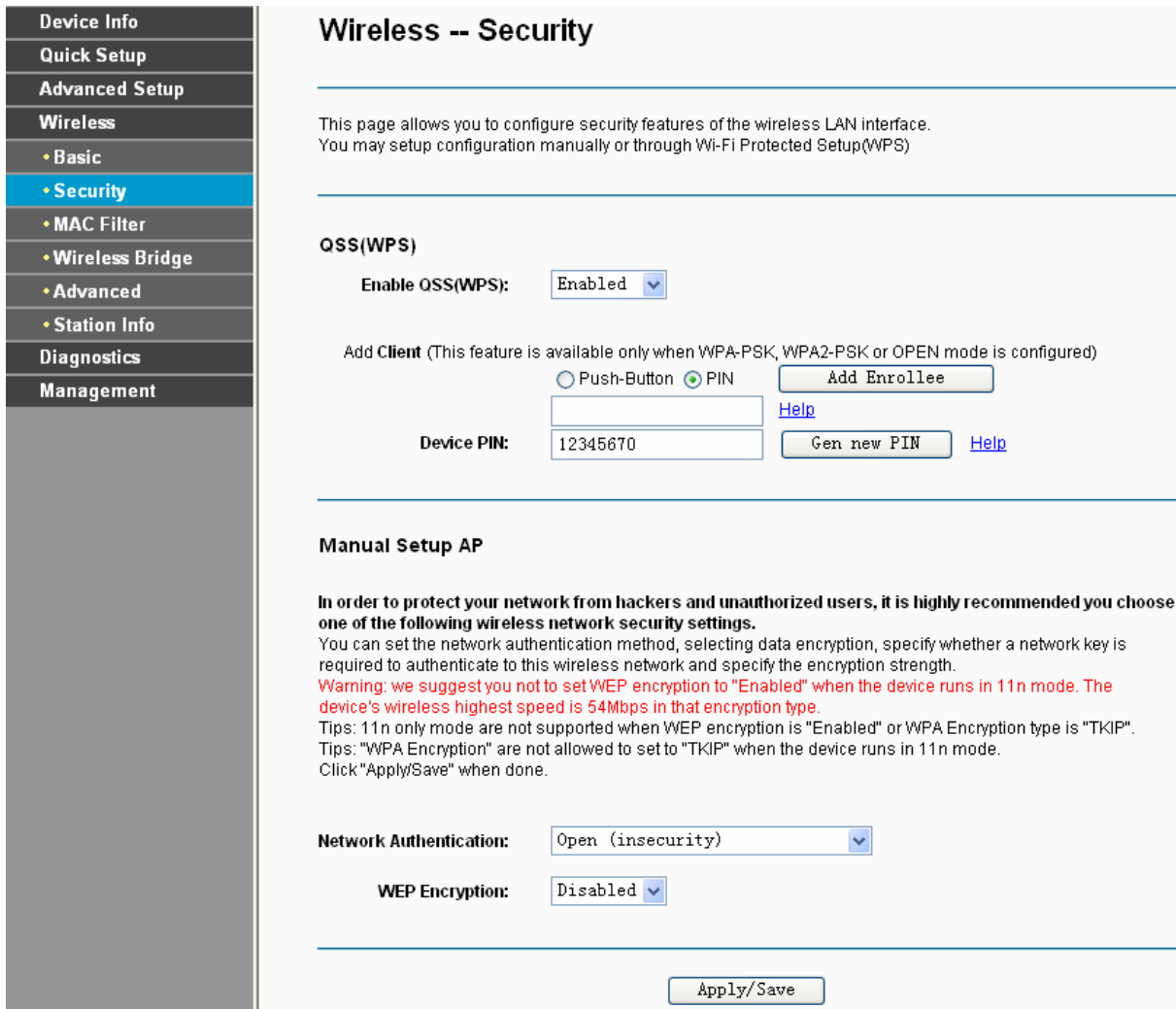

Figure 4-77

- **Network Authentication:** Select an authentication type from the drop-down list. Options available are: Open, Shared, WPA, WPA-PSK, WPA2, WPA2-PSK, Mixed WPA2/WPA, and Mixed WPA2/WPA-PSK.

Note:

For most users, it is recommended to use the default Wireless LAN Performance settings. Any changes made to these settings may adversely affect your wireless network. Under certain circumstances, changes may benefit performance. Carefully consider and evaluate any changes to these wireless settings.

1. WEP

WEP is a basic encryption method offering two levels of encryption, 64-bit and 128-bit encryption. To configure the WEP encryption, there are two ways.

- Keep the Network Authentication of **Open (insecurity)** and select **Enabled** from the WEP Encryption drop-down list, as shown in Figure 4-78. **Open (insecurity)** allows any wireless station to associate with the access point.
- Select **Shared (good)** from the Network Authentication drop-down list, as shown in Figure 4-79. **Shared (good)** only allows stations using a shared key encryption to associate with it. Shared key requires additional configuration of the keys to be used. Follow the instructions

below to configure the Shared Keys.

Wireless

- Basic
- **Security**
- MAC Filter
- Wireless Bridge
- Advanced
- Station Info

Diagnostics

Management

Manual Setup AP

In order to protect your network from hackers and unauthorized users, it is highly recommended you choose one of the following wireless network security settings.

You can set the network authentication method, selecting data encryption, specify whether a network key is required to authenticate to this wireless network and specify the encryption strength.

Warning: we suggest you not to set WEP encryption to "Enabled" or WPA encryption to "TKIP" when the device runs in 11n mode. The device's wireless highest speed is 54Mbps in these two encryption types.

Tips: 11n only mode are not supported when WEP encryption is "Enabled" or WPA Encryption type is "TKIP".

Click "Apply/Save" when done.

Network Authentication: Open (insecurity) ▼

WEP Encryption: Enabled ▼

Encryption Strength: 128-bit ▼

Current Network Key: 1 ▼

Network Key 1:

Network Key 2:

Network Key 3:

Network Key 4:

Enter 13 ASCII characters or 26 hexadecimal digits for 128-bit encryption keys
Enter 5 ASCII characters or 10 hexadecimal digits for 64-bit encryption keys

Figure 4-78

Device Info

Quick Setup

Advanced Setup

Wireless

- Basic
- **Security**
- MAC Filter
- Wireless Bridge
- Advanced
- Station Info

Diagnostics

Management

Manual Setup AP

In order to protect your network from hackers and unauthorized users, it is highly recommended you choose one of the following wireless network security settings.

You can set the network authentication method, selecting data encryption, specify whether a network key is required to authenticate to this wireless network and specify the encryption strength.

Warning: we suggest you not to set WEP encryption to "Enabled" when the device runs in 11n mode. The device's wireless highest speed is 54Mbps in that encryption type.

Tips: 11n only mode are not supported when WEP encryption is "Enabled" or WPA Encryption type is "TKIP".
Tips: "WPA Encryption" are not allowed to set to "TKIP" when the device runs in 11n mode.

Click "Apply/Save" when done.

Network Authentication: Shared (good) ▼

WEP Encryption: Enabled ▼

Encryption Strength: 128-bit ▼

Current Network Key: 1 ▼

Network Key 1:

Network Key 2:

Network Key 3:

Network Key 4:

Enter 13 ASCII characters or 26 hexadecimal digits for 128-bit encryption keys
Enter 5 ASCII characters or 10 hexadecimal digits for 64-bit encryption keys

Figure 4-79

- **Encryption strength:** Select the appropriate level of encryption, 64-bit or 128-bit.
- **Current Network Key:** To indicate which WEP key to use, select a transmission key number.
- **Network Key 1-4:** If you want to manually enter the WEP keys, then enter them in the network Key 1-4 fields.

Configure WEP Settings

1. Select **Shared (good)** from the **Network Authentication** drop-down list. The menu will change to offer the appropriate settings.
2. Select **64-bit** from the **WEP Encryption** drop-down list.
3. Select **“1”** from **Current Network Key** drop-down list.
4. Type in the password in the **Network Key 1** field.
5. Click **Save/Apply** to save the new configuration.

Manual Setup AP

In order to protect your network from hackers and unauthorized users, it is highly recommended you choose one of the following wireless network security settings.
 You can set the network authentication method, selecting data encryption, specify whether a network key is required to authenticate to this wireless network and specify the encryption strength.
Warning: we suggest you not to set WEP encryption to "Enabled" when the device runs in 11n mode. The device's wireless highest speed is 54Mbps in that encryption type.
 Tips: 11n only mode are not supported when WEP encryption is "Enabled" or WPA Encryption type is "TKIP".
 Tips: "WPA Encryption" are not allowed to set to "TKIP" when the device runs in 11n mode.
 Click "Apply/Save" when done.

Network Authentication: Shared (good)

WEP Encryption: Enabled

Encryption Strength: 64-bit

Current Network Key: 1

Network Key 1: 1234567890

Network Key 2:

Network Key 3:

Network Key 4:

Enter 13 ASCII characters or 26 hexadecimal digits for 128-bit encryption keys
 Enter 5 ASCII characters or 10 hexadecimal digits for 64-bit encryption keys

Apply/Save

Figure 4-80

Note:

We use **Network Authentication** Shared (good), **Encryption Strength** 64-bit, **Current Network Key** “1” and enter 10 hexadecimal digits”1234567890” in the **Network Key 1** for example, as shown in Figure 4-80 above.

2. WPA

WPA security for wireless communication has been developed to overcome some of the shortcomings of WEP. WPA combines the key generation with the authentication services of a RADIUS server.

Device Info
Quick Setup
Advanced Setup
Wireless
• Basic
• Security
• MAC Filter
• Wireless Bridge
• Advanced
• Station Info
Diagnostics
Management

Manual Setup AP

In order to protect your network from hackers and unauthorized users, it is highly recommended you choose one of the following wireless network security settings.
 You can set the network authentication method, selecting data encryption, specify whether a network key is required to authenticate to this wireless network and specify the encryption strength.
Warning: we suggest you not to set WEP encryption to "Enabled" when the device runs in 11n mode. The device's wireless highest speed is 54Mbps in that encryption type.
 Tips: 11n only mode are not supported when WEP encryption is "Enabled" or WPA Encryption type is "TKIP".
 Tips: "WPA Encryption" are not allowed to set to "TKIP" when the device runs in 11n mode.
 Click "Apply/Save" when done.

Network Authentication:

WPA Group Rekey Interval: (optional)

RADIUS Server IP Address:

RADIUS Port: (1-65535)

RADIUS Key: (optional)
 (You can enter ASCII characters between 0 and 63 characters or 0 to 64 Hexadecimal characters.)

WPA Encryption:

WEP Encryption:

Figure 4-81

- **WPA Group ReKey Interval:** Enter the Key Renewal period, which tells the Router how often it should change encryption keys.
- **RADIUS Server IP Address:** The IP address of the RADIUS server.
- **RADIUS Port:** The port of the RADIUS server. The default number is 1812.
- **RADIUS key:** The password of the RADIUS Server.
- **WPA Encryption:** Select the encryption you want to use: TKIP or AES (AES is an encryption method stronger than TKIP).

Configure WPA settings

1. Select **WPA** from the **Network Authentication** drop-down list. The menu will change to offer the appropriate settings.
2. Change the **WPA Group Rekey Interval** as desired.
3. Type in the IP address of the RADIUS server used in the **RADIUS Server IP Address** field.
4. Change the **RADIUS Port** if necessary.
5. Type in the password in the **RADIUS Key** field.
6. Use the default setting **AES** of WPA Encryption.
7. Click **Save/Apply** to save the new configuration.

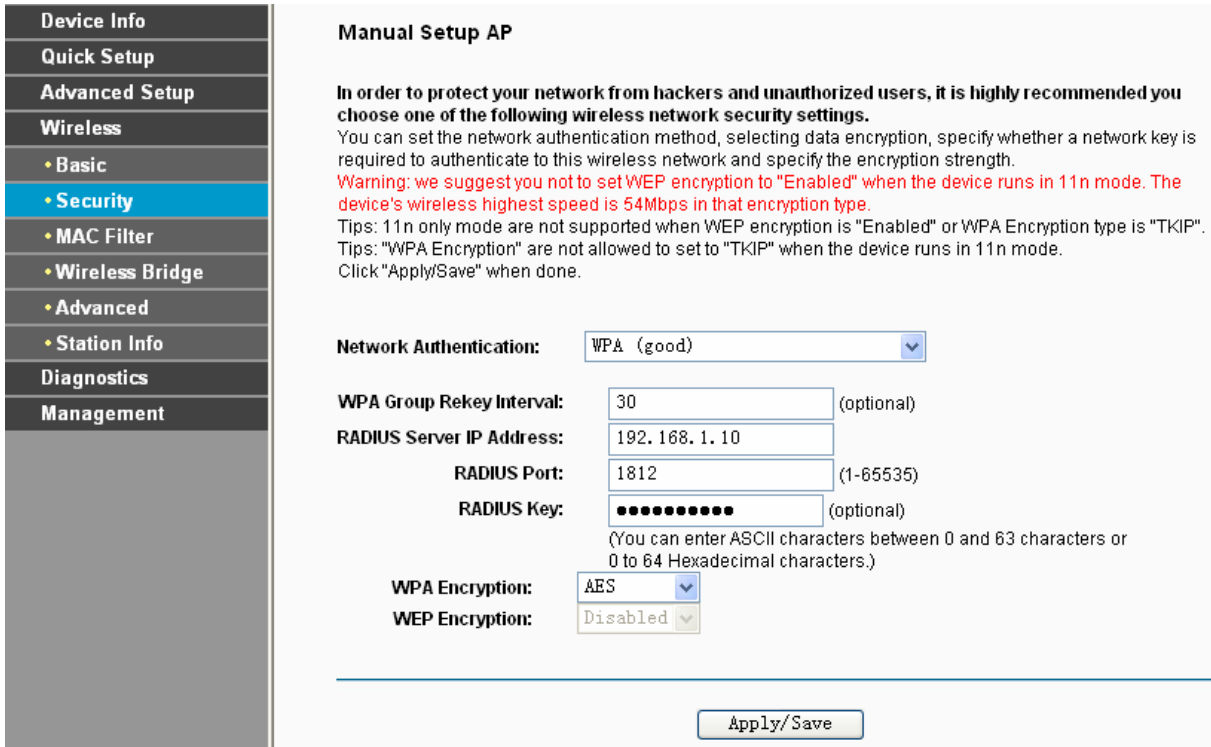

Figure 4-82

3. WPA-PSK

WPA-PSK requires a shared key and does not use a separate server for authentication. PSK keys can be ASCII or Hex type.

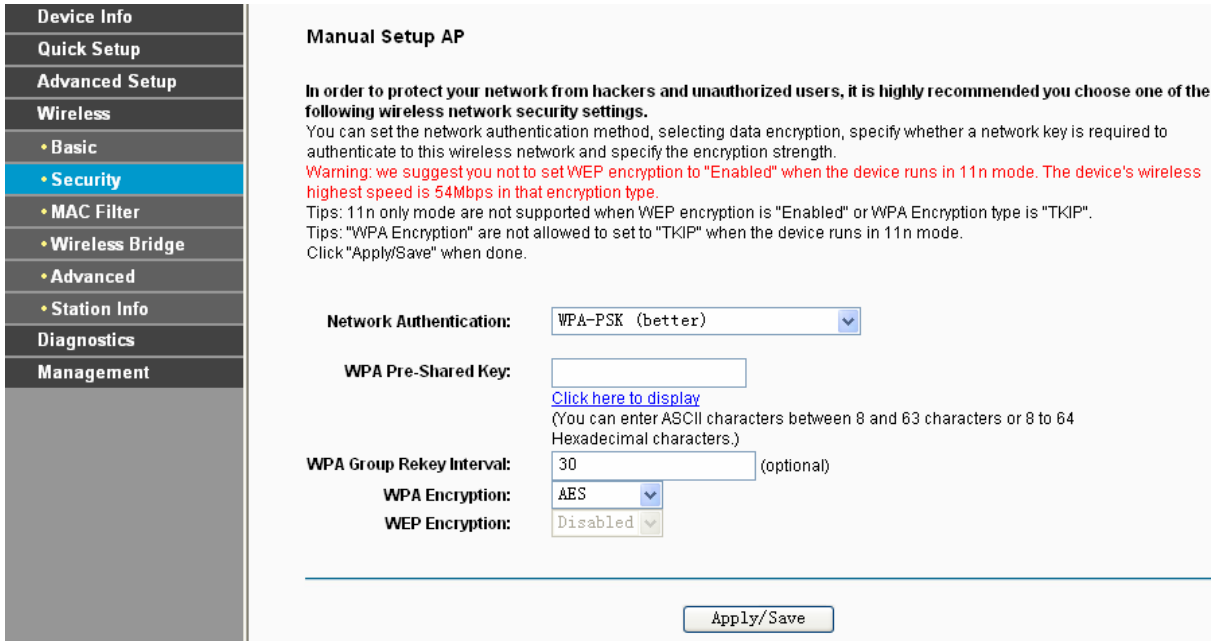

Figure 4-83

- **WPA Pre-Shared Key:** Enter the key shared by the Router and your other network devices. It must have 8-63 ASCII characters or 64 Hexadecimal digits.
- **Click here to display:** Click it to show you the WPA Pre-Shared Key.

Configure WPA-PSK settings

1. Select **WPA-PSK**. The menu will change to offer the appropriate settings as the picture show above.
2. WPA-PSK requires a shared key. Type the key in the space provided. PSK keys can be ASCII or Hex type.
3. Change the Group Key Interval as desired or use the default setting.
4. Click **Save/Apply** to save the new configuration.

The screenshot shows the 'Manual Setup AP' configuration page. On the left is a navigation menu with options: Device Info, Quick Setup, Advanced Setup, Wireless (Basic, Security, MAC Filter, Wireless Bridge, Advanced, Station Info), Diagnostics, and Management. The 'Security' option is selected. The main content area is titled 'Manual Setup AP' and contains the following text:

In order to protect your network from hackers and unauthorized users, it is highly recommended you choose one of the following wireless network security settings.
 You can set the network authentication method, selecting data encryption, specify whether a network key is required to authenticate to this wireless network and specify the encryption strength.
Warning: we suggest you not to set WEP encryption to "Enabled" when the device runs in 11n mode. The device's wireless highest speed is 54Mbps in that encryption type.
 Tips: 11n only mode are not supported when WEP encryption is "Enabled" or WPA Encryption type is "TKIP".
 Tips: "WPA Encryption" are not allowed to set to "TKIP" when the device runs in 11n mode.
 Click "Apply/Save" when done.

The configuration fields are:

- Network Authentication:** WPA-PSK (better)
- WPA Pre-Shared Key:** A text box containing ten dots, with a link 'Click here to display' below it. A note states: '(You can enter ASCII characters between 8 and 63 characters or 8 to 64 Hexadecimal characters.)'
- WPA Group Rekey Interval:** 30 (optional)
- WPA Encryption:** AES
- WEP Encryption:** Disabled

An 'Apply/Save' button is located at the bottom right of the configuration area.

Figure 4-84

Note:

If you click the option "Click here to display", the Figure 4-85 will pop-up, and it shows the password you have set.

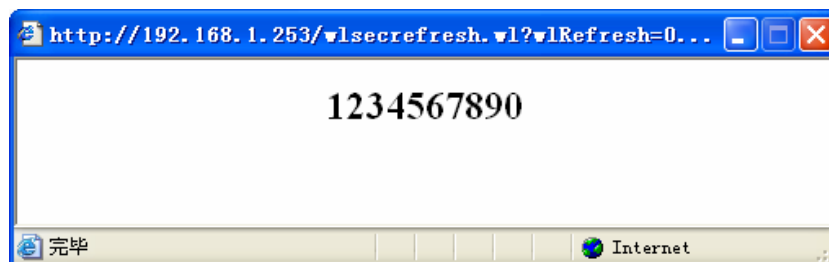

Figure 4-85

4. WPA2

To configure WPA2 settings, select the WPA2 option from the drop-down list. The menu will change to offer the appropriate settings. The steps of these settings are similar to WPA settings.

Manual Setup AP

In order to protect your network from hackers and unauthorized users, it is highly recommended you choose one of the following wireless network security settings.

You can set the network authentication method, selecting data encryption, specify whether a network key is required to authenticate to this wireless network and specify the encryption strength.

Warning: we suggest you not to set WEP encryption to "Enabled" or WPA encryption to "TKIP" when the device runs in 11n mode. The device's wireless highest speed is 54Mbps in these two encryption types.

Tips: 11n only mode are not supported when WEP encryption is "Enabled" or WPA Encryption type is "TKIP". Click "Apply/Save" when done.

Network Authentication: WP&A2 (better)

WPA2 Preauthentication: Disabled

Network Re-auth Interval: 36000 (optional)

WPA Group Rekey Interval: 0 (optional)

RADIUS Server IP Address: 0.0.0.0

RADIUS Port: 1812 (1-65535)

RADIUS Key: (optional)
(You can enter ASCII characters between 0 and 63 characters or 0 to 64 Hexadecimal characters.)

WPA Encryption: AES

WEP Encryption: Disabled

Apply/Save

Figure 4-86

- **WPA2 Preauthentication:** Select Enable from the drop-down list, Stations will authenticate with the AP during the scanning process, and once association is required, the station has been already authenticated.
- **Network Re-auth Interval:** Enter a value in seconds as the frequency interval to enable periodic Network Re-authentication function, while leave it blank or enter "0" to disable it.

5. WPA2-PSK

To configure WPA2-PSK settings, select the WPA2-PSK option from the drop-down list. The menu will change to offer the appropriate settings. WPA2-PSK requires a shared key and does not use a separate server for authentication. PSK keys can be ASCII or Hex type.

Device PIN: 11812777 [Help](#) [Gen new PIN](#) [Help](#)

Manual Setup AP

In order to protect your network from hackers and unauthorized users, it is highly recommended you choose one of the following wireless network security settings.

You can set the network authentication method, selecting data encryption, specify whether a network key is required to authenticate to this wireless network and specify the encryption strength.

Warning: we suggest you not to set WEP encryption to "Enabled" or WPA encryption to "TKIP" when the device runs in 11n mode. The device's wireless highest speed is 54Mbps in these two encryption types.

Tips: 11n only mode are not supported when WEP encryption is "Enabled" or WPA Encryption type is "TKIP". Click "Apply/Save" when done.

Network Authentication: WP&A2-PSK (best)

WPA Pre-Shared Key: [Click here to display](#)
(You can enter ASCII characters between 8 and 63 characters or 8 to 64 Hexadecimal characters.)

WPA Group Rekey Interval: 0 (optional)

WPA Encryption: AES

WEP Encryption: Disabled

Apply/Save

Figure 4-87

6. Mixed WPA2/WPA

To configure Mixed WPA2/WPA settings, select the Mixed WPA2/WPA option from the drop-down list. The menu will change to offer the appropriate settings. The steps to these settings are similar to those for WPA-PSK.

Manual Setup AP

In order to protect your network from hackers and unauthorized users, it is highly recommended you choose one of the following wireless network security settings.
 You can set the network authentication method, selecting data encryption, specify whether a network key is required to authenticate to this wireless network and specify the encryption strength.
Warning: we suggest you not to set WEP encryption to "Enabled" or WPA encryption to "TKIP" when the device runs in 11n mode. The device's wireless highest speed is 54Mbps in these two encryption types.
 Tips: 11n only mode are not supported when WEP encryption is "Enabled" or WPA Encryption type is "TKIP".
 Click "Apply/Save" when done.

Network Authentication: Mixed WPA2/WPA (adaptive) (dropdown)

WPA2 Preauthentication: Disabled (dropdown)

Network Re-auth Interval: 36000 (optional)

WPA Group Rekey Interval: 0 (optional)

RADIUS Server IP Address: 0.0.0.0

RADIUS Port: 1812 (1-65535)

RADIUS Key: (optional)
 (You can enter ASCII characters between 0 and 63 characters or 0 to 64 Hexadecimal characters.)

WPA Encryption: AES (dropdown)

WEP Encryption: Disabled (dropdown)

Apply/Save

Figure 4-88

7. Mixed WPA2/WPA-PSK

To configure Mixed WPA2/WPA-PSK settings, select the Mixed WPA2/WPA-PSK option from the drop-down list. The menu will change to offer the appropriate settings. The steps of this setting are the same with WPA-PSK.

Manual Setup AP

In order to protect your network from hackers and unauthorized users, it is highly recommended you choose one of the following wireless network security settings.
 You can set the network authentication method, selecting data encryption, specify whether a network key is required to authenticate to this wireless network and specify the encryption strength.
Warning: we suggest you not to set WEP encryption to "Enabled" when the device runs in 11n mode. The device's wireless highest speed is 54Mbps in that encryption type.
 Tips: 11n only mode are not supported when WEP encryption is "Enabled" or WPA Encryption type is "TKIP".
 Tips: "WPA Encryption" are not allowed to set to "TKIP" when the device runs in 11n mode.
 Click "Apply/Save" when done.

Network Authentication: Mixed WPA2/WPA-PSK (adaptive) (dropdown)

WPA Pre-Shared Key: (text input)
[Click here to display](#)
 (You can enter ASCII characters between 8 and 63 characters or 8 to 64 Hexadecimal characters.)

WPA Group Rekey Interval: 30 (optional)

WPA Encryption: AES (dropdown)

WEP Encryption: Disabled (dropdown)

Apply/Save

Figure 4-89

4.5.3 MAC Filter

Choose “Wireless”→”MAC Filter”, you will see the screen of **Wireless--MAC Filter** settings shown as below.

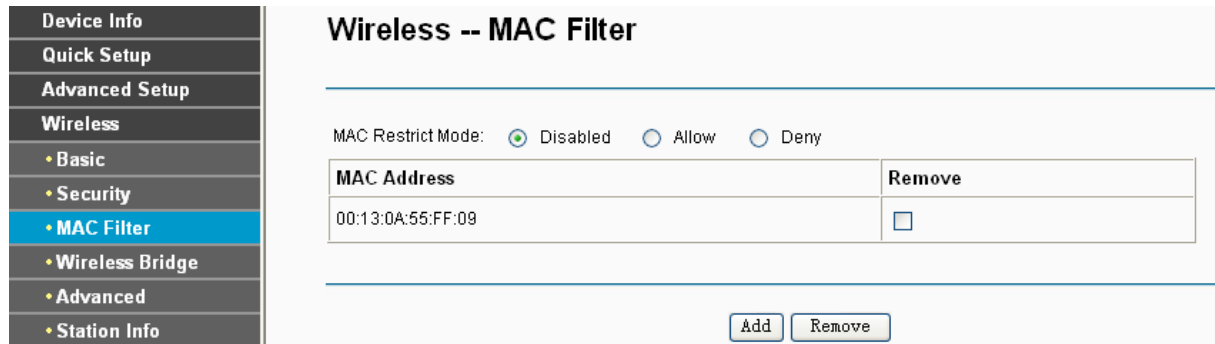

Figure 4-90

Wireless access can be filtered by using the MAC addresses of the wireless devices transmitting within your network’s RADIUS. To filter wireless users by MAC Address, either permitting or blocking access. If you do not wish to filter users by MAC Address, select Disabled.

- **Disabled:** Select this option to disable MAC Filter function.
- **Allow:** Select this option to enable MAC Filter function that allow wireless access by the devices listed on this screen.
- **Deny:** Select this option to enable MAC Filter function that block wireless access from the devices listed on this screen.
- **Add:** Click this button to add the MAC Address.
- **Remove:** Select the item of the MAC Address and click this button to remove it.

When you click the **Add** button, the pop-up picture shown below, and then you can type the MAC Address in the **MAC Address** field.

Note:

The form of MAC Address must be “xx:xx:xx:xx:xx:xx”, like “00:13:0A:55:FF:09”.

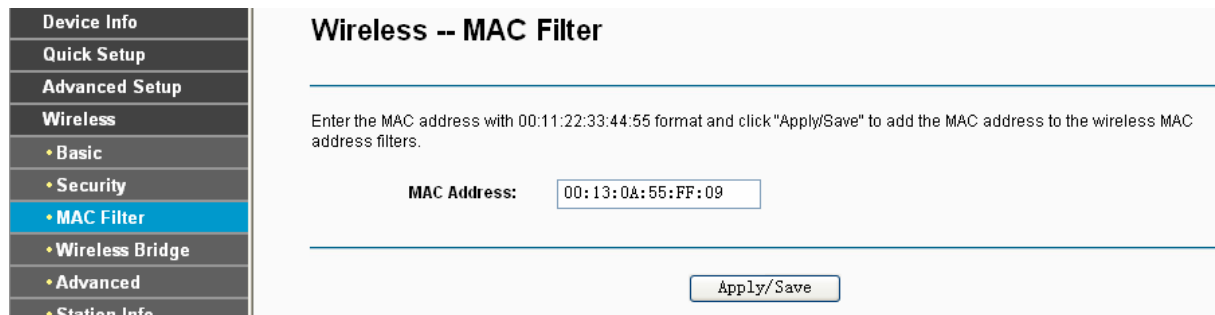

Figure 4-91

When you finished making changes to the MAC Filter List screen, click **Save/Apply** to save the changes.

4.5.4 Wireless Bridge

Choose “Wireless”→”Wireless Bridge”, you will see the screen of **Wireless--Bridge** settings shown as below. You can configure wireless bridge features of the wireless LAN interface and click **Apply/Save** button to save the current configuration.

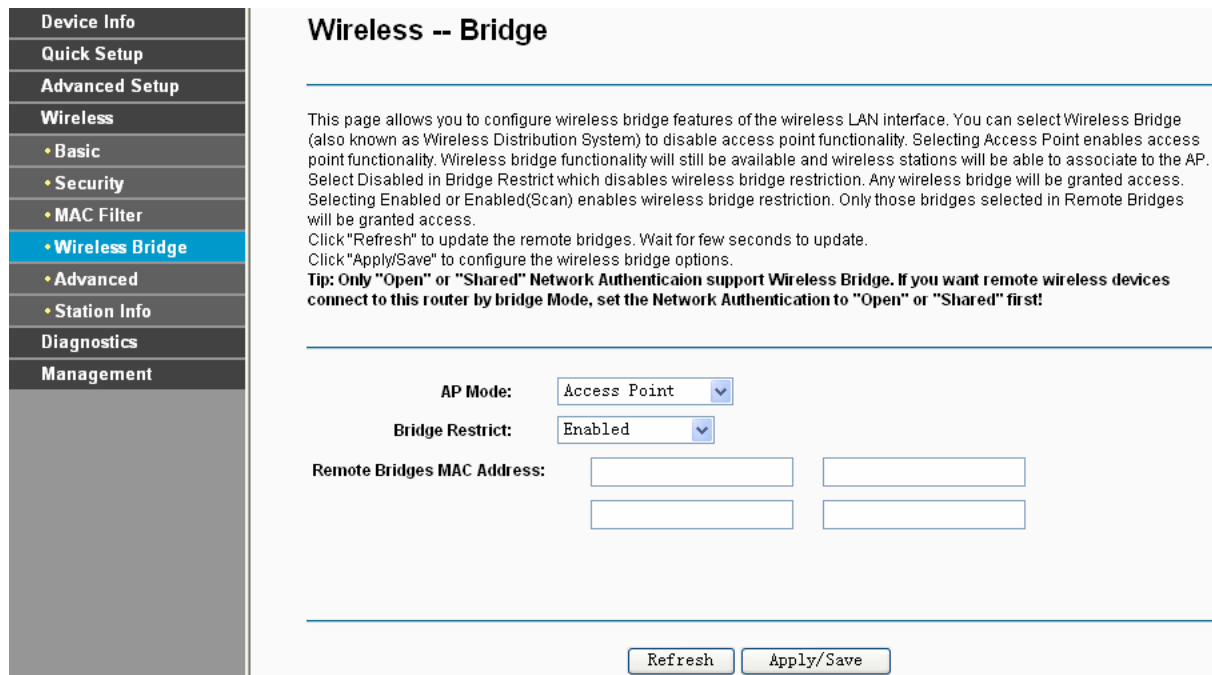

Figure 4-92

- **AP Mode:** Select an AP Mode from the drop-down list. Options available are: Access Point and Wireless Bridge.
 - **Access Point:** Select this option to allow wireless stations including AP clients to access.
 - **Wireless Bridge:** Also known as WDS (Wireless Distribution System), it will bridges the wireless stations which also in bridge mode to connect two or more remote LANs.
- **Bridge Restrict:**
 - **Disabled:** Select this option to disables wireless bridge restriction, that any wireless bridge will be granted access.
 - **Enabled:** Select this option (as shown below) to enables wireless bridge restriction, please enter the MAC address of the Remote Bridges that you want to connect with, and only these Remote Bridges are granted access.

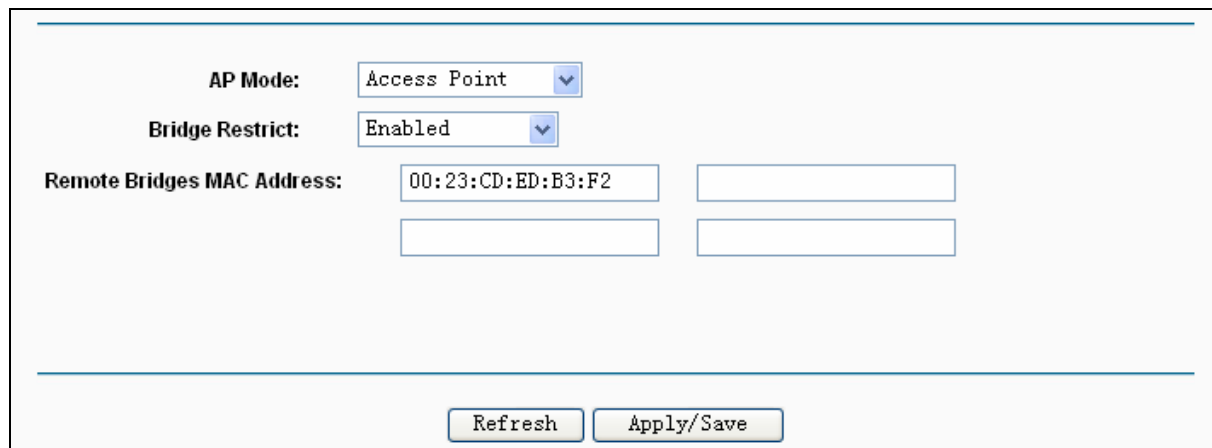

Figure 4-93

- **Enabled (Scan):** Select this option to enables wireless bridge restriction, and it will scan the environment for APs that exist around the device. Only those selected AP will be granted access.
- **Refresh:** Click this button to scan and display the APs.

AP Mode:

Bridge Restrict:

Remote Bridges MAC Address:

	SSID	BSSID
<input type="checkbox"/>	TP-LINK	00:19:E0:94:51:F4

Refresh Apply/Save

Figure 4-94

Note:

Only Open or Shared authentication method support wireless bridge, you should choose **“Wireless”→“Security”** to change authentication method to “open” or “shared” mode first.

4.5.5 Advanced

Choose **“Wireless”→“Advanced”**, you will see the screen of **Wireless--Advanced** settings shown as below.

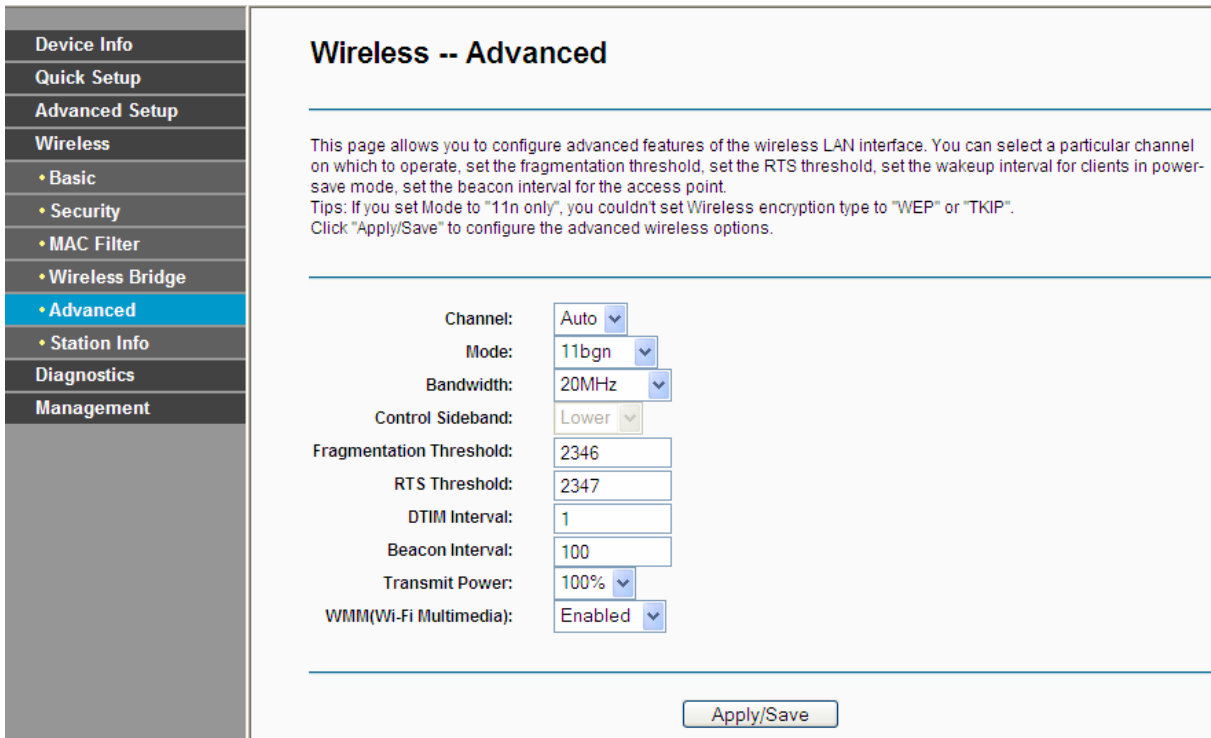

Figure 4-95

- **Channel:** Select the channel you want to use from the drop-down List. This field determines which operating frequency will be used. It is not necessary to change the wireless channel unless you notice interference problems with another nearby access point.
- **Mode:** In the drop-down list you can select “11b”, “11bg”, “11bgn” and “11n only”. “11bgn” allows both 802.11b, 802.11g and 802.11n wireless stations to connect to the Router.
- **Bandwidth:** Select the Bandwidth you want to use from the drop-down List. If bigger bandwidth is selected, device could transmit and receive data with higher speed.
- **Control Sideband:** If bigger bandwidth is selected, this option will allow you select the Control Sideband you want.
- **Fragmentation Threshold:** This value specifies the maximum size for a packet before data is fragmented into multiple packets. If you experience a high packet error rate, you may slightly increase the Fragmentation Threshold. Setting the Fragmentation Threshold too low may result in poor network performance. Only minor reduction of the default value is recommended. In most cases, it should remain at its default value of 2346.
- **RTS Threshold:** Should you encounter inconsistent data flow, only minor reduction of the default value 2347 is recommended. If a network packet is smaller than the preset RTS threshold size, the RTS/CTS mechanism will not be enabled. The Router sends Request to Send (RTS) frames to a particular receiving station and negotiates the sending of a data frame. After receiving an RTS, the wireless station responds with a Clear to Send (CTS) frame to acknowledge the right to begin transmission. In most cases, keep its default value of 2347.
- **DTIM Interval:** This value, between 1 and 255, indicates the interval of the Delivery Traffic Indication Message (DTIM). A DTIM field is a countdown field informing clients of the next window for listening to broadcast and multicast messages. When the Router has buffered broadcast or multicast messages for associated clients, it sends the next DTIM with a DTIM

Interval value. Its clients hear the beacons and awaken to receive the broadcast and multicast messages. The default value is 1.

- **Beacon Interval:** Enter a value between 20-1000 milliseconds. The Beacon Interval value indicates the frequency interval of the beacon. A beacon is a packet broadcast by the Router to synchronize the wireless network. The default value is 100.
- **Transmit Power:** This option will allow you to configure the wireless transmit power. High transmit power will extend the wireless signal range of the device and make the signal transmit more legible. Low transmit power with the smaller wireless signal range that will decrease the probability of interrupt by other Wi-Fi device.
- **WMM (Wi-Fi Multimedia):** This function can guarantee the packets with high-priority messages being transmitted preferentially. It is strongly recommended.

4.5.6 Station info

Choose “**Wireless**”→” **Station Info**”, you will see the screen of **Wireless--Authenticated Stations** setting shown as below.

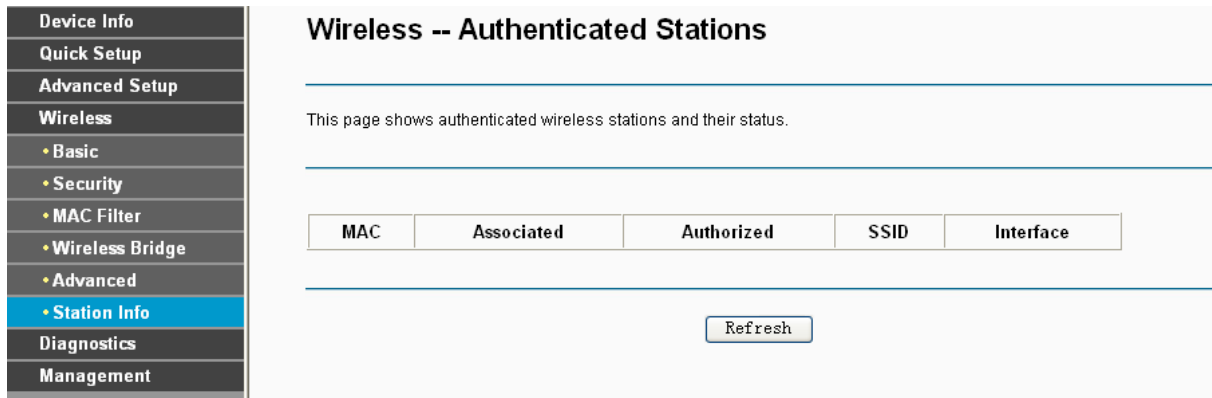

Figure 4-96

This page shows authenticated wireless stations and their status.

- **MAC:** Displays the connected wireless station's MAC address.
- **Associated:** Displays whether the wireless station has associated with the access point.
- **Authorized:** Displays the information of Authentication.
- **SSID:** Displays the connected wireless station's SSID.
- **Interface:** Displays the connected wireless station's Interface mode.

4.6 Diagnostics

Choose “**Diagnostics**”, you will see the Diagnostics screen. This section describes the result of the test for the ENET (Ethernet) Connection, Wireless Connection and ADSL Synchronization. You can refer to the **Help** menu to get more information about the corresponding test.

Device Info

Quick Setup

Advanced Setup

Wireless

Diagnostics

Management

pvc_quick_setup Diagnostics

Your modem is capable of testing your DSL connection. The individual tests are listed below. If a test displays a fail status, click "Rerun Diagnostic Tests" at the bottom of this page to make sure the fail status is consistent. If the test continues to fail, click "Help" and follow the troubleshooting procedures.

Test the connection to your local network

Test your LAN(1-4) Connection:	PASS	Help
Test your Wireless Connection:	PASS	Help

Test the connection to your DSL service provider

Test xDSL Synchronization:	FAIL	Help
Test ATM OAM F5 segment ping:	DISABLED	Help
Test ATM OAM F5 end-to-end ping:	DISABLED	Help

Test the connection to your Internet service provider

Test PPP server connection:	DISABLED	Help
Test authentication with ISP:	DISABLED	Help
Test the assigned IP address:	DISABLED	Help
Ping default gateway:	FAIL	Help
Ping primary Domain Name Server:	FAIL	Help

Figure 4-97

4.7 Management

Choose "Management", there are eight submenus under the main menu. They are **Settings**, **System Log**, **SNMP Agent**, **TR-069 Client**, **Access Control**, **Update Software** and **Reboot**. Click any of them, and you will be able to configure the corresponding function.

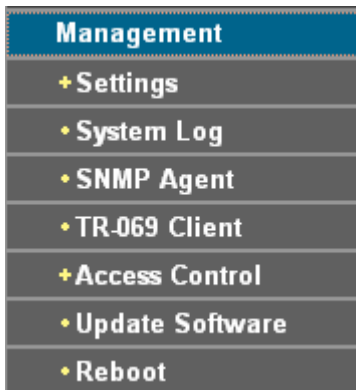

4.7.1 Settings

This section provides three important functions for managing the Router; they are **Backup**, **Update** and **Restore Default** (shown in Figure 4-98). The detailed manipulations are described below.

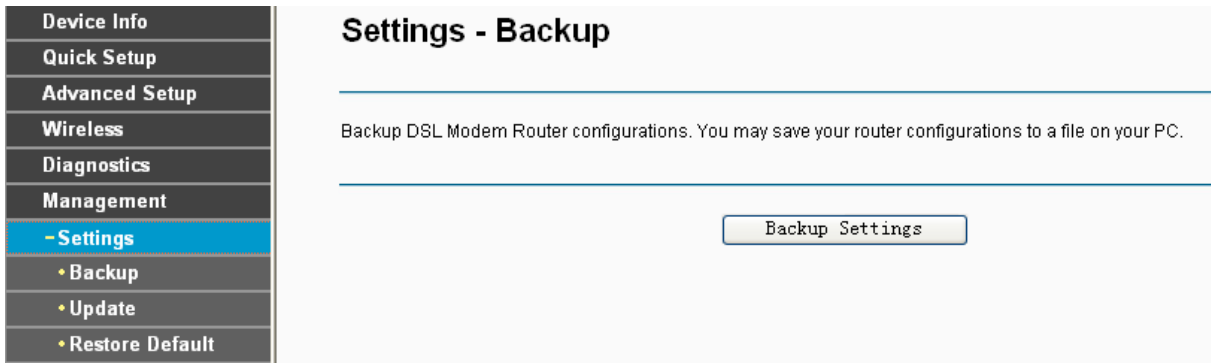

Figure 4-98

4.7.1.1 Export

Choose “**Management**”→“**Settings**”→“**Export**”, you can see the **Export** screen, this screen (shown in Figure 4-99) allows you to save the current configuration of the Router as a backup file.

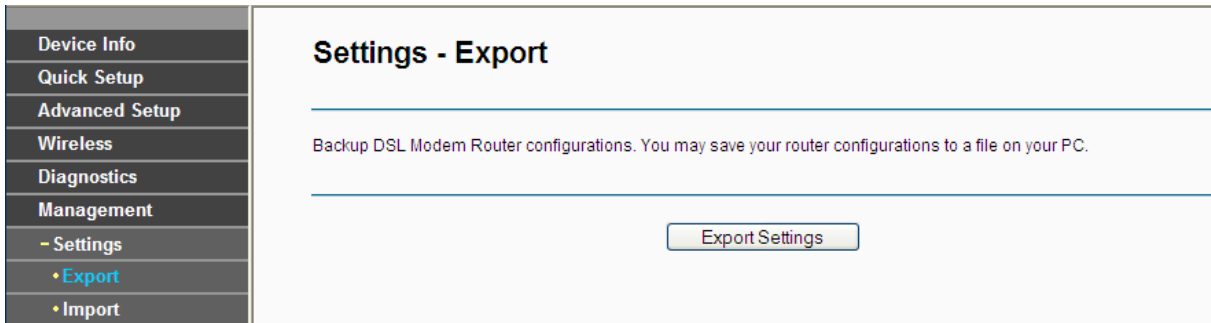

Figure 4-99

To back up the Router’s current settings:

1. Click the **Export Settings** button on the preceding screen (pop-up Figure 4-99), the following screen will then appear (shown in Figure 4-100).

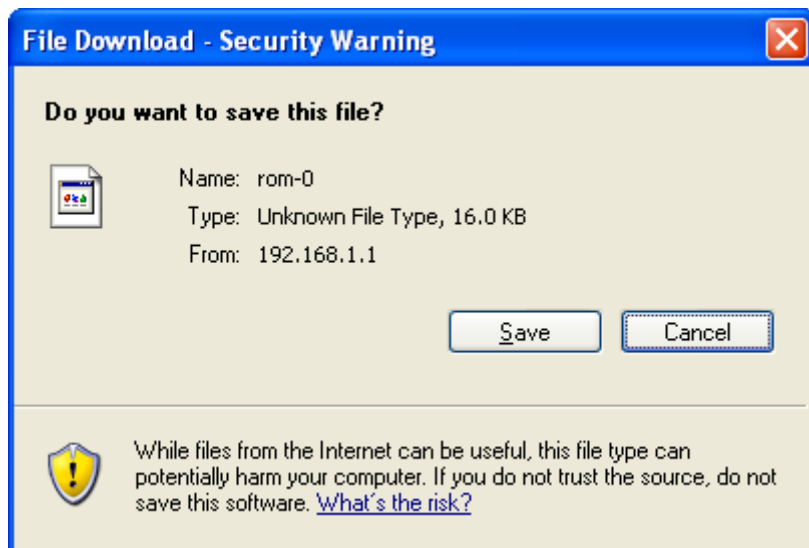

Figure 4-100

2. Click the **Save** button, and save the file as the appointed file (shown in Figure 4-101).

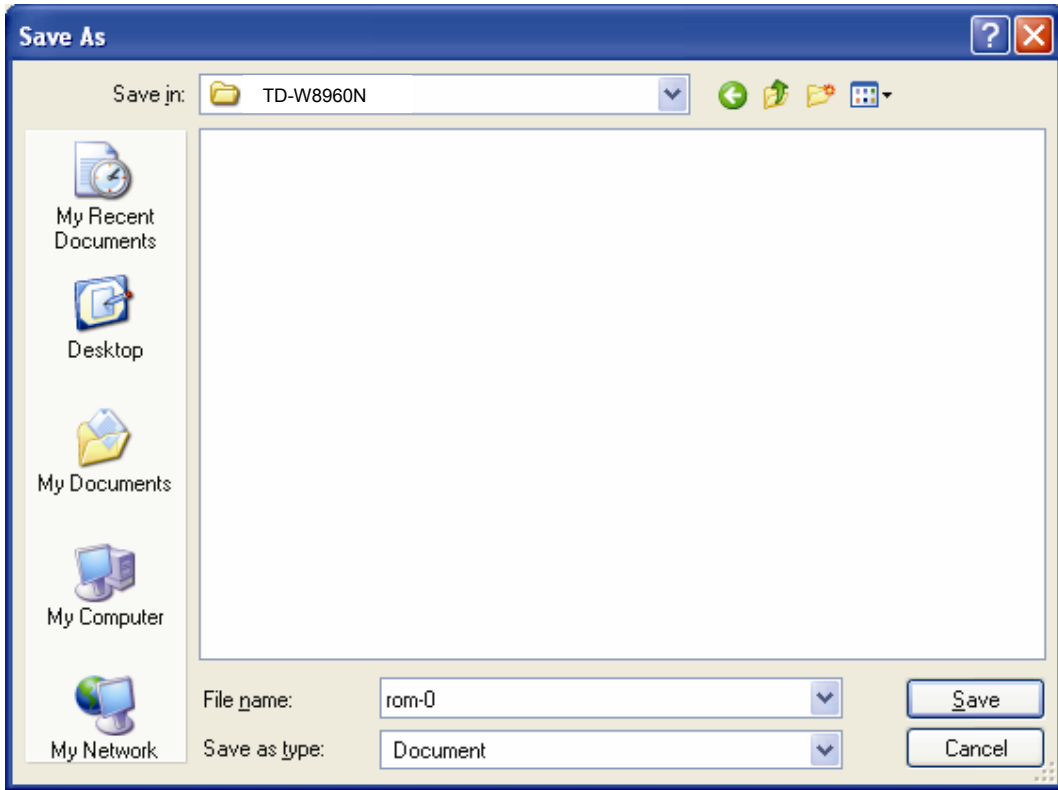

Figure 4-101

4.7.1.2 Import

Choose “**Management**”→“**Settings**”→“**Import**”, you can see the **Import** screen, this screen (shown in Figure 4-102) allows you to update the Router’s settings.

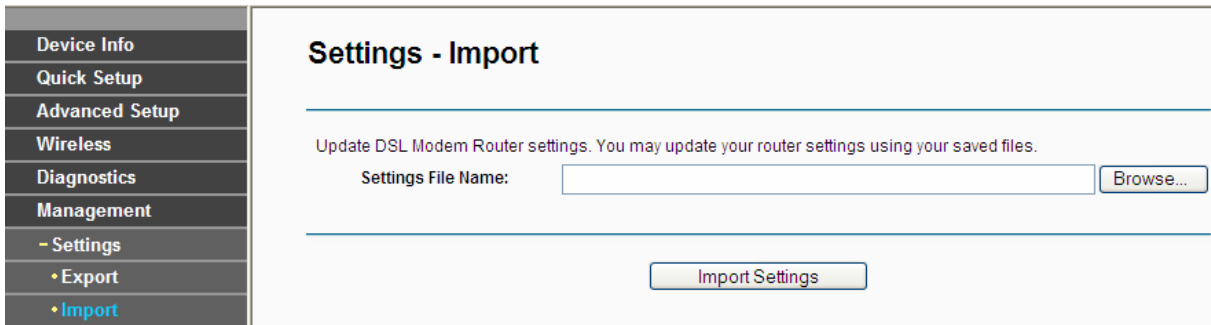

Figure 4-102

To update the Router’s settings:

1. Click the **Browse** button to locate the update file for the device, and you can also enter the exact path to the Setting file in the text box.
2. After you have selected the file for updating the settings, click the **Import Settings** button.

 **Note:**

The Router will reboot upon completion. This process will take a while, don’t turn off the Router or press the **Reset** button while processing.

4.7.1.3 Restore Default

Choose “Management”→“Settings”→“Restore Default”, you can see the **Restore Default** screen, this screen (shown in Figure 4-103) allows you to restore the Router’s configuration to the factory defaults on the screen.

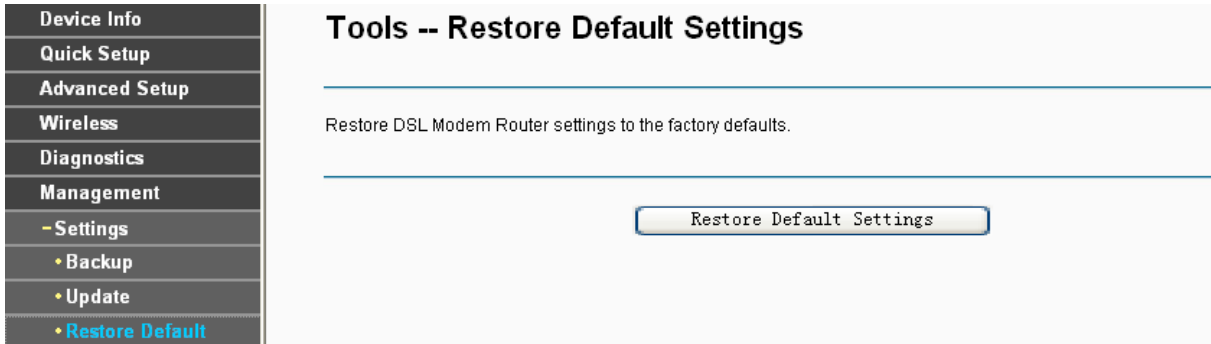

Figure 4-103

- **Restore Default Settings:** Click this button to restore the Router’s configuration to the factory defaults, and then follow the on-screen instructions to complete it.
- **Account and Password:** The default **account name** and its **password** are both admin.
- The default **IP Address:** 192.168.1.1.
- The default **Subnet Mask:** 255.255.255.0.

4.7.2 System Log

Choose “Management”→“System Log”, you can see the **System Log** screen, this screen (shown in Figure 4-104) allows you to view the system log and configure the system log options.

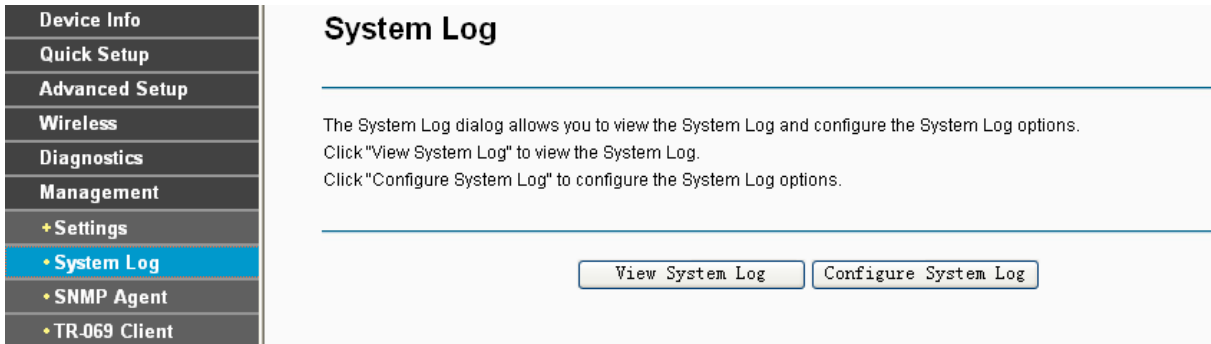

Figure 4-104

To View the System Log:

Click the **View System Log** button, you will see the screen (shown in Figure 4-105) which displays the Router’s recent logs.

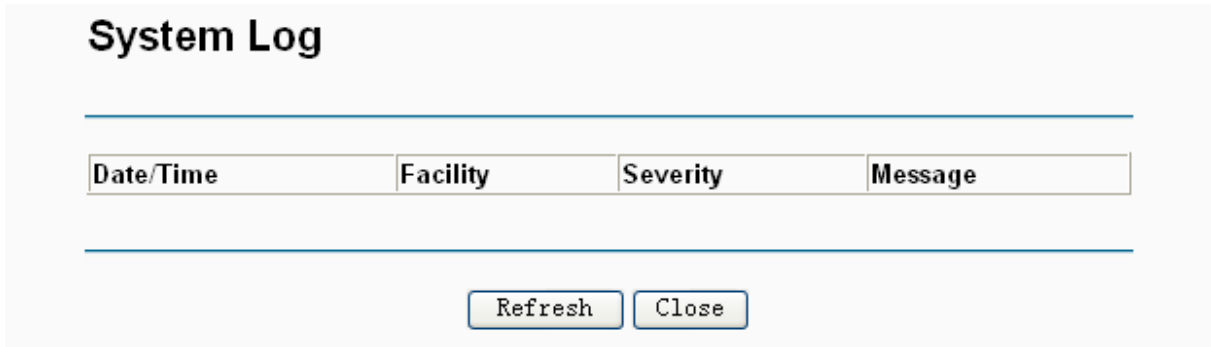

Figure 4-105

- **Refresh:** Click the button, the information in the table will be updated.
- **Close:** Click the button, the screen will be closed.

To Configure the System Log Settings:

Click the **Configure System Log** button (shown in Figure 4-104), you will see the screen below (shown in Figure 4-106).

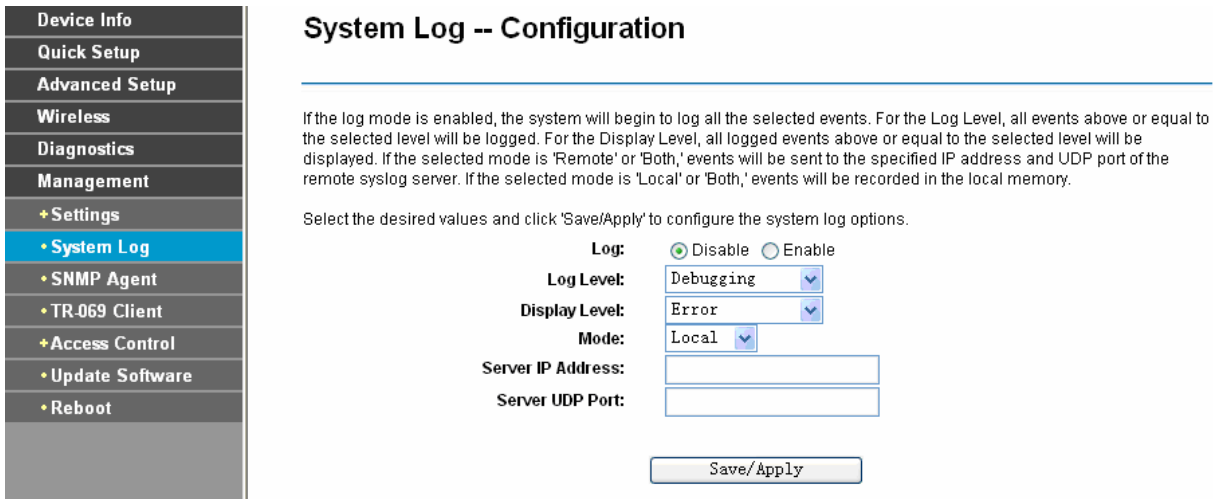

Figure 4-106

- **Disable/Enable:** Select the **Enable** to log the events, if you don't want to log these events, please select **Disable**.
- **Log Level:** Select the Log level in the drop-down list, for the Log level, all events above or equal to the selected level will be logged.
- **Display Level:** Select the Display level in the drop-down list, for the Display Level, all logged events above or equal to the selected level will be displayed.
- **Mode:** Select the mode to record the events. If the selected mode is **Local**, events will be recorded in the local memory. If the selected mode is **Remote**, events will be sent to the specified IP address and UDP port of the remote system log server. If the selected mode is **Both**, events will be sent to the local memory and the remote system log server.
- **Server IP Address:** Type the address of the server you want to record the events.
- **Server UDP Port:** Type the UDP Port of the server.

4.7.3 SNMP Agent

Choose “**Management**”→“**SNMP Agent**”, you can see the SNMP-Configuration screen as shown below.

SNMP (Simple Network Management Protocol) has been widely applied in the computer networks currently, which is used for ensuring the transmission of the management information between any two nodes. In this way, network administrators can easily search and modify the information on any node on the network. Meanwhile, they can locate faults promptly and implement the fault diagnosis, capacity planning and report generating.

An **SNMP Agent** is an application running on the Router that performs the operational role of receiving and processing SNMP messages, sending responses to the SNMP manager, and sending traps when an event occurs. So a Router contains SNMP "agent" software can be monitored and/or controlled by SNMP Manager using SNMP messages.

An **SNMP Manager** or SNMP Service is an application that performs the operational roles of generating SNMP messages/requests to modify and retrieve management information, and receiving the requested information and trap-event reports that are generated by the SNMP agent. SNMP Manager is the third-party management system. Monitor one is an SNMP Manager.

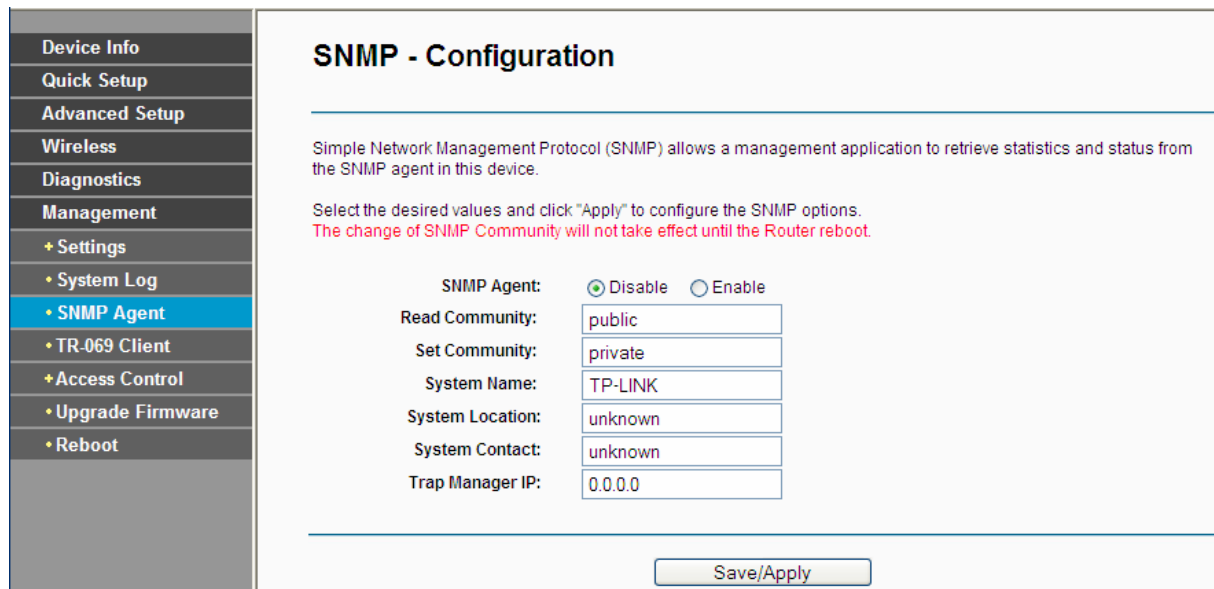

Figure 4-107

➤ **SNMP Agent:** You can select the checkbox to disable or enable the function.

Note:

SNMP Community string provides a simple method of authentication between the Router (SNMP Agent) and a remote network manager (SNMP Manager). You can specify the community string as the password to authenticate the management station to the Router.

➤ **Read Community:** This field allows you to specify the SNMP Community string which provides read-only access to the Router that the community is only permitted to read the device configuration. The default value is “public”.

➤ **Set Community:** This field allows you to specify the SNMP Community string which provides read and write access to the Router that the community has the authority to read and change the device configuration. The default value is “public”.

- **System Name:** Enter alphanumeric string to specify an SNMP community string name. Your Router (SNMP agents) will expose management data on the managed systems as this "system name".
- **System Location:** The person to notify when problems occur.
- **System contact:** The location of the person that is identified as the system contact.
- **Trap Manager IP:** Enter the IP address of the SNMP Manager, where the SNMP Agent forwards trap notifications.

Select the desired values and click **Save/Apply** to configure the SNMP options.

4.7.4 TR-069 client

Choose “**Management**”→“**TR-069 client**”, you can see the TR-069 client - Configuration screen as shown below.

TR-069 (WAN Management Protocol) allows a Auto-Configuration Server (ACS) to perform auto-configuration, provision, collection, and diagnostics to this device.

Figure 4-108

- **Inform:** You can select the checkbox to disable or enable the **Inform Interval**.
- **Inform Interval:** Type the interval time of your Router contact with the **ACS**.
- **ACS URL:** Please accept this information from your ISP. And through **ACS** (Auto-Configuration Server) you can perform auto-configuration, provision, collection, and diagnostics to this router.
- **ACS User Name:** Please accept this User Name information from your ISP.
- **ACS Password:** Please accept the Password information from your ISP.

Note:

If you want to log on the **ACS**, you must own the **ACS User Name** and **ACS Password**.

- **WAN Interface used by TR-069 Client:** Please select the WAN Interface from the drop-down list to perform this function.
- **Connection Request User Name:** Type the Connection Request User Name, set it yourself.
- **Connection Request Password:** Type the Connection Request Password, set it yourself.

Note:

The Connection Request User Name and Connection Request Password used for **ACS** log on the Router and manage it.

Select the desired values and click **Save/Apply** to configure the TR-069 client options.

4.7.5 Access Control

Choose “**Management**”→“**Access Control**”→“**Password**”, you can see the screen (shown in Figure 4-109) which allows you to change the factory default password of the Router. The default password is the same as the user name, which is admin/admin, support/support, and user/user respectively.

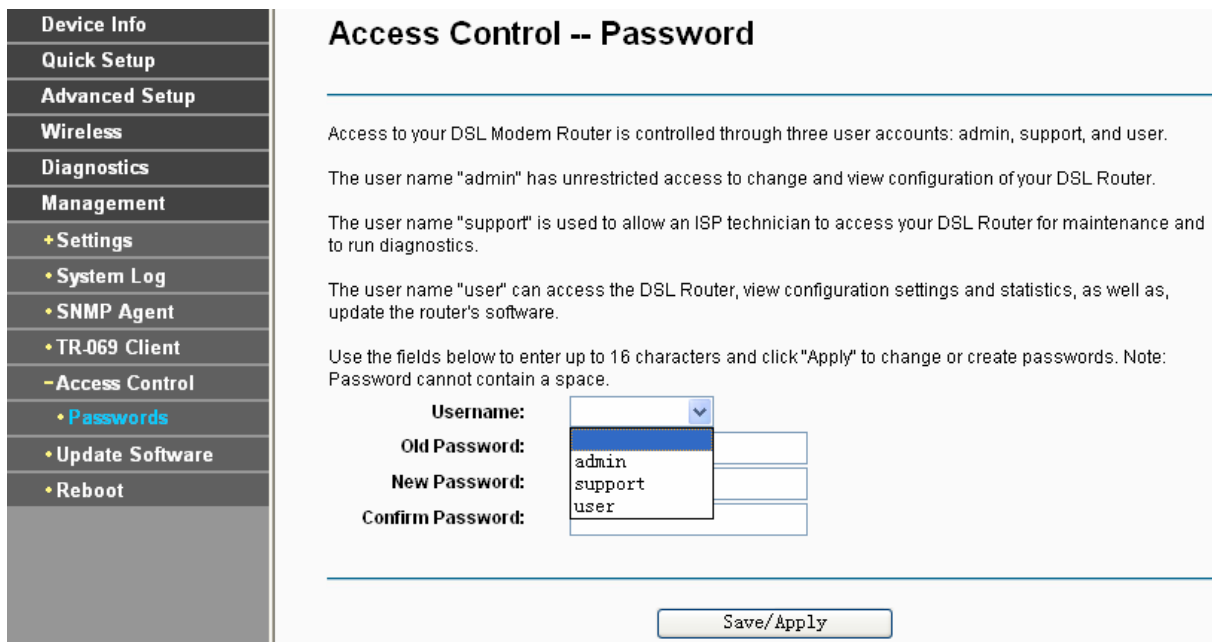

Figure 4-109

To change the password:

1. Select the **Username** whose password you want to change.
2. Enter the **Old Password** in the text box.
3. Enter the **New Password** and **Confirm Password**. The Confirm Password should be the same as the New Password.
4. Click **Save/Apply** to make your change take effect.

Note:

- 1) Access to your DSL Modem Router is controlled through three user accounts: admin, support, and user. The user name "admin" has unrestricted access to change and view configuration of your DSL Modem Router. The user name "support" is used to allow an ISP technician to

access your DSL Modem Router for maintenance and to run diagnostics. The user name "user" can access the DSL Modem Router, view configuration settings and statistics, as well as, update the Router's software.

- 2) Both of admin and support accounts can do remote management. For security reasons, please change the default password for these two accounts when remote access function is enabled.
- 3) The password cannot contain a space, and its maximum length is 16 characters.

4.7.6 Update Firmware

Choose "Management" → "Update Firmware", you can see the screen (shown in Figure 4-110) which allows you to upgrade the latest version software to keep the Router up to date.

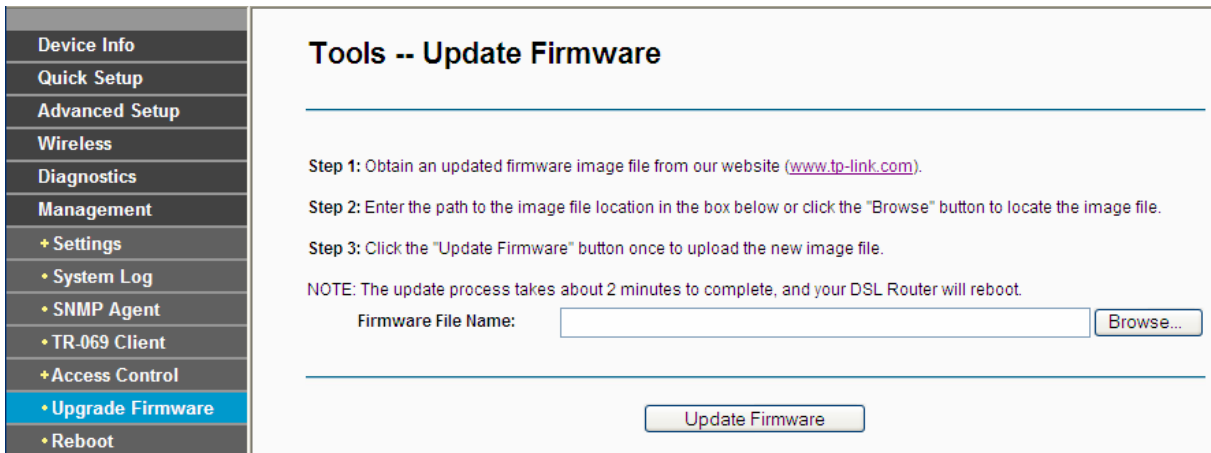

Figure 4-110

- **Browse:** Click the button to locate the latest software for the device.
- **Update Firmware:** After you have selected the latest software, click the button.

To update the Router's software:

1. Download the latest software upgrade file from the TP-LINK website (<http://www.tp-link.com>).
2. Click **Browse** to view the folders and select the image file or enter the exact path to the image file location in the text box.
3. Click the **Update Firmware** button.

Note:

- 1) There is no need to upgrade the firmware unless the new firmware has a new feature you want to use. However, when experiencing problems caused by the Router itself, you can try to upgrade the firmware.
- 2) Before upgrading the Router's firmware, you should write down some of your customized settings to avoid losing important configuration settings of the Router.
- 3) Do not turn off the Router or press the **Reset** button while the software is being updated.
- 4) The Router will reboot after the Upgrading is finished.

4.7.7 Reboot

Choose “**Management**”→“**Reboot**”, you can see the screen (shown in Figure 4-111) which allows you to reboot the Router.

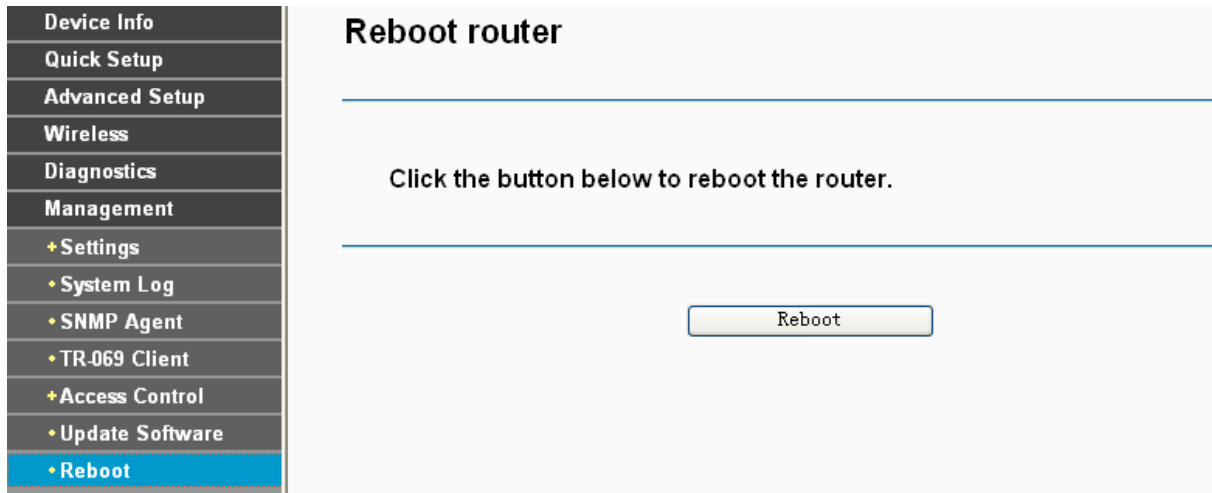

Figure 4-111

 **Note:**

- 1) After you clicked the **Reboot** button, please wait for a while before reopening your web browser.
- 2) Do not turn off the Router or press the **RESET** button while the Router is rebooting.
- 3) If necessary, reconfigure your PC's IP address to match your new configuration.

Appendix A: FAQ

1. How do I configure the Router to access Internet by ADSL users?

- 1) First, configure the ADSL Modem configured in RFC1483 bridge model.
- 2) Connect the Ethernet cable from your ADSL Modem to the WAN port on the Router. The telephone cord plugs into the Line port of the ADSL Modem.
- 3) Log in to the Router, and configure the WAN connection type as PPPoE connection mode. The detailed steps please refer to section 4.4.2.1 ATM-EoA-PPPoE.
- 4) If your ADSL lease is in “pay-according-time” mode, select “Dial on Demand” for Internet connection mode on the screen of Figure 4-10.

 **Note:**

If you are a Cable user, please configure the Router following the above steps.

2. How do I configure the Router to access Internet by Ethernet users?

Log in to the Router, and configure the WAN connection type as IPoE connection mode. The detailed steps please refer to section 4.4.2.2 ATM-EoA-IPoE.

3. I want to use NetMeeting, what do I need to do?

- 1) If you start NetMeeting as a sponsor, you don't need to do anything with the Router.
- 2) If you start as a response, you need to configure Virtual Server or DMZ Host.
- 3) How to configure Virtual Server: Log in to the Router, click the “**Advanced Setup-NAT**” menu on the left of your browser, and click “**Virtual Servers**” submenu. On the “**Virtual Servers**” page, click **Add**, and enter “1720” for the service port, using 192.168.1.222 for Server IP Address, remember to click the **Save/Apply** button.

- Device Info
- Quick Setup
- Advanced Setup
 - + Layer2 Interface
 - + WAN Service
 - + LAN
 - + MAC Clone
 - NAT
 - Virtual Servers
 - Port Triggering
 - DMZ Host
 - + Security
 - + Parental Control
 - + Quality of Service
 - + Traffic Control
 - + Routing
 - + DNS
 - + DSL
 - + UPnP
 - + Interface Grouping
 - + LAN Ports
 - + IPsec
- Wireless
- Diagnostics
- Management

NAT -- Virtual Servers

Select the service name, and enter the server IP address and click "Apply/Save" to forward IP packets for this service to the specified server.

NOTE: The "Internal Port End" cannot be modified directly. Normally, it is set to the same value as "External Port End". However, if you modify "Internal Port Start", then "Internal Port End" will be set to the same value as "Internal Port Start". Remaining number of entries that can be configured: 32

Use Interface:

Service Name:

Select a Service:

Custom Service:

Server IP Address:

External Port Start	External Port End	Protocol	Internal Port Start	Internal Port End
<input type="text" value="25"/>	<input type="text" value="25"/>	TCP <input type="button" value="v"/>	<input type="text" value="25"/>	<input type="text" value="25"/>
<input type="text"/>	<input type="text"/>	TCP <input type="button" value="v"/>	<input type="text"/>	<input type="text"/>
<input type="text"/>	<input type="text"/>	TCP <input type="button" value="v"/>	<input type="text"/>	<input type="text"/>
<input type="text"/>	<input type="text"/>	TCP <input type="button" value="v"/>	<input type="text"/>	<input type="text"/>
<input type="text"/>	<input type="text"/>	TCP <input type="button" value="v"/>	<input type="text"/>	<input type="text"/>
<input type="text"/>	<input type="text"/>	TCP <input type="button" value="v"/>	<input type="text"/>	<input type="text"/>
<input type="text"/>	<input type="text"/>	TCP <input type="button" value="v"/>	<input type="text"/>	<input type="text"/>
<input type="text"/>	<input type="text"/>	TCP <input type="button" value="v"/>	<input type="text"/>	<input type="text"/>
<input type="text"/>	<input type="text"/>	TCP <input type="button" value="v"/>	<input type="text"/>	<input type="text"/>
<input type="text"/>	<input type="text"/>	TCP <input type="button" value="v"/>	<input type="text"/>	<input type="text"/>
<input type="text"/>	<input type="text"/>	TCP <input type="button" value="v"/>	<input type="text"/>	<input type="text"/>
<input type="text"/>	<input type="text"/>	TCP <input type="button" value="v"/>	<input type="text"/>	<input type="text"/>
<input type="text"/>	<input type="text"/>	TCP <input type="button" value="v"/>	<input type="text"/>	<input type="text"/>
<input type="text"/>	<input type="text"/>	TCP <input type="button" value="v"/>	<input type="text"/>	<input type="text"/>
<input type="text"/>	<input type="text"/>	TCP <input type="button" value="v"/>	<input type="text"/>	<input type="text"/>

Note:

Your opposite side should call your WAN IP, which is displayed on the "Status" page.

- How to enable DMZ Host: Log in to the Router, click the "Advanced Setup-NAT" menu on the left of your browser, and click "DMZ Host" submenu. On the "DMZ" page, type your IP address into the "DMZ Host IP Address" field, using 192.168.1.222 as an example, remember to click the Save/Apply button.

- Device Info
- Quick Setup
- Advanced Setup
 - + Layer2 Interface
 - + WAN Service
 - + LAN
 - + MAC Clone
 - NAT
 - Virtual Servers
 - Port Triggering
 - DMZ Host
 - + Security
 - + Parental Control
 - + Quality of Service

NAT -- DMZ Host

The DSL Modem Router will forward IP packets from the WAN that do not belong to any of the applications configured in the Virtual Servers table to the DMZ host computer.

Enter the computer's IP address and click "Save/Apply" to activate the DMZ host.

Clear the IP address field and click "Apply" to deactivate the DMZ host.

DMZ Host IP Address:

4. I want to build a WEB Server on the LAN, what should I do?

Log in to the Router, click the "Advanced Setup-NAT" menu on the left of your browser, and click

the "Virtual Servers" submenu. On the "Virtual Servers" page, click **Add New**, then on the "Add or Modify a Virtual Server" page, enter use "80" as service port, and your IP address next to the "Server IP Address", assuming 192.168.1.188 for an example, and remember to click the **Save/Apply** button.

Note:

Because the WEB Server port 80 will interfere with the WEB management port 80 on the Router, you will be prompted to change the WEB management port number to avoid interference.

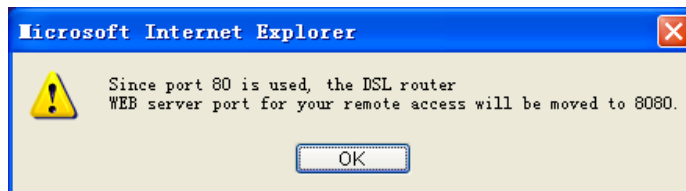

5. The wireless stations cannot connect to the Router.

- 1) Make sure the "Enable Wireless Router Radio" is checked.
- 2) Make sure that the wireless stations' SSID accord with the Router's SSID.
- 3) Make sure the wireless stations have right KEY for encryption when the Router is encrypted.
- 4) If the wireless connection is ready, but you can't access the Router, check the IP Address of your wireless stations.

Appendix B: Configuring the PC

For Windows XP OS

Go to **Start > Control Panel**, you will then see the following page.

Click **Network and Internet Connections**

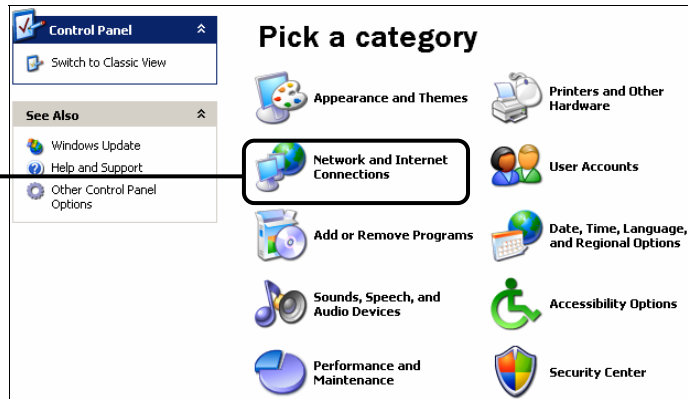

Click **Network Connections**

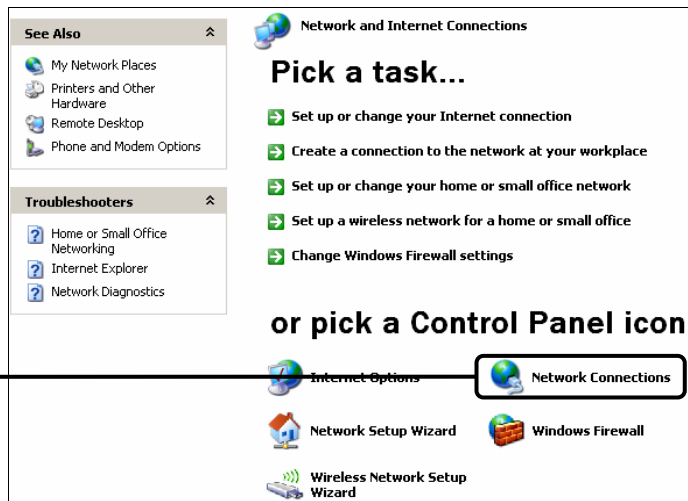

Right-click **Local Area Connection**

Click **Properties**

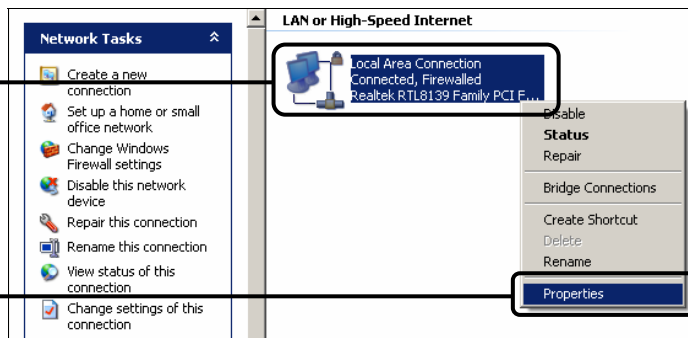

Double-click **Internet Protocol (TCP/IP)**

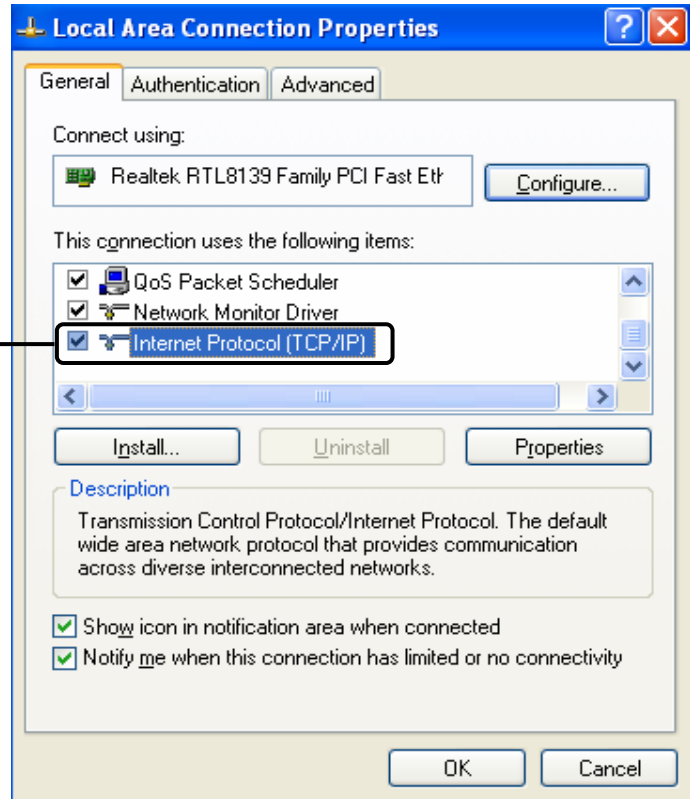

Select **Obtain an IP address automatically**

Select **Obtain DNS server address automatically**

Click **OK**

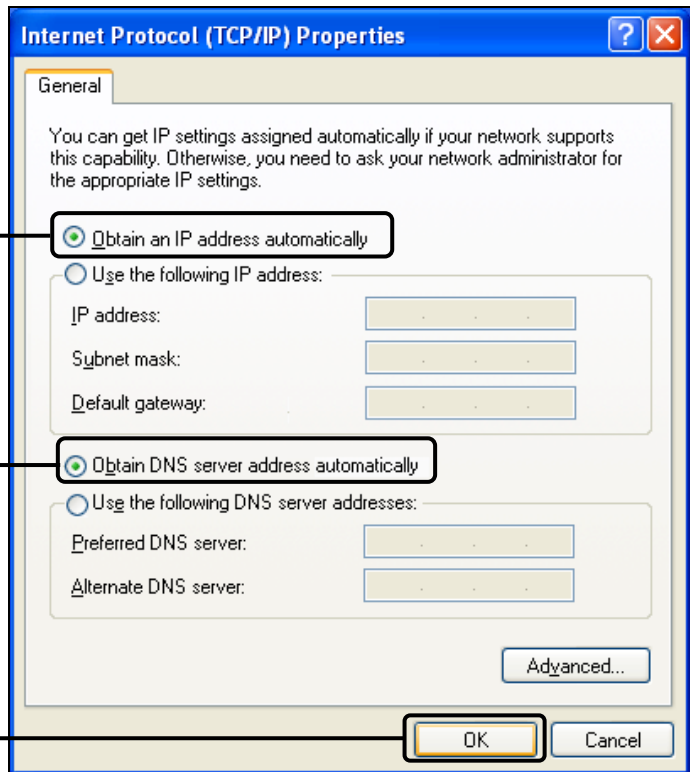

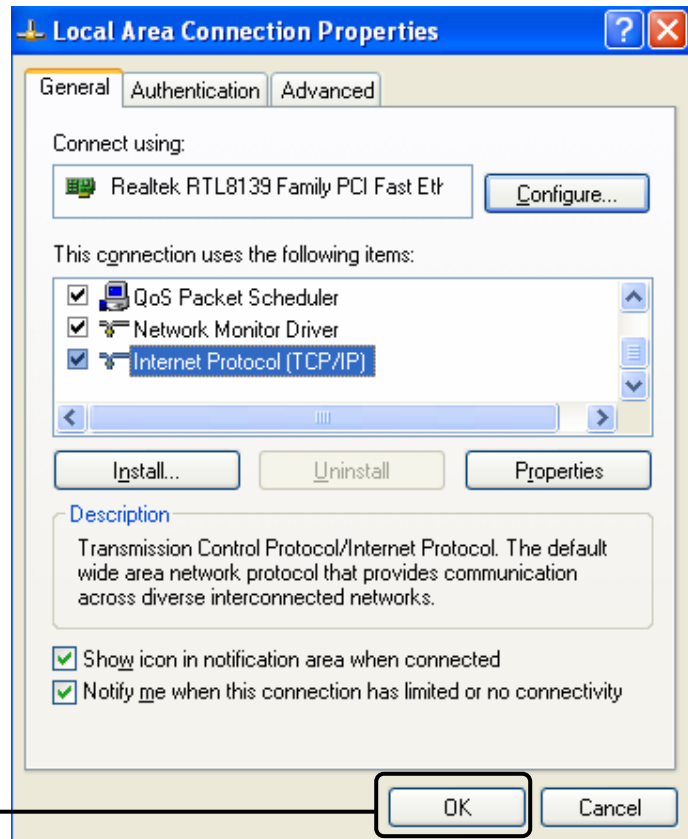

For Windows Vista OS

Go to **Start > Settings > Control Panel**, and then you will see the following page.

Click **View network status and tasks**

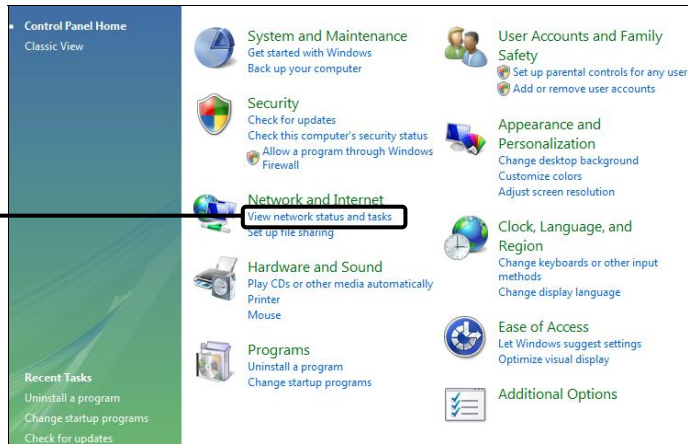

Click **View status**

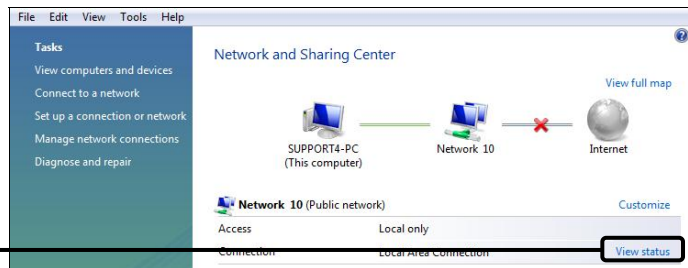

Click **Properties**

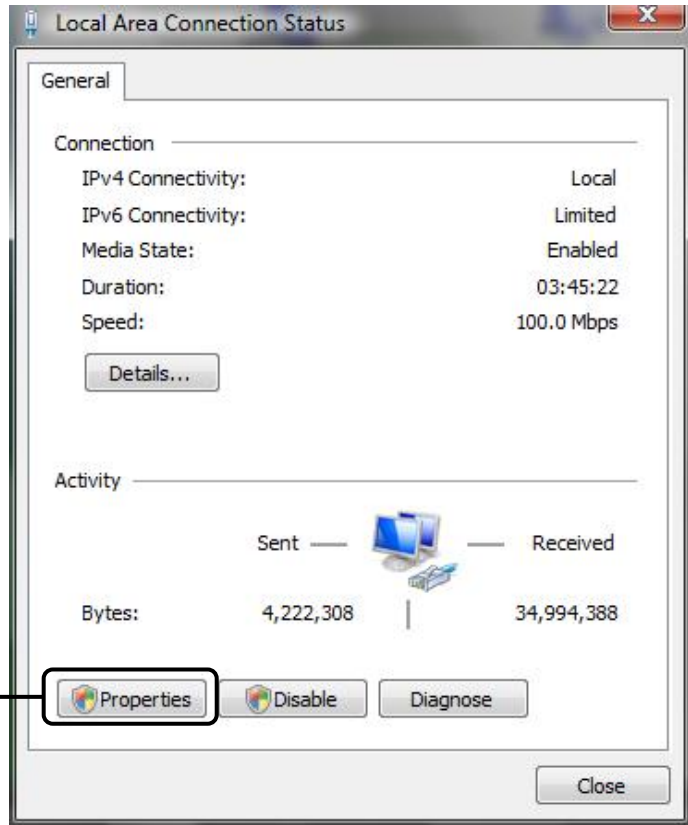

Double-click **Internet Protocol Version 4 (TCP/IPv4)**

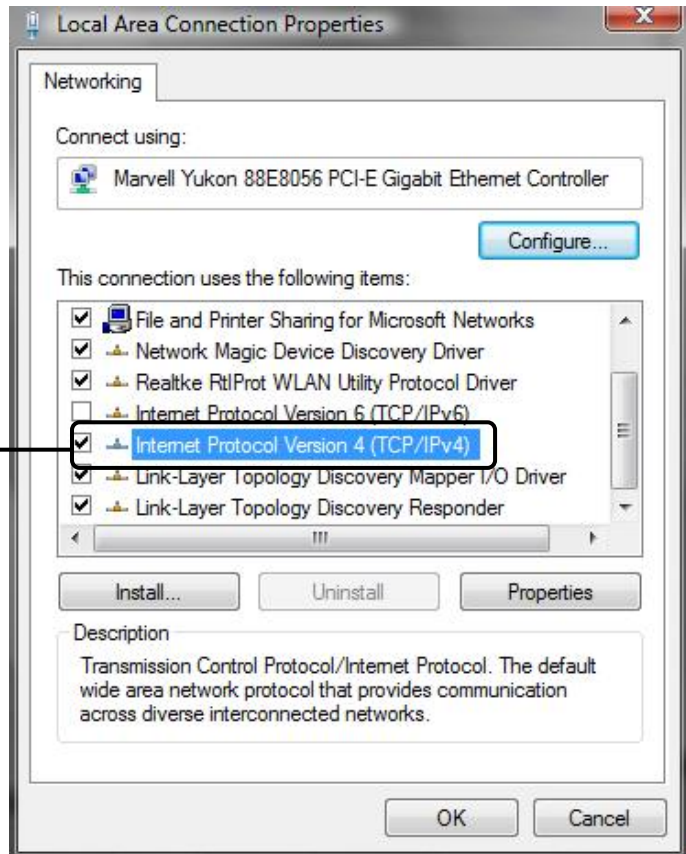

Select **Obtain an IP address automatically**

Select **Obtain DNS server address automatically**

Click **OK**

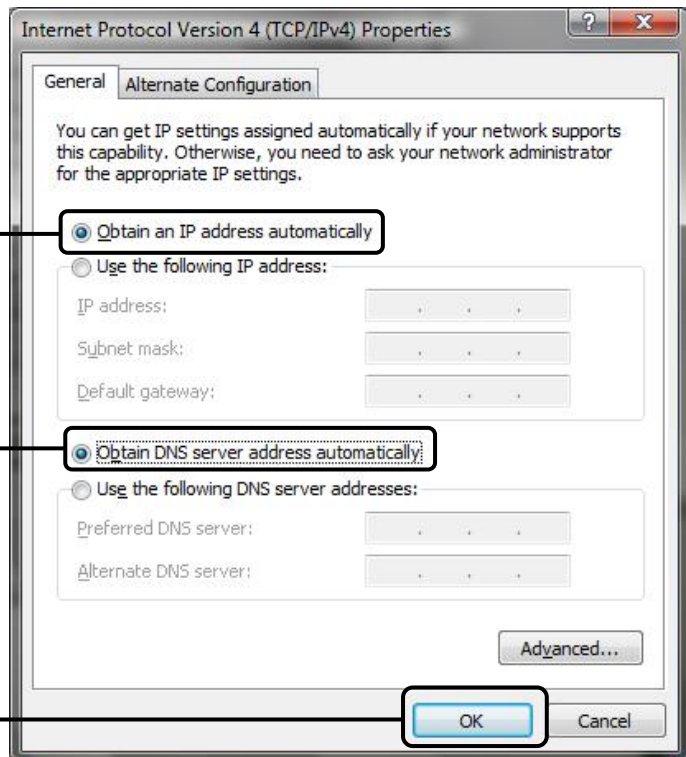

For Windows 7 OS

Go to **Start > Settings > Control Panel**, and then you will see the following page.

Click **View network status and tasks**

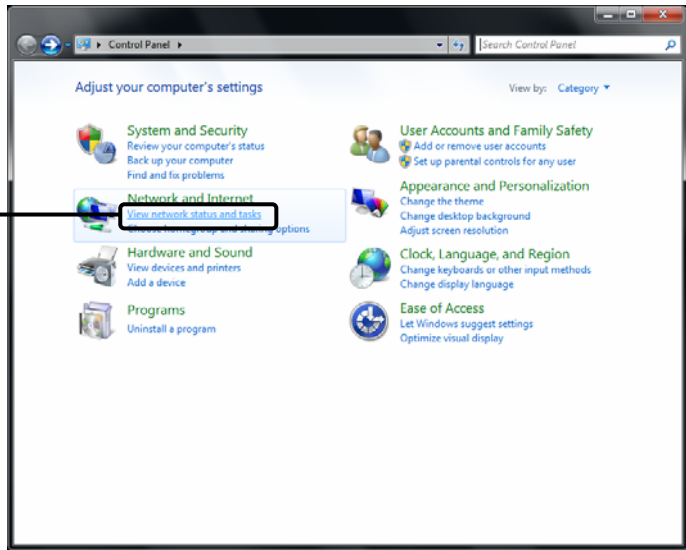

Click **Change adapter settings**

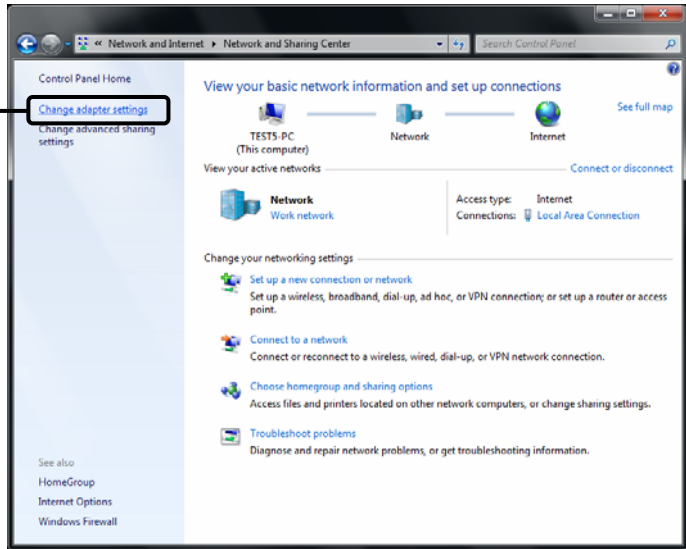

Right-click **Local Area Connection**

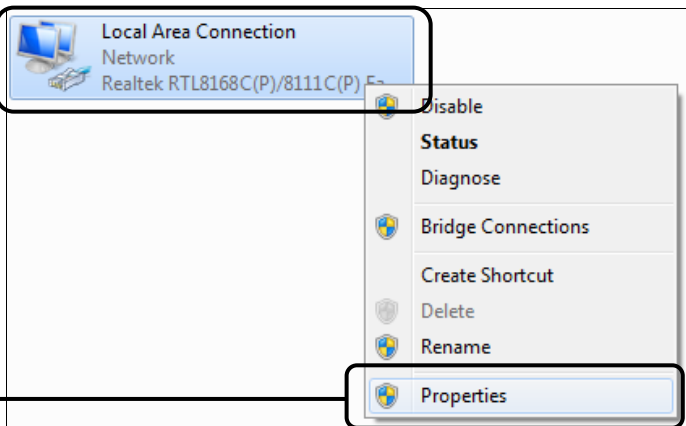

Click **Properties**

Double-click **Internet Protocol Version 4 (TCP/IPv4)**

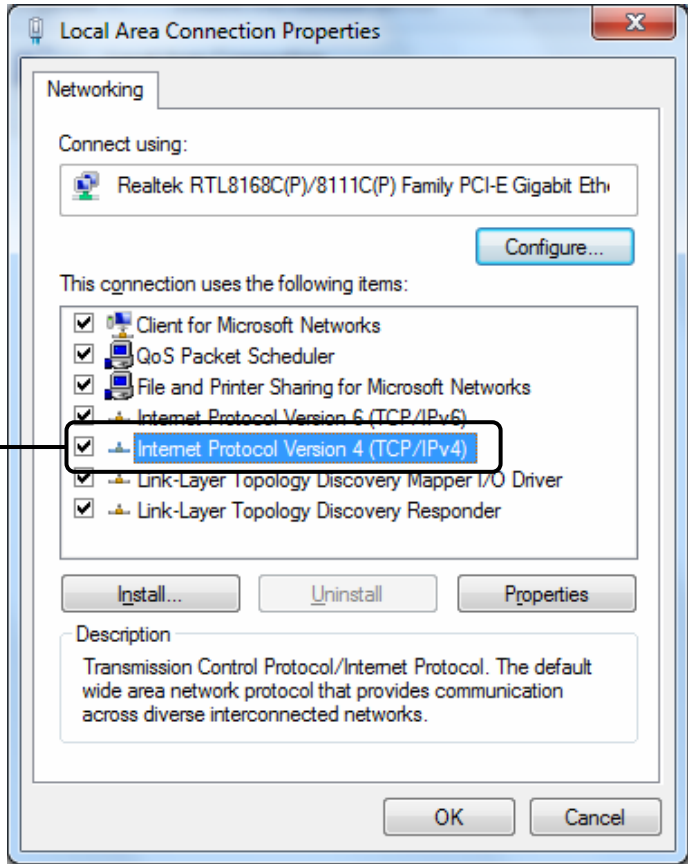

Select **Obtain an IP address automatically**

Select **Obtain DNS server address automatically**

Click **OK**

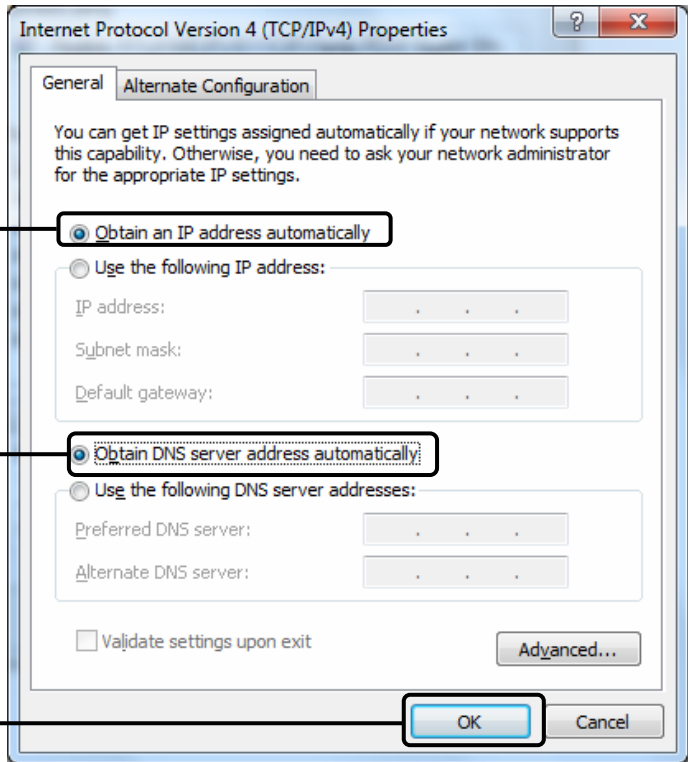

Appendix C: Specifications

General	
Standards	ANSI T1.413, ITU G.992.1, ITU G.992.2, ITU G.992.3, ITU G.992.5, IEEE 802.3, IEEE 802.3u, IEEE 802.11b , IEEE 802.11g , 802.11n
Protocols	TCP/IP, IPoA , PPPoA , PPPoE, SNTP, HTTP, DHCP, ICMP, NAT
Ports	LAN Ports: Four 10/100M Auto-Negotiation RJ45 ports (Auto MDI/MDIX)
	Line Port: One RJ11 port
Cabling Type	10BASE-T: UTP category 3, 4, 5 cable (maximum 100m) EIA/TIA-568 100Ω STP (maximum 100m)
	100BASE-TX: UTP category 5, 5e cable (maximum 100m) EIA/TIA-568 100Ω STP (maximum 100m)
LED	1,2,3,4(LAN), WLAN, ADSL
	Power, Internet, QSS
Safety & Emissions	FCC, CE

Wireless	
Frequency Band	2.4~2.4835GHz
Radio Data Rate	11n: up to 300Mbps (Automatic) 11g: 54/48/36/24/18/12/9/6Mbps (Automatic) 11b: 11/5.5/2/1Mbps (Automatic)
Frequency Expansion	DSSS(Direct Sequence Spread Spectrum)
Modulation	DBPSK, DQPSK, CCK, OFDM, 16-QAM, 64-QAM
Security	WEP/WPA/WPA2/WPA2-PSK/WPA-PSK
Sensitivity @PER	270M: -62dBm@10% PER 130M: -64dBm@10% PER 54M: -68dBm@10% PER 11M: -85dBm@8% PER 6M: -88dBm@10% PER 1M: -90dBm@8% PER

Environmental and Physical	
Temperature.	Operating: 0°C~40°C (32°F~104°F)
	Storage: -40°C~70°C(-40°F~158°F)
Humidity	Operating: 10% ~ 90% RH, Non-condensing
	Storage: 5% ~ 90% RH, Non-condensing

Appendix D: Glossary

- **802.11n** - 802.11n builds upon previous 802.11 standards by adding MIMO (multiple-input multiple-output). MIMO uses multiple transmitter and receiver antennas to allow for increased data throughput via spatial multiplexing and increased range by exploiting the spatial diversity, perhaps through coding schemes like Alamouti coding. The Enhanced Wireless Consortium (EWC) [3] was formed to help accelerate the IEEE 802.11n development process and promote a technology specification for interoperability of next-generation wireless local area networking (WLAN) products.
- **802.11b** - The 802.11b standard specifies a wireless networking at 11 Mbps using direct-sequence spread-spectrum (DSSS) technology and operating in the unlicensed radio spectrum at 2.4GHz, and WEP encryption for security. 802.11b networks are also referred to as Wi-Fi networks.
- **802.11g** - specification for wireless networking at 54 Mbps using direct-sequence spread-spectrum (DSSS) technology, using OFDM modulation and operating in the unlicensed radio spectrum at 2.4GHz, and backward compatibility with IEEE 802.11b devices, and WEP encryption for security.
- **2x to 3x eXtended Range™ WLAN Transmission Technology** - The WLAN device with 2x to 3x eXtended Range™ WLAN transmission technology make its sensitivity up to 105 dB, which gives users the ability to have robust, longer-range wireless connections. With this range-enhancing technology, a 2x to 3x eXtended Range™ based client and access point can maintain a connection at as much as three times the transmission distance of traditional 802.11b and 802.11g products, for a coverage area that is up to nine times greater. A traditional 802.11b and 802.11g product transmission distance is about 300m, a 2x to 3x eXtended Range™ based client and access point can maintain a connection transmission distance may be up to 830m.
- **Access Point** - A device that allows wireless-equipped computers and other devices to communicate with a wired network. Also used to expand the range of a wireless network.
- **Ad-hoc Network** - An ad-hoc network is a group of computers, each with a wireless adapter, connected as an independent IEEE 802.11 wireless LAN. Ad-hoc wireless computers operate on a peer-to-peer basis, communicating directly with each other without the use of an access point. Ad-hoc mode is also referred to as an Independent Basic Service Set (IBSS) or as peer-to-peer mode, and is useful at a departmental scale or SOHO operation.
- **AES (Advanced Encryption Standard)** - A security method that uses symmetric 128-bit block data encryption.
- **ACS (Auto-Configuration Server)** - Through **ACS** (Auto-Configuration Server) you can perform auto-configuration, provision, collection, and diagnostics to the device.
- **ATM (Asynchronous Transfer Mode)** - ATM is a cell based transfer mode that requires variable length user information to be segmented and reassembled to/from short, fixed length cells. It uses two different methods for carrying connectionless network interconnect traffic, routed and bridged Protocol Data Units (PDUs), over an ATM network.
- **Bridging** - A device that connects different networks.
- **Browser** - An application program that provides a way to look at and interact with all the information on the World Wide Web.

- **DDNS (Dynamic Domain Name System)** - Allows the hosting of a website, FTP server, or e-mail server with a fixed domain name (e.g., www.xyz.com) and a dynamic IP address.
- **Default Gateway** - A device that forwards Internet traffic from your local area network.
- **DHCP** - A networking protocol that allows administrators to assign temporary IP addresses to network computers by “leasing” an IP address to a user for a limited amount of time, instead of assigning permanent IP addresses.
- **DMZ (Demilitarized Zone)** - Removes the Router's firewall protection from one PC, allowing it to be “seen” from the Internet.
- **DNS (Domain Name Server)** - The IP address of your ISP's server, which translates the names of websites into IP addresses.
- **Domain** - A specific name for a network of computers.
- **DSL (Digital Subscriber Line)** - An always-on broadband connection over traditional phone lines.
- **Dynamic IP Address** - A temporary IP address assigned by a DHCP server.
- **EAP (Extensible Authentication Protocol)** - A general authentication protocol used to control network access. Many specific authentication methods work within this framework.
- **Encryption** - Encoding data transmitted in a network.
- **Ethernet** - IEEE standard network protocol that specifies how data is placed on and retrieved from a common transmission medium.
- **Firewall** - A set of related programs located at a network gateway server that protects the resources of a network from users from other networks.
- **Gateway** - A device that interconnects networks with different, incompatible communications protocols.
- **IEEE 802.11b** - The IEEE 802.11b standard specifies a wireless networking at 11 Mbps using direct-sequence spread-spectrum (DSSS) technology and operating in the unlicensed radio spectrum at 2.4GHz, and WEP encryption for security. IEEE 802.11b networks are also referred to as Wi-Fi networks.
- **IEEE 802.11g** - Specification for wireless networking at 54 Mbps using direct-sequence spread-spectrum (DSSS) technology, using OFDM modulation and operating in the unlicensed radio spectrum at 2.4GHz, and backward compatibility with IEEE 802.11b devices, and WEP encryption for security.
- **Infrastructure Network** - An infrastructure network is a group of computers or other devices, each with a wireless adapter, connected as an IEEE 802.11 wireless LAN. In infrastructure mode, the wireless devices communicate with each other and to a wired network by first going through an access point. An infrastructure wireless network connected to a wired network is referred to as a Basic Service Set (BSS). A set of two or more BSS in a single network is referred to as an Extended Service Set (ESS). Infrastructure mode is useful at a corporation scale, or when it is necessary to connect the wired and wireless networks.
- **IP Address** - The address used to identify a computer or device on a network.
- **IPoA (IP and ARP over ATM)** - A protocol that provides extensions to the IP Group for handling IP over ATM flows.
- **ISP (Internet Service Provider)** - A company that provides access to the Internet.

- **LAN** - The computers and networking products that make up your local network.
- **MAC (Media Access Control) Address** - The unique address that a manufacturer assigns to each networking device.
- **NAT (Network Address Translation)** - NAT technology translates IP addresses of a local area network to a different IP address for the Internet.
- **MER (MAC Encapsulation Routing)** - **MER** allows IP packet to be carried as bridged frames. There are many applications, such as IPoA, DSL networks and other frame-based network. Depending on your equipment, they can be either bridged or routed within the network.
- **Network** - A series of computers or devices connected for the purpose of data sharing, storage, and/or transmission between users.
- **Ping (Packet Internet Groper)** - An Internet utility used to determine whether a particular IP address is online.
- **Port** - The connection point on a computer or networking device used for plugging in cables or adapters.
- **PPPoE (Point to Point Protocol over Ethernet)** - PPPoE stands for Point to Point protocol over Ethernet, this protocol is used as a type of broadband connection that provides authentication (username and password) in addition to data transport.
- **PPPoA (Point to Point Protocol over ATM)** - PPPoA stands for Point to Point protocol over ATM, this protocol is also used as a type of broadband connection that provides authentication (username and password) in addition to data transport.
- **RADIUS (Remote Authentication Dial-In User Service)** - A protocol that uses an authentication server to control network access.
- **RJ45 (Registered Jack-45)** - An Ethernet connector that holds up to eight wires.
- **Router** - A networking device that connects multiple networks together.
- **RPC (Remote Procedure Calls)** - RPC is a powerful technique for constructing distributed, client-server based applications. It is based on extending the notion of convention, or local procedure calling, so that the called procedure need not exist in the same address space as the calling procedure. The two processes may be on the same system, or they may be on different systems with a network connecting them. By using RPC, programmers of distributed applications avoid the details of the interface with the network. The transport independence of RPC isolates the application from the physical and logical elements of the data communications mechanism and allows the application to use a variety of transports.
- **Server** - Any computer whose function in a network is to provide user access to files, printing, communications, and other services.
- **SOHO (Small Office/Home Office)** - Market segment of professionals who work at home or in small offices.
- **SSID** - A Service Set Identification is a thirty-two character (maximum) alphanumeric key identifying a wireless local area network. For the wireless devices in a network to communicate with each other, all devices must be configured with the same SSID. This is typically the configuration parameter for a wireless PC card. It corresponds to the ESSID in the wireless Access Point and to the wireless network name.
- **Static IP Address** - A fixed address assigned to a computer or device that is connected to a network.

- **Static Routing** - Forwarding data in a network via a fixed path.
- **Subnet Mask** - An address code that determines the size of the network.
- **TCP (Transmission Control Protocol)** - A network protocol for transmitting data that requires acknowledgement from the recipient of data sent.
- **TCP/IP (Transmission Control Protocol/Internet Protocol)** - A set of instructions PCs use to communicate over a network.
- **TKIP (Temporal Key Integrity Protocol)** - a wireless encryption protocol that provides dynamic encryption keys for each packet transmitted.
- **UDP (User Datagram Protocol)** - A network protocol for transmitting data that does not require acknowledgement from the recipient of the data that is sent.
- **VCI (Virtual Channel Identifier)** - The identifier of the VC contained in the ATM cell header.
- **VPI (Virtual Path Identifier)** - The identifier of the VP contained in the ATM cell header.
- **Update** - To replace existing software or firmware with a newer version.
- **VLAN (Virtual Local Air Network)** - Logical subgroups that constitute a Local Area Network (LAN). This is done in software rather than defining a hardware solution.
- **VLAN ID (0-4095)** - Indicates the ID number of the VLAN being configured. Up to 256 VLANs can be created.
- **WAN (Wide Area Network)** - Networks that cover a large geographical area.
- **Web-based Utility** - The web page that allows you to manage the Router.
- **WEP (Wired Equivalent Privacy)** - A data privacy mechanism based on a 64-bit or 128-bit or 152-bit shared key algorithm, as described in the IEEE 802.11g standard.
- **Wi-Fi** - A trade name for the IEEE 802.11b wireless networking standard, given by the Wireless Ethernet Compatibility Alliance (WECA, see <http://www.wi-fi.net>), an industry standards group promoting interoperability among IEEE 802.11b devices.
- **WLAN (Wireless Local Area Network)** - A group of computers and associated devices communicate with each other wirelessly, which network serving users are limited in a local area.
- **WPA (Wi-Fi Protected Access)** - A wireless security protocol use TKIP (Temporal Key Integrity Protocol) encryption, which can be used in conjunction with a RADIUS server.

Appendix E: Technical Support

Technical Support

- For more troubleshooting help, go to:
www.tp-link.com/support/faq.asp
- To download the latest Firmware, Driver, Utility and User Guide, go to:
www.tp-link.com/support/download.asp
- For all other technical support, please contact us by using the following details:

Global

Tel: +86 755 26504400
E-mail: support@tp-link.com
Service time: 24hrs, 7 days a week

Singapore

Tel: +65 62840493
E-mail: support.sg@tp-link.com
Service time: 24hrs, 7 days a week

UK

Tel: +44 (0) 845 147 0017
E-mail: support.uk@tp-link.com
Service time: 24hrs, 7 days a week

USA/Canada

Toll Free: +1 866 225 8139
E-mail: support.usa@tp-link.com
Service time: 24hrs, 7 days a week

Germany / Austria

Tel: +49 1805 875465 (German Service) / +49 1805 TPLINK
E-mail: support.de@tp-link.com
Fee: 0.14 EUR/min from the German fixed phone network and up to 0.42 EUR/min from mobile phone
Service time: Monday to Friday 9:00 AM to 6:00 PM GMT+ 1 or GMT+ 2 (Daylight Saving Time in Germany)

*Except bank holidays in Hesse

Australia & New Zealand

Tel: AU 1300 87 5465
NZ 0800 87 5465
E-mail: support@tp-link.com.au
Service time: 24hrs, 7 days a week

Malaysia

Tel: 1300 88 875465 (1300 88TPLINK)
Email: support.my@tp-link.com
Service time: 24hrs, 7 days a week

Turkey

Tel: 444 19 25 (Turkish Service)
E-mail: support.tr@tp-link.com
Service time: 9:00 AM to 6:00 PM 7 days a week

Italy

Tel: +39 02 66987799
E-mail: support.it@tp-link.com
Service time: 9:00 AM to 6:00 PM Monday to Friday

Switzerland

Tel: +41 (0)848 800998 (German Service)
E-mail: support.ch@tp-link.com
Fee: 4-8 Rp/min, depending on rate of different time
Service time: Monday to Friday 9:00 AM to 6:00 PM GMT+ 1 or GMT+ 2 (Daylight Saving Time)