



**IGR-1500**

Four-WAN Internet Gateway

**User's Manual**



[www.airlive.com](http://www.airlive.com)

# Declaration of Conformity

We, Manufacturer/Importer  
**OvisLink Corp.**  
**5F., NO.6, Lane 130, Min-Chuan Rd.,**  
**Hsin-Tien City, Taipei County, Taiwan**

Declare that the product  
**Four-WAN Internet Gateway**  
**IGR-1500**  
**is in conformity with**

In accordance with 89/336 EEC-EMC Directive and 1999/5 EC-R & TTE Directive

<u>Clause</u>	<u>Description</u>
■ EN 55022:1998/A1 :2000/A2:2003	Limits and methods of measurement of radio disturbance characteristics of information technology equipment
■ EN 61000-3-2:2000	Disturbances in supply systems caused by household appliances and similar electrical equipment "Harmonics"
■ EN 61000-3-3:1995/ A1:2001	Disturbances in supply systems caused by household appliances and similar electrical equipment "Voltage fluctuations"
■ EN 55024:1998/A1 :2001/A2:2003	Information Technology equipment-Immunity characteristics-Limits And methods of measurement
■ CE marking	

Manufacturer/Importer

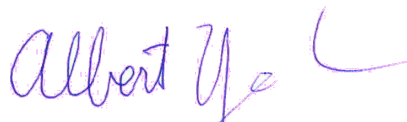

Signature :  
Name :  
Position/ Title :

Albert Yeh  
Vice President

Date : 2007/8/23

(Stamp)

## AirLive IGR-1500 CE Declaration Statement

Country	Declaration	Country	Declaration
<b>cs</b> Česky [Czech]	OvisLink Corp. tímto prohlašuje, že tento AirLive IGR-1500 je ve shodě se základními požadavky a dalšími příslušnými ustanoveními směrnice 1999/5/ES.	<b>lt</b> Lietuvių [Lithuanian]	Šiuo OvisLink Corp. deklaruoja, kad šis AirLive IGR-1500 atitinka esminius reikalavimus ir kitas 1999/5/EB Direktyvos nuostatas.
<b>da</b> Dansk [Danish]	Undertegnede OvisLink Corp. erklærer herved, at følgende udstyr AirLive IGR-1500 overholder de væsentlige krav og øvrige relevante krav i direktiv 1999/5/EF.	<b>nl</b> Nederlands [Dutch]	Hierbij verklaart OvisLink Corp. dat het toestel AirLive IGR-1500 in overeenstemming is met de essentiële eisen en de andere relevante bepalingen van richtlijn 1999/5/EG.
<b>de</b> Deutsch [German]	Hiermit erkläre OvisLink Corp., dass sich das Gerät AirLive IGR-1500 in Übereinstimmung mit den grundlegenden Anforderungen und den übrigen einschlägigen Bestimmungen der Richtlinie 1999/5/EG befindet.	<b>mt</b> Malti [Maltese]	Hawnhekk, OvisLink Corp, jiddikjara li dan AirLive IGR-1500 jikkonforma mal-htigijiet essenzjali u ma provvedimenti oħrajn rilevanti li hemm fid-Dirrettiva 1999/5/EC.
<b>et</b> Eesti [Estonian]	Käesolevaga kinnitab OvisLink Corp. seadme AirLive IGR-1500 vastavust direktiivi 1999/5/EÜ põhinõuetele ja nimetatud direktiivist tulenevatele teistele asjakohastele sätetele.	<b>hu</b> Magyar [Hungarian]	Az OvisLink Corporation kijelenti, hogy az AirLive IGR-1500 megfelel az 1999/05/CE irányelv alapvető követelményeinek és egyéb vonatkozó rendelkezéseinek.
<b>en</b> English	Hereby, OvisLink Corp., declares that this AirLive IGR-1500 is in compliance with the essential requirements and other relevant provisions of Directive 1999/5/EC.	<b>pl</b> Polski [Polish]	Niniejszym OvisLink Corp oświadcza, że AirLive IGR-1500 jest zgodny z zasadniczymi wymogami oraz pozostałymi stosownymi postanowieniami Dyrektywy 1999/5/EC.
<b>es</b> Español [Spanish]	Por medio de la presente OvisLink Corp. declara que el AirLive IGR-1500 cumple con los requisitos esenciales y cualesquiera otras disposiciones aplicables o exigibles de la Directiva 1999/5/CE.	<b>pt</b> Português [Portuguese]	OvisLink Corp declara que este AirLive IGR-1500 está conforme com os requisitos essenciais e outras disposições da Directiva 1999/5/CE.
<b>el</b> Ελληνική [Greek]	ΜΕ ΤΗΝ ΠΑΡΟΥΣΑ OvisLink Corp. ΔΗΛΩΝΕΙ ΟΤΙ AirLive IGR-1500 ΣΥΜΜΟΡΦΩΝΕΤΑΙ ΠΡΟΣ ΤΙΣ ΟΥΣΙΩΔΕΙΣ ΑΠΑΙΤΗΣΕΙΣ ΚΑΙ ΤΙΣ ΛΟΙΠΕΣ ΣΧΕΤΙΚΕΣ ΔΙΑΤΑΞΕΙΣ ΤΗΣ ΟΔΗΓΙΑΣ 1999/5/ΕΚ.	<b>sl</b> Slovensko [Slovenian]	OvisLink Corp izjavlja, da je ta AirLive IGR-1500 v skladu z bistvenimi zahtevami in ostalimi relevantnimi določili direktive 1999/5/ES.
<b>fr</b> Français [French]	Par la présente OvisLink Corp. déclare que l'appareil AirLive IGR-1500 est conforme aux exigences essentielles et aux autres dispositions pertinentes de la directive 1999/5/CE	<b>sk</b> Slovensky [Slovak]	OvisLink Corp týmto vyhlasuje, že AirLive IGR-1500 spĺňa základné požiadavky a všetky príslušné ustanovenia Smernice 1999/5/ES.
<b>it</b> Italiano [Italian]	Con la presente OvisLink Corp. dichiara che questo AirLive IGR-1500 è conforme ai requisiti essenziali ed alle altre disposizioni pertinenti stabilite dalla direttiva 1999/5/CE.	<b>fi</b> Suomi [Finnish]	OvisLink Corp vakuuttaa täten että AirLive IGR-1500 tyyppinen laite on direktiivin 1999/5/EY oleellisten vaatimusten ja sitä koskevien direktiivin muiden ehtojen mukainen
<b>lv</b> Latviski [Latvian]	Ar šo OvisLink Corp. deklarē, ka AirLive IGR-1500 atbilst Direktīvas 1999/5/EK būtiskajām prasībām un citiem ar to saistītajiem noteikumiem.	<b>is</b> Íslenska [Icelandic]	Hér með lýsir OvisLink Corp yfir því að AirLive IGR-1500 er í samræmi við grunnkröfur og aðrar kröfur, sem gerðar eru í tilskipun 1999/5/EC.
<b>sv</b> Svenska [Swedish]	Härmed intygar OvisLink Corp. att denna AirLive IGR-1500 står i överensstämmelse med de väsentliga egenskapskrav och övriga relevanta bestämmelser som framgår av direktiv 1999/5/EG.	<b>no</b> Norsk [Norwegian]	OvisLink Corp erklærer herved at utstyret AirLive IGR-1500 er i samsvar med de grunnleggende krav og øvrige relevante krav i direktiv 1999/5/EF.

A copy of the full CE report can be obtained from the following address:

**OvisLink Corp.**  
**5F, No.6 Lane 130,**  
**Min-Chuan Rd, Hsin-Tien City,**  
**Taipei, Taiwan, R.O.C.**

This equipment may be used in AT, BE, CY, CZ, DK, EE, FI, FR, DE, GR, HU, IE, IT, LV, LT, LU, MT, NL, PL, PT, SK, SI, ES, SE, GB, IS, LI, NO, CH, BG, RO, TR

## **Copyright**

The contents of this publication may not be reproduced in any part or as a whole, stored, transcribed in an information retrieval system, translated into any language, or transmitted in any form or by any means, mechanical, magnetic, electronic, optical, photocopying, manual, or otherwise, without the prior written permission.

## **Trademarks**

All products, company, brand names are trademarks or registered trademarks of their respective companies. They are used for identification purpose only. Specifications are subject to be changed without prior notice.

## **FCC Interference Statement**

The **IGR-1500** has been tested and found to comply with the limits for a Class B digital device pursuant to Part 15 of the FCC Rules. These limits are designed to provide reasonable protection against radio interference in a commercial environment. This equipment can generate, use and radiate radio frequency energy and, if not installed and used in accordance with the instructions in this manual, may cause harmful interference to radio communications. Operation of this equipment in a residential area is likely to cause interference, in which case the user, at his own expense, will be required to take whatever measures are necessary to correct the interference.

## **CE Declaration of Conformity**

This equipment complies with the requirements relating to electromagnetic compatibility, EN 55022/A1/A2, EN 61000-3-2, EN 61000-3-3/A1, EN 55024/A1/A2, Class B.

**The specification is subject to change without notice.**

# Table of Contents

<b>Chapter 1 Introduction</b> .....	<b>4</b>
1.1 Functions and Features .....	4
1.2 Front Panel and Rear Panel .....	5
1.3 Packing List.....	6
<b>Chapter 2 Deployment</b> .....	<b>7</b>
<b>Chapter 3 Configure Router</b> .....	<b>8</b>
3.1 How to start out to configure router .....	8
3.2 Work Mode.....	11
3.3 System Status .....	13
3.3.1 Link Status.....	13
3.3.2 Data Monitor .....	14
3.4 WAN Configure .....	16
3.4.1 WAN Type – Dynamic IP .....	17
3.4.2 WAN Type – PPPoE.....	18
3.4.3 WAN Type – Static IP .....	19
3.5 Bandwidth Usage.....	20
3.6 Configure LAN & DHCP .....	22
3.7 Routing Table .....	24
3.7.1 Configure.....	24
3.7.2 Current Table.....	26
3.8 Access Control .....	27
3.8.1 Local IP Filtering (Gateway Mode only) .....	27
3.8.2 Remote IP Filtering (Gateway Mode only) .....	29
3.8.3 Intrusion Security (Gateway Mode only) .....	30
3.8.4 DoS Defense (Gateway Mode only).....	31
3.8.5 URL Filtering (Gateway Mode only) .....	33
3.9 QoS .....	34
3.10 Load Balance .....	35
3.10.1 Outbound Load Balance .....	35
3.10.2 Inbound Load Balance .....	37
3.10.3 Special Application .....	38
3.10.4 Special IP Assignment.....	38
3.10.5 TOS .....	39
3.11 Advance.....	40
3.11.1 Remote Configure .....	40
3.11.2 Virtual Server .....	41
3.11.3 DMZ Host .....	45
3.11.4 Multi-NAT .....	47

3.11.5 IP Binding .....	48
3.11.6 DDNS (Gateway mode and Basic NAT mode only) .....	50
3.11.7 Proxy (Gateway mode and Basic NAT mode only) .....	51
3.11.8 Mail Alert (Gateway mode and Basic NAT mode only).....	52
3.11.9 Time (Gateway mode and Basic NAT mode only).....	53
3.11.10 System Log (Gateway mode and Basic NAT mode only) .....	54
3.11.11 MAC Address Clone .....	55
3.12 Administrator .....	56
3.12.1 Password.....	56
3.12.2 Backup & Restore .....	57
3.12.3 Load Factory Default.....	58
3.12.4 Display.....	59
3.13 Firmware Upgrade .....	60
3.14 Save & Reset.....	64
<b>Appendix A In-Bound Load Balance Function .....</b>	<b>65</b>
A.1 Simple Load Balance (2 WAN lines; Session 1:1) .....	66
A.2 Advanced Load Balancing.....	70

## **Chapter 1 Introduction**

Congratulations on your purchase of this outstanding IGR-1500 Four-WAN Internet Gateway, this product is specifically designed for the office that has the need to enlarge the usage bandwidth with several narrow bandwidth connections in company.

IGR-1500 features with 4 10/100 Mbps Ethernet ports (WAN port) and one 10/100 Mbps Ethernet port (LAN port). WAN port is using to connect to broadband transmission equipments such as ADSL modem or CABLE modem for user and far end to download or upload data in high speed; the LAN port works to connect to computer via cable. You can also connect LAN port with HUB/SWITCH device to extend the amount of connection device/user if necessary. Families with multiple PCs could share one ISP account and play exciting games against each other through IGR-1500. The switch function could also reduce the traffic in internal LAN.

### **1.1 Functions and Features**

- **Web configuration tool**
- **3 kinds of differential Work Mode**
- **Multiple DMZ Host (PPPoE, Static IP)**
- **Multiple Virtual Server**
- **Multiple NAT function**
- **Inbound Load Balance and Outbound Load Balance**
- **Ultra Smart Sharing**
- **Protocol Route Control (IP Binding Function, by IP & port number)**
- **Protocol Bandwidth Control (by application protocol port number)**
- **IP/URL Blocking, DoS, and Intrusion Security**
- **User Bandwidth Control Function ( by user IP address)**
- **H.323 VoIP ALG included**
- **Remote Configuration Through Internet**
- **System Log**
- **Mail Alert**
- **SPI Firewall**
- **Backup / Restore Router configuration file from PC**
- **Display real time router configuration parameter**

## 1.2 Front Panel and Rear Panel

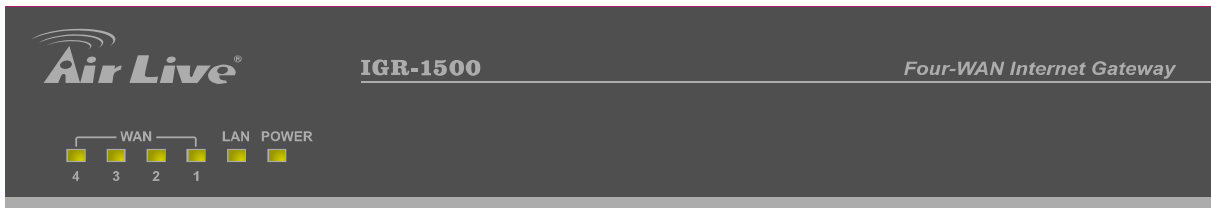

Figure 1-1 Front Panel

LED		Status	
Indicator	Color	ON	Flashing
Power	● Green	Power on	-
WAN1~4	● Green	Linked	Data Transmission
	● Red	Collision	-
LAN	● Green	Linked	Data Transmission

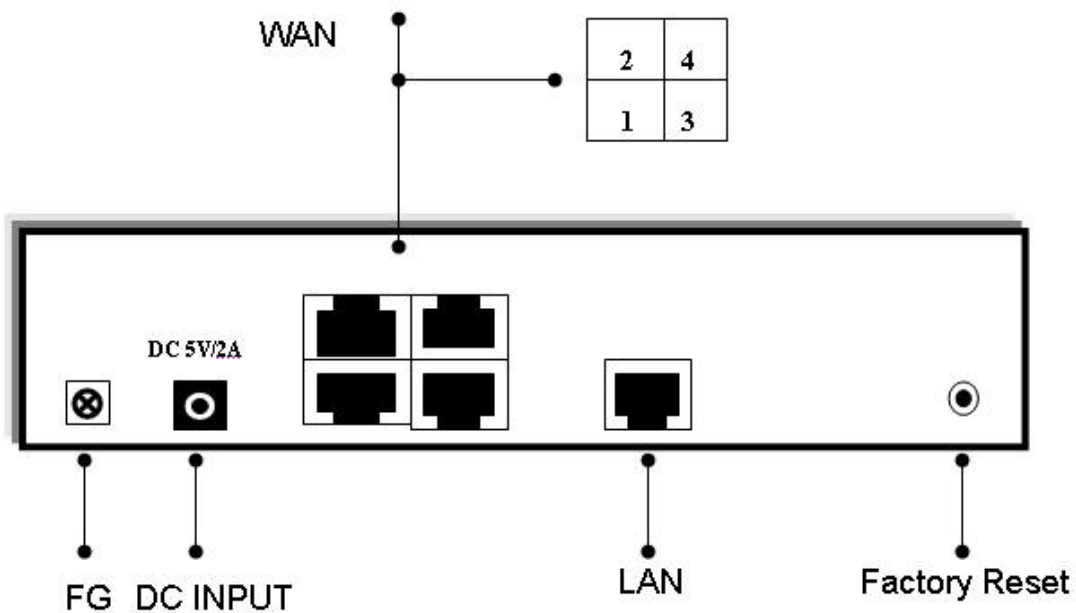

Figure 1-2 Rear Panel

### Ports:

**FG:** Ground connection

**DC 5V:** Connecting to AC adapter

**WAN1~4 Port:** Four RJ-45 type WAN ports connecting to broadband transmission equipment such as ADSL or Cable modem via RJ-45 cable.

**LAN Port:** One RJ-45 type LAN port connecting to your network devices such as Hub/Switch via RJ-45 cable.

**Factory Reset:** Press **Factory Reset** button can be defined as to reload factory default value or reset back to latest configuration by software. When you finish defining the Default Button Option, just pressing Factory Reset button 2 seconds and releasing it, the router will load the default settings or back to latest configuration.



### **1.3 Packing List**

- IGR-1500 Four-WAN Internet Gateway
- Installation CD-ROM
- Quick Installation Guide
- CAT-5 UTP Fast Ethernet cable
- AC Adapter

**When you open your package, make sure all of the above items are included and not damaged. If you see that any components are damaged, please notify your dealer immediately.**

## Chapter 2 Deployment

IGR-1500 provides one LAN port connecting to your network devices such as PC, HUB and SWITCH via RJ45 cable. Using a HUB/SWITCH will allow more PC connecting to IGR-1500. WAN ports are using to connect your ADSL or CABLE Modem to the broadband ISP.

For RJ45 cable type, both WAN/LAN port support auto MDI/MDIX Function, you can choose cross over type or straight type RJ-45 cable

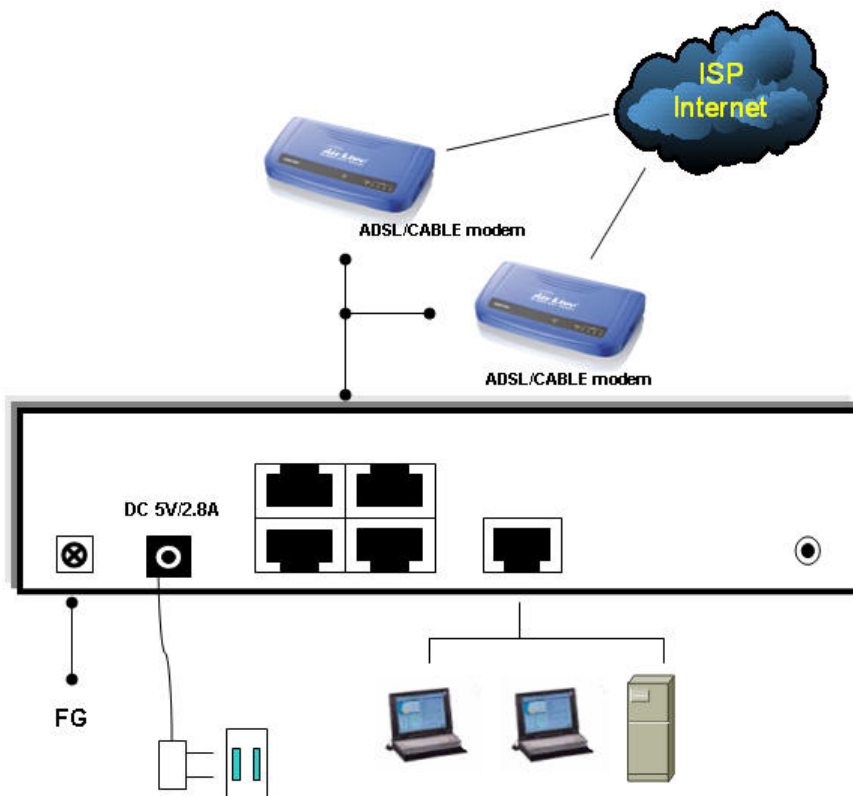

### Connection Procedure:

1. Plug in DC power adapter to Router.
2. Connect the Router WAN port RJ45 modular jack to ADSL/CABLE Modem Ethernet port with the RJ45 cable.
3. Connect the Router LAN port RJ45 modular jack to HUB/SWITCH LAN port by RJ45 cable.
4. Connect PC LAN card port to HUB/SWITCH LAN port.
5. Connect FG to ground
6. Plug in AC power cord to power source

## Chapter 3 Configure Router

### 3.1 How to start out to configure router

**Step1.** Connect the MIS engineer's PC and IGR-1500's LAN port to the same Hub / Switch, and launch the browser (IE or Netscape) to link the IGR-1500 appliance. The default IP address is http: //192.168.1.1

**Step2.** Administrator will be requested for **User Name** and **Password** when entering IGR-1500 system. (Figure 3-1)

- **User Name** : airlive
- **Password** : airlive
- Click **OK**.



Figure 3-1 Login page

**Step3.** In order to meet different application usage, you can configure this router to be 3 different working models: (Figure 3-2)

- **Gateway mode**
- **Router mode**
- **Basic NAT mode (NAT Table up to 5000 entries)**

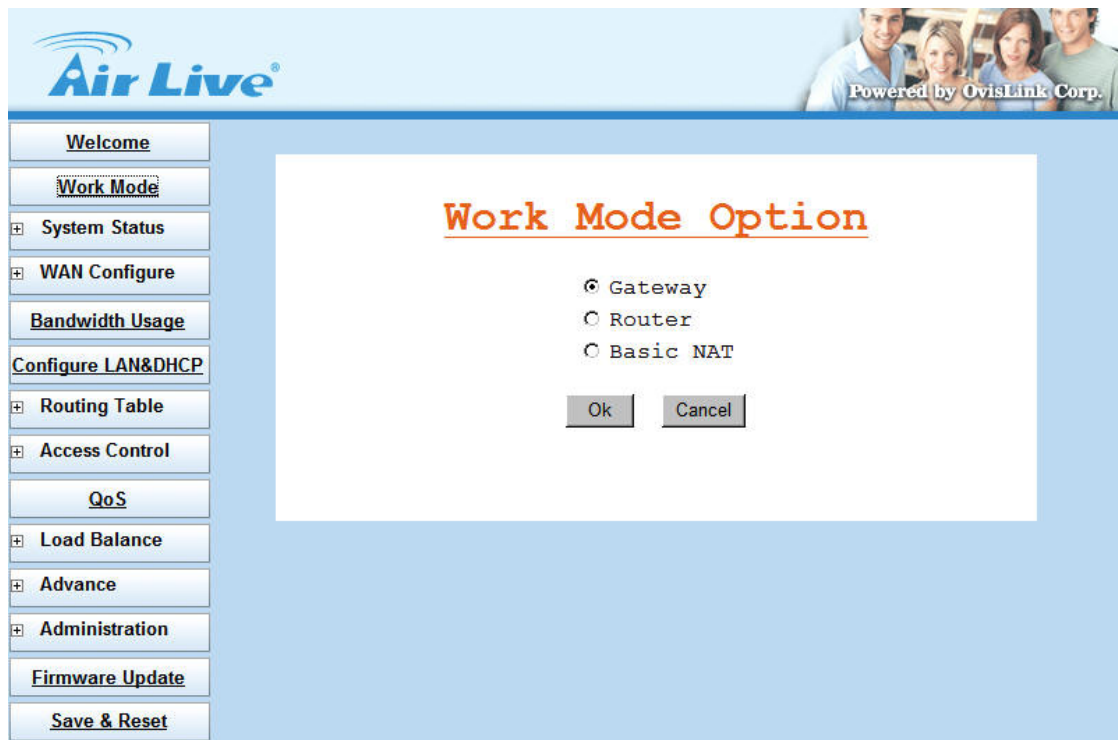

Figure 3-2 Select Work Mode

Each working mode includes different features:

Mode \ Function	LAN to WAN Throughput	NAT Function	DMZ, DoS, Virtual Server, IP Filtering	IP Domain	PPPoE Dial up
<b>Gateway Mode</b>	Good	Yes	Yes	Public To Private	Yes
<b>Router Mode</b>	Best	No	No.... (1)	Public To Public, or Private to Private (4)	No
<b>Basic NAT Mode (2)</b>	Good	Yes	Yes...(3)	Public To Private	Yes

- (1) All NAT related function will be disable
- (2) The purpose for this mode is to have high through-put and NAT function both
- (3) Simple NAT function available
- (4) Act like a multi-LAN port router



When you reset device as default setting, IGR-1500 will be reset as Gateway mode.

**Step4.** Configure each WAN port separately, and the other function you would like to use, such as Load Balance, Bandwidth Management, or else. (Figure 3-3)



The screenshot shows the 'Air Live' router configuration web interface. The left sidebar contains a navigation menu with the following items: Welcome, Work Mode, System Status, WAN Configure (expanded), WAN1 (selected), WAN2, WAN3, WAN4, Bandwidth Usage, Configure LAN&DHCP, Routing Table, Access Control, QoS, Load Balance, Advance, Administration, Firmware Update, and Save & Reset. The main content area is titled 'Configure WAN1 Port' and includes the following settings:

- Connect to:  Internet  Intranet
- Healthy Check:  Enable  Disable
- WAN Type**
  - Dynamic IP
  - PPPoE
  - Static IP
- Schedule**
  - Schedule:  Enable  Disable
- WAN Link Mode**
  - Auto Sense (dropdown menu)
- Buttons: Ok, Cancel

Figure 3-3 Configure WAN port setting



You can refer to the manual for more understanding of else router's feature.

### 3.2 Work Mode

In order to meet different application usage, you can configure this router into 3 different working modes.

- Gateway mode
- Router mode
- Basic NAT mode

Each working mode includes different features:

Function Mode	LAN to WAN Throughput	NAT Function	DMZ, DoS, Virtual Server, IP Filtering	IP Domain	PPPoE Dial up
<b>Gateway Mode</b>	Good	Yes	Yes	Public To Private	Yes
<b>Router Mode</b>	Best	No	No.... (1)	Public To Public, or Private to Private (4)	No
<b>Basic NAT Mode (2)</b>	Good	Yes	Yes...(3)	Public To Private	Yes

(1) All NAT related function will be disable

(2) The purpose for this mode is to have high through-put and NAT function both

(3) Simple NAT function available

(4) Act like a multi-LAN port router

#### **Work Mode / Function List**

Function Mode	Gateway	Router	Basic NAT
PPPoE / Dial Up DSL Type	V		V
Local IP Filtering	V		
Remote IP Filtering	V		
Intrusion Security	V		
Dos Defense	V		
URL Filtering	V		
Remote Configure	V	V	V
Virtual Server	V		V
DMZ Host	V		V
Multi-NAT	V		V
IP Binding	V		V
Load Balance	V		V
Dynamic DNS	V		V
Mail Alert	V		V

Time Zone	V	V	V
System Log	V	V	V
Mac Address Clone	V	V	V
Configure Proxy	V		V
Routing protocol	V	V	V
DOD (PPPoE)	V		V
Bandwidth Usage Control	V		V
QoS	V		V

## 3.3 System Status

### 3.3.1 Link Status

You can get the following information in Link Status window: (Figure 3-4)

- LAN Status
- WAN Status
- Firmware Version
- DHCP Table

The screenshot shows the Air Live web interface. On the left is a navigation menu with options like Welcome, Work Mode, System Status, Link Status, Data Monitor, WAN Configure, Bandwidth Usage, Configure LAN&DHCP, Routing Table, Access Control, QoS, Load Balance, Advance, Administration, Firmware Update, and Save & Reset. The main content area is titled 'LINK STATUS' and contains four sections: LAN Status, WAN Status, Firmware, and DHCP Table.

**LAN Status**

IP Address	192.168.1.1
MAC Address	00:D0:DA:00:45:28
Subnet Mask	255.255.255.0
DHCP	Enable

**WAN Status**

WAN1

MAC Address	00:D0:DA:00:45:29
IP Address	192.168.0.45
Subnet Mask	255.255.255.0
WAN Status	Connected

WAN1 Disconnect

**Firmware**

Firmware Version	IGR1500 V1027-MB2.4-E
Release Day	Aug 8 2007

**DHCP Table**

MAC Address	IP Address
00:d0:59:59:79:2d	192.168.1.12

Figure 3-4 Link Status

**LAN Status:** Shows the information of **MAC Address**, **IP Address**, **Subnet Mask** and **DHCP Status** (Enable/Disable).

**WAN Status:** Shows the information of **MAC Address**, **IP Address**, **Subnet Mask** and **WAN Status** on each or all **WAN** ports

**Firmware version:** version of software and its released date.

**DHCP Table:** Shows the information of **MAC Address** and **IP Address**.



### 3.3.2 Data Monitor

Differ with Link Status window, Data Monitor window provides detail packet transfer status. It includes 2 kinds of real time data per each WAN port. (Figure 3-5)

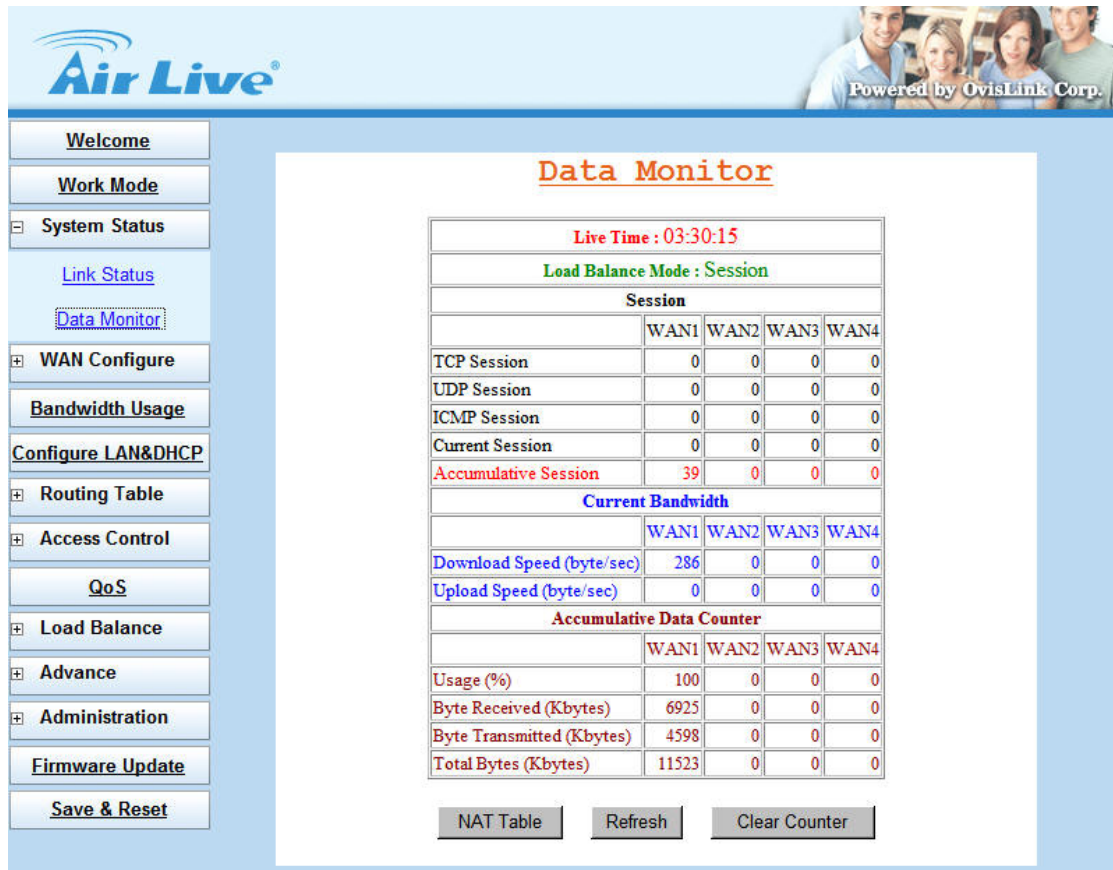

Figure 3-5 Data Monitor

- **Current Session:**

- ◆ TCP Session:
- ◆ UDP Session:
- ◆ ICMP Session:
- ◆ Total Session:

- **Current Bandwidth:**

- ◆ Download Speed:
- ◆ Upload Speed

- **Accumulative Data Counter:**

- ◆ Usage (%): For example, WAN1 usage% =  $\frac{\text{WAN1 total packets}}{(\text{WAN1}+\text{WAN2}) \text{ total packets}} \%$
- ◆ Byte Received
- ◆ Byte Transmitted
- ◆ Total Bytes: Total packets transfer by each WAN port

- **NAT Table:** list current user detail NAT data. (Figure 3-6)
- **Refresh:** update data monitor table to display newest data
- **Clear Counter:** reset **Data Counter** data to 0, and restart to accumulate the packets.

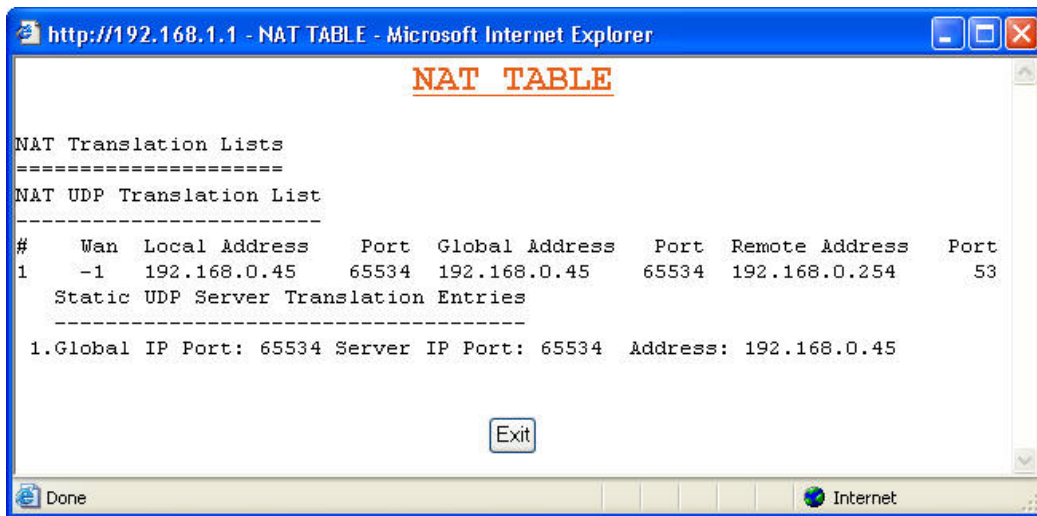

Figure 3-6 NAT Table



The packets start to accumulate from:

1. Router powers on
2. Clear counter
3. Counter reaches upper the limitation (4294967K), and then the counter will reset to 0 automatically.

### 3.4 WAN Configure

There are several **WAN** function can be made in this display, you can configure functions to each WAN port separately.

- **Connect to:**
  - ◆ **Internet:** WAN port is connected to Internet through ADSL/Cable modem
  - ◆ **Intranet:** WAN port is connected to another router LAN port, work together with “Static Route” function, can restrict specific IP packet to a dedicate route path.
- **Healthy Check:**
  - ◆ **Enable:** Enable the feature to check whether the WAN link is alive or not. System provides 3 methods to check the WAN link, **Ping IP**, **DNS**, and **Time Server**; you can choose it with each method or both. It is suggested to select at least 2 methods to check the WAN link, in order to avoid router making wrong action due to Internet Server disable. (Figure 3-7)
  - ◆ **Disable:** If “Time Server” does not exist, this function will disable automatically.

### Configure WAN1 Port

Connect to  Internet  Intranet

Healthy Check :  Enable  Disable

<input checked="" type="checkbox"/> Ping IP :	<input type="text" value="60.250.158.64"/>	<input type="button" value="Test"/>
<input checked="" type="checkbox"/> DNS :	<input type="text" value="168.95.1.1"/>	<input type="button" value="Test"/>
<input checked="" type="checkbox"/> Time Server		<input type="button" value="Test"/>

**Figure 3-7 Healthy Check**

- **Dynamic IP:** Connect to Cable Modem and obtain an IP address from ISP automatically.
- **PPPoE:** Connect to Dial Up DSL (Gateway / Basic NAT Mode only)
- **Static IP:** Connect to Leased DSL
- **Schedule:** This function allows you to control each WAN port link up/down time by daily/weekly.
  - ◆ **Start Time: (hh:mm)**
  - ◆ **End Time: (hh:mm)**
  - ◆ **Weekly:** choose by day



When you enable Schedule function, the WAN connection will follow the Schedule to link up or down, no matter DOD (Dial-on-demand) function is enabled or disabled.

- **WAN Link Mode:** You can choose the WAN interface type in order to follow the connecting type of ISP.
  - ◆ **Auto Sense**
  - ◆ **10Mbps Half Duplex**
  - ◆ **10Mbps Full Duplex**
  - ◆ **100Mbps Half Duplex**
  - ◆ **100Mbps Full Duplex**

### 3.4.1 WAN Type – Dynamic IP

Usually it's used to connect CABLE modem. You won't need to assign IP address, and the IGR-1500 will get the IP address for ISP automatically. (Figure 3-8)



Figure 3-8 Dynamic IP

- **Gateway / Basic Mode:** When you choose Dynamic IP, you only need to save this selection, and reboot router when you finish configuring all parameter.
- **Router Mode:** For **Intranet** use only, IGR-1500 can obtain IP from DHCP Server automatically.

### 3.4.2 WAN Type – PPPoE

Connect to ISP via dial-up connecting, ISP will assign a legal IP to you after the user Id and password had been passed. (The user Id and password here are provided by your ISP.) (Figure 3-9)

The screenshot shows the 'Air Live' web interface. The main content area is titled 'Configure WAN1 Port'. At the top, it says 'Connect to  Internet  Intranet'. Below that, 'Healthy Check :  Enable  Disable'. The 'WAN Type' section has radio buttons for 'Dynamic IP' and 'PPPoE', with 'PPPoE' selected. The 'PPPoE' section includes input fields for 'Account' (containing '16182168@hinet.net'), 'Password' (masked with dots), 'Service Name', and 'Max Idle Time(min)' (set to 0). There are radio buttons for 'Dial On Demand' with options 'Manual' (selected), 'Dial-on-demand', and 'Always-on'. Below this is the 'Static IP' section. The 'Schedule' section has radio buttons for 'Enable' and 'Disable', with 'Disable' selected. The 'WAN Link Mode' section has a dropdown menu set to 'Auto Sense'. At the bottom are 'Ok' and 'Cancel' buttons. A left sidebar contains navigation links like 'Welcome', 'Work Mode', 'System Status', 'WAN Configure', 'WAN1', 'WAN2', 'WAN3', 'WAN4', 'Bandwidth Usage', 'Configure LAN&DHCP', 'Routing Table', 'Access Control', 'QoS', 'Load Balance', 'Advance', 'Administration', 'Firmware Update', and 'Save & Reset'.

Figure 3-9 PPPoE

- **Account:** The user name provided by ISP, the character can be entered up to 60.
- **Password:** The password provided by ISP, the character can be entered up to 60.
- **Service Name:** This is optional. The Service name is needed if ISP requires for it.
- **Max. Idle Time (min):** The default value is 0, means not to check the idle time, so the connection will remain connecting unless user disconnects it by manually.
- **Dial On Demand:** Auto connect function
  - ◆ **Manual:** You need to initiate WAN connection manually, by clicking **WAN1 connect** or **WAN2 connect** button in **System Status** → **Link Status** menu. However, power up or reset also can initiate the WAN connection.
  - ◆ **Dial-on-demand:** Whenever a user is trying to access the Internet from his computer, this WAN port will start connection automatically if it is disconnected.
  - ◆ **Always-on:** The WAN port will try to establish the connection as long as it is disconnected, no matter this port is used or not.



About "Always-on" function, normally you need to combine "Healthy Check" function together, then "Always-on" can work more perfectly because there is an ADSL modem between router & ISP equipment. In physical layer, if ADSL line fails but ADSL modem is still alive, and router can not detect the line status unless ISP sends a disconnected packet to router. So if ADSL line is in abnormal up-down, sometimes router can not get disconnect packet from ISP. Maybe in ISP side, it treats line as disconnected status, but router seems like to be still in "connecting" status.

If you enable "Healthy Check" in each line, then router can automatically send packet out through WAN to detect whether line is active or not. (1 packet per 30 sec) This function will be helpful to judge the line status, and provide correct information to router for the Link Status.



It's better to enable at least 2 options in "Healthy Check", in order to avoid misjudgments when only 1 option is selected and the option server fails to respond the request.

### 3.4.3 WAN Type – Static IP

When user applied the leased line from ISP, the service provider will offer user the real IP, Subnet Mask, Gateway and DNS. You need to indicate the static IP manually. (Figure 3-10)

The screenshot shows the 'Air Live' router configuration interface. The main content area is titled 'Configure WAN1 Port'. At the top, it says 'Connect to  Internet  Intranet'. Below that, 'Healthy Check :  Enable  Disable'. The 'WAN Type' section has three radio buttons: 'Dynamic IP', 'PPPoE', and 'Static IP', with 'Static IP' selected. The 'Static IP' section contains the following fields:

IP Address :	192	.	168	.	11	.	100
Subnet Mask :	255	.	255	.	255	.	0
Primary DNS :	168	.	95	.	1	.	1
Secondary DNS :	168	.	95	.	192	.	1
Gateway :	192	.	168	.	11	.	254

The 'Schedule' section has 'Schedule :  Enable  Disable'. The 'WAN Link Mode' section has a dropdown menu set to 'Auto Sense'. At the bottom are 'Ok' and 'Cancel' buttons.

Figure 3-10 Static IP

### 3.5 Bandwidth Usage

This is a very useful function, it can let you to control WAN port bandwidth usage by each protocol. Like FTP, when someone uses FTP to transfer file, it will occupy heavy loading by using this function, so you can limit the dedicated application bandwidth as you want to.

**For example:**

In following display, FTP, HTTP & Mail bandwidth will be limited in certain percentage. This router provides 3 most often use protocol in the table, and you just need to fill in port number and % usage for each application:

- **Select WAN Port:** Select the WAN interface for the bandwidth definition
- **WAN Speed:** Enter the upload and download speed provided by ISP
  - ◆ **Upload** (kbits/s)
  - ◆ **Download** (kbits/s)
- **Usage Set:**
  - ◆ **Protocol:** name of protocol data packet will be limited.
  - ◆ **Port:** protocol port number
  - ◆ **Usage %:** The usage percentage of WAN speed(Figure 3-11)

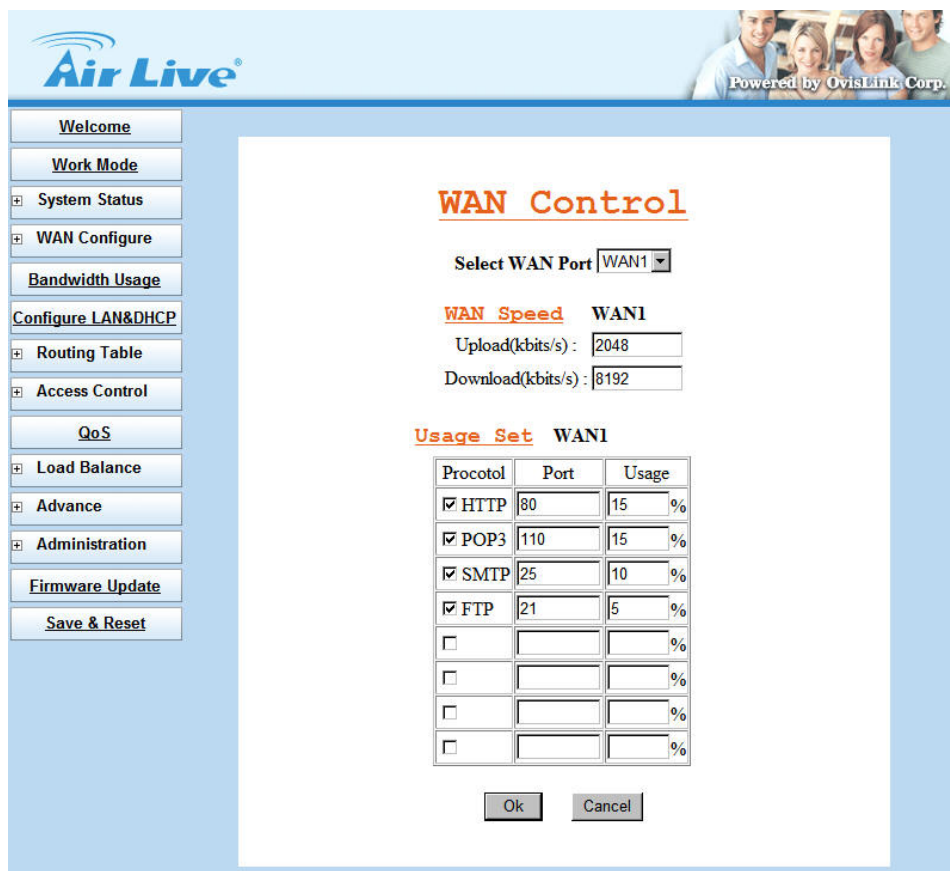

Figure 3-11 Bandwidth Usage



The totally amount of protocol usage percentage can not exceed 100% for each WAN port.



Router provides another 4 self-defined port number, user just needs to fill in port number for each protocol.



### 3.6 Configure LAN & DHCP

This function configures the LAN ports **IP address**, **Subnet Mask**, and **DHCP server**.

You can choose using DHCP server or disable it, the Dynamic Host Configuration Protocol (DHCP) allows the Broadband Router to dynamically assign IP addresses to network devices. Dynamic IP assignment alleviates the need for the network administrator to maintain and monitor IP address assignments and simplifies IP use because the IP addresses are automatically and dynamically assigned when a station powers-on. You will need to indicate the range of DHCP server and DNS address if you enable DHCP server function.

(Figure 3-12)

You can also reserve some IP's to specific computers. You need to enter the name (MAC address) of the network card installed in your computer to assign a particular IP to it. Enter the relative values and then click **Add**. (Figure 3-13)

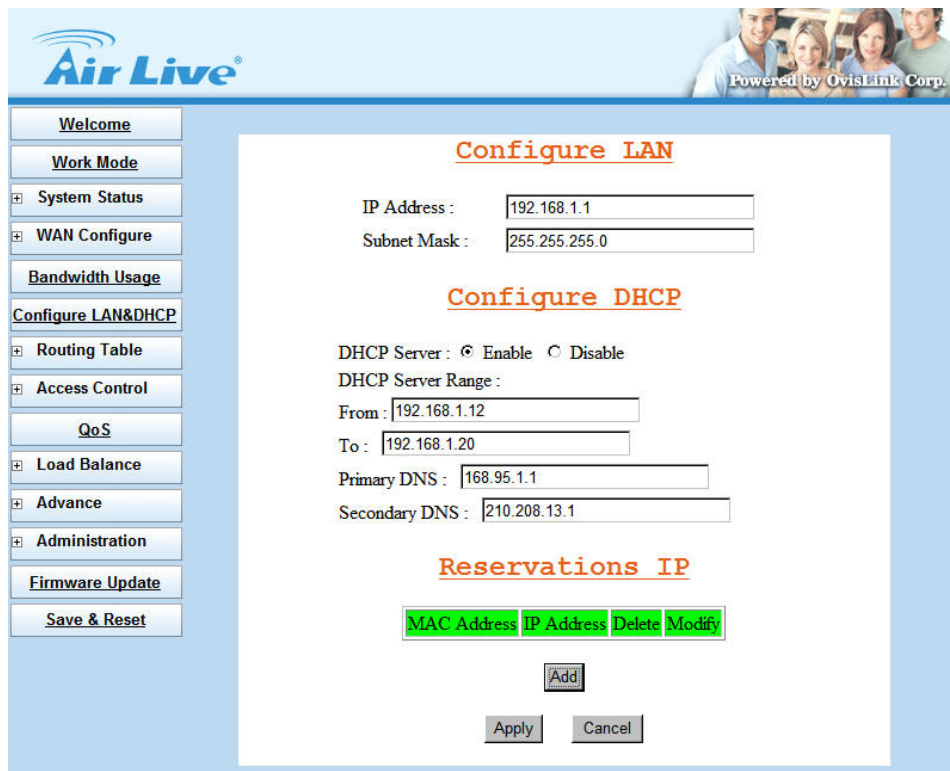

Figure 3-12 Configure LAN & DHCP

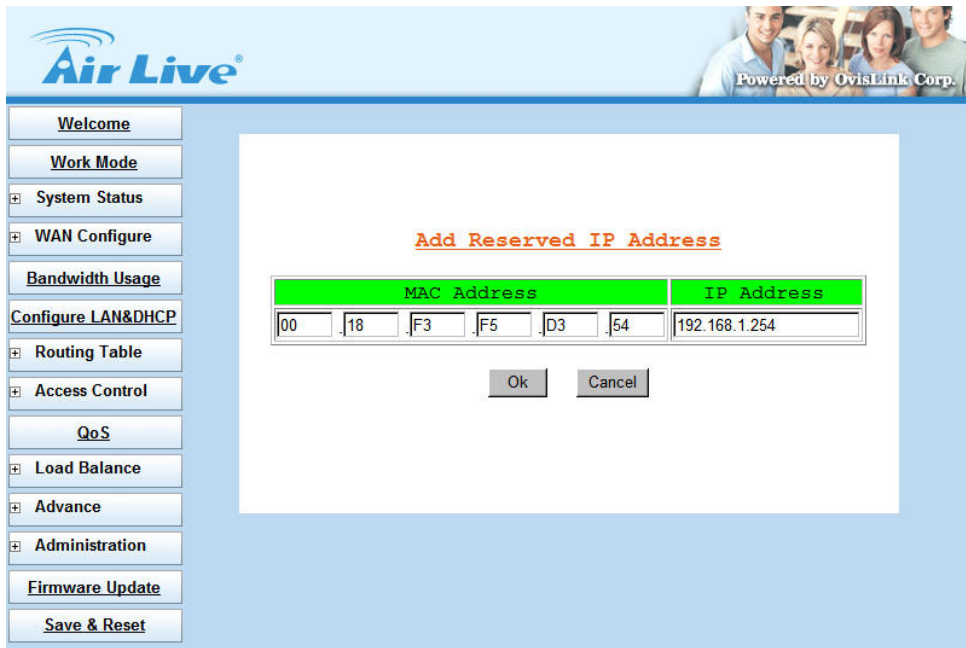

Figure 3-13 Add Reserved IP Address



When enable DHCP Server in “From”, ”TO” field, you can reserve up to **253** IP address to DHCP server.



Fill in local DNS Server IP address in “**DNS Address**” field, the DNS IP information will also assign to DHCP client.

## 3.7 Routing Table

### 3.7.1 Configure

This function allows manually defined by users as the only path to the destination. Users can configure the static routing path to IGR-1500.

#### ■ **Static Routing - Gateway Mode:**

There have one pc with two interfaces in this area, one interface is connected to IGR-1500 (domain A), and the other connected to another Server (domain B). Users need to set the static routing path in IGR-1500 in order to recognize another domain in this area. These settings enable the packets from domain A to the destination in domain B via the gateway configured in IGR-1500. (Figure 3-14, 3-15)

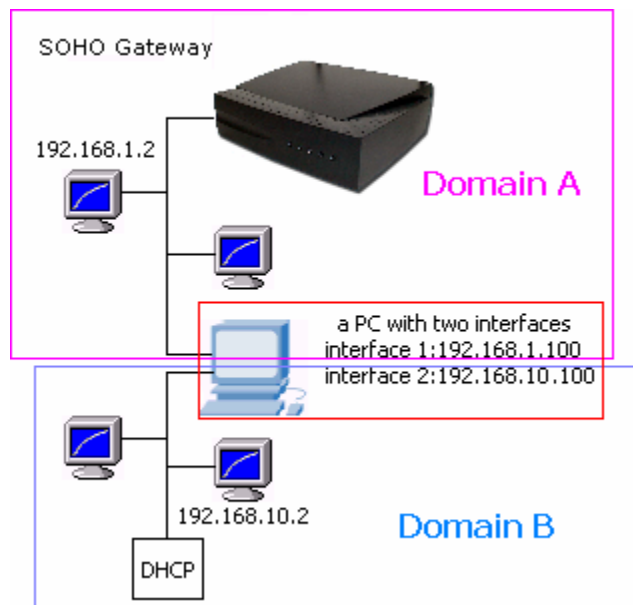

Figure 3-14 Static Routing – Gateway Mode

#### ■ **Static Routing - Route Mode:**

It will disable all the functions related to NAT, such as Virtual Server, DMZ, Multi-DMZ, IP Filter, DoS and so on.

Router mode supports neither PPPoE nor Dial-up connection. It's only been used for the route between two domains. In other words, router mode supports the transmission of data between two different domains via WAN port. The IGR-1500 needs to use static routing or dynamic routing (RIP1/RIP2) to obtain routing table from each other. Thus, the PCs in domain A and PCs in domain B can access the data with each other via the router mode.

## ■ Static Routing – Basic NAT Mode

Similar to Gateway mode, the difference is that Basic NAT mode only has Basic NAT function. Once you select Basic NAT mode, all the additional function such as DoD (Dial on Demand), IP Filter, DoS and so on will be disabled. You may select Basic NAT mode to obtain higher speed otherwise you have to select Gateway mode to enable these functions.

## ■ Dynamic Routing

Dynamic Routing allows router learning the path to destination by receiving periodic updates from others. The protocol used in communication between routers is RIP v1 and v2. (Routing Information Protocol). RIP1 supports only to broadcast mode while RIP2 supports broadcast and multicast mode. (Figure 3-15)

The screenshot displays the 'Air Live' router configuration web interface. On the left is a navigation menu with options like 'Welcome', 'Work Mode', 'System Status', 'WAN Configure', 'Bandwidth Usage', 'Configure LAN&DHCP', 'Routing Table', 'Access Control', 'QoS', 'Load Balance', 'Advance', 'Administration', 'Firmware Update', and 'Save & Reset'. The main content area is titled 'Static Routing' and contains a table with 5 rows. The first row is populated with network information, and the 'Enable' column has a checked checkbox. Below this is the 'Dynamic Routing' section, which includes an 'Enable' checkbox (checked), a 'Version' dropdown set to 'RIP 2', a 'Multicast/Broadcast' dropdown set to 'Broadcast', and three input fields for 'Periodic announcement interval (seconds): 30', 'Time before routes expire (seconds): 180', and 'Time before route is removed (seconds): 120'. 'Ok' and 'Cancel' buttons are at the bottom.

Item	Network	Netmask	Gateway	Enable
1	192.168.1.0	255.255.255.0	192.168.1.100	<input checked="" type="checkbox"/>
2				<input type="checkbox"/>
3				<input type="checkbox"/>
4				<input type="checkbox"/>
5				<input type="checkbox"/>

**Dynamic Routing**

Enable:

Version:

Multicast/Broadcast:

Periodic announcement interval (seconds):

Time before routes expire (seconds):

Time before route is removed (seconds):

Figure 3-15 Static Routing and Dynamic Routing

### 3.7.2 Current Table

This display shows the valid routing paths in IGR-1500. Users can view the information about current routing paths. (Figure 3-16)

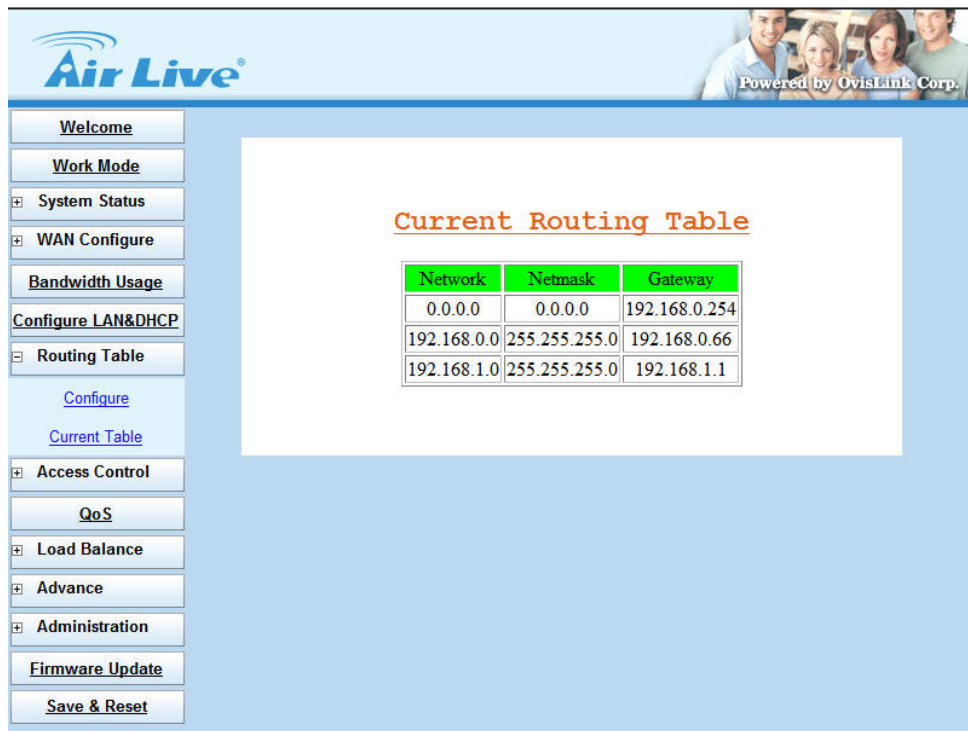

The screenshot displays the Air Live web interface. The top header features the 'Air Live' logo and a photo of a family with the text 'Powered by OvisLink Corp.'. A left-hand navigation menu contains various system configuration options. The main content area is titled 'Current Routing Table' and contains a table with three columns: Network, Netmask, and Gateway. The table lists three routing entries.

Network	Netmask	Gateway
0.0.0.0	0.0.0.0	192.168.0.254
192.168.0.0	255.255.255.0	192.168.0.66
192.168.1.0	255.255.255.0	192.168.1.1

Figure 3-16 Current Table

## **3.8 Access Control**

### **3.8.1 Local IP Filtering (Gateway Mode only)**

AirLive IGR-1500 allows you to define the accessed restriction about to block or allow outgoing IP packets per protocol (port number).

You may restrict specific IP to perform limited protocols or allow them to execute partial protocols. And the first thing you have to know is the port numbers and their usages.

Local IP Filtering can be defined 10 items and item 1 has the highest priority. In principle, the same IP should not list in different items. If IP settings are conflicted, the higher priority item will be the obeyed rules.

You can reserve dedicate IP address to dedicated user from **Configure LAN & DHCP → Reservations IP** function, by using this function, user can have dedicated IP address match to their computer NIC MAC address.

There are ten items in this function. You can allow or restrict specific IP(s) to access some port numbers.

#### **Example 1:**

If you restrict the PC of IP 192.168.1.13-192.168.1.15 to access HTTP, the settings are:

Item 1: Enable

Filter entry: Block

Port Number: 80

IP address: 192.168.1.13-192.168.1.15

#### **Example 2:**

If you allow the PC of IP 192.168.1.16-192.168.1.18 to access FTP only, the settings are:

Item 2: Enable

Filter entry: Allow

Port Number: 21

IP address: 192.168.1.16-192.168.1.18

#### **Example 3:**

If you allow the PC of IP 192.168.1.40, 192.168.1.56, 192.168.1.100-192.168.1.120 to access port 50, port53, port100-120 only, the settings are:

Item 3: Enable

Filter entry: Allow

Port Number: 50, 53, 100-120

IP address: 192.168.1.40, 192.168.1.56, 192.168.1.100-120 (Figure 3-17)



Figure 3-17 Local IP Filtering Example Setting

■ Protocol Port Number List

Protocol	Service	Port no.	Protocol	Service	Port no.
TCP	FTP	21	TCP	LADP	389
TCP	SSH	22	TCP	HTTPS	443
TCP	TELNET	23	UDP	IKE	500
TCP	SMTP	25	TCP	RLOGIN	513
UDP	DNS	53	UDP	SYSLOG	514
UDP	TFTP	69	UDP	TALK	517,518
TCP	GOTHER	70	UDP	RIP	520
TCP	FINGER	79	TCP	AFPOWERTCP	548
TCP	HTTP	80	TCP	Net-Meeting	1503,1702
TCP	POP3	110	TCP	L2TP	1701
UDP	NFS	111	TCP	PPTP	1723
TCP	NNTP	119	TCP	AOL	5190~5194
UDP	NTP	123	UDP	PC Anywhere	5631~5632
TCP	IMAP	143	TCP	XWINDOW	6000-6063
UDP	SNMP	161	TCP	IRC	6660~6669
TCP	BGP	179	TCP	Real-Media	7070
TCP	WAIS	210	TCP		6000-6063

### 3.8.2 Remote IP Filtering (Gateway Mode only)

AirLive IGR-1500 features to define accessed restriction for remote users. You may restrict some destination IP addresses that are not allowed to reach IGR-1500.

- **IP Address:** destination IP address that prohibits users to reach
- **Enable:** enable restrict function

(Figure 3-18)



Figure 3-18 Remote IP Filtering Example Setting



### 3.8.3 Intrusion Security (Gateway Mode only)

AirLive IGR-1500 features Intrusion Security, to allow user setting as “BLOCK” or “PASS” function following by the table content. The restricted user can be defined with its IP and MAC address.

(Figure 3-19)



Figure 3-19 Intrusion Security

### 3.8.4 DoS Defense (Gateway Mode only)

AirLive IGR-1500 also provides DoS (Denial of Service Defense) function to protect your network servers, hosts, routers and other devices from the attacking of villain using mass data transmission. (Figure 3-20)

The default value in the display is the optimize parameter for Router. (Figure 3-21)

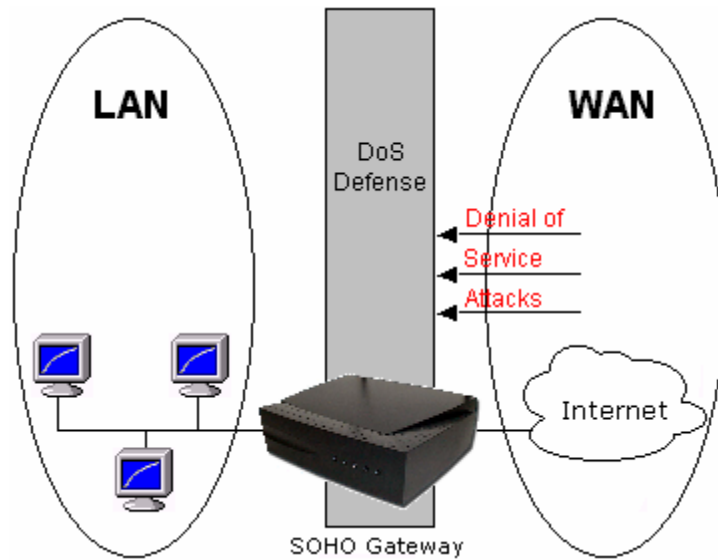

Figure 3-20 DoS Defense

**Air Live**  
Powered by OvisLink Corp.

**DoS Defense**

Function	Parameter	Lock Time	Enable
IP Fragments Checking			<input type="checkbox"/>
IP Address spoofing			<input type="checkbox"/>
Disable Ping(ICMP) respond	<input type="checkbox"/> LAN <input type="checkbox"/> WAN1 <input type="checkbox"/> WAN2 <input type="checkbox"/> WAN3 <input type="checkbox"/> WAN4		<input type="checkbox"/>
Oversized Ping	32 bytes		<input checked="" type="checkbox"/>
Drop IP Packet with Source Route Option			<input type="checkbox"/>
Port Scan	1000 ports/sec	5 min	<input checked="" type="checkbox"/>
TCP SYN Flooding (WAN)	1000 times/sec	5 min	<input checked="" type="checkbox"/>
TCP SYN Flooding (LAN)	1000 times/sec	5 min	<input checked="" type="checkbox"/>
ICMP Flooding (WAN)	1000 times/sec	5 min	<input checked="" type="checkbox"/>
ICMP Flooding (LAN)	1000 times/sec	5 min	<input checked="" type="checkbox"/>
UDP Flooding (WAN)	1000 times/sec	5 min	<input checked="" type="checkbox"/>
UDP Flooding (LAN)	1000 times/sec	5 min	<input checked="" type="checkbox"/>

Ok Cancel

Figure 3-21 Default Setting of DoS Defense

Some virus are using “PING” command to attack network, AirLive IGR-1500 can be defined as accept or reject “PING” command from WAN or LAN. (Figure 3-22)

Disable Ping(ICMP) respond	<input checked="" type="checkbox"/> LAN		<input checked="" type="checkbox"/>
	<input checked="" type="checkbox"/> WAN1 <input checked="" type="checkbox"/> WAN2		
	<input checked="" type="checkbox"/> WAN3 <input checked="" type="checkbox"/> WAN4		

Figure 3-22 Disable Ping respond

Function	Description
<b>IP Fragments Checking</b>	Checking the IP fragments. When it finds someone from WAN side tries to attack your network using overlap IP fragments in a bad attention, this function will check over these packets and drop them.
<b>IP Address spoofing</b>	Finding out whether the source address(s) and destination address(s) are legal IP's or not. If they are illegal IP's or multicast addresses, this function will cast these packets away.
<b>Oversized Ping</b>	Dropping the packets of “ping” which exceed the size you set. The default value is 32 bytes.
<b>Drop IP Packet with Source Route Option</b>	Casing a packet away when it contains source route option(s) in its IP.
<b>Port Scan</b>	When an IP from Internet tries to scan the IP of IGR-1500 up to 10000ports/sec (default value), this function will drop all the packets from this IP within 5 minutes (default value).
<b>TCP SYN Flooding (WAN)</b>	When a destination address and destination port of IGR-1500 receives TCP SYN packet from WAN over 10000 times (default value) in one second, IGR-1500 will close this address and port for 5 minutes (default value) temporarily.
<b>TCP SYN Flooding (LAN)</b>	When an IP in LAN of IGR-1500 tries to send TCP SYN packet over 10000 times (default value) in one second, IGR-1500 will close this source address for 5 minutes (default value) temporarily.
<b>ICMP Flooding (WAN)</b>	When a destination address of IGR-1500 receives ICMP from WAN over 10000 times (default value) in one second, IGR-1500 will close this address for 5 minutes (default value) temporarily.
<b>ICMP Flooding (LAN)</b>	When an IP in LAN of IGR-1500 tries to send ICMP over 10000 times (default value) in one second, IGR-1500 will close this source address for 5 minutes (default value) temporarily.
<b>UDP Flooding (WAN)</b>	When a destination address of IGR-1500 receives UDP from WAN over 10000 times (default value) in one second, IGR-1500 will close this address for 5 minutes (default value) temporarily.
<b>UDP Flooding (LAN)</b>	When an IP in LAN of IGR-1500 tries to send UDP over 10000 times (default value) in one second, IGR-1500 will close this source address for 5 minutes (default value) temporarily.

### 3.8.5 URL Filtering (Gateway Mode only)

Besides restrict users by local/destination IP, AirLive IGR-1500 provides you to do accessed restriction for user by URL as well.

You may restrict some URL address that are not allowed to reach

- **Enable URL Filter On Http Port:** You can define the port number for URL Filtering, and select to enable the rule.
- **PASS or BLOCK for all URL:** Select a basic rule as the foundation, and then to define the **Exclusive List**.
- **Exclusive List:** Define specific keyword as the Exclusive List.
  - ◆ **Keyword:** destination URL that prohibit users to reach
- **Supervisor IP List:** Specify IP address that will not be filtered with URL filtering rule.

(Figure 3-23)

The screenshot shows the AirLive web interface for URL Filtering configuration. The main content area includes the following elements:

- URL Filtering** (Section Header)
- Enable URL Filter On Http Port
- PASS  BLOCK for all URL
- Exclusive List**
- | Item | Keyword  |
|------|----------|
| 1    | violence |
| 2    | sex      |
| 3    |          |
| 4    |          |
| 5    |          |
| 6    |          |
| 7    |          |
| 8    |          |
| 9    |          |
| 10   |          |
- Supervisor IP List**
- | Item | IP | Enable                   |
|------|----|--------------------------|
| 1    |    | <input type="checkbox"/> |
| 2    |    | <input type="checkbox"/> |
| 3    |    | <input type="checkbox"/> |
| 4    |    | <input type="checkbox"/> |
| 5    |    | <input type="checkbox"/> |
- Buttons:

Figure 3-23 Disable Ping response

### 3.9 QoS

With QoS function, you can set up **user bandwidth** with Maximum & Minimum bandwidth value.

- **Configure WAN Speed:** The WAN speeds must be configured for the QoS configuration to take effect.
- **IP MAX/MIN Limit:** Allocate bandwidth to users:
  - ◆ **IP:** IP address of specified user
  - ◆ **MAX:** Bandwidth limitation to this user
  - ◆ **MIN:** Minimal Bandwidth keeps for this user before allocating any bandwidth from this user to others
  - ◆ **Down Rate:** Download speed
  - ◆ **Up Rate:** Upload speed
  - ◆ **WAN Apply:** Which WAN you want the allocation to take effect. (Do not use this option to specify which WAN to use for this user.) (Figure 3-24)

**Configure WAN Speed**

	Download(kbps)	UpLoad(kbps)
WAN 1	8192	2048
WAN 2	1024	512
WAN 3	2048	1024
WAN 4		

**IP MAX/MIN Limit**

IP	MAX/MIN	Down Rate	Up Rate	WAN Apply	En
192.168.1.15	MAX	128 kbits	64 kbits	<input checked="" type="checkbox"/> 1 <input type="checkbox"/> 2 <input type="checkbox"/> 3 <input type="checkbox"/> 4	<input checked="" type="checkbox"/>
192.168.1.101	MAX	128 kbits	64 kbits	<input type="checkbox"/> 1 <input checked="" type="checkbox"/> 2 <input checked="" type="checkbox"/> 3 <input type="checkbox"/> 4	<input checked="" type="checkbox"/>
	MIN	0 kbits	0 kbits	<input type="checkbox"/> 1 <input type="checkbox"/> 2 <input type="checkbox"/> 3 <input type="checkbox"/> 4	<input type="checkbox"/>
	MIN	0 kbits	0 kbits	<input type="checkbox"/> 1 <input type="checkbox"/> 2 <input type="checkbox"/> 3 <input type="checkbox"/> 4	<input type="checkbox"/>
	MIN	0 kbits	0 kbits	<input type="checkbox"/> 1 <input type="checkbox"/> 2 <input type="checkbox"/> 3 <input type="checkbox"/> 4	<input type="checkbox"/>
	MIN	0 kbits	0 kbits	<input type="checkbox"/> 1 <input type="checkbox"/> 2 <input type="checkbox"/> 3 <input type="checkbox"/> 4	<input type="checkbox"/>
	MIN	0 kbits	0 kbits	<input type="checkbox"/> 1 <input type="checkbox"/> 2 <input type="checkbox"/> 3 <input type="checkbox"/> 4	<input type="checkbox"/>
	MIN	0 kbits	0 kbits	<input type="checkbox"/> 1 <input type="checkbox"/> 2 <input type="checkbox"/> 3 <input type="checkbox"/> 4	<input type="checkbox"/>
	MIN	0 kbits	0 kbits	<input type="checkbox"/> 1 <input type="checkbox"/> 2 <input type="checkbox"/> 3 <input type="checkbox"/> 4	<input type="checkbox"/>
	MIN	0 kbits	0 kbits	<input type="checkbox"/> 1 <input type="checkbox"/> 2 <input type="checkbox"/> 3 <input type="checkbox"/> 4	<input type="checkbox"/>
	MIN	0 kbits	0 kbits	<input type="checkbox"/> 1 <input type="checkbox"/> 2 <input type="checkbox"/> 3 <input type="checkbox"/> 4	<input type="checkbox"/>
	MIN	0 kbits	0 kbits	<input type="checkbox"/> 1 <input type="checkbox"/> 2 <input type="checkbox"/> 3 <input type="checkbox"/> 4	<input type="checkbox"/>
	MIN	0 kbits	0 kbits	<input type="checkbox"/> 1 <input type="checkbox"/> 2 <input type="checkbox"/> 3 <input type="checkbox"/> 4	<input type="checkbox"/>
	MIN	0 kbits	0 kbits	<input type="checkbox"/> 1 <input type="checkbox"/> 2 <input type="checkbox"/> 3 <input type="checkbox"/> 4	<input type="checkbox"/>
	MIN	0 kbits	0 kbits	<input type="checkbox"/> 1 <input type="checkbox"/> 2 <input type="checkbox"/> 3 <input type="checkbox"/> 4	<input type="checkbox"/>
	MIN	0 kbits	0 kbits	<input type="checkbox"/> 1 <input type="checkbox"/> 2 <input type="checkbox"/> 3 <input type="checkbox"/> 4	<input type="checkbox"/>
	MIN	0 kbits	0 kbits	<input type="checkbox"/> 1 <input type="checkbox"/> 2 <input type="checkbox"/> 3 <input type="checkbox"/> 4	<input type="checkbox"/>
	MIN	0 kbits	0 kbits	<input type="checkbox"/> 1 <input type="checkbox"/> 2 <input type="checkbox"/> 3 <input type="checkbox"/> 4	<input type="checkbox"/>
	MIN	0 kbits	0 kbits	<input type="checkbox"/> 1 <input type="checkbox"/> 2 <input type="checkbox"/> 3 <input type="checkbox"/> 4	<input type="checkbox"/>
	MIN	0 kbits	0 kbits	<input type="checkbox"/> 1 <input type="checkbox"/> 2 <input type="checkbox"/> 3 <input type="checkbox"/> 4	<input type="checkbox"/>
	MIN	0 kbits	0 kbits	<input type="checkbox"/> 1 <input type="checkbox"/> 2 <input type="checkbox"/> 3 <input type="checkbox"/> 4	<input type="checkbox"/>
	MIN	0 kbits	0 kbits	<input type="checkbox"/> 1 <input type="checkbox"/> 2 <input type="checkbox"/> 3 <input type="checkbox"/> 4	<input type="checkbox"/>
	MIN	0 kbits	0 kbits	<input type="checkbox"/> 1 <input type="checkbox"/> 2 <input type="checkbox"/> 3 <input type="checkbox"/> 4	<input type="checkbox"/>

Figure 3-24 QoS Setting

## 3.10 Load Balance

### 3.10.1 Outbound Load Balance

AirLive IGR-1500 provides three kinds of work mode for Outbound Load Balance, and Ultra Smart Sharing feature to offer intelligent connection solution for banking system and Internet on-line game server.

- **Session:** All the enabled WAN ports have the same bandwidth rate (1:1)
- **Weight round robin:** Configure the WAN port bandwidth rate manually.
- **Dynamic Traffic:** Router will find the lowest loading WAN port to transmit and receive data automatically
  
- **Session:** When user chooses this mode, the router will assign each coming session to each WAN port one by one, no matter how traffic loading is on each WAN port. (Figure 3-25)

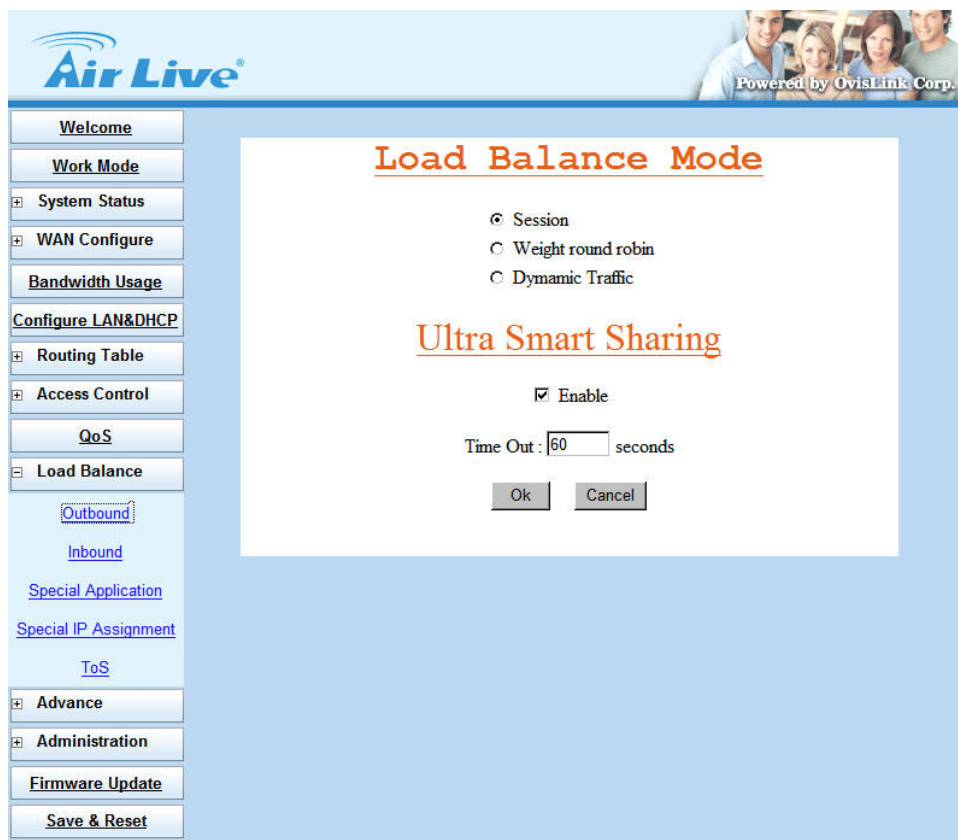

Figure 3-25 Outbound Load Balance – Session

- **Weight round robin:** Configure the WAN ports bandwidth rate manually, means you can distribute each coming session from users to each WAN port, following the rate that you assign in each WAN port. The session number in each WAN can be numbered from **1 to 100**, the suggest number is under 1 ~10. If rate is 1:1 for each WAN port, the router function will act like Session mode. (Figure 3-26)

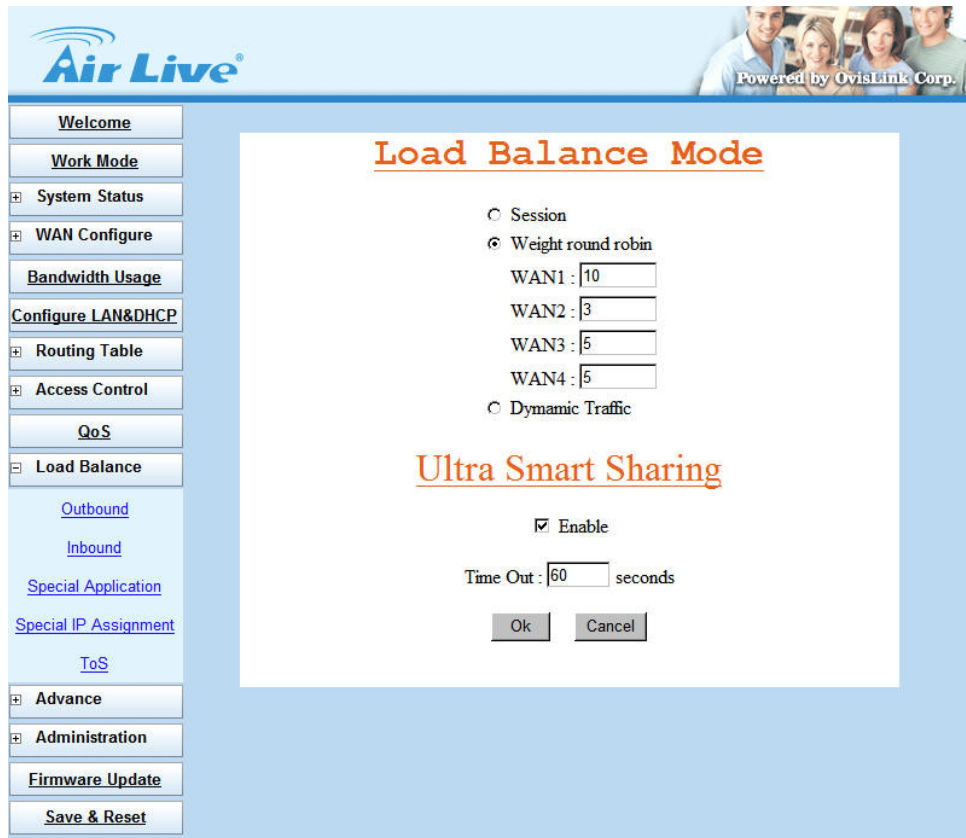

Figure 3-26 Outbound Load Balance – Weight round robin

- Dynamic Traffic:** Router will find the lowest loading WAN port to transmit and receive data automatically. You need to enter correct ADSL/CABLE WAN speed in here. (Figure 3-27)



Figure 3-27 Outbound Load Balance – Dynamic Traffic

- **Ultra Smart Sharing:** When user enables this function, IGR-1500 will lock user packet at dedicated WAN port, the dedicated WAN port will be selected base on 1st user packet (This feature is suitable for Game, VoIP, banking system ...etc). (Figure 3-28)
  - ◆ **Time out Timer:** Default is 60 second, range from 30 ~255. User will be removed from WAN user list if no user packet RX/TX passes through the dedicated WAN port after timer expired.



Figure 3-28 Outbound Load Balance – Ultra Smart Sharing

### 3.10.2 Inbound Load Balance

Inbound function can let you load sharing traffic that coming from Internet to access you intranet server via each WAN link, this function can increase WAN utilization. (Figure 3-29)

For more detail usage, please refer to **Appendix A**.



Figure 3-29 Inbound Load Balance



### 3.10.3 Special Application

Some Internet WEB server do not allow access with multi WAN address, also these WEB server was using dynamic IP address, in this case, AirLive IGR-1500 can let you just define dedicated port number allocated with dedicated WAN port, and the dedicated port was used to access these special WEB Server. (Figure 3-30)

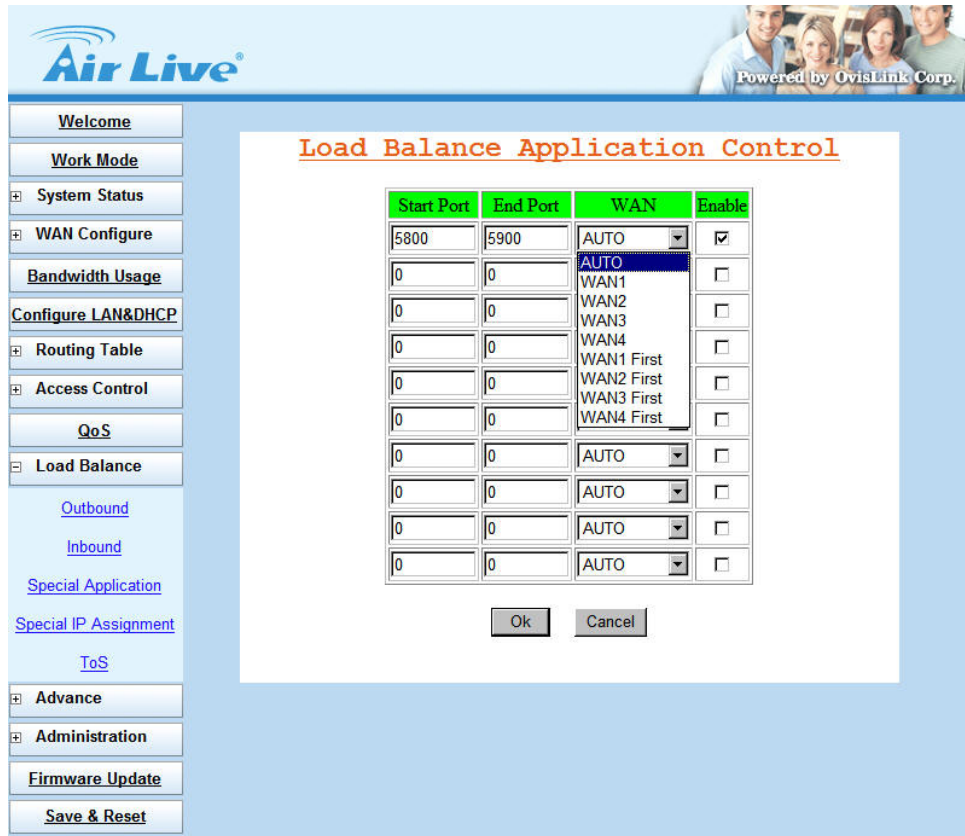

Figure 3-30 Special Application

### 3.10.4 Special IP Assignment

Same as above mentioned, AirLive IGR-1500 can let you defined dedicated IP address (destination IP address or Source IP address) allocated with dedicated WAN port. (Figure 3-31)

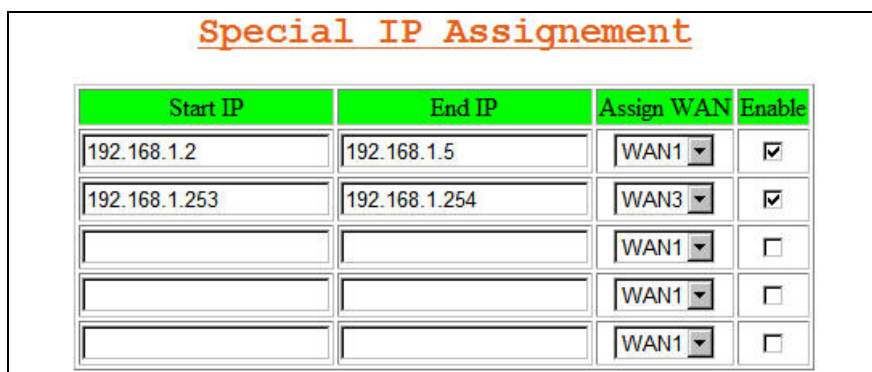

Figure 3-31 Special IP Assignment

### 3.10.5 TOS

TOS function can let you setting the priority for dedicated packet. (Figure 3-32)

User can specify the **Source IP**, **Destination IP**, **Protocol type**, **Source port number**, **Destination port number** and **Priority** for TOS feature. (Figure 3-33)

The screenshot shows the 'Air Live' web interface. The sidebar on the left contains the following menu items: Welcome, Work Mode, System Status, WAN Configure, Bandwidth Usage, Configure LAN&DHCP, Routing Table, Access Control, QoS, Load Balance, Outbound, Inbound, Special Application, Special IP Assignment, ToS, Advance, Administration, Firmware Update, and Save & Reset. The main content area is titled 'Configure ToS' and contains a 'ToS List' table. The table has the following data:

Status	Source IP/Port	Distination IP/Port	Potocol Type	Priority	Delete	Modify
enable	192.168.1.2~192.168.1.2 25~25	0.0.0.0~0.0.0.0 25~25	TCP	HIGH	<input type="checkbox"/>	<input type="checkbox"/>

Below the table are buttons for 'Add', 'Apply', and 'Cancel'.

Figure 3-32 TOS

The 'ToS Configuration' form contains the following fields and options:

- status :  Enable  Disable
- Source address : From  To
- Distination address : From  To
- Protocol Type :
- Source Port : From  To
- Distination Port : From  To
- Priority :

Buttons for 'Apply' and 'Cancel' are located at the bottom of the form.

Figure 3-33 TOS Configuration

## 3.11 Advance

### 3.11.1 Remote Configure

The AirLive IGR-1500 can be managed from any PC from Internet. If enable “Remote Configure” function, remote user can access the Web-based from router’s WAN interface via Internet; If “Remote Configure” does not enable, the access is only available to PCs from LAN. The accessed port number is changeable. (Figure 3-34)

- **Assigning Remote IP:** Specific dedicated PC can access IGR-1500 remotely.
  - ◆ Leaving these fields blank will allow access by all PCs
  - ◆ If enter specific IP address, only this address PC can access device remotely.
  - ◆ The address must be public IP addresses.

**Example:** If the local user:

Enable the remote configure function

Remote port is **80 (default is 80, can be different port number)**

Remote IP is blank.

ROUTER WAN port IP is **110.111.112.1**

When the user of remote side wants to access IGR-1500 web configure, the remote user only needs to enter **http:// 110.111.112.1**

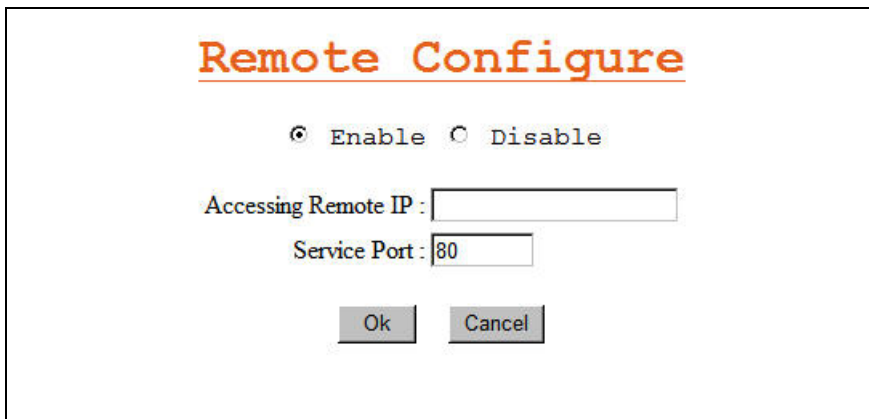

**Remote Configure**

Enable  Disable

Accessing Remote IP :

Service Port :

Figure 3-34 Remote Configure

### 3.11.2 Virtual Server

AirLive IGR-1500 ALG Options to allow IPsec, PPTP and VoIP pass-through, user can also define the port number for ALG Options.

You may have FTP, MAIL, VPN or other server on your LAN. If you would like to allow the global users access some servers providing special services on your LAN. This function can help you to do this.

Provide with global port & local port mapping function, let you easily configure internal server with same port number mapping to WAN IP different port number.

#### ALG Options:

- **VPN Pass Through:** For IPsec and PPTP
- **VoIP Pass Through:** VoIP Gateway can be connected directly to IGR-1500 LAN port, and open the corresponded VoIP port number.

(Figure 3-35)

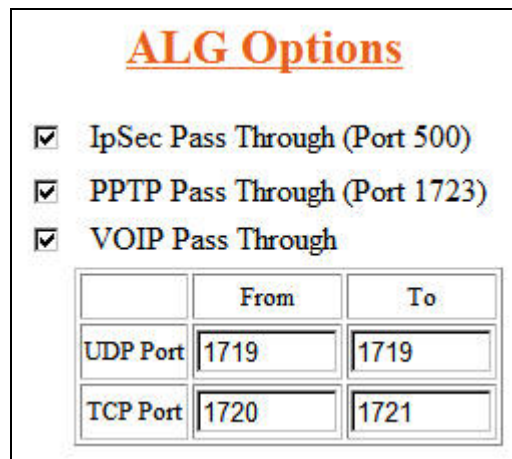

	From	To
UDP Port	1719	1719
TCP Port	1720	1721

Figure 3-35 ALG Options and Pass Through

#### Virtual Server:

- **Global port:** WAN virtual protocol number
- **Global IP:** WAN IP address
- **Local port:** used by internal server port number
- **Local IP:** local server IP address

(Figure 3-36)

## Virtual Server

ID	Global Port	Global IP	Local Port	Local IP	Enable
1	1020	60.250.158.65	21	192.168.1.10	<input checked="" type="checkbox"/>
2	2323	60.250.158.66	23	192.168.1.25	<input checked="" type="checkbox"/>
3	1100	59.124.2.55	110	192.168.1.13	<input checked="" type="checkbox"/>
4					<input type="checkbox"/>
5					<input type="checkbox"/>
6					<input type="checkbox"/>
7					<input type="checkbox"/>
8					<input type="checkbox"/>
9					<input type="checkbox"/>
10					<input type="checkbox"/>
11					<input type="checkbox"/>
12					<input type="checkbox"/>
13					<input type="checkbox"/>
14					<input type="checkbox"/>
15					<input type="checkbox"/>
16					<input type="checkbox"/>
17					<input type="checkbox"/>
18					<input type="checkbox"/>
19					<input type="checkbox"/>
20					<input type="checkbox"/>

If you don't know the **port number**, you can use following way to **get port number**.

Select Port:  Select ID:

Figure 3-36 Virtual Server

**For example:** (Figure 3-37)

Suppose you want to install servers dedicated with specific WAN port as following:

1. Internet user can access FTP server from WAN1
2. Internet user can access VNC from WAN 2.
3. Internet user can ERP server from all the WAN port.

**Environment:**

WAN1 IP address: Static IP address 60.250.158.64

WAN2 IP address: Static IP address 230.74.69.15

WAN3 IP address: Dynamic IP

WAN4 IP address: PPPoE

**LAN server:**

FTP server (TCP 21): 192.168.1.10

VNC client (TCP 5800, 5900): 192.168.1.50

ERP server (TCP 1394 ~ TCP 1400): 192.168.1.120

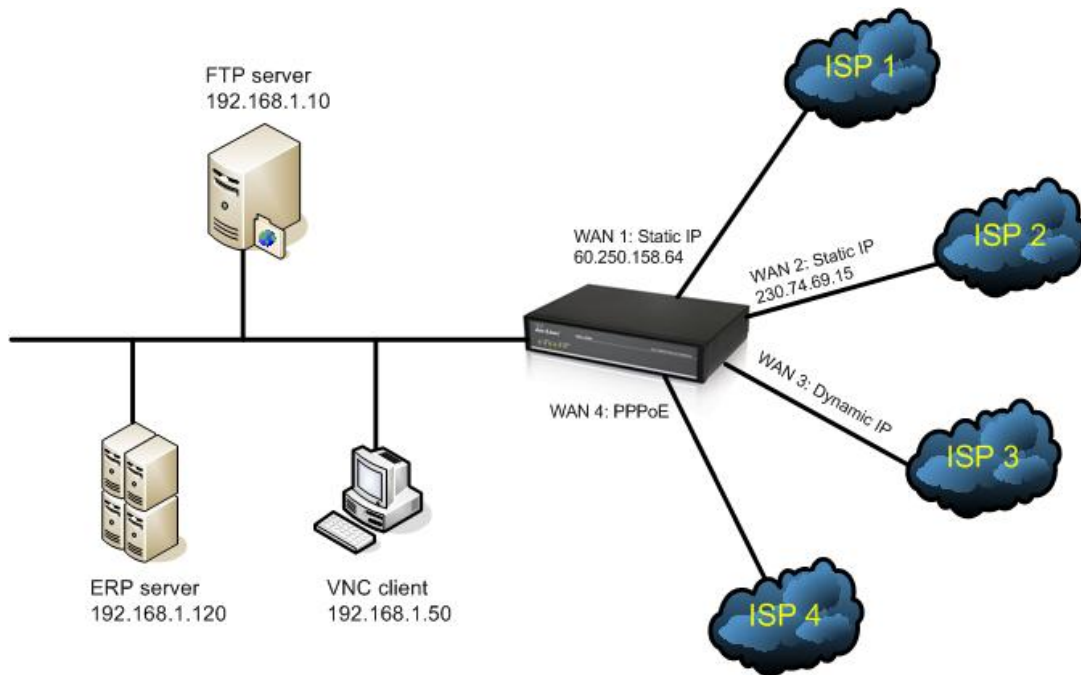

Figure 3-37 Example Topology

**Example 1:** Define Virtual server to allow FTP service (TCP 21) packets from Internet to LAN FTP server via WAN1. (Figure 3-38)

**Virtual Server**

ID	Global Port	Global IP	Local Port	Local IP	Enable
1	21	60.250.158.64	21	192.168.1.10	<input checked="" type="checkbox"/>
2					<input type="checkbox"/>
3					<input type="checkbox"/>
4					<input type="checkbox"/>
5					<input type="checkbox"/>
6					<input type="checkbox"/>
7					<input type="checkbox"/>
8					<input type="checkbox"/>
9					<input type="checkbox"/>
10					<input type="checkbox"/>

Figure 3-38 Example1 setting

**Example 2:** Define Virtual server to allow VNC service (TCP 5800, TCP 5900) packets from Internet to LAN VNC client via WAN2. (Figure 3-39)

### Virtual Server

ID	Global Port	Global IP	Local Port	Local IP	Enable
1	5800	230.74.69.15	5900	192.168.1.50	<input checked="" type="checkbox"/>
2	5900	230.74.69.15	5900	192.168.1.50	<input checked="" type="checkbox"/>
3					<input type="checkbox"/>
4					<input type="checkbox"/>
5					<input type="checkbox"/>
6					<input type="checkbox"/>
7					<input type="checkbox"/>
8					<input type="checkbox"/>
9					<input type="checkbox"/>
10					<input type="checkbox"/>

Figure 3-39 Example2 setting

**Example 3:** Define Virtual server to allow packets TCP 1394 ~ 1400 from Internet to ERP server via all the WAN interfaces. (Figure 3-40)

### Group Virtual Server

Start Port	End Port	Global IP	Local IP	TCP/UDP	Enable
1394	1400		192.168.1.120	TCP	<input checked="" type="checkbox"/>
0	0			BOTH	<input type="checkbox"/>
0	0			BOTH	<input type="checkbox"/>
0	0			BOTH	<input type="checkbox"/>
0	0			BOTH	<input type="checkbox"/>

Figure 3-40 Example3 setting

### 3.11.3 DMZ Host

The **Demilitarized Zone (DMZ)** function provides a way for public servers (Web, e-mail, FTP, etc.) to be visible to the outside world (while still being protected from DoS (Denial of Service) attacks such as SYN flooding and Ping of Death). These public servers can still be accessed from the secure LAN.

By default the firewall allows traffic between the WAN and the DMZ, and from the LAN to the DMZ, but traffic from the DMZ to the LAN is denied. Internet users can access to host servers configured in DMZ Host list, but can not access to the LAN, unless special filter rules were configured to permit the access by the administrator or the user who is an authorized remote user.

It is highly recommended that you keep all sensitive information off of the public servers, and store sensitive information in computers on LAN.

If you would like to grant remote users the right to access one of your computers on LAN to perform some actions such as Internet games, you must enable the function of DMZ. When remote users access your legal IP(s), IGR-1500 will transmit these packets to the corresponding virtual IP(s). (Figure 3-41)

The screenshot shows the 'Air Live' web interface. On the left is a navigation menu with options like 'Welcome', 'Work Mode', 'System Status', 'WAN Configure', 'Bandwidth Usage', 'Configure LAN&DHCP', 'Routing Table', 'Access Control', 'QoS', 'Load Balance', 'Advance', and 'Remote Configure'. The main content area is titled 'Dynamic IP DMZ' and contains four checkboxes for WAN1, WAN2, WAN3, and WAN4, each followed by a text input field for 'Host IP Address'. Below this is a section titled 'Multi-DMZ' which contains a table with 10 rows. Each row has columns for 'Item', 'DMZ Host IP Address', 'IP address provided by ISP', and 'Enable'.

Item	DMZ Host IP Address	IP address provided by ISP	Enable
1			<input type="checkbox"/>
2			<input type="checkbox"/>
3			<input type="checkbox"/>
4			<input type="checkbox"/>
5			<input type="checkbox"/>
6			<input type="checkbox"/>
7			<input type="checkbox"/>
8			<input type="checkbox"/>
9			<input type="checkbox"/>
10			<input type="checkbox"/>

Figure 3-41 Dynamic IP DMZ



■ **Dynamic IP DMZ:**

When a WAN port IP is assigned by ISP and obtained by PPPoE or Dynamic IP, you can use this section to specify the DMZ host disregarding the exact WAN IP address. Tick the WAN port option and fill in the IP address of the DMZ host inside the network, the IGR-1500 will map the corresponding WAN IP to the internal DMZ host automatically. When a remote computer wants to access the internal LAN through this WAN, if the accessed port number is not specified by Virtual Server Host, it will be mapped into this internal DMZ host. For example, if your WAN1 uses PPPoE connection to obtain a public IP address, the IGR-1500 will let data packet with destination address point to WAN1, and pass through into DMZ Host when the port number of the packet does not exist in Virtual Server Host table.

■ **Multi-DMZ:**

If you use fixed WAN IP address assigned by your ISP, you can use this section to specifically assign the WAN IP address to corresponding DMZ host. If you own several legal WAN IPs, you can assign which WAN IP correspond to which IP on your LAN. This assignment will let most protocol to access the assigned IP on the LAN. The following figure is an example: (Figure 3-42)



The screenshot shows the 'Multi-DMZ' configuration page in the Air Live web interface. The page has a navigation menu on the left and a main content area with a table. The table has the following data:

Item	DMZ Host IP Address	IP address provided by ISP	Enable
1	192.168.1.10	203.74.94.31	<input checked="" type="checkbox"/>
2	192.168.1.11	203.74.94.32	<input checked="" type="checkbox"/>
3	192.168.1.12	203.74.94.33	<input checked="" type="checkbox"/>
4			<input type="checkbox"/>
5			<input type="checkbox"/>
6			<input type="checkbox"/>
7			<input type="checkbox"/>
8			<input type="checkbox"/>
9			<input type="checkbox"/>
10			<input type="checkbox"/>
11			<input type="checkbox"/>
12			<input type="checkbox"/>
13			<input type="checkbox"/>

Figure 3-42 Multi-DMZ

### 3.11.4 Multi-NAT

Multi-NAT function allows you to configure multiple LAN IP domain to each WAN port (total 10 LAN IP can be defined), after configure multiple NAT function it will act like virtual router, all traffic between each LAN IP domain will be accessed through IGR-1500. It will provide following benefit:

- . \* restrict broadcast storm in single IP domain.
- . \* check each packet with DoS function enable.

- **LAN IP:** separated LAN IP domain
- **Subnet Mask:** mask for IP domain
- **WAN IP:** specific WAN IP address matched to LAN IP domain.
  - ◆ You can leave it **blank** in this field for PPPoE connection.
  - ◆ Write down specific WAN IP address, if WAN port had defined multiple IP address on it (DMZ used).
  - ◆ Blank: router will send packet follow by WAN filed selected.
- **WAN:** AUTO, WAN1, WAN2, WAN3, WAN4
  - ◆ WAN1/2/3/4: router will route packet to correspond LAN/WAN
  - ◆ AUTO: router will route packet follow by “load balance” function selected.

(Figure 3-43)

The screenshot displays the 'Multi-NAT' configuration page in the Air Live web interface. The page features a sidebar with navigation options and a main configuration area. The configuration area contains a table with the following columns: Item, LAN IP, Subnet MASK, WAN IP, WAN, and Enable. The table has 10 rows, each with a checkbox in the 'Enable' column and a dropdown menu in the 'WAN' column. The 'WAN' dropdowns are all set to 'AUTO'. Below the table are 'Ok' and 'Cancel' buttons.

Item	LAN IP	Subnet MASK	WAN IP	WAN	Enable
1				AUTO	<input type="checkbox"/>
2				AUTO	<input type="checkbox"/>
3				AUTO	<input type="checkbox"/>
4				AUTO	<input type="checkbox"/>
5				AUTO	<input type="checkbox"/>
6				AUTO	<input type="checkbox"/>
7				AUTO	<input type="checkbox"/>
8				AUTO	<input type="checkbox"/>
9				AUTO	<input type="checkbox"/>
10				AUTO	<input type="checkbox"/>

Figure 3-43 Multi-NAT

### 3.11.5 IP Binding

In Internet world, there have some Game Server, SSL protocol user or Personal Server have special request for connection, these special request include:

- **Use special port number to perform specific function**
- **Not allow user connect with multiple WAN IP address**

For Example, if user uses load Balance function provided by router to connect Server, Server might respond with many login requests back to user, because each session comes different WAN port with different IP address, Server treats it like different request

When user enables IP Binding function, he can specify the IP packet with dedicated WAN port to reach dedicated destination server, so it will show only 1 IP address.

That means when user wants to reach destination server, the packet will only go through dedicated WAN port, so load balance function will not be available.

- **Remote IP:** Destination server IP address. It will be restrict the access via dedicated WAN port. If you do not specify destination Host IP address in this field, the specific port number in the port number field will be limited to transfer packet via dedicated WAN port.
- **Start Port / End Port:** The protocol port number starts from 0 to 65535, you can decide the port number range to be restricted.
  - ◆ **Start Port / End Port: 0** – all packet will be restricted to dedicated WAN port
  - ◆ **Start Port / End Port: blank** – all packet will be restricted to dedicated WAN port
  - ◆ **Start Port / End Port: 80** – only packet type of port 80 will be restricted, the rest type packets will not be restricted, and can be spread out with Load Balance function.
  - ◆ **Start Port / End Port: 1 ~ 21** – only packet type from port 1 to port 21 will be restricted, the rest type packets will not be restricted, and can be spread out with load balance function.
- **WAN:** select WAN port for transferring the dedicated destination packet

**Example:**

<u>IP Address</u>	<u>Start port</u>	<u>End Port</u>	<u>WAN</u>
210.3.1.23	0	65535	WAN1

All packets go to Internet Host with IP 210.3.1.23 will be restricted to dedicated WAN 1

<u>IP Address</u>	<u>Start port</u>	<u>End Port</u>	<u>WAN</u>
210.3.1.24	23	23	WAN2

Packet type belong to protocol 23 that goes to Internet Host with IP 210.3.1.24 will be restricted to dedicated WAN2

<u>IP Address</u>	<u>Start port</u>	<u>End Port</u>	<u>WAN</u>
Blank	21	21	WAN1

Packet type belong to protocol 21 (FTP) that goes to any of Internet Host will be restricted to dedicated WAN1.  
(Figure 3-44)



**Figure 3-44 IP Binding**

### 3.11.6 DDNS (Gateway mode and Basic NAT mode only)

You need to apply for a free DNS domain name from [www.dyndns.org](http://www.dyndns.org) or the other DDNS service provider, AirLive IGR-1500 will update the WAN IP address to DDNS database once the WAN port was connected to Internet if DDNS function is enabled. And the users in Internet can find out the IGR-1500 via this domain name. (Figure 3-45)

- **DDNS:** select to enable DDNS service
- **WAN Port:** select the dedicated WAN port for DDNS service
- **Provider:** select the DDNS service provider that you want to apply the DDNS service, IGR-1500 provides [www.oray.net](http://www.oray.net), [www.88ip.com](http://www.88ip.com), [www.dyndns.org](http://www.dyndns.org), and [www.dtdns.com](http://www.dtdns.com) DDNS service provider.
  - ◆ **System:** IGR-1500 supports to define DynDNS DDNS service as DDNS resolved Dynamic IP, DDNS resolved Static IP, or DDNS resolved Custom IP.
- **User Name:** Enter the user name applied from DDNS service provider
- **Password:** Enter the password applied from DDNS service provider
- **User Hostname:** Enter the host name applied from DDNS service provider

The screenshot shows the 'Dynamic DNS' configuration page in the AirLive web interface. The page has a blue header with the 'Air Live' logo and a family photo. A left sidebar contains navigation menus: 'Welcome', 'Work Mode', 'System Status', 'WAN Configure', 'Bandwidth Usage', 'Configure LAN&DHCP', 'Routing Table', 'Access Control', 'QoS', 'Load Balance', 'Advance', and 'Remote Configure' (with sub-items: Virtual Server, DMZ Host, Multi-NAT, IP Binding, DDNS). The main content area is titled 'Dynamic DNS' and contains the following configuration fields:

- DDNS :  Enable  Disable
- Wan Port :  (dropdown)
- System :  Dynamic  Static  Custom
- Provider :  (dropdown)
- User Name :
- Password :
- User Hostname :   (dropdown)

At the bottom of the form are 'OK' and 'Cancel' buttons.

Figure 3-45 DDNS

### 3.11.7 Proxy (Gateway mode and Basic NAT mode only)

This function works together with **Mail Alert** function, if there have Proxy Server in your local LAN, please fill in necessary Proxy information in this display. (Figure 3-46)



Figure 3-46 Proxy

### 3.11.8 Mail Alert (Gateway mode and Basic NAT mode only)

Enter the **Receiver/ Sender** e-mail Address in the fields and check the items you want. System will send e-mails to **Receiver** address once the conditions meets the setting. (Figure 3-47)

- **Receiver mail address:** The mail address that will receive alert mail
- **Sender mail address:** The mail address that send out alert mail, you should fill in a legal format address
- **Alert Condition:** IGR-1500 provides four condition selections:

<b>WAN Up</b>	System will send the mail, once WAN port(s) is connected to Internet.
<b>WAN Down</b>	System will send the mail, once WAN port(s) is disconnected from Internet.
<b>DoS Attack</b>	System will send the mail, once the selected conditions in DoS occurred. ( need to enable DoS function)
<b>System log</b>	System will send the mail of log information, once the log records conform to your setting.

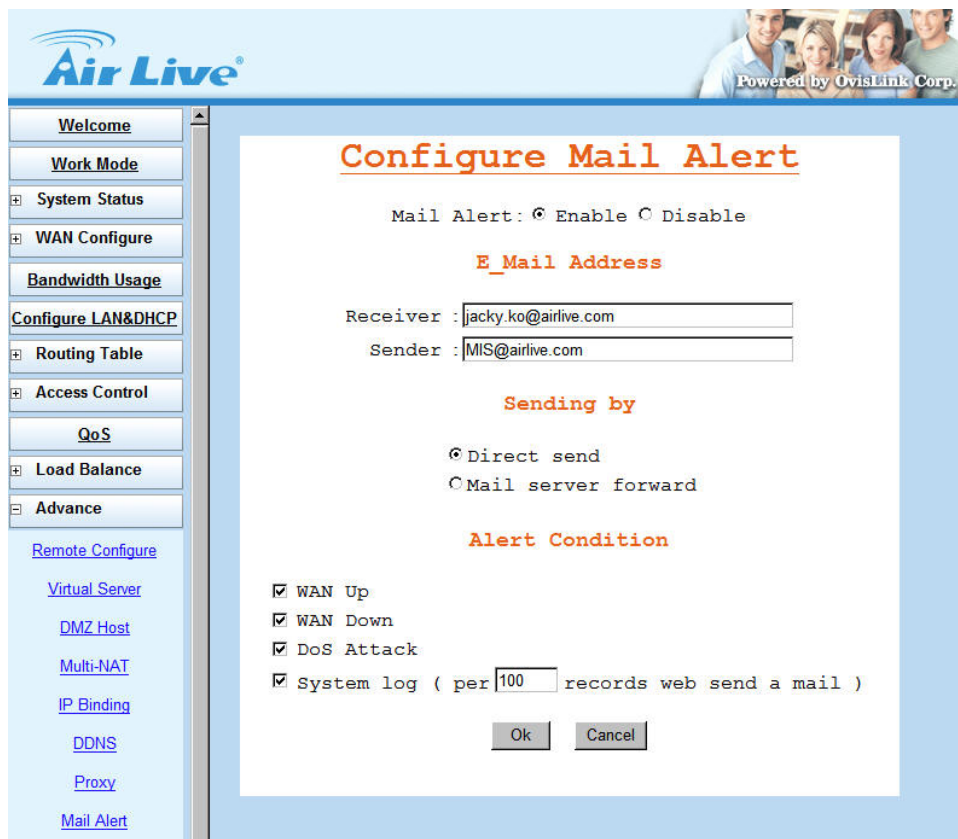

Figure 3-47 Mail Alert

### 3.11.9 Time (Gateway mode and Basic NAT mode only)

AirLive IGR-1500 will obtain the GMT (Greenwich Mean Time) after connected to Internet. You need to indicate the local time so that the system could operate with the correct time. For example, Taiwan's local time is GMT + 8 hours.

Select "Automatic adjust clock for daylight saving changes" will display the time one hour earlier than local time. (Figure 3-48)

The screenshot shows the AirLive web interface. The top header features the AirLive logo and a photo of a family with the text "Powered by OvisLink Corp.". A sidebar on the left contains a menu with the following items: Welcome, Work Mode, System Status, WAN Configure, Bandwidth Usage, Configure LAN&DHCP, Routing Table, Access Control, QoS, Load Balance, Advance, Remote Configure, Virtual Server, DMZ Host, Multi-NAT, IP Binding, DDNS, Proxy, Mail Alert, and Time. The main content area is titled "Time Zone" and contains the following configuration options:

- Automatic adjust clock for daylight saving changes
- Time Zone:
- Update from :  NTP  PC
- Select NTP Server
- Primary Server :
- Second Server :
- Current Time :
- 

Figure 3-48 Time



### 3.11.10 System Log (Gateway mode and Basic NAT mode only)

Show all the records after IGR-1500 Power on, such as WAN port up/down, WAN IP address, the obtained time, DDNS current corresponding WAN IP address and so forth. You can also save these data to files.

(Figure 3-49)

The screenshot displays the 'System Log' page in the Air Live web interface. The page features a navigation sidebar on the left with various configuration options. The main content area shows a table of log entries with the following data:

Item	Time	Content
1	1970-01-01 00:00	WAN1 Cable On 100M full
2	1970-01-01 00:00	WAN1 DHCP client start.
3	1970-01-01 00:00	Gateway 1 exist (192.168.0.254)
4	1970-01-01 00:00	WAN1 UP IP = 192.168.0.66
5	1970-01-01 00:00	LB_HC WAN1 restarted
6	2007-08-31 10:30	SNTPS Updated system Time Ok
7	2007-08-31 10:30	Schedule control is Updated !

Below the table, there is a 'Home Page' button.

Figure 3-49 System Log

### 3.11.11 MAC Address Clone

If your ISP blocked the MAC address of a network card, you may use MAC Address Clone to duplicate the MAC address to the Mac address in each WAN port.

Remove all Ethernet cable on IGR-1500 LAN port except for the PC you want to clone. Then press **Ok** when you ready. (Figure 3-50)

- **User Self-Define WAN Port MAC Address:** type in a MAC Address to define WAN MAC Address.
- **Set WAN Port MAC Address Equal PC MAC Address:** select to clone WAN MAC Address from LAN PC MAC Address.

You need to **reboot** IGR-1500 after finished cloning to make new MAC address takes effects.

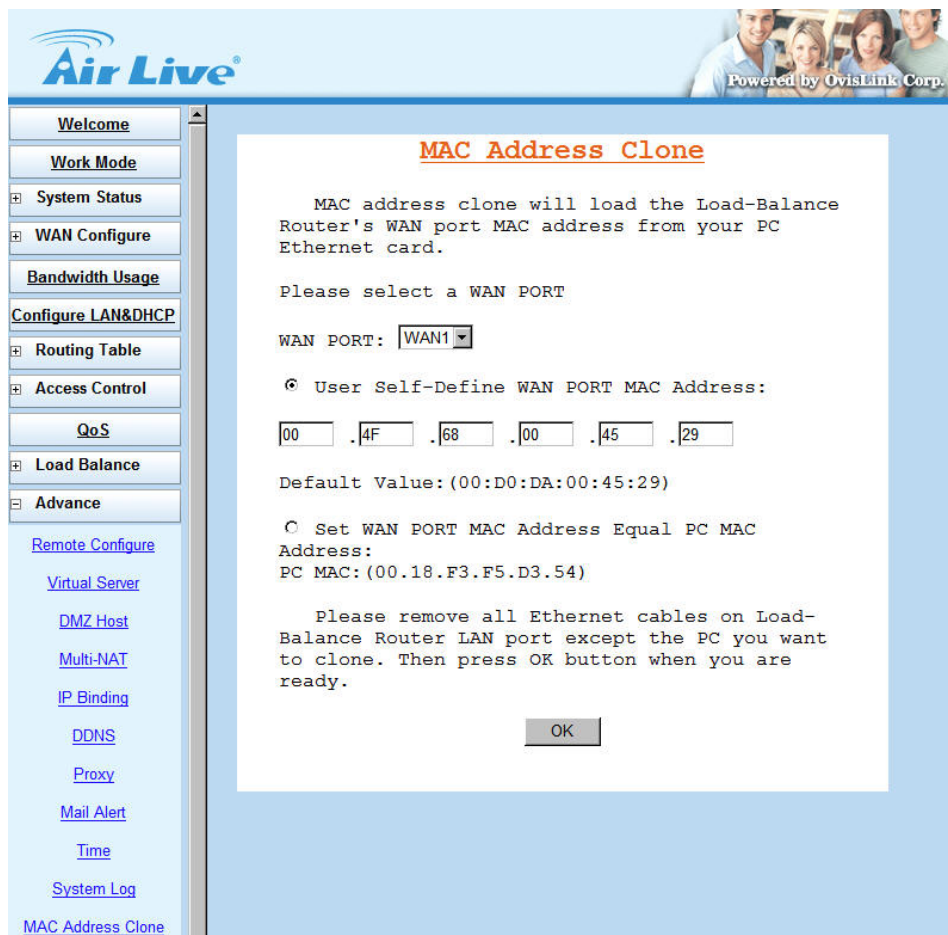

Figure 3-50 MAC Address Clone

## 3.12 Administrator

### 3.12.1 Password

Use this function to change the **Password** that is used for access the web configuration. Type in the **Old Password**, **New Password** and **Retype Password** in their respective fields and then click **Ok**, the password will be changed to new one after re-boot. (Figure 3-51)



Password length can be up to 30 alphanumeric characters with case sensitive.



**WE SUGGESTED YOU TO CHANGE ROUTER PASSWORD AND KEEP IT IN SAFETY PLACE AFTER YOU RECEIVED ROUTER AND FINISH ALL ROUTER PARAMETER SETTING.**

The screenshot shows the 'Air Live' web interface. On the left is a navigation menu with items: Welcome, Work Mode, System Status, WAN Configure, Bandwidth Usage, Configure LAN&DHCP, Routing Table, Access Control, QoS, Load Balance, Advance, Administration, and Password. The main content area displays the 'Change System Password' form with three input fields for 'Old Password', 'New Password', and 'Retype Password', each containing six dots. Below the fields are 'Ok' and 'Cancel' buttons. The top right of the interface features a family photo and the text 'Powered by OvisLink Corp.'

Figure 3-51 Change Password

### 3.12.2 Backup & Restore

Use **Backup & Restore** function to save all the settings parameters to PC for safety issue, in order to avoid all parameter lose when system crashes. (Figure 3-52)

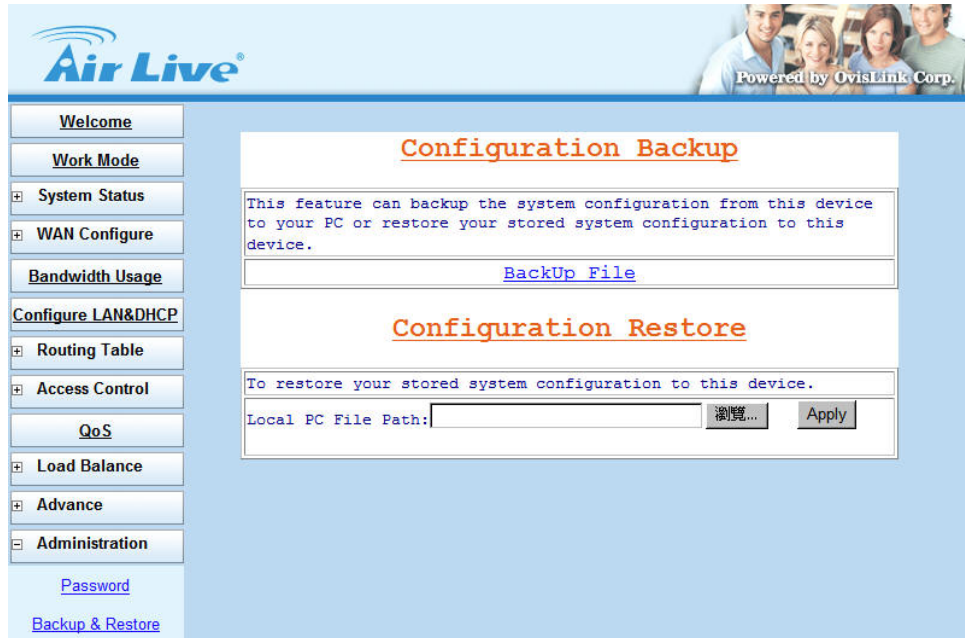

Figure 3-52 Backup & Restore

### 3.12.3 Load Factory Default

User can use this function to define the feature of reset button, or load the latest configuration file back to device. Click OK after the selection, the IGR-1500 will restart automatically. (Figure 3-53)

- **Reset Button Option:** This option is used to define Default button on the back penal of the router.
  - ◆ **Load Default:** press Reset button, the factory default configuration will be loaded.
  - ◆ **Reset:** press Reset button, IGR-1500 will reboot and load the latest configuration.
- **Load Factory Default:** Tick “**Yes**” option then click “**OK**”, you can load the factory default value immediately. If you only want to submit new setting for Default Button Option without load the factory default, tick the “**No**” option before click Ok.

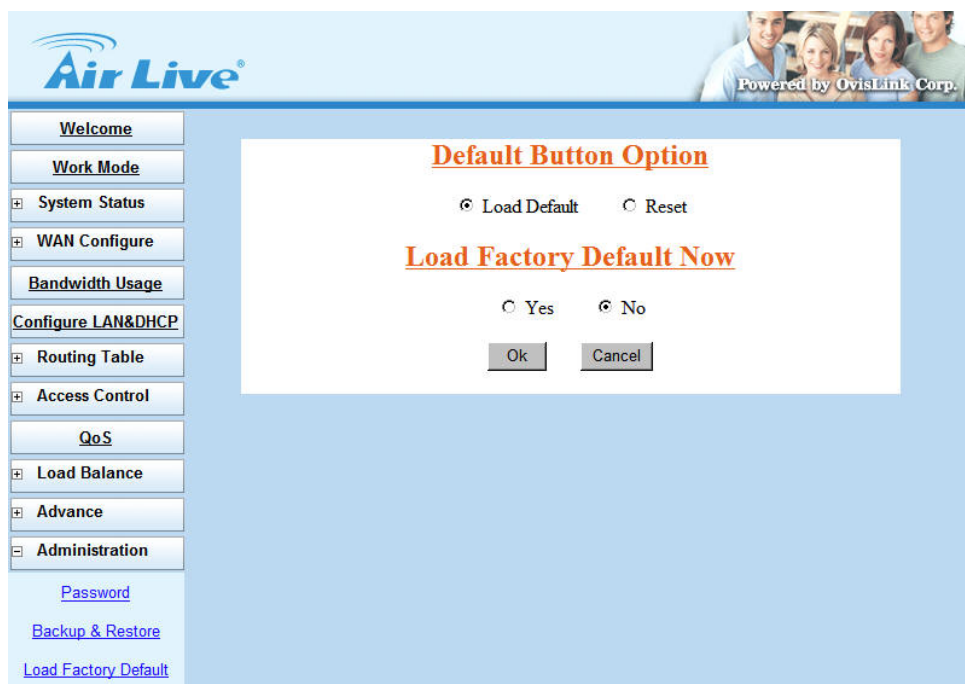
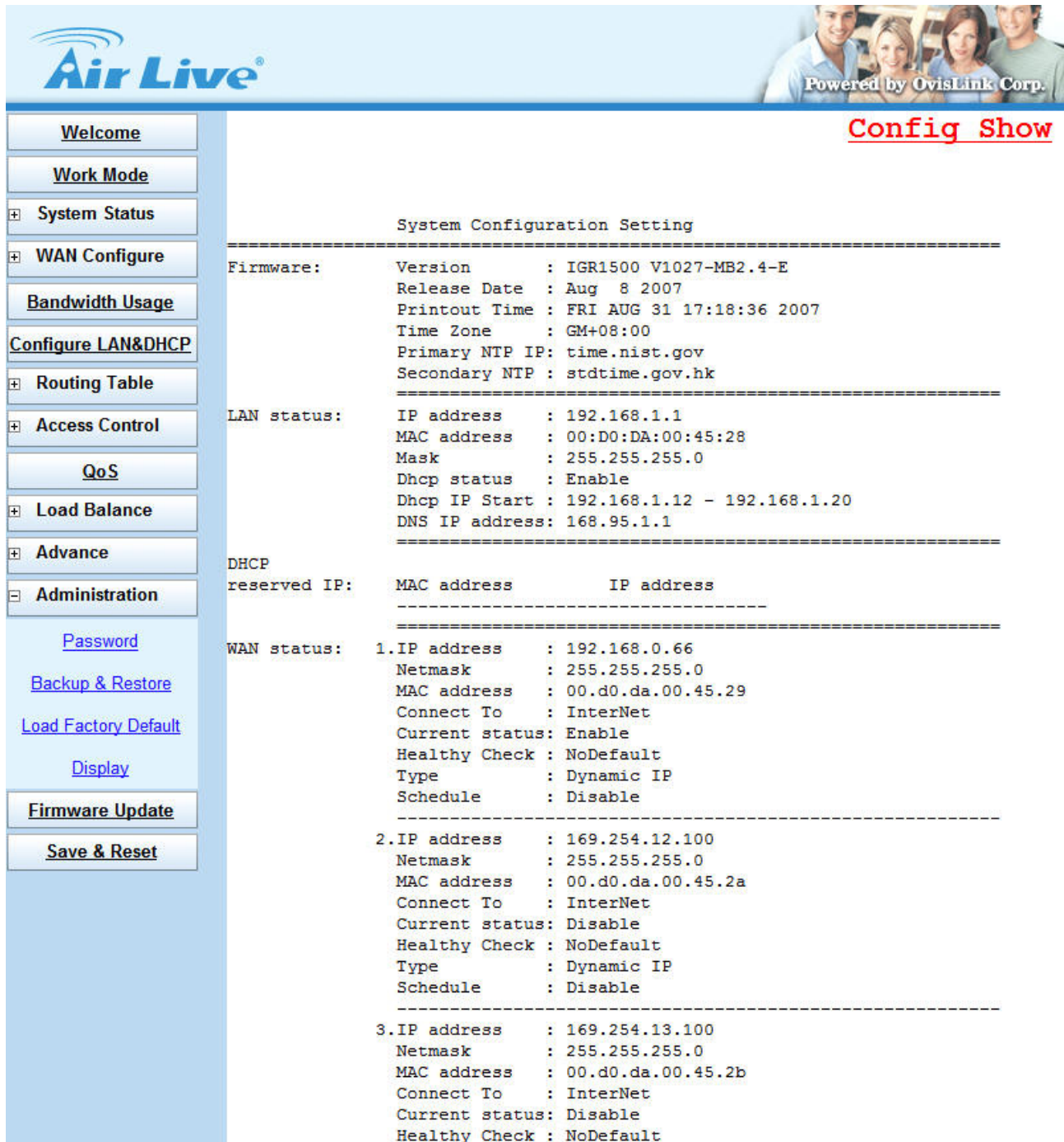

Figure 3-53 Load Factory Default

### 3.12.4 Display

You can use this function to check all the parameter setting in this router, in order to save time to check every display. (Figure 3-54)



**Air Live** Powered by OvisLink Corp.

**Config Show**

<ul style="list-style-type: none"> <li><a href="#">Welcome</a></li> <li><a href="#">Work Mode</a></li> <li><input checked="" type="checkbox"/> <a href="#">System Status</a></li> <li><input checked="" type="checkbox"/> <a href="#">WAN Configure</a></li> <li><a href="#">Bandwidth Usage</a></li> <li><a href="#">Configure LAN&amp;DHCP</a></li> <li><input checked="" type="checkbox"/> <a href="#">Routing Table</a></li> <li><input checked="" type="checkbox"/> <a href="#">Access Control</a></li> <li><a href="#">QoS</a></li> <li><input checked="" type="checkbox"/> <a href="#">Load Balance</a></li> <li><input checked="" type="checkbox"/> <a href="#">Advance</a></li> <li><input checked="" type="checkbox"/> <a href="#">Administration</a></li> <li><a href="#">Password</a></li> <li><a href="#">Backup &amp; Restore</a></li> <li><a href="#">Load Factory Default</a></li> <li><a href="#">Display</a></li> <li><a href="#">Firmware Update</a></li> <li><a href="#">Save &amp; Reset</a></li> </ul>	<p style="text-align: center;">System Configuration Setting</p> <hr/> <p>Firmware:      Version        : IGR1500 V1027-MB2.4-E                           Release Date    : Aug 8 2007                           Printout Time   : FRI AUG 31 17:18:36 2007                           Time Zone        : GM+08:00                           Primary NTP IP: time.nist.gov                           Secondary NTP : stdtime.gov.hk</p> <hr/> <p>LAN status:    IP address     : 192.168.1.1                           MAC address    : 00:D0:DA:00:45:28                           Mask            : 255.255.255.0                           Dhcp status    : Enable                           Dhcp IP Start : 192.168.1.12 - 192.168.1.20                           DNS IP address: 168.95.1.1</p> <hr/> <p>DHCP          reserved IP:    MAC address        IP address          -----</p> <hr/> <p>WAN status:    1. IP address     : 192.168.0.66                           Netmask         : 255.255.255.0                           MAC address    : 00.d0.da.00.45.29                           Connect To     : InterNet                           Current status: Enable                           Healthy Check : NoDefault                           Type            : Dynamic IP                           Schedule       : Disable</p> <hr/> <p>                 2. IP address     : 169.254.12.100                           Netmask         : 255.255.255.0                           MAC address    : 00.d0.da.00.45.2a                           Connect To     : InterNet                           Current status: Disable                           Healthy Check : NoDefault                           Type            : Dynamic IP                           Schedule       : Disable</p> <hr/> <p>                 3. IP address     : 169.254.13.100                           Netmask         : 255.255.255.0                           MAC address    : 00.d0.da.00.45.2b                           Connect To     : InterNet                           Current status: Disable                           Healthy Check : NoDefault</p>
------------------------------------------------------------------------------------------------------------------------------------------------------------------------------------------------------------------------------------------------------------------------------------------------------------------------------------------------------------------------------------------------------------------------------------------------------------------------------------------------------------------------------------------------------------------------------------------------------------------------------------------------------------------------------------------------------------------------------------------------------------------------------------------------------------------------------------------------------------------------------------------------------------------------------------------------------------------------------------------------------------------------------	---------------------------------------------------------------------------------------------------------------------------------------------------------------------------------------------------------------------------------------------------------------------------------------------------------------------------------------------------------------------------------------------------------------------------------------------------------------------------------------------------------------------------------------------------------------------------------------------------------------------------------------------------------------------------------------------------------------------------------------------------------------------------------------------------------------------------------------------------------------------------------------------------------------------------------------------------------------------------------------------------------------------------------------------------------------------------------------------------------------------------------------------------------------------------------------------------------------------------------------------------------------------------------------------------------------------------------------------------------------------------------------------------------------------------------------------------------------------------------------------------------------------------------------------------------------------------------------------------------------------------------------------------------------------------------------------------------------------------------------------------------------------------------------------------------------------------------------------------------------------------------------------------------------------------------------------------------------------------------------------------------------------------------------------------------------------------------------------------------------------------------------------------------------------------------------------------------------------------------------------------------------------------------------------

Figure 3-54 Display

### 3.13 Firmware Upgrade

AirLive IGR-1500 allows you to easily update the embedded firmware.

We will occasionally provide new firmware on the web site to help you updating the firmware of your IGR-1500.

Follow the procedure to update your firmware after downloaded the new code.

#### **Method 1:**

Double click the executable file (the file with exe extension file name) you downloaded. Here we take **v105.exe** as the example of new version file.

**Step 1:** Click **Search** to find the IP of router.



**Step 2:** The IP address of IGR-1500 is **192.168.1.1** (default value).

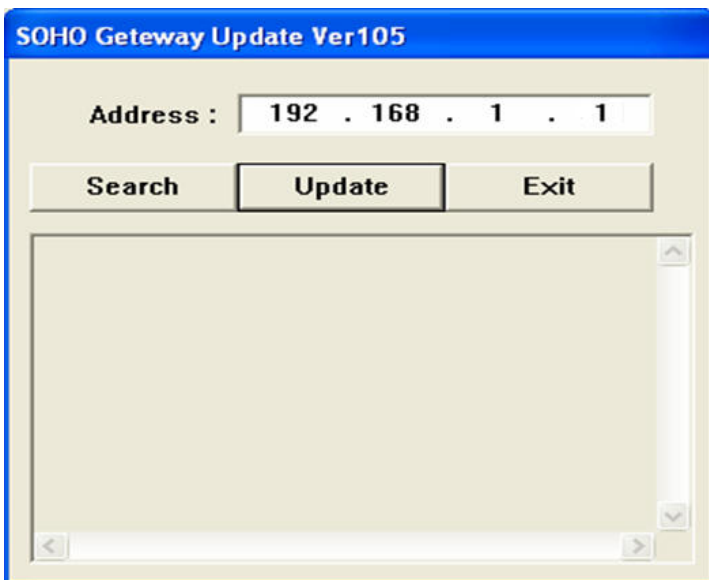

Step 3: Click **Update** to update the firmware.

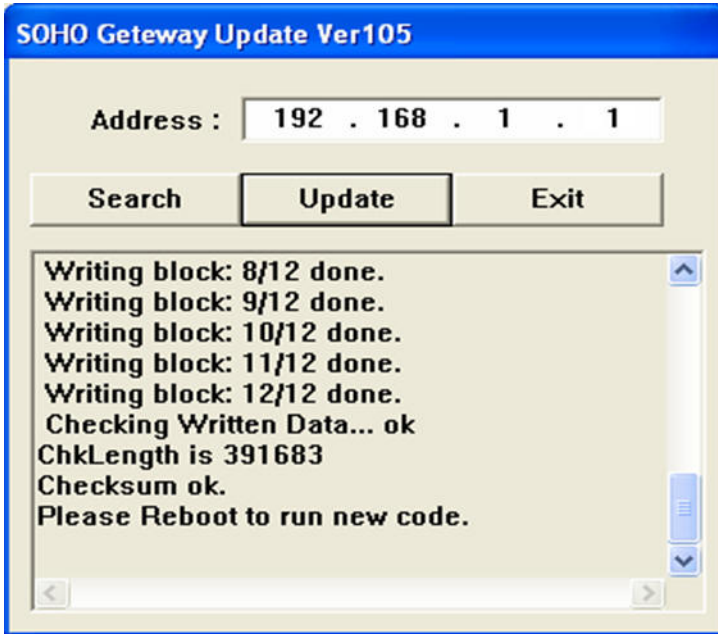

**Method 2:**

**Step 1:** Run a TFTP server program such as TFTP32. (TFTP32 is a shareware and you may download it or other TFTP server programs from Internet.)

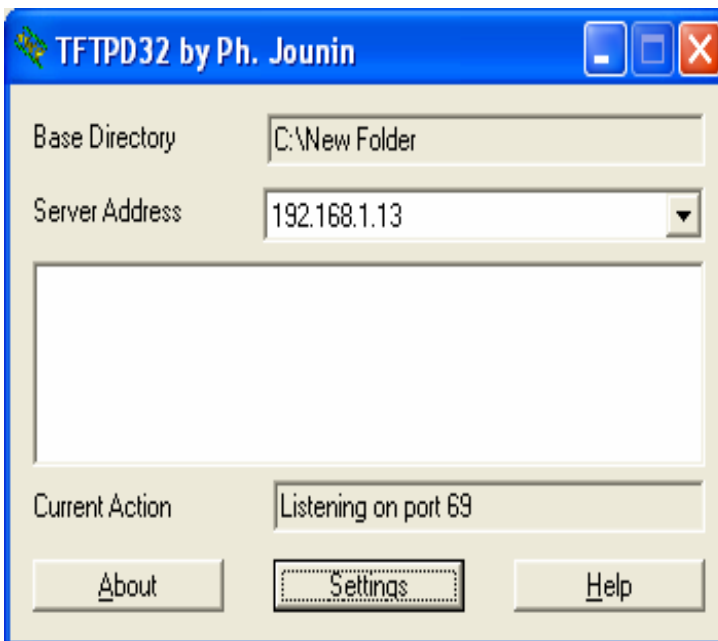



**Step2:** Make a base directory in this server

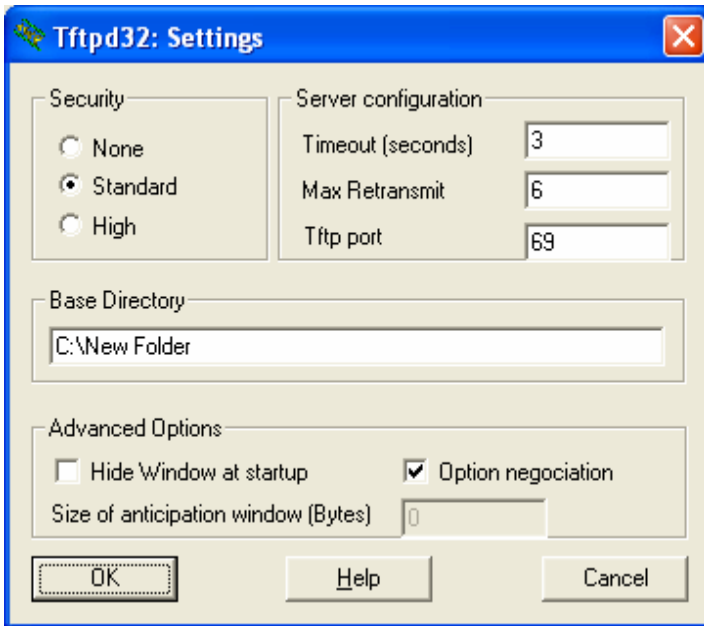

**Step 3:** Save the image file of firmware to the directory of TFTP32

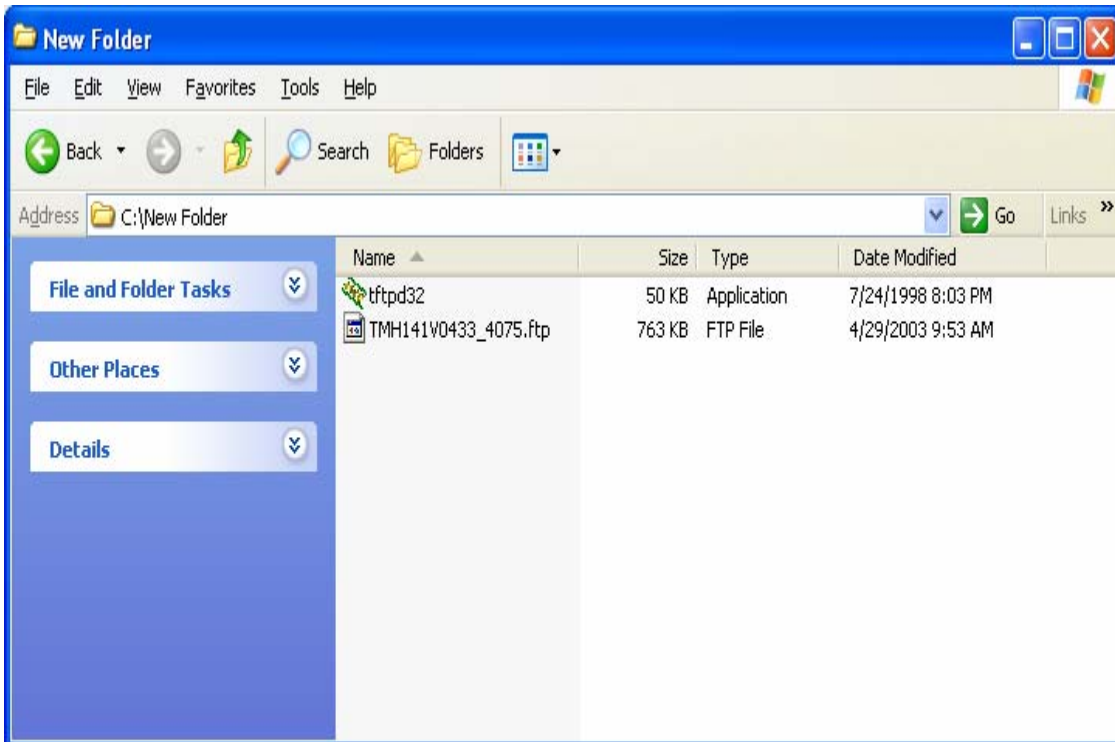

**Step 4:** Enter the **Server Name** and **File Name** in the new folder fields of **Firmware Update** window and then click **Ok**.

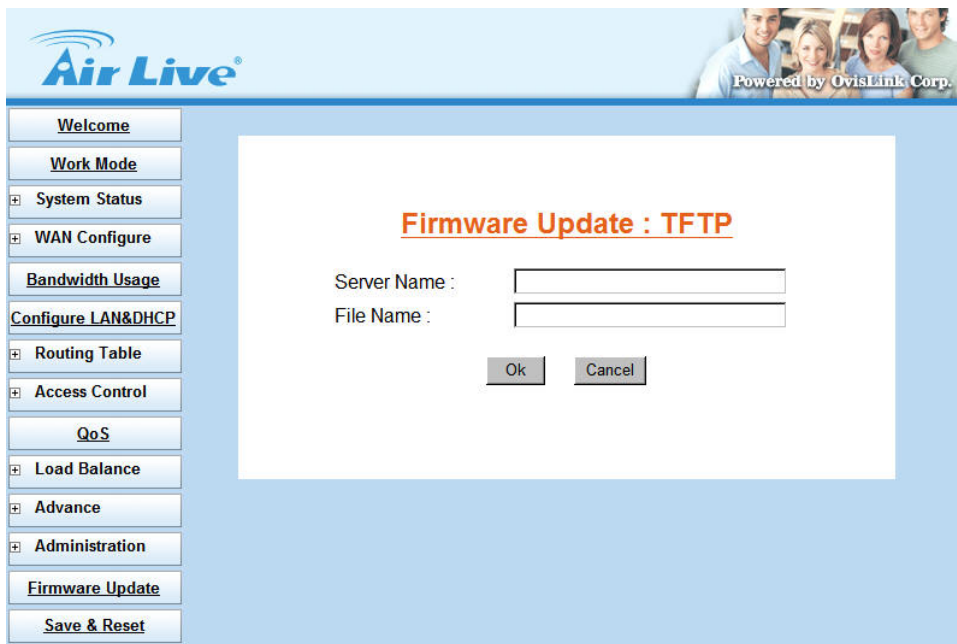

The screenshot shows the Air Live web interface. At the top left is the "Air Live" logo. At the top right is a photo of four people and the text "Powered by OvisLink Corp.". On the left side, there is a vertical menu with the following items: Welcome, Work Mode, System Status, WAN Configure, Bandwidth Usage, Configure LAN&DHCP, Routing Table, Access Control, QoS, Load Balance, Advance, Administration, Firmware Update (highlighted), and Save & Reset. The main content area displays a "Firmware Update : TFTP" window. This window has two input fields: "Server Name :" and "File Name :". Below these fields are two buttons: "Ok" and "Cancel".

**Step 5:** You will see the updating processing. After finishing update procedure, you must **reboot** IGR-1500 to run new code.

### 3.14 Save & Reset

In order to save the configuration changes that have been made to the IGR-1500, you must save them to the IGR-1500's Flash memory. If you do not save the changes, the configuration settings will be lost in the event of a power loss or system reboot to the IGR-1500. (Figure 3-55)

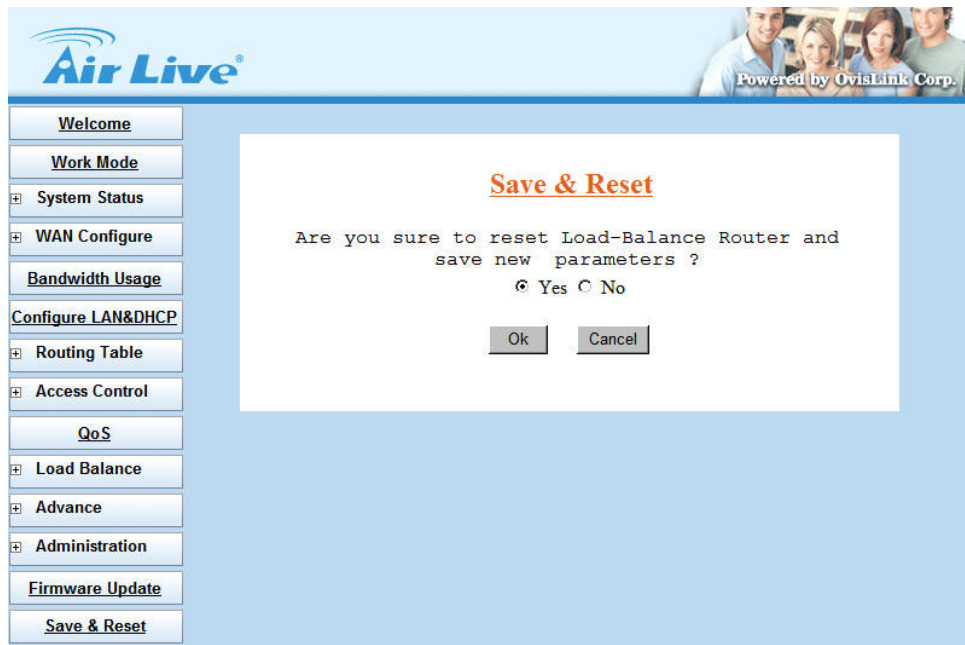

Figure 3-55 Load Factory Default

## Appendix A In-Bound Load Balance Function

Authorities DNS is just a fancy term for the official IP address keeper/provider of particular Domain (or Internet) name, such as [www.example.com](http://www.example.com) is analogous to a telephone book where a person's name is associated with his telephone number. Wikipedia, the free encyclopedia has a good general discussion of DNS: [http://en.wikipedia.org/wiki/Domain\\_Name\\_System](http://en.wikipedia.org/wiki/Domain_Name_System).

This IN-BOUND ROUTER DNS server contains the names and Internet addresses of servers that you wish to host. In order for all DNS requests of your domain names to be ultimately routed to your IN-BOUND ROUTER, it has to be setup at the registrar of your Internet name. In general, logon to your registrar site, and manage your domain name. For example, [www.example.com](http://www.example.com) is located at a WEB hosting company, and the original Domain server was registered in listed order:

NS0.DNSMADEEASY.COM      NS1.DNSMADEEASY.COM      NS2.DNSMADEEASY.COM  
NS3.DNSMADEEASY.COM      NS4.DNSMADEEASY.COM

We need to change [www.example.com](http://www.example.com) to be hosted by IN-BOUND ROUTER; so we follow the registrar's instructions and delete: NS2, NS3, and NS4, and assign Domain server:

Name	IP address
NS0.EXAMPLE.COM	WAN1
NS1.EXAMPLE.COM	WAN2

The name is arbitrary; the most important are about the IP addresses. It is absolutely necessary for WAN1 to be a static address, and for redundant, fault-tolerant accesses, WAN2 should also be a static address. It would take approximately 24 – 48 hours for this change to take effect throughout the Internet. Below is the actual display of godaddy for Name Servers:

If you will be using other Name Servers, please select Custom Name Servers and enter them in the spaces provided.

**Changes to Name Servers may take up to 48 hours to take effect.**

Default Hosting Name Servers  
 Default Parked Name Servers  
 Custom Name Servers

Name Server 1:  \*

Name Server 2:  \*

Name Server 3:

Name Server 4:

All registrars have the same basic name server facility. For [www.example.com](http://www.example.com), we use [godaddy.com](http://godaddy.com), and the process is: Login Manage domain Set Name Servers. We enter WAN1 and WAN2 for Custom Name Servers.

## A.1 Simple Load Balance (2 WAN lines; Session 1:1)

Let us assume that the upload speed of WAN1 and WAN2 are the same; so we will use inbound load-balancing setting: Session with a load-balancing ratio of 1:1.

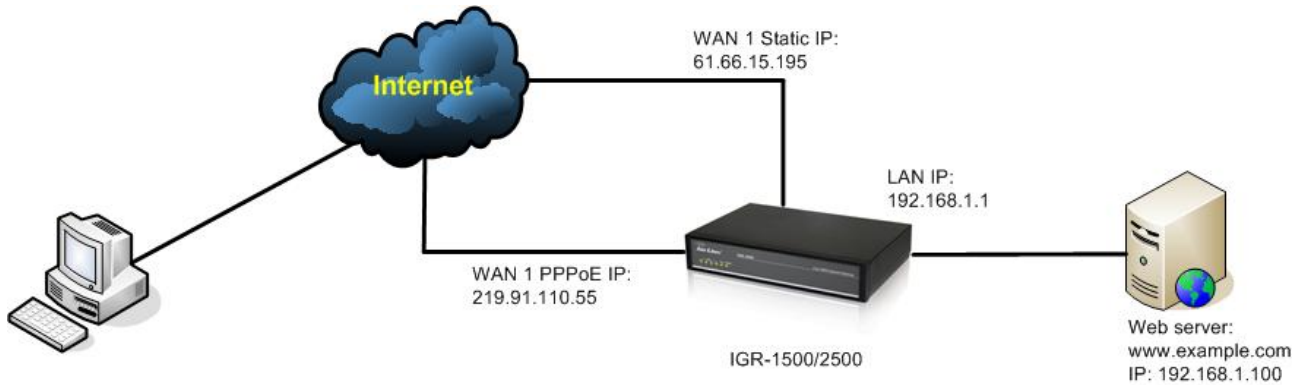

In the IN-BOUND ROUTER configuration **Load Balance** → **Inbound**:

## InBound Load Balance

**Load Balance Mode**

Session  
 Weight round robin

**Inbound Option**

Name	Type	Address	Modify	Delete
------	------	---------	--------	--------

Add new item

Apply Cancel

**Step 1:**  
Click on **Add new item**

## Configure Inbound (Addr)

### Select DNS Type

<input checked="" type="radio"/>	Address
<input type="radio"/>	Canonical Name
<input type="radio"/>	Mail eXchanger

Name :

IP Address :

Address :

### Step 2:

Enter host1.example.com two times, once for WAN1 and once for WAN2 with **Address** Type. This display show the 1st time for WAN1, after clicking **Ok**. Repeat the previous configuration with the same name for WAN2 at this time.

You don't need to explicitly enter any IP address.

## InBound Load Balance

### Load Balance Mode

- Session
- Weight round robin

### Inbound Option

Name	Type	Address	Modify	Delete
host1.example.com	A	WAN1	<input type="radio"/>	<input type="checkbox"/>
host1.example.com	A	WAN2	<input type="radio"/>	<input type="checkbox"/>

### Step 3:

Now, we have 2 entries in the DNS table. Click on **Add new item** again.

## Configure Inbound (CName)

### Select DNS Type

Address  
 Canonical Name  
 Mail eXchanger

Name :

Host :

### Step 4:

This time we are adding the DNS record with the real name for web server.

Select DNS Type with **Canonical Name**.

Name: www.example.com

Host: host1.example.com

## InBound Load Balance

### Load Balance Mode

- Session  
 Weight round robin

### Inbound Option

Name	Type	Address	Modify	Delete
host1.example.com	A	WAN1	<input type="radio"/>	<input type="checkbox"/>
host1.example.com	A	WAN2	<input type="radio"/>	<input type="checkbox"/>
www.example.com	C	host1.example.com	<input type="radio"/>	<input type="checkbox"/>

### Step 5:

The simplest case for the configuration of IN-BOUND ROUTER DNS server is done.

Now the Inbound Load-balancing DNS Server is configured to redirect the Internet requests of [www.example.com](http://www.example.com) to the IP address of either WAN1 or WAN2. But we'll still need to configure the virtual server.

In the IN-BOUND ROUTER configuration: **Advance** → **Virtual Server**

<p style="text-align: center;"><b><u>ALG Options</u></b></p> <p><input type="checkbox"/> IpSec Pass Through (Port 500)</p> <p><input type="checkbox"/> PPTP Pass Through (Port 1723)</p> <p><input type="checkbox"/> VOIP Pass Through</p> <table border="1" style="margin-left: auto; margin-right: auto;"> <thead> <tr> <th></th> <th>From</th> <th>To</th> </tr> </thead> <tbody> <tr> <td>UDP Port</td> <td>1719</td> <td>1719</td> </tr> <tr> <td>TCP Port</td> <td>1720</td> <td>1721</td> </tr> </tbody> </table> <p style="text-align: center;"><b><u>Virtual Server</u></b></p> <table border="1" style="width: 100%; border-collapse: collapse;"> <thead> <tr style="background-color: #00FF00;"> <th>ID</th> <th>Global Port</th> <th>Global IP</th> <th>Local Port</th> <th>Local IP</th> <th>Enable</th> </tr> </thead> <tbody> <tr> <td style="background-color: #00FF00;">1</td> <td>80</td> <td></td> <td>80</td> <td>192.168.1.100</td> <td style="background-color: #00FF00;"><input checked="" type="checkbox"/></td> </tr> <tr> <td style="background-color: #00FF00;">2</td> <td></td> <td></td> <td></td> <td></td> <td style="background-color: #00FF00;"><input type="checkbox"/></td> </tr> </tbody> </table>		From	To	UDP Port	1719	1719	TCP Port	1720	1721	ID	Global Port	Global IP	Local Port	Local IP	Enable	1	80		80	192.168.1.100	<input checked="" type="checkbox"/>	2					<input type="checkbox"/>	<p><b>Step 1:</b></p> <p>The port for <a href="http://www.example.com">www.example.com</a> is 80 and the IP address is: 192.168.1.100.</p> <p>Enter:</p> <p><b>Global Port: 80</b></p> <p><b>Local Port: 80</b></p> <p><b>Local IP: 192.168.1.100</b></p> <p>Select <b>Enable</b>, and then click <b>APPLY</b>.</p>
	From	To																										
UDP Port	1719	1719																										
TCP Port	1720	1721																										
ID	Global Port	Global IP	Local Port	Local IP	Enable																							
1	80		80	192.168.1.100	<input checked="" type="checkbox"/>																							
2					<input type="checkbox"/>																							
<p style="text-align: center;"><b><u>Save &amp; Reset</u></b></p> <p style="text-align: center;">Are you sure to reset Load-Balance Router and save new parameters ?</p> <p style="text-align: center;"><input checked="" type="radio"/> Yes <input type="radio"/> No</p> <p style="text-align: center;"> <input type="button" value="Ok"/> <input type="button" value="Cancel"/> </p>	<p><b>Step 2:</b></p> <p>In order for the Inbound Load Balancing to take effect, we will need to do a system reboot.</p> <p>Select <b>Yes</b> and click on <b>Ok</b>.</p>																											

After the reset sequence is finished, the configured for Inbound Load Balancing is completed.



## A.2 Advanced Load Balancing

We will describe Inbound Load Balancing using “Weighted round robin” algorithm for three Internet servers:

1. Web server, [www.example.com](http://www.example.com), using WAN1 – WAN2, with ratio of 1:2
2. FTP server, [ftp.example.com](ftp://ftp.example.com), using WAN1 –WAN4, with ration of 1:2:3:4
3. Mail server, [mail.example.com](mailto:mail.example.com), using WAN3 & WAN4, with ratio of 3:4

The ratio of 1:2 means that every return of IP address from WAN1, there will be two returned IP addresses from WAN2 for the DNS request.

For the Load Balancing “Weighted round robin” algorithm, you should specify the data rate of each individual WAN ports.

### WAN Control

Select WAN Port WAN1

**WAN Speed**    **WAN1**

Upload(kbits/s) : 1024

Download(kbits/s) : 5120

**Usage Set**    **WAN1**

Procotol	Port	Usage
<input type="checkbox"/> HTTP	<span style="border: 1px solid black; padding: 2px;">80</span>	<span style="border: 1px solid black; padding: 2px;"> </span> %
<input type="checkbox"/> POP3	<span style="border: 1px solid black; padding: 2px;">110</span>	<span style="border: 1px solid black; padding: 2px;"> </span> %
<input type="checkbox"/> SMTP	<span style="border: 1px solid black; padding: 2px;">25</span>	<span style="border: 1px solid black; padding: 2px;"> </span> %
<input type="checkbox"/> FTP	<span style="border: 1px solid black; padding: 2px;">21</span>	<span style="border: 1px solid black; padding: 2px;"> </span> %
<input type="checkbox"/>	<span style="border: 1px solid black; padding: 2px;"> </span>	<span style="border: 1px solid black; padding: 2px;"> </span> %
<input type="checkbox"/>	<span style="border: 1px solid black; padding: 2px;"> </span>	<span style="border: 1px solid black; padding: 2px;"> </span> %
<input type="checkbox"/>	<span style="border: 1px solid black; padding: 2px;"> </span>	<span style="border: 1px solid black; padding: 2px;"> </span> %
<input type="checkbox"/>	<span style="border: 1px solid black; padding: 2px;"> </span>	<span style="border: 1px solid black; padding: 2px;"> </span> %

Ok Cancel

- Define the WAN speed
- 

In **Bandwidth Usage** page, select the WAN port and enter the specific **Download** and **Upload** bandwidth. The bandwidth must be the correct value provided by ISP, or the load balance function might not work properly.

Do the same configuration for the other WAN ports.

## InBound Load Balance

### Load Balance Mode

- Session  
 Weight round robin

WAN1 :	1
WAN2 :	2
WAN3 :	3
WAN4 :	4

### Inbound Option

Name	Type	Address	Modify	Delete
host1.example.com	A	WAN1	<input type="radio"/>	<input type="checkbox"/>
host1.example.com	A	WAN2	<input type="radio"/>	<input type="checkbox"/>
www.example.com	C	host1.example.com	<input type="radio"/>	<input type="checkbox"/>

Add new item

Apply

Cancel

### ■ Define [www.example.com](http://www.example.com) in Inbound Option

In **Load Balance** → **Inbound**, select **Weight round robin** for the inbound load balance mode.

Now you can enter the ratio for each WAN port into their respective fields.

Add the appropriate entries into the Inbound Option table. The entries are similar to the entries for [www.example.com](http://www.example.com) in previous section A.1. We will use host2 for [ftp.example.com](http://ftp.example.com), and here are the results so far.

### Inbound Option

Name	Type	Address	Modify	Delete
host1.example.com	A	WAN1	<input type="radio"/>	<input type="checkbox"/>
host1.example.com	A	WAN2	<input type="radio"/>	<input type="checkbox"/>
www.example.com	C	host1.example.com	<input type="radio"/>	<input type="checkbox"/>
host2.example.com	A	WAN1	<input type="radio"/>	<input type="checkbox"/>
host2.example.com	A	WAN2	<input type="radio"/>	<input type="checkbox"/>
host2.example.com	A	WAN3	<input type="radio"/>	<input type="checkbox"/>
host2.example.com	A	WAN4	<input type="radio"/>	<input type="checkbox"/>
ftp.example.com	C	host2.example.com	<input type="radio"/>	<input type="checkbox"/>

### ■ Define [ftp.example.com](http://ftp.example.com) in Inbound Option

In **Load Balance** → **Inbound** page, this figure is the display for entering: [www.example.com](http://www.example.com) and [ftp.example.com](http://ftp.example.com).

The mail server requires some additional steps.

## Configure Inbound (Addr)

### Select DNS Type

<input checked="" type="radio"/>	Address
<input type="radio"/>	Canonical Name
<input type="radio"/>	Mail eXchanger

Name :

IP Address :

Address :

■ Define [mail.example.com](mailto:mail.example.com) in Inbound Option

#### Step 1:

In **Load Balance** → **Inbound** page, click **Add new item**, select **DNS Type** as **Address**, and configure host name for the Mail server address entry:

Enter:

Name: [mail.example.com](mailto:mail.example.com)

rather than

Name: [host3.example.com](mailto:host3.example.com)

Port: WAN3

## Configure Inbound (Addr)

### Select DNS Type

<input checked="" type="radio"/>	Address
<input type="radio"/>	Canonical Name
<input type="radio"/>	Mail eXchanger

Name :

IP Address :

Address :

#### Step 2:

**Load Balance** → **Inbound** → **Add new item** → **Configure Inbound (Addr)**:

Enter the same domain [mail.example.com](mailto:mail.example.com) to WAN4

## Configure Inbound (CName)

### Select DNS Type

<input type="radio"/>	Address
<input checked="" type="radio"/>	Canonical Name
<input type="radio"/>	Mail eXchanger

Name :

Host :  ▼

#### Step 3:

Load Balance → Inbound →  
Add new item → Configure  
Inbound (CName):

Select **Canonical Name** and  
enter the name as  
[smtp.example.com](http://smtp.example.com), select  
Host with [mail.example.com](http://mail.example.com)

## Configure Inbound (CName)

### Select DNS Type

<input type="radio"/>	Address
<input checked="" type="radio"/>	Canonical Name
<input type="radio"/>	Mail eXchanger

Name :

Host :  ▼

#### Step 4:

Load Balance → Inbound →  
Add new item → Configure  
Inbound (CName):

Similarly, do the previous step  
again for [pop3.example.com](http://pop3.example.com).

## Configure Inbound (MX)

### Select DNS Type

<input type="radio"/>	Address
<input type="radio"/>	Canonical Name
<input checked="" type="radio"/>	Mail eXchanger

Name :

Host :  ▼

#### Step 5:

Load Balance → Inbound →  
Add new item → Configure  
Inbound (MX):

Select Mail eXchange as DNS  
type and enter:  
Name: [example.com](http://example.com)  
Host: [mail.example.com](http://mail.example.com)

# InBound Load Balance

## Load Balance Mode

- Session  
 Weight round robin

WAN1 :	<input type="text" value="1"/>
WAN2 :	<input type="text" value="2"/>
WAN3 :	<input type="text" value="3"/>
WAN4 :	<input type="text" value="4"/>

## Inbound Option

Name	Type	Address	Modify	Delete
host1.example.com	A	WAN1	<input type="radio"/>	<input type="checkbox"/>
host1.example.com	A	WAN2	<input type="radio"/>	<input type="checkbox"/>
www.example.com	C	host1.example.com	<input type="radio"/>	<input type="checkbox"/>
host2.example.com	A	WAN1	<input type="radio"/>	<input type="checkbox"/>
host2.example.com	A	WAN2	<input type="radio"/>	<input type="checkbox"/>
host2.example.com	A	WAN3	<input type="radio"/>	<input type="checkbox"/>
host2.example.com	A	WAN4	<input type="radio"/>	<input type="checkbox"/>
ftp.example.com	C	host2.example.com	<input type="radio"/>	<input type="checkbox"/>
mail.example.com	A	WAN3	<input type="radio"/>	<input type="checkbox"/>
mail.example.com	A	WAN4	<input type="radio"/>	<input type="checkbox"/>
smtp.example.com	C	mail.example.com	<input type="radio"/>	<input type="checkbox"/>
pop3.example.com	C	mail.example.com	<input type="radio"/>	<input type="checkbox"/>
example.com	MX	mail.example.com	<input type="radio"/>	<input type="checkbox"/>

### Step 6:

#### Load Balance → Inbound:

The Mail Server is configured by the last 5 entries of the DNS Name table.



Virtual Server					
ID	Global Port	Global IP	Local Port	Local IP	Enable
1	80		80	192.168.1.100	<input checked="" type="checkbox"/>
2	21		21	192.168.1.200	<input checked="" type="checkbox"/>
3	25		25	192.168.1.2	<input checked="" type="checkbox"/>
4	110		110	192.168.1.2	<input checked="" type="checkbox"/>
5					<input type="checkbox"/>
6					<input type="checkbox"/>
7					<input type="checkbox"/>
8					<input type="checkbox"/>
9					<input type="checkbox"/>
10					<input type="checkbox"/>
11					<input type="checkbox"/>
12					<input type="checkbox"/>

### Step 7:

#### Advance → Virtual Server:

Now we finish the IN-BOUND ROUTER DNS server setting, and we still have to link the WAN IP addresses with the Internal & local LAN servers.

This is done by the **Virtual Server**. Just specify the **Global Port, Local Port, Local IP Address**, and select **Enable**.

The ratio was specified: WAN1, WAN2, WAN3, WAN4 = 1:2:3:4

- www.example.com uses WAN1 and WAN2 with a ratio of 1:2. The IP addresses return to the queries for the Web Server accesses are: WAN1, WAN2, WAN2, WAN1, WAN2, WAN2..., etc.
- ftp.example.com uses WAN1 – WAN4 with a ratio of 1:2:3:4. The IP addresses return to the queries for the Web Server accesses are: WAN1, WAN2, WAN2, WAN3, WAN3, WAN3, WAN4, WAN4, WAN4, WAN4, and the sequence will repeat.
- Mail.example.com uses WAN3 and WAN4 with a ratio of 3:4. The IP addresses return to the queries for the Web Server accesses are: WAN3, WAN3, WAN3, WAN4, WAN4, WAN4, WAN4, and the sequence will repeat.



For multiple Internet servers, if you have Multiple Public Static IPs, you may use the Multiple DMZ to map public static IP address to each server. Or, if you are using Apache or Microsoft Windows Server, then you can use the Virtual Hosting and Virtual Servers function respectively.