

***BUFFALO***<sup>TM</sup>

***NFINITI***<sup>TM</sup>  
Wireless-N

# User Manual

AirStation Wireless-N Nfiniti

Ethernet Converter, Access Point, & Bridge

**WLAE-AG300N**

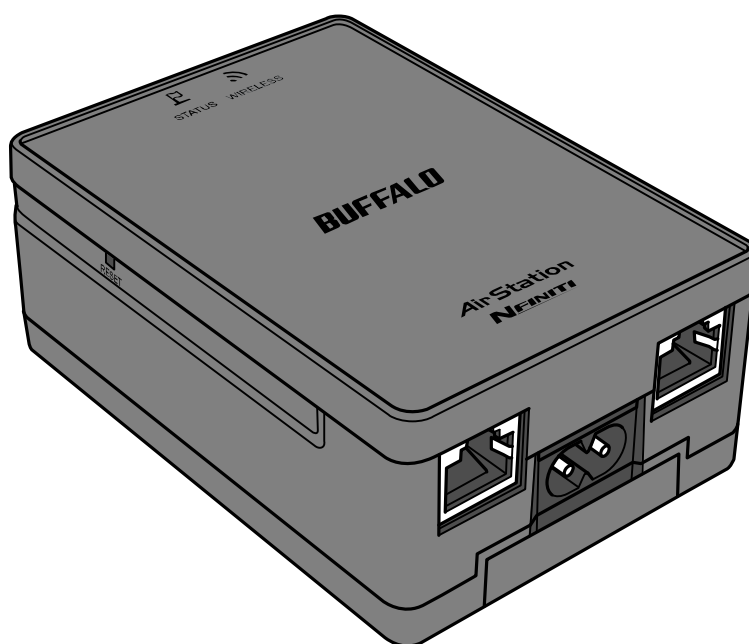

[www.buffalotech.com](http://www.buffalotech.com)

35011293 ver.01

# Contents

<b>Chapter 1 Product Overview .....</b>	<b>5</b>
Features .....	5
AirNavigator CD Requirements .....	6
300 Mbps High Speed Mode .....	6
Package Contents .....	6
Hardware Overview .....	7
Front View .....	7
Rear View .....	8
Bottom .....	10
<b>Chapter 2 Placing Your AirStation .....</b>	<b>11</b>
Horizontal Placement .....	11
Wall-Mounting .....	11
<b>Chapter 3 Installation .....</b>	<b>13</b>
Automatic Setup .....	13
Manual Setup .....	13
Access Point mode .....	13
Using AirStation As An Ethernet Converter or A Repeater .....	15
<b>Chapter 4 Configuration .....</b>	<b>20</b>
Accessing the Web-based Configuration Interface .....	20
Configuration Interface Menus .....	23
Setup .....	25
LAN Config .....	27
LAN .....	27
Route .....	28
Wireless Config .....	29

WPS.....	29
AOSS .....	30
11n/a/g/b .....	32
Advanced .....	36
WMM.....	37
MAC Filter .....	39
Multicast Control .....	40
WDS.....	41
Admin Config.....	43
Name .....	43
Password .....	44
Time/Date .....	45
NTP .....	46
ECO .....	47
Access .....	48
Log .....	49
Save/Restore .....	50
Initialize/Restart .....	51
Update .....	52
Diagnostic .....	53
System Info.....	53
Logs .....	55
Packet Info.....	56
Client Monitor.....	57
Ping.....	58

## **Chapter 5 Connect to a Wireless Network ..... 59**

---

Automatic Secure Setup (AOSS/WPS).....	59
Windows 7/Vista (Client Manager V) .....	60
Windows XP (Client Manager 3).....	61
To connect two WLAE-AG300Ns or other wireless devices which support AOSS/WPS (AOSS/WPS) .....	61
Other Devices (e.g. Game Console).....	62

Manual Setup .....	62
Windows 7 (WLAN AutoConfig) .....	62
Windows Vista (WLAN AutoConfig) .....	63
Windows XP (Wireless Zero Configuration).....	66
Connecting 2 WLAE-AG300Ns (Manual Setup) .....	67
<b>Chapter 6 Trouble Shooting .....</b>	<b>68</b>
Cannot connect to the Internet (wired connection). .....	68
Cannot access the web-based configuration interface. ....	68
Cannot connect to the network wirelessly. ....	68
You forgot AirStation's SSID, Encryption Key, or Password....	69
The link speed is slower than 300 Mbps (Maximum link speed is only 130Mbps).....	69
Other Tips.....	70
<b>Appendix A Specifications .....</b>	<b>72</b>
<b>Appendix B Default Configuration Settings.....</b>	<b>74</b>
<b>Appendix C Ethernet Converter Manager .....</b>	<b>78</b>
Ethernet Converter Manager Overview.....	78
Opening and Closing Ethernet Converter Manager.....	78
Select LAN Adapter screen .....	79
Select Ethernet Converter .....	80
Main Screen .....	81
Modify IP Address Screen.....	83
Connection Settings .....	84
<b>Appendix D TCP/IP Settings in Windows .....</b>	<b>85</b>

**Appendix E Restoring the Default Configuration..... 88**

**Appendix F Regulatory Compliance Information ..... 89**

**Appendix G Environmental Information..... 95**

**Appendix H GPL Information ..... 96**

**Appendix I Warranty Information ..... 97**

**Appendix J Contact Information ..... 98**

# Chapter 1

## Product Overview

### Features

---

#### **Supports IEEE802.11n and IEEE802.11a/b/g**

With support for current Wireless-N, Wireless-A, Wireless-G, and Wireless-B standards, the AirStation can transfer data to and from all standard 2.4 GHz and 5 GHz wireless clients.

This device does not support simultaneous communication on the 2.4 GHz and 5 GHz bands.

#### **Supports AOSS and WPS**

Both AOSS (AirStation One-touch Secure System) and WPS (Wi-Fi Protected Setup) are supported. These automatic connection standards make connection with compatible wireless devices easier.

#### **Security**

The AirStation supports the following security standards:

- AOSS
- WPS
- WPA-PSK (TKIP/AES)
- WPA2-PSK (TKIP/AES)
- WPA/WPA2 mixed PSK
- WEP (128/64 bit)
- Privacy Separator
- MAC filtering
- Stealth SSID

#### **Automatic Channel Selection**

Monitors wireless interference and automatically assigns the clearest, best channel.

#### **Roaming**

You can use multiple AirStations to cover a large area. Wireless clients can automatically switch AirStations for the best signal.

#### **Initialization**

To restore settings back to the factory defaults, hold down the Reset button on the side of the unit.

#### **Browser Based Administration**

This unit can be easily configured from a password-protected web page through a browser on your computer.

## AirNavigator CD Requirements

---

The AirStation wireless access point works with most wired and wireless devices. However, the automatic installation program on the CD requires a connected Windows 7, Vista, or XP computer to run. If you use the AirStation with a different operating system, you will have to configure your network settings manually from a browser window.

## 300 Mbps High Speed Mode

---

300 Mbps is the maximum link speed when using Wireless-N mode with dual 40 MHz channels. Usable sustained data rates will be substantially slower.

## Package Contents

---

The following items are included in your AirStation package. If any of the items are missing, please contact your vendor.

- WLAE-AG300N ..... 1
- AC power cable..... 1
- Screws for wall-mounting..... 2
- LAN cable ..... 1
- Air Navigator CD..... 1
- Quick Setup Guide..... 1

## Hardware Overview

---

### Front View

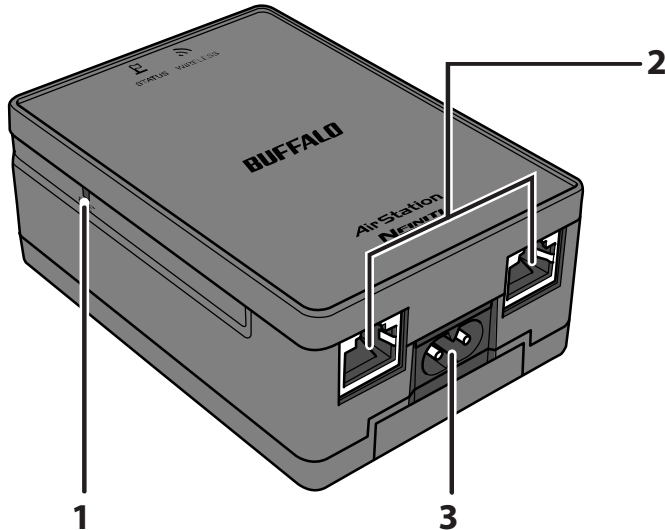

#### **1 Reset Button**

To restore the AirStation back to factory default settings, press and hold this button until the red status LED flashes (about 3 seconds).

#### **2 LAN Ports**

Connect your computer, hub, or other Ethernet devices to these ports. This switching hub supports 10 Mbps and 100 Mbps connections.

#### **3 Power Connector**

Connect the power cable here.



## Rear View

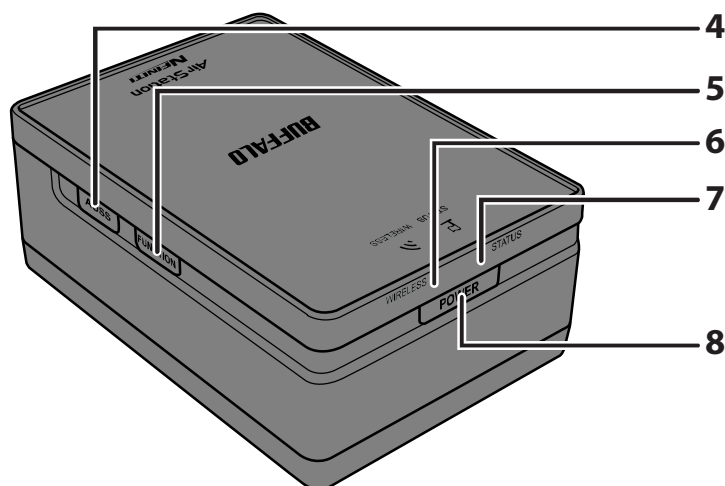

### 4 AOSS/WPS Button

To initiate AOSS/WPS, hold down this button until the wireless LED flashes (about 1 second). Then, push or click the AOSS or WPS button on your wireless client device to complete the connection. Both devices must be powered on for this to work.

### 5 Function Button

Hold down this button until the wireless and status LEDs flash amber (about 3 seconds) to move to the transmission speed measurement mode.

After measuring the speed, the wireless LED illuminates in the following color depending on transmission quality.

Green:	Good
Amber:	Normal
Red:	Bad

### 6 Wireless LED

Shows wireless LAN status.

On (Green) :	5 GHz wireless
On (Amber) :	2.4 GHz wireless
Blinking :	AOSS/WPS error
On (Red) :	Wireless is not working.
Off :	Power is off.

## 7 Status LED

Shows AirStation status.

On (Green) : WDS is enabled as Master, or WDS is enabled as a Slave connected to the Master.

2 blinks (Green) : WDS is enabled as a Slave, not connected to the Master.

1 blink (Red) \*1 : RAM error.

2 blinks (Red) \*1 : Flash ROM error.

3 blinks (Red) \*1 : Wired Ethernet LAN error.

4 blinks (Red) \*1 : Wireless LAN error.

Continuously Updating firmware, saving settings, or initializing settings.

blinking (Red) \*2 :

\*1 Turn off AirStation first, wait for a few seconds, then turn it back on.

\*2 If the status LED keeps blinking, do not turn off the AirStation nor unplug its power cable.

## 8 Power Button

Press the power button to turn on the AirStation. To turn it off, hold the power button down for 5 seconds.

## Bottom

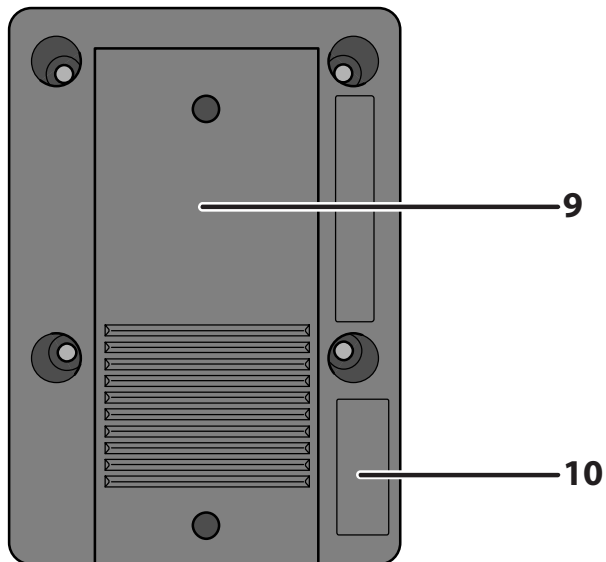

**9 Wall Mount Plate** Slide this plate out to wall mount. Attach to the wall with the 2 screws (included). Then, slide the AirStation onto the plate.

**10 Factory Default Settings** This sticker shows the AirStation's SSID, default encryption key, and WPS PIN code. By default, encryption is disabled for AirStations sold in Asia Pacific.

# Chapter 2

## Placing Your AirStation

### Horizontal Placement

---

Place the unit as shown.

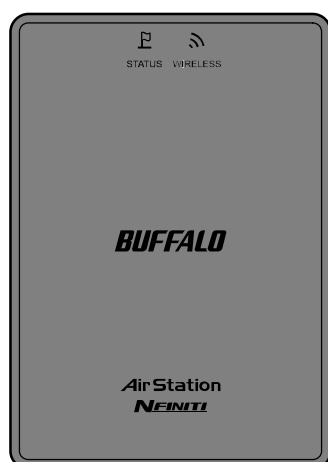

### Wall-Mounting

---

- 1 Slide the plate out from the bottom of the AirStation.

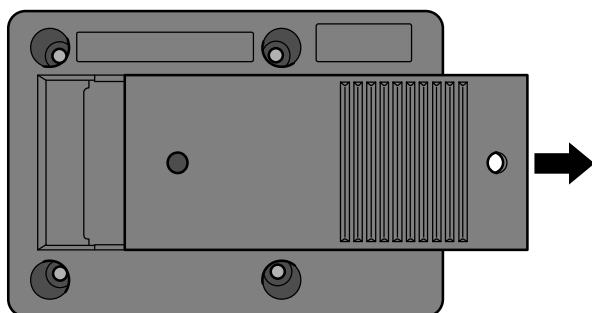

- 2 Secure the plate to the wall with the two screws in your package.

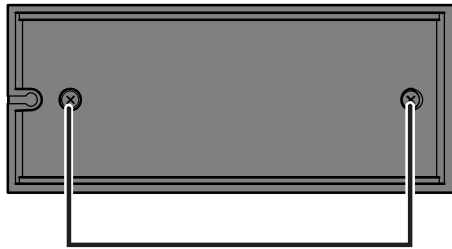

7.5 cm  
(~2.95 inches)

- 3 Slide the AirStation onto the wall-mounting plate.

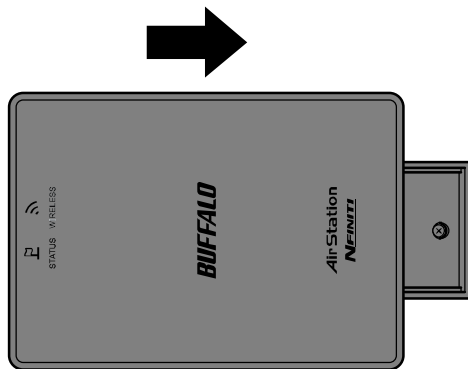

# Chapter 3

## Installation

### Automatic Setup

---

The AirNavigator CD can step you through installing your AirStation. Insert it into your Windows 7, Vista, or Windows XP PC and follow the instructions on the screen. If your computer uses a different operating system, use manual setup instead.

### Manual Setup

---

#### Access Point mode

To use the AirStation as an access point, configure as below.

- 1** Make sure that you can connect to the Internet without the AirStation, then turn the computer off.
- 2** Connect one end of the LAN cable to the router that you are currently using, and connect the other end to the LAN port of the AirStation.

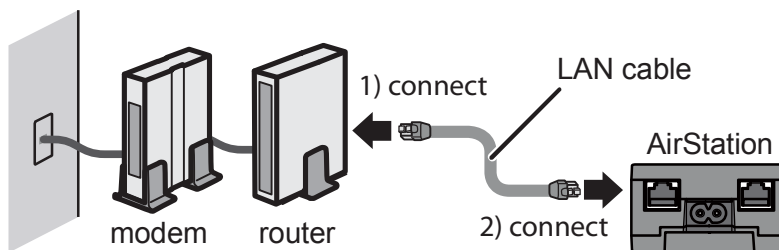

- 3** Connect the AirStation to your computer with another LAN cable.

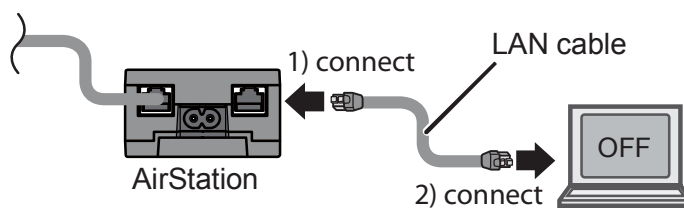

- 4** Connect the power cable to the AirStation, then push the power button to turn it on. Wait 60 seconds, then power on your computer.

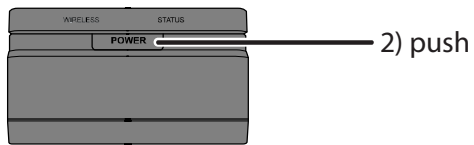
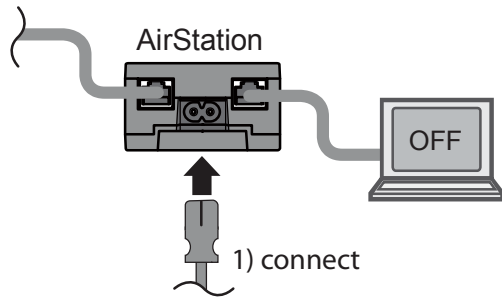

- 5** After the computer has booted, the LEDs on the AirStation should be in the following condition:
- |          |                         |
|----------|-------------------------|
| Wireless | glowing green or amber. |
| Status   | glowing green.          |
- 6** Launch a web browser. If the home page is displayed, setup is complete.

You've completed initial setup of your AirStation. Refer to Chapter 4 for advanced settings.

## Using AirStation As An Ethernet Converter or A Repeater

To use the AirStation as an Ethernet converter or a repeater, follow the directions below.

### Using as an Ethernet Converter:

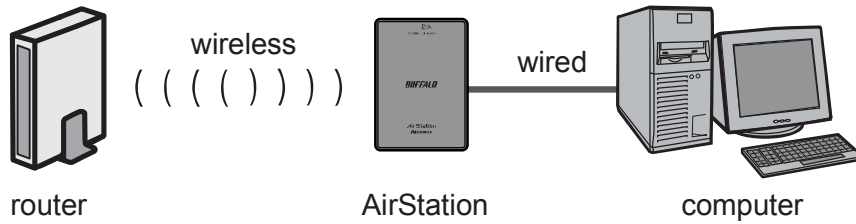

### Using as a repeater:



In this section, manual configuration is described. However, you can also use AOSS/WPS to configure it. Refer to Chapter 5 for details.

- 1 Set your computer's IP address settings as follows (Appendix D).

IP Address	192.168.11.80
Subnet mask	255.255.255.0
Default gateway	192.168.11.1
Preferred DNS server	192.168.11.1
Alternate DNS server	blank

- 2 Shut down your computer.



- 3** Connect the AirStation and your computer with a LAN cable.

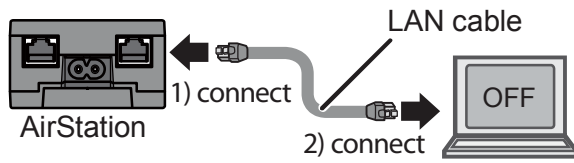

- 4** Connect the power cable to the AirStation, then push the power button to turn it on. Wait 60 seconds, then power on your computer.

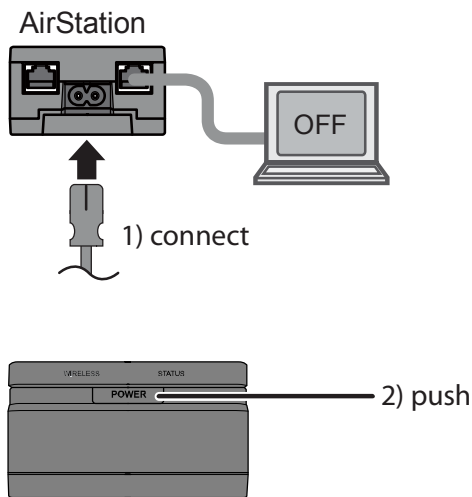

- 5** After the computer has booted, the LEDs on the AirStation should be in the following condition:

Wireless - glowing green or amber.  
Status - glowing green.

- 6** Launch a web browser.

7

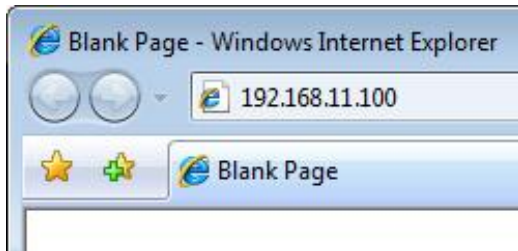

Enter the LAN IP address of the AirStation in the address field, then press the [Enter] key.

- Notes:
- The default IP address of the AirStation is 192.168.11.100.
  - If you previously used the AirNavigator CD in the package to set up the AirStation, then its IP address may be set as [Automatically obtain from DHCP server].
  - If you have changed the IP address of the AirStation, enter that IP address.

8



When this screen appears, enter [root] (in lower case) for the user name and the password that you set during initial setup. Click [OK].

- Notes:
- By default, the password is blank (not set).
  - If you forget your password, hold down the reset button (page 7) to initialize all settings. The password will then be blank. Note that all other settings will also revert to their default values.

9

Click [Wireless Config] > [WDS].



- 10** If the device you connect supports WDS such as WHR-G300N, WHR-HP-G300N and WZR-HP-G300NH, select [Slave] from [Specify Master/Slave] menu and click [Search].  
If the device you connect doesn't support WDS, select [Slave(EC)] from [Specify Master/Slave] menu and click [Search].



**Slave:**

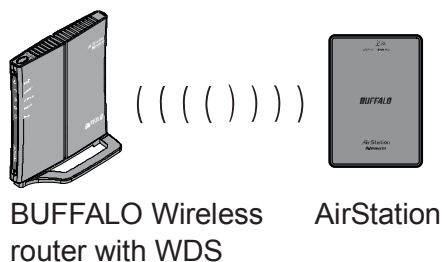

**Slave(EC):**

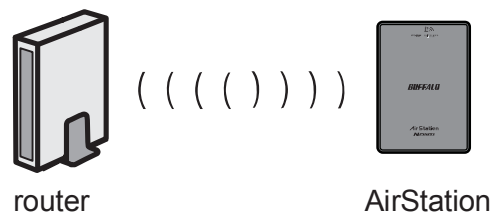

- 11** Once the list of the access points is displayed, select the access point you are going to connect to, then click [Select].  
If the access point you are going to connect to is not displayed, click [Search again].

Select AirStation (Master) to connect to.

Select	SSID	Wireless ch	Signal	Encryption	Wirm
<input checked="" type="radio"/>	manual_A	48	Excellent	Yes	r
<input type="radio"/>	WAP-G	1	Week	Yes	n/
<input type="radio"/>	001D738C0054_3	3	Week	Yes	n/

Select    Search again    Cancel

- 12** Enter the encryption settings and password (“key”) for the access point you are connecting to, then click [Apply].

WDS <input checked="" type="checkbox"/> Use	
Specify Master/Slave	Slave(EC) ▾
SSID	manual_A <input type="button" value="Search"/>
Wireless authentication	WPA2-PSK ▾
Encryption for wireless	AES ▾
WPA-PSK (Pre-shared key)	●●●●●●●●●●
<input type="button" value="Apply"/>	

- 13** The AirStation’s LEDs should be as follows:

Wireless - glowing green or amber  
Status - glowing green

Note: If the status LED flashes twice, the information that you entered for the the encryption settings may be wrong. Reconfigure the settings correctly.

- 14** Change your computer’s IP address settings back to their former values.

ex) IP Address                      Obtain an IP address automatically  
DNS server                        Obtain DNS server address automatically

Note: If using the AirStation as a repeater, unplug the LAN cable from your computer. You’re now connected to the AirStation wirelessly.

- 15** Launch a web browser. If your home page is displayed, setup is complete.

# Chapter 4

## Configuration

The web-based configuration tool lets you change AirStation settings. Don't change these settings unless you know what you're doing.

### Accessing the Web-based Configuration Interface

To configure the AirStation's advanced settings manually, log in to the web-based configuration interface as shown below.

- 1 Insert the AirNavigator CD into your computer. The setup wizard will automatically launch.  
Note: If the Setup Wizard does not launch, open the CD and double-click [ASSetWiz.exe] to launch manually.

- 2  Click [View WEB setting screen].

- 3  The wizard will search for available AirStations.

4

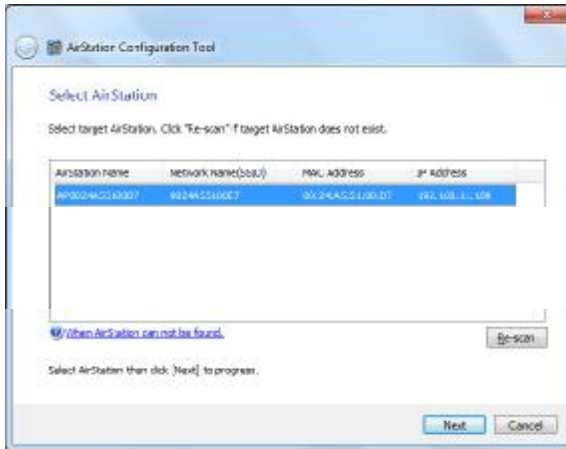

Highlight an AirStation to configure and click [Next].

5

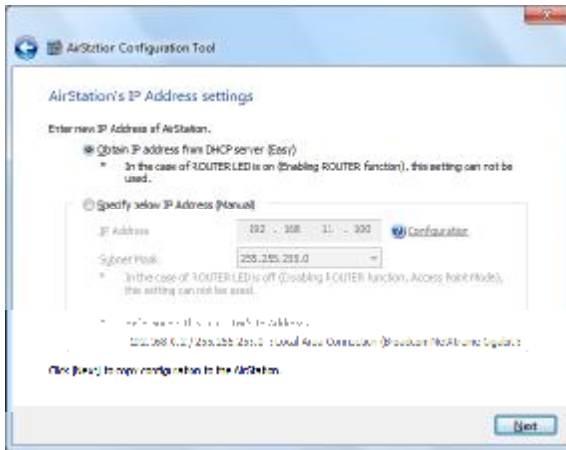

Check [Obtain IP address from DHCP server] to have DHCP obtain an IP address automatically, or you may enter IP address settings manually. Click [Next].

Note: This screen may not be displayed depending on your computer's IP address settings.

6



Enter [root] for the user name and the password that you set during initial setup. Click [OK].

- Notes:
- By default, the password is blank (not set).
  - If you forget your password, hold down the reset button (page 7) to initialize all settings. The password will then be blank. Note that all other settings will also revert to their default values.

7

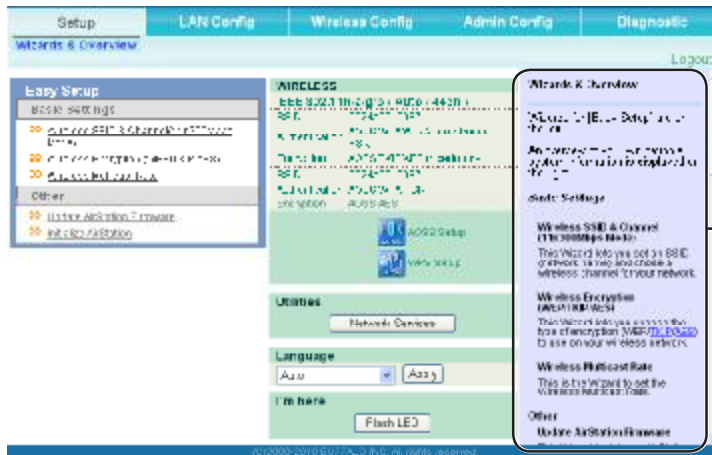

This is the configuration interface, where most AirStation settings can be configured.

Help is always displayed on the right side of each screen. Refer to the Help screens for more information on using the configuration interface.

## Configuration Interface Menus

The following settings may be changed from the configuration interface. Please refer to the pages listed at right for explanations of each item.

Main screen	Descriptions	Page
<b>LAN Config</b>		
LAN	LAN side port configuration.	Page 27
Route	Configure the AirStation's IP communication route.	Page 28
<b>Wireless Config</b>		
WPS	WPS settings and status.	Page 29
AOSS	AOSS (AirStation One-touch Secure System) settings and status.	Page 30
11n/a/g/b	Configure basic wireless settings.	Page 32
Advanced	Configure advanced wireless settings.	Page 36
WMM	Set priorities for Wireless Multimedia Extensions (Wi-Fi Multimedia).	Page 37
MAC Filter	Limit access to specific devices.	Page 39
Multicast Control	Configure limits on sending unnecessary multicast packets to the wireless LAN port.	Page 40
WDS	Configure communication among AirStation	Page 41
<b>Admin Config</b>		
Name	Configure the AirStation's name.	Page 43
Password	Configure the AirStation's login password for access to the configuration interface.	Page 44
Time/Date	Configure the AirStation's internal clock.	Page 45
NTP	Configure the AirStation to synchronize with an NTP server to automatically set the AirStation's internal clock.	Page 46
ECO	Configure the AirStation's ECO Mode.	Page 47
Access	Configure access restrictions to the AirStation's configuration screens.	Page 48
Log	Configure a syslog server to manage the AirStation's logs.	Page 49
Save/Restore	Save or restore the AirStation's configuration from a configuration file.	Page 50
Initialize/Restart	Initialize the AirStation or reboot it.	Page 51
Update	Update the AirStation's firmware.	Page 52
<b>Diagnostic</b>		
System Info	View current system information for the AirStation.	Page 53
Logs	Check the AirStation's logs.	Page 55



Packet Info	View all packets transferred by the AirStation.	Page 56
Client Monitor	View all devices currently connected to the AirStation.	Page 57
Ping	Test the AirStation's connection to other devices on the network.	Page 58
Logout		
Click this to log out of the AirStation's configuration screens.		

# Setup

This is the home page of the configuration interface. You can verify settings and the status of the AirStation here.

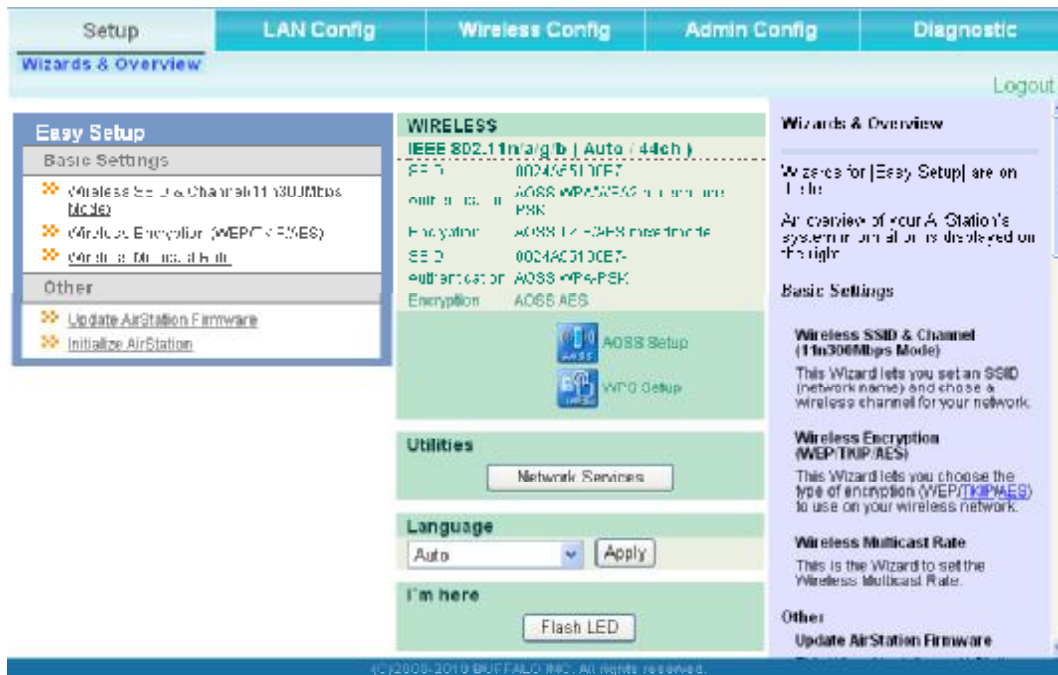

Parameter	Meaning
LAN Config	Displays the configuration screen for the LAN ports.
Wireless Config	Click this button to display the configuration screen for wireless settings.
Admin Config	Click this button to display the configuration screen for administration settings.
Diagnostic	Click this button to display the status of the AirStation.
Easy Setup	Enables you to easily configure the AirStation's network settings automatically.
WIRELESS	Displays the current wireless settings.
AOSS Setup	Click this button to display the AOSS configuration screen.

<b>Parameter</b>	<b>Meaning</b>
WPS Setup	Click this button to display the WPS configuration screen.
[Network Services]	Displays the list of the network devices for which information is provided from the network on the LAN-side.
Language	Enables you to select the language you use.
[Flash LED]	Clicking this to flash Status LED of the AirStation you are currently setting for 30 seconds.
Logout	Log out from the configuration screen of the AirStation. If the AirStation does not communicate for 5 minutes, it will log out automatically.

---

# LAN Config

## LAN

Configure LAN-side port.

The screenshot shows a web interface for LAN configuration. At the top, there are tabs for 'Setup', 'LAN Config', 'Wireless Config', 'Admin Config', and 'Diagnostic'. Below the tabs, there are sub-tabs for 'LAN' and 'Route'. A 'Logout' link is visible in the top right. The main content area is divided into two columns. The left column contains the 'LAN Side IP Address' section with radio buttons for 'Acquire IP Address Automatically' and 'Manual Setup'. The 'Manual Setup' option is selected. Below this are input fields for 'IP Address' (192.168.11.100) and 'Subnet Mask' (255.255.255.0). Underneath is an 'Advanced Setting' section with fields for 'Default Gateway', 'DNS Server Address' (Primary and Secondary), and an 'Apply' button. The right column contains a 'LAN Side Ethernet Settings' section with explanatory text and links for 'LAN Side IP Address', 'Acquire an IP Address Automatically', and 'Manual Setup'. A copyright notice '(C)2000-2010 BUFFALO INC. All rights reserved.' is at the bottom of the interface.

Parameter	Meaning
LAN Side IP Address	By default, the LAN side IP address is 192.168.11.100 with subnet mask 255.255.255.0. You may change it here.
Default Gateway	Set the default gateway IP address.
DNS Server Address	Set the DNS server IP address.

## Route

Configure the AirStation's IP communication route.

Parameter	Meaning
Destination Address	Adds a destination IP address and subnet mask to a routing table.
Gateway	Adds a gateway address to a routing table.
Metric	The metric is the maximum number of router hops a packet may take on the way to its destination address. Values between 1 and 15 may be entered. The default value is 15.
Routing Information	Manual entries will appear here after being added.

## Wireless Config

### WPS

WPS Status and Settings.

Setup | LAN Config | **Wireless Config** | Admin Config | Diagnostic

WPS | AOSS | 11n/a/g/b | Advanced | WMM | MAC Filter | Multicast Control | WDS

Logout

WPS  enable  
 External Registrar Request is rejected in AOSS mode.

Apply

AirStation PIN 87174885

Enrollee PIN

**WPS Security Information**

WPS status	configured(AOSS)	
11n/a	SSID	UU24A5510UB7
	Security	WPAWPA2 mixedmode - PSK TKIP/AES mixedmode
	Encryption key	4m4nkw34n4t4u
11n/g/b	SSID	0024A55100B7
	Security	WPAWPA2 mixedmode - PSK TKIP/AES mixedmode
	Encryption key	4m4nkw34n4t4u

**WPS(WiFi Protected Setup)**

**WPS**  
 Configuring WPS  
 WPS is WiFi Protected Setup which corresponds to Windows Connect Now-NET (WCN-NET). WPS is also known as the Wi-Fi Simple Configuration Protocol. WPS function can safely and easily distribute wireless security information from an access point (Airstation) to the WPS clients. The WPS device which registers wireless security information is called Registrar. The Airstation has an internal Registrar built-in it, but can also use an External Registrar. The WPS device which receives the wireless security information from the Registrar is called Enrollee.

The default is Enable.

**Warning**  
 When the wireless radio is

(C)2000-2010 BUFFALO INC. All rights reserved.

Parameter	Meaning
WPS	Enable to use WPS automatic configuration.
External Registrar	Enable to accept the external configure requests from other WPS devices. Note: External configure requests will not be accepted if AOSS is in use.
AirStation PIN	Displays the PIN code of the AirStation. Clicking [Generate PIN] will generate a new PIN code. This code can be entered into other wireless devices that support WPS.
Enrollee PIN	Enter the PIN code for the other wireless device and click [OK].
WPS status	Displays [configured] if all available wireless bands are configured. Displays [unconfigured] if at least one wireless band is unconfigured.

# AOSS

## AOSS Status and Settings.

The screenshot shows the AOSS (All Station One-Touch Secure System) configuration page. The top navigation bar includes Setup, LAN Config, Wireless Config, Admin Config, and Diagnostic. The AOSS Settings section includes:

- Encryption Type of Exclusive SSID for WEP: Stop
- Encryption level expansion function: Enabled
- Dedicated WEP SSID isolation: Disabled
- Use the WEP configuration priority:  Enable
- AOSS Function in the Authentication:  Enable

The Current Encryption Information section shows:

- Encryption Type: WEP256**
  - SSID: 00249500B7
  - Encryption Key: 4m4...02495
  - Encryption Key: 00000000000000000000000000000000
  - SSID: 00249500B7
  - Encryption Key: 4m4...02495
- Encryption Type: WEP128**
  - SSID: 00200F000700FFA0700FFFA070000000000
  - Encryption Key: 00F0140089000000000000000000000000 (Sending Key)
  - Encryption Key: 003872F038F10082603021EF
  - Encryption Key: 00120F1525716050040000000000000000
  - Encryption Key: 4E7E71040000000000000000000000000000
- Encryption Type: WEP104**
  - SSID: 00D024021A000040001004E90240D0
  - Encryption Key: 000000000000000000000000000000000000 (Sending Key)
  - Encryption Key: 000000000000000000000000000000000000
  - Encryption Key: 000000000000000000000000000000000000
  - Encryption Key: 000000000000000000000000000000000000

The AOSS Client Information section shows a table with columns: Client number, MAC Address, Encryption type, Wireless, and CONNECTION Setting.

Client number	MAC Address	Encryption type	Wireless	CONNECTION Setting
01-00-00-00-00-00	00-10-00-00-00-00	WEP256	WLAN	WLAN

The AOSS Ethernet Converter Information section includes links for Client Information, MAC Address, and Encryption type.

On the right side, the Start AOSS button is described as follows:

**Start AOSS button**  
Click this button to start AOSS. The AOSS button on top of the main page has the same as this button. Refer to [Getting Started](#) for more details.

The Disable AOSS button is described as follows:

**Disable AOSS button**  
This button appears when AOSS is enabled. Click this button to disable AOSS. When this button is clicked, the connection to wireless LAN will be terminated. Refer to [Getting Started](#) for more details. When you click this button, the default value of the Current Encryption Information will be restored. Wireless LAN and Wireless Security are enabled in Advanced Settings when AOSS is disabled.

**How to use AOSS**  
How to use AOSS (WLAN)  
From the main panel of the All Station One-Touch Secure System, click on the AOSS button.  
Press the AOSS button on the main panel of the All Station One-Touch Secure System. The AOSS button and the AOSS alert will change to secure information. If you click the AOSS button, the AOSS alert will appear automatically and send an e-mail to the administrator.

**Note:**



- Do not use AOSS buttons on the All Station One-Touch Secure System (WLAN) in the All Station One-Touch Secure System (WLAN) if you are using the All Station One-Touch Secure System (WLAN) in the All Station One-Touch Secure System (WLAN) in the All Station One-Touch Secure System (WLAN).
- If the 24-bit encryption mode is used, the AOSS alert will be displayed through the AOSS alert.
- The default AOSS alert is set to "All Station One-Touch Secure System (WLAN) is disabled by pressing the AOSS button. Please refer to the All Station One-Touch Secure System (WLAN) for more details."
- The AOSS alert is not displayed when the AOSS alert is disabled in the All Station One-Touch Secure System (WLAN).
- The wireless security is not supported when the AOSS alert is disabled in the All Station One-Touch Secure System (WLAN).

In the following cases, the setting of wireless security is not supported in AOSS when:

- The wireless security is not supported in the All Station One-Touch Secure System (WLAN).
- The wireless security is not supported in the All Station One-Touch Secure System (WLAN).
- The wireless security is not supported in the All Station One-Touch Secure System (WLAN).

In the following cases, the setting of wireless security is not supported in AOSS when:

- The wireless security is not supported in the All Station One-Touch Secure System (WLAN).
- The wireless security is not supported in the All Station One-Touch Secure System (WLAN).
- The wireless security is not supported in the All Station One-Touch Secure System (WLAN).

Parameter	Meaning
	Initiates AOSS automatic wireless configuration. Click this, then press or click the AOSS button on your AOSS-compatible wireless client. Repeat for additional AOSS clients.
	Click this button to disconnect AOSS connections. Note: If AOSS connections are disconnected, the SSID and encryption keys will be restored to their most recent settings before using AOSS.
Encryption Type of Exclusive SSID for WEP	You may allow a separate SSID specifically for WEP connections. If [disabled] is selected, then clients will not be able to connect with WEP.
Encryption level expansion function	Expands security method from TKIP to WPA/WPA2-PSK-mixed mode.
Dedicated WEP SSID isolation	Set a separate SSID and network segment specifically for WEP connections. Devices connected with WEP will not be able to communicate with devices connected using AES/TKIP. All connected devices will be able to communicate with the internet.
Allow WEP for Game Console Only	When enabled, the AirStation allows wireless devices to connect with 64 or 128 bit WEP.
AOSS Button on the AirStation Unit	Uncheck to disable the physical AOSS button on the AirStation.
Current Encryption Information (AOSS connections only)	Displays the encryption type, SSID, an encryption key configured by AOSS.
[Random]	Click to enter random values for SSID, encryption key, and other settings.
[KEY base]	Click to return the SSID, encryption key, and other wireless settings to the values on the case sticker.
[Reset]	Click to return the SSID, encryption key, and other wireless settings to their previous values.
AOSS Client Information (Only displayed if there are AOSS connections)	Displays AOSS clients connected to the AirStation and information of the devices which are wirelessly communicated.
AOSS Ethernet Converter Information (Only displayed if there are AOSS connections)	Displays information about ethernet converters connected to the AirStation via AOSS.



## 11n/a/g/b

The screen to configure a basic wireless settings.

Parameter	Meaning
Wireless	Determines whether to allow wireless communication. If this is unchecked, then no wireless connections will be allowed.
Wireless Channel	Sets a channel (a range of frequencies) used for wireless connections. With Auto Channel selected, the AirStation will automatically use the best available channel.
300 Mbps Mode	300 Mbps mode uses twice the normal frequency range, 40 MHz instead of 20 MHz. In uncongested areas this can increase performance. To use 300 Mbps mode, set the Bandwidth to 40 MHz and choose an Extension Channel. Note: If using Auto Channel for the wireless channel, then the extension channel is set automatically.

<b>Parameter</b>	<b>Meaning</b>
Broadcast SSID	If [Allow] is checked, then the AirStation will respond to SSID searches from wireless devices by broadcasting its SSID. If [Allow] is unchecked, then the AirStation ignores SSID searches from wireless devices.
[Allow multiple SSIDs] [Use Single SSID]	Clicking [Allow multiple SSIDs] will enable Multi Security, allowing the use of multiple SSIDs, each with different wireless security settings. Clicking [Use Single SSID] will disable the Multi Security function. The AirStation will then allow one SSID and one type of wireless security. Note: When using Multi Security, you need to enable at least one of the following: SSID1, SSID2, or SSID3.
SSID1	Multi Security SSID1 can use WPA-PSK-TKIP or WPA/WPA2-Mixed for wireless security.
SSID2	Multi Security SSID2 can use WPA-PSK-AES for wireless security.
SSID3	Multi Security SSID3 can use WEP for wireless security.
Separate feature	When [Separate] is enabled, wireless devices connected to the AirStation can communicate only with the Internet side, not with each other.
SSID	Set SSID using 1-32 alphanumeric characters.
Wireless authentication	Specifies an authentication method used when connecting to a wireless device.

Parameter	Meaning
Wireless encryption	<p>You may use any of the following types of encryption:</p> <p><b>No encryption</b> Data is transmitted without encryption. Avoid this option since any communication may be intercepted. [No encryption] can be selected only when [No authentication] is selected for Wireless authentication.</p> <p><b>WEP</b> WEP is a common encryption method supported by most devices. Use an encryption key to communicate with a wireless device. WEP can only be selected when [No authentication] is selected for Wireless authentication.</p> <p><b>TKIP</b> TKIP is an encryption method which is more secure than WEP, but slower. Use an pre-shared-key to communicate with a wireless device. TKIP can be selected only when WPA-PSK or WPA2-PSK is selected for Wireless authentication.</p> <p><b>AES</b> AES is more secure than TKIP, and faster. Use a pre-shared-key to communicate with a wireless device. AES can be selected only when WPA-PSK or WPA2-PSK is selected for Wireless authentication.</p> <p><b>TKIP/AES mixed mode</b> TKIP/AES mixed mode allows both TKIP and AES authentication and communication. TKIP/AES mixed mode can be selected only when WPA/WPA2 mixed mode - PSK is selected for Wireless authentication.</p>
WPA-PSK (Pre-Shared Key)	<p>A pre-shared key or passphrase is the password for your wireless connections. There are two different formats for a pre-shared key. Use 8 to 63 alphanumeric characters (case-sensitive) for a character (ASCII) passphrase, or use 64 digits using 0 to 9 and a to f (not case-sensitive) for a hexadecimal passphrase.</p>
Rekey interval	<p>Set the update interval for the encryption key between 0 and 1440 (minutes).</p>

<b>Parameter</b>	<b>Meaning</b>
Set up WEP encryption key	A WEP encryption key (passphrase) may have any of four different formats. A character (ASCII) passphrase may use either 5 or 13 alphanumeric characters (case-sensitive). A hexadecimal passphrase may use either 10 or 26 digits using 0 to 9 and a to f (not case-sensitive).

## Advanced

Configure advanced wireless settings.

Parameter	Meaning
Multicast Rate	Set the communication speed of multi-cast packets.
DTIM Period	Set the beacon responding interval (1 -255) for which the AirStation responds to a wireless device. This setting is effective only when power management is enabled for the wireless device.
Privacy Separator	If enabled, the Privacy Separator blocks communication between wireless devices connected to the AirStation. Wireless devices will be able to connect to the Internet but not with each other. Devices that are connected to the AirStation with wired connections will still be able to connect to wireless devices normally.
TPC	This feature will avoid causing interference by outputting unnecessarily strong radio in the vicinity. Check this to decrease radio output of 802.11a about 3 dB.

## WMM

Set priorities for specific communications.

Setup	LAN Config	Wireless Config	Admin Config	Diagnostic
WPS	AOSS	11n/a/g/b	Advanced	WMM
				MAC Filter
				Multicast Control
				WDS
Logout				

### WMM-EDCA Parameters

Priority	Parameter	For AP	For STA
AC_BK(Low)	CWmin:	15	15
	CWmax:	1023	1023
	AIFS:	7	7
	TXOP Limit:	0	0
	Admission Control:	----	Disable
AC_BE(Normal)	CWmin:	15	15
	CWmax:	63	1023
	AIFS:	3	3
	TXOP Limit:	0	0
	Admission Control:	----	Disable
AC_VI(High)	CWmin:	7	7
	CWmax:	15	15
	AIFS:	1	2
	TXOP Limit:	94	94
	Admission Control:	----	Disable
AC_VO(Highest)	CWmin:	3	3
	CWmax:	7	7
	AIFS:	1	2
	TXOP Limit:	47	47
	Admission Control:	----	Disable

### WMM Settings (11n/a/11n/g/b)

Prioritized AirStation communication for specific transactions. This settings provides some real time communication, which can help improve the quality of VOIP or other streaming protocols.

---

### WMM-EDCA Parameters

It is usually not necessary to change this value.

**Priority**  
The priority is ranked (Highest)8 : (High)4 : (Normal)2 : (Low)1 for each packet.

**Parameter**

**CWmin, CWmax**  
The maximum and minimum value for the contention window. The contention window is used to control the frame collision avoidance system in IEEE802.11. Values that can be inputted: 1-32767.

**AIFS**  
Interval of the sending frame. The unit defines a time-slot (similar to the window value of CWmin, CWmax). Lower values define a higher priority as the back-off algorithm starts earlier. Values that can be inputted: 1-15.

**TXOP Limit**  
The time for the queue to obtain send priority. The minimum value is 32ms. Large values can send more frames at a time. However, latency may increase. Only one frame is transferred at the time when the TXOP Limit is 0.

(C)2000-2010 BUFFALO INC. All rights reserved.

Parameter	Meaning
WMM-EDCA Parameters	<p>You don't usually need to change these settings. Using the default settings is recommended.</p> <p><b>Priority</b> The following priorities may be applied to individual transmission packets: (Highest) 8, (High) 4, (Normal) 2, and (Low) 1. From the queue, these packets are processed in order of priority.</p> <p><b>CWmin, CWmax</b> The maximum and minimum value of the contention window. The contention window is used in the frame collision avoidance structure performed in IEEE802.11, and generally, the smaller the value in the window, the higher the probability that the queue obtains the right to send.</p> <p><b>AIFSN</b> The interval to send frames. The unit of the AIFSN is a slot, just as the window defined by CWmin and CWmax is. The smaller the interval of sending frames, the faster the algorithm can restart. As a result, the priority of the queue is higher.</p> <p><b>TXOP Limit</b> The period of time that the queue can use after obtaining the right to send. The unit is 32 ms. The longer this time, the more frames can be sent per right to send. However, the queue may interfere with other packet transmissions. If TXOP Limit is set to 0 (zero), only one frame can be sent per right to send.</p> <p><b>Admission Control</b> Restricts new frames from interfering with a previous queue. New packets are prioritized lower until a queue of them is collected. As the new queue accumulates more packets, its priority increases.</p>

## MAC Filter

Restrict access to specific wireless devices.



Parameter	Meaning
Enforce MAC Filtering	Enable to restrict wireless connections to devices with registered MAC addresses.
Registration List	Displays the MAC addresses of registered devices which are permitted to connect wirelessly.
[Edit Registration List]	Click to add a wireless device to the list of permitted devices.
MAC Addresses to be Registered	Enter a MAC address of a wireless device to permit to connect to the AirStation. Click [Register] to add that MAC address to the list.
List of all clients that are associated with this AirStation	Display the list of all MAC addresses of wireless devices connected to the AirStation.



## Multicast Control

Configure restrictions on unnecessary multicast packets sent to the wireless LAN port.

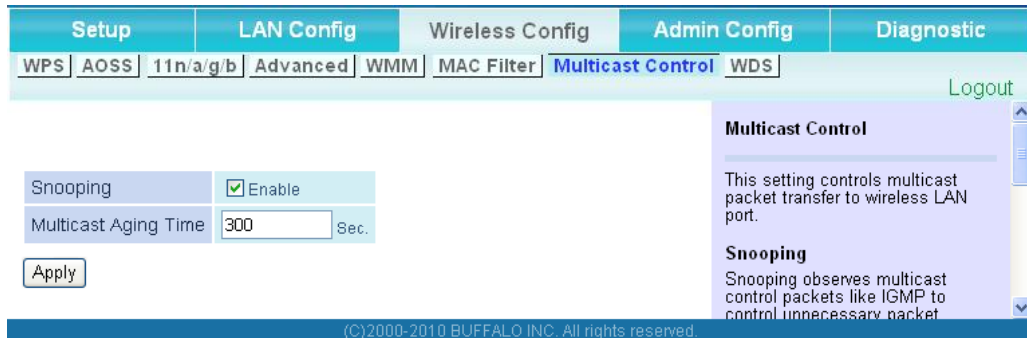

Parameter	Meaning
Snooping	If enabled, snooping supervises multicast administrative packets such as IGMP and restricts unnecessary multicast transfers to wired or wireless ports.
Multicast Aging Time	Set the time to hold the data from multicast snooping in the range of 1 to 3600 (seconds). Enter a value bigger than the IGMP/MLD query interval.

## WDS

WDS bridging allows communication between AirStations.

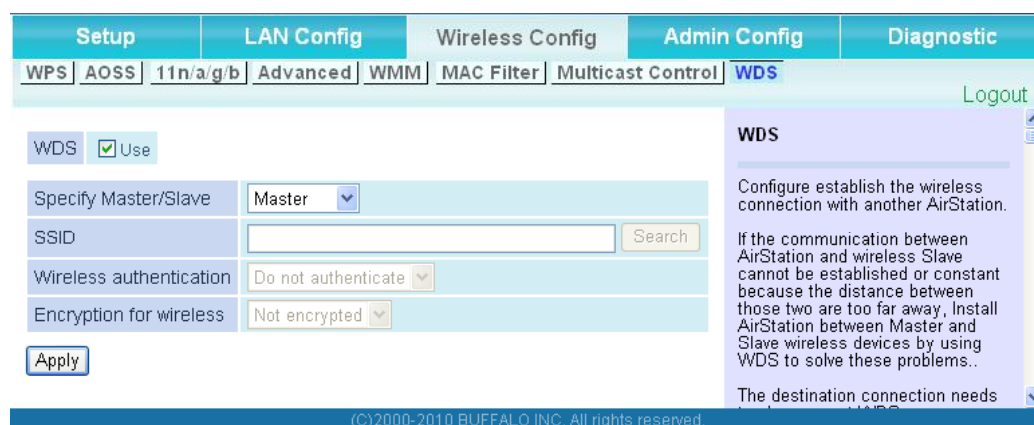

Parameter	Meaning
WDS	Check to use WDS bridging.
Specify Master/Slave	Define this AirStation's role in a WDS bridge. <ul style="list-style-type: none"> <li><b>Master</b> Set AirStation as a master. Listen to the Slave or a device set as a slave to connect.</li> <li><b>Slave</b> Set AirStation as a slave. This can be connected with the AirStation which is set as a master by using WDS feature only if the Master AirStation supports WDS.</li> <li><b>Slave (EC)</b> Set AirStation as a slave. This uses Ethernet Converter to connect with the AirStation which is set as a master, so it can be connected even though Master AirStation does not support WDS.</li> <li><b>Auto</b> Switch [Master] and [Slave] mode automatically depending on the network environment. Note: It does not switched to [Slave (EC)] mode automatically.</li> </ul>

Parameter	Meaning
SSID	Configure the Master Airstation's SSID.
[Search]	Click to search for other AirStations' SSIDs.
Wireless authentication	Configure authentication method for the master AirStation
Encryption for wireless	Choose encryption type for the master AirStation.
WPA-PSK (Pre Shared Key)	Set the master AirStation's Encryption key.

- Notes:
- Up to 2 Slave AirStations (Slave 1) can be connected to per Master AirStation.
  - Up to 2 levels of Slave AirStation (Slave 1 and Slave2) can be connected per Master AirStation.

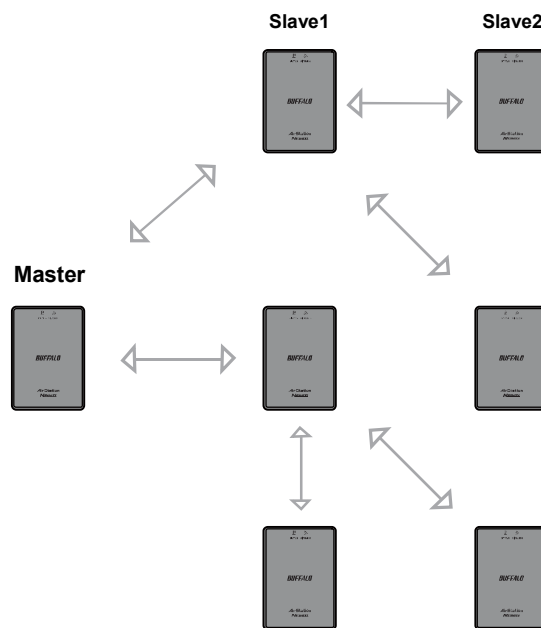

## Admin Config

---

### Name

Configure basic AirStation settings.

The screenshot shows the 'Admin Config' section of the configuration interface. The 'Name' tab is selected, showing options for 'Name', 'Password', 'Time/Date', 'NTP', 'ECO', 'Access', 'Log', and 'Save/Restore'. The 'AirStation Name' field contains the text 'AP0024A55100B7'. Below it, the 'List Network Services' checkbox is checked and labeled 'Enable'. An 'Apply' button is visible. A help tooltip for 'AirStation Name' is open, stating: 'This can be used to assign a specific descriptive name for the AirStation. The AirStation name may be up to 64 alphanumeric characters in'. A footer at the bottom of the interface reads '(C)2000-2010 BUFFALO INC. All rights reserved.'

Parameter	Meaning
AirStation Name	Enter a name for the AirStation. Names may include up to 64 alphanumeric characters and hyphens (-).
List Network Services	Enable or disable this item to display the computers and devices on your network with their supported services.

## Password

Configure the password to log in to the AirStation's configuration screen.

The screenshot shows the configuration interface with the following elements:

- Navigation tabs: Setup, LAN Config, Wireless Config, Admin Config, Diagnostic.
- Sub-tabs under Admin Config: Name, Password, Time/Date, NTP, ECO, Access, Log, Save/Restore.
- Buttons: Initialize/Restart, Update, Logout.
- Administrator Name: root (fixed)
- Administrator Password: Two masked input fields with a (Confirm) label.
- Apply button.
- Help panel:
  - AirStation Administrator Password**
  - Administrator name**: This is the user name used to log into the AirStation's configuration screens. It cannot be changed from 'root'.
  - Administrator password**
- Footer: (C)2000-2010 BUFFALO INC. All rights reserved.

Parameter	Meaning
Administrator Name	The Administrator name is used to log in to the AirStation's configuration interface. This name is fixed as [root].
Administrator Password	The password is required to log in. It may contain up to 8 alphanumeric characters and underscores (_).

## Time/Date

Configure the AirStation's internal clock.

**An NTP time server is configured**

Local Date: 2010 Year 1 Month 1 Day

Local Time: 0 Hour 13 Minute 40 Seconds

Time Zone: (GMT-06:00) Central Standard Time: CST

Apply Refresh Get Current Time from your PC

**Time/Date**  
Set the AirStation's internal clock. Set the internal clock manually.

**Note:**  
The AirStation's internal clock is reset to its default setting whenever power is lost because it doesn't have a battery. However, the AirStation may be configured to adjust its clock automatically even when rebooted by connecting it to a NTP server.

(C)2000-2010 BUFFALO INC. All rights reserved.

Parameter	Meaning
Local Date	You may manually set the date of the AirStation's internal clock.
Local Time	You may manually set the time of the AirStation's internal clock.
Time Zone	Specify the time zone (offset of Greenwich Mean Time) of the AirStation's internal clock.

## NTP

Configure an NTP server to automatically synchronise the AirStation's internal clock.

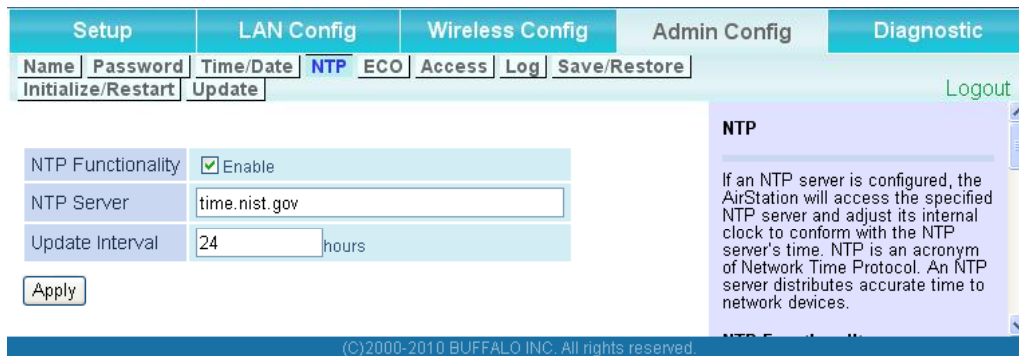

The screenshot shows the NTP configuration interface. At the top, there are navigation tabs: Setup, LAN Config, Wireless Config, Admin Config, and Diagnostic. Under the Admin Config tab, there are sub-tabs: Name, Password, Time/Date, NTP, ECO, Access, Log, and Save/Restore. The NTP sub-tab is selected, displaying a configuration form. The form includes a checkbox for 'NTP Functionality' which is checked and labeled 'Enable'. Below it is a text input field for 'NTP Server' containing 'time.nist.gov'. Further down is a numeric input field for 'Update Interval' set to '24', followed by the unit 'hours'. An 'Apply' button is located at the bottom left of the form. To the right of the form is a help box titled 'NTP' with the following text: 'If an NTP server is configured, the AirStation will access the specified NTP server and adjust its internal clock to conform with the NTP server's time. NTP is an acronym of Network Time Protocol. An NTP server distributes accurate time to network devices.' At the bottom of the page, a footer reads '(C)2000-2010 BUFFALO INC. All rights reserved.'

Parameter	Meaning
NTP Functionality	Enable to use an NTP server. The default is Enabled.
NTP Server	Enter the name of the NTP server as a host name, host name with domain name, or IP address. Up to 255 alphanumeric characters, hyphens (-), and underscores (_) may be used. The default is [time.nist.gov].
Update Interval	How often will the AirStation check the NTP server for the correct time? Intervals of 1 - 24 hours may be set. The default is 24 hours.

## ECO

Configure Eco mode from this screen.

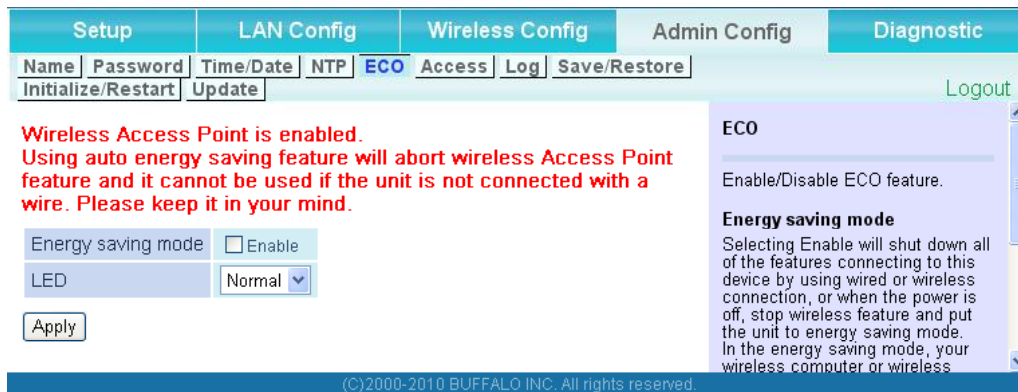

Parameter	Meaning
Energy saving mode	Enabling the energy setting mode will shut down the AirStation whenever all connected wired Ethernet devices are shut down. When a connected device resumes communication with the AirStation's Ethernet port, the AirStation will power on normally again. To use the energy saving mode, you must have at least one wired Ethernet device connected or the unit will shut down.
LED	LED is lit when Normal Mode is selected. Turn it off when OFF is selected.



## Access

Restrict access to the AirStation's settings screens.

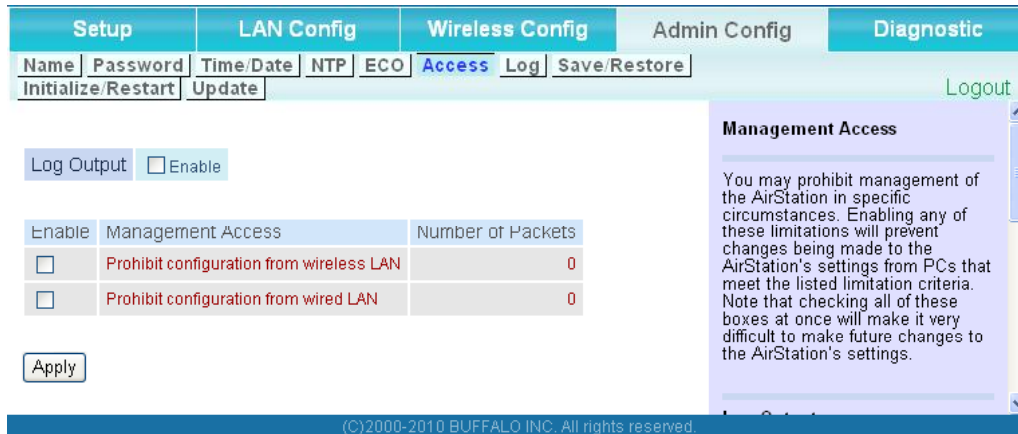

Parameter	Meaning
Log Output	Enabling outputs a log of changes to access settings.
Prohibit configuration from wireless LAN	If enabled, prevents access to settings screens from wirelessly connected devices (only wired devices may configure).
Prohibit configuration from wired LAN	If enabled, prevents access to settings screens from wired devices (only wirelessly connected devices may configure).

## Log

Transfer the AirStation's logs to a syslog server.

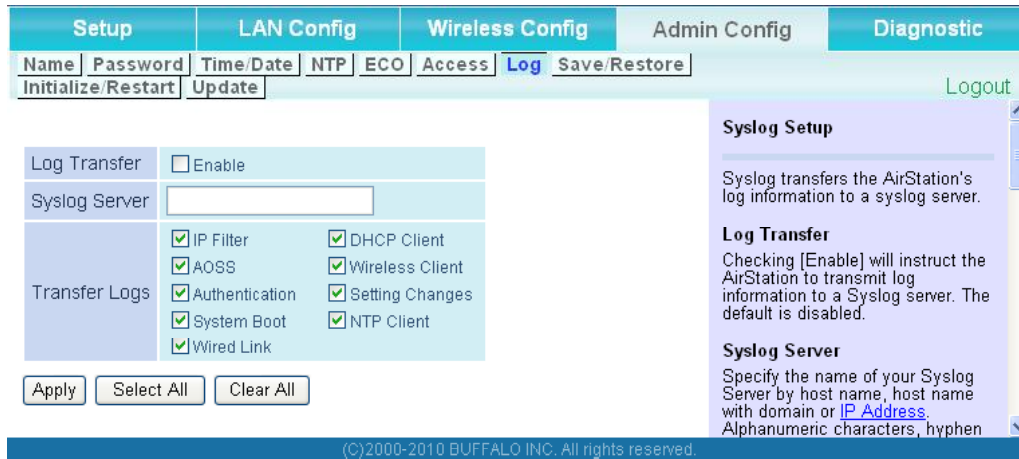

Parameter	Meaning
Log Transfer	Enable to send logs to a syslog server.
Syslog Server	Identify the syslog server by host name, host name with domain name, or IP address. You may enter up to 255 alphanumeric characters, hyphens (-), and underscores (_).
Transfer Logs	Choose which logs will be transferred to the syslog server.

## Save/Restore

Save AirStation settings as a file, and restore from them later.

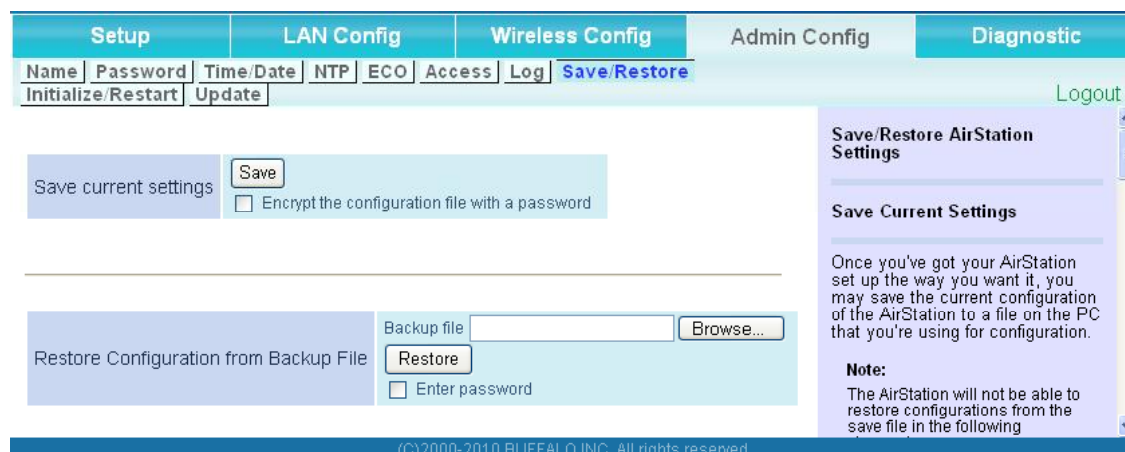

Parameter	Meaning
Save current settings	Clicking [Save] will save the current configuration of the AirStation to a file. If the [Encrypt the configuration file with a password] option is checked, then the configuration file will be password protected with the current Administrator Password.
Restore Configuration from Backup File	Restore the configuration of the AirStation from a saved configuration file by clicking the [Browse...] button, navigating to the configuration file, and then clicking Restore. If the configuration file was password protected, then put a check next to [Enter password], enter the password, and click [Open].

## Initialize/Restart

Initialize or restart the AirStation.

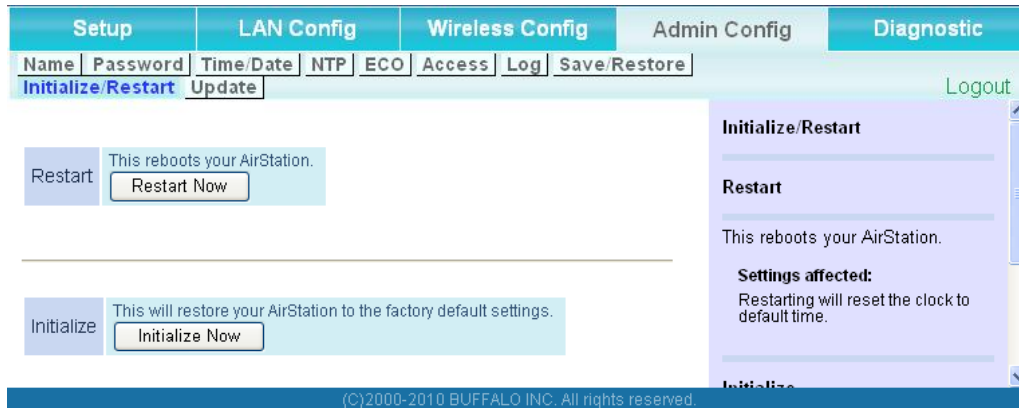

Parameter	Meaning
Restart	Click [Restart Now] to restart the AirStation.
Initialize	Click [Initialize Now] to initialize and restart the AirStation.

## Update

Update the AirStation's firmware.

The screenshot shows the 'Firmware Update' page in the AirStation web interface. At the top, there are navigation tabs: Setup, LAN Config, Wireless Config, Admin Config, and Diagnostic. Below the tabs is a menu with options: Name, Password, Time/Date, NTP, ECO, Access, Log, Save/Restore, Initialize/Restart, and Update. A 'Logout' link is visible in the top right. The main content area is divided into two columns. The left column contains a table with the following information:

Firmware Version	WLAE-AG300N Ver.1.80
Update Method	<input checked="" type="radio"/> Specify Local File <input type="radio"/> Auto Update Online
Firmware File Name	<input type="text"/> <input type="button" value="Browse..."/>

Below the table is an 'Update Firmware' button. Underneath, there is a note: '\*Get updated firmware files from our website:' followed by a link to 'Download Service'. The right column contains a 'Firmware Update' section with the following text:

**Firmware Update**  
Update the AirStation's firmware.

**Current Firmware**  
Displays the firmware version of the AirStation.

**Update Method**  
|

**Specify Local File**  
Update the firmware with a file stored on the local PC.

**Automatic Update (On Line Version Up)**

At the bottom of the page, there is a copyright notice: '(C)2000-2010 BUFFALO INC. All rights reserved.'

Parameter	Meaning
Firmware Version	Displays the current firmware version of the AirStation.
Update method	<p><b>Specify Local File</b> Updates the firmware stored on your computer.</p> <p><b>Auto Update Online</b> Automatically updates the latest firmware that is available online.</p>
Firmware File Name	Click [Browse...] to specify a firmware file, then click [Update Firmware]. You don't need to specify the firmware location if selecting [Auto Update Online].

# Diagnostic

## System Info

View system information for the AirStation.

Setup	LAN Config	Wireless Config	Admin Config	Diagnostic
<b>System Info</b>	Logs	Packet Info	Client Monitor	Ping
				Logout

<b>Model</b>	WLAE-AG300N Ver.1.80 (R1.57/B1.00)	
<b>AirStation Name</b>	AP0024A55100B7	
<b>LAN</b>	<b>Method of Acquiring IP Address</b>	Manual Setting
	<b>IP Address</b>	192.168.11.100
	<b>Subnet Mask</b>	255.255.255.0
	<b>Default Gateway</b>	Not Set
	<b>DNS (Primary)</b>	Not Set
	<b>DNS (Secondary)</b>	Not Set
	<b>MTU Value</b>	1500
	<b>MAC Address</b>	00:24:A5:51:00:B7
<b>Wireless</b>	<b>Wireless Status</b>	Enabled
	<b>SSID</b>	0024A55100B7
	<b>Authentication</b>	WPAWPA2 mixedmode - PSK
	<b>Encryption</b>	TKIP/AES mixedmode
	<b>Broadcast SSID</b>	Enable
	<b>Privacy Separator</b>	Disable
	<b>Wireless Channel</b>	802.11n/a/g/b : 44 (Auto)
	<b>300Mbps Mode</b>	40 MHz (Extension Channel : 48)
	<b>MAC Address</b>	00:24:A5:51:00:B7
<b>WDS</b>	<b>Connection Status</b>	Activated as master
	<b>Status</b>	-

**System Information**

Display the AirStation's main settings.

**Model**  
Displays the model name and firmware version of the AirStation.

**AirStation Name**  
Displays the AirStation's host name.

**LAN**  
AirStation LAN information.

**IP Address**  
IP address acquisition.

**Connection Status**  
Display the current LAN port status under DHCP configuration.

**Operation**  
DHCP configuration. If DHCP is in use, the following commands can be executed.

- [Release] : Releases the IP address assigned by the DHCP Server.
- [Renew] : Renews the IP address from the DHCP Server.

**IP Address**  
The IP address assigned to the AirStation.

**Subnet Mask**  
The Subnet Mask assigned to the AirStation.

(C)2000-2010 BUFFALO INC. All rights reserved.

---

<b>Parameter</b>	<b>Meaning</b>
Model	Displays the product name of the AirStation and the firmware version.
AirStation Name	Displays the AirStation Name.
LAN	Displays the information about the LAN port.
Wireless	Displays the wireless status.
WDS	Displays the information about WDS port.

---

## Logs

The AirStation's logs are recorded here.

The screenshot shows the 'Logs' configuration page in the AirStation web interface. The page is divided into several sections:

- Navigation Tabs:** Setup, LAN Config, Wireless Config, Admin Config, Diagnostic.
- Sub-Tabs:** System Info, Logs (selected), Packet Info, Client Monitor, Ping.
- Display log info:** A list of log types with checkboxes:
  - IP Filter
  - AOSS
  - Authentication
  - System Boot
  - Wired Link
  - DHCP Client
  - Wireless Client
  - Setting Changes
  - NTP Client
- Buttons:** Display, Select All, Clear All.
- Logs Section:** Save to file logfile.log., Delete.
- Log Table:**

Date Time	Type	Log Content
2010/01/01 00:00:22	DHCP	sending DHCP_RELEASE for 192.168.11.8 to 192.168.11.1
2010/01/01 00:00:19	WIRED	et1: enet unit:1 phy:0 is up...
2010/01/01 00:00:18	NTP	probe_count=0 hostname=ntp.jst.mfeed.ad.jp cycle_time=86400
2010/01/01 00:00:18	NTP	start ntpclient
2010/01/01 00:00:05	BOOT	WLAE-AG300N
- Right Panel:** Logout, Logs section with description: 'Display log information recorded in the AirStation. The oldest information is overwritten by new logs.' and 'Display log info' section with a list of log types to be selected:
  - IP Filter
  - DHCP Client
  - AOSS
  - Wireless Client (Start/stop and client connection)
  - Authentication
  - Setting Changes
  - System Boot
  - NTP Client
  - Wired Link

Parameter	Meaning
Display log info	Choose the types of logs to display.
Logs	Displays the log information recorded in the AirStation.



## Packet Info

View packet transfer information.

The screenshot shows a web interface with a top navigation bar containing 'Setup', 'LAN Config', 'Wireless Config', 'Admin Config', and 'Diagnostic'. Below this is a sub-menu with 'System Info', 'Logs', 'Packet Info' (highlighted), 'Client Monitor', and 'Ping'. A 'Logout' link is visible in the top right. The main content area features a table with the following data:

Interface	Sent		Received	
	Normal	Errors	Normal	Errors
Wired LAN	1421	0	1413	0
Wireless LAN	0	0	0	0
WDS Bridge	0	0	0	0

Below the table is a 'Refresh' button. To the right, a 'Packet Traffic Information' panel explains that the table shows total packets sent and received by the AirStation, including errors. It also notes that the '[Refresh] button' renews the displayed information.

(C)2000-2010 BUFFALO INC. All rights reserved.

Parameter	Meaning
Sent	Displays the number of packets sent to the LAN side of the Ethernet, and the LAN side of the wireless connection.
Received	Displays the number of packets received from the LAN side of the Ethernet, and the LAN side of the wireless connection.

## Client Monitor

This screen shows devices that are connected to the AirStation.

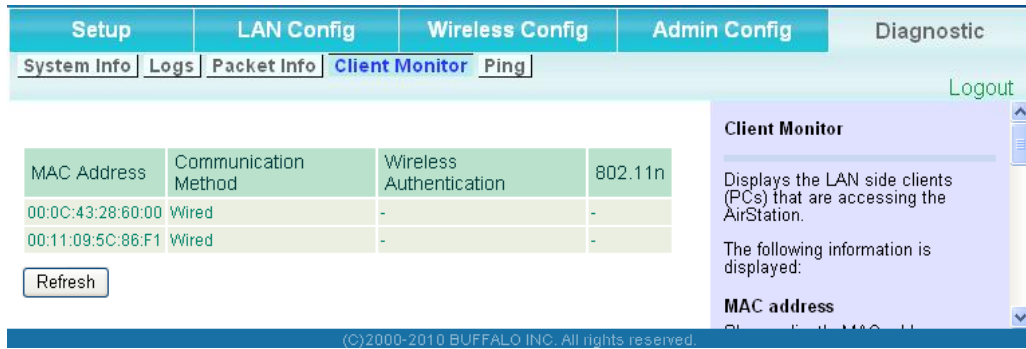

Parameter	Meaning
Client Monitor	Displays information ( MAC address, communication method, wireless authentication and 802.11n) for devices that are connected to the AirStation.

## Ping

A Ping test checks whether the AirStation can communicate with a specific network device.

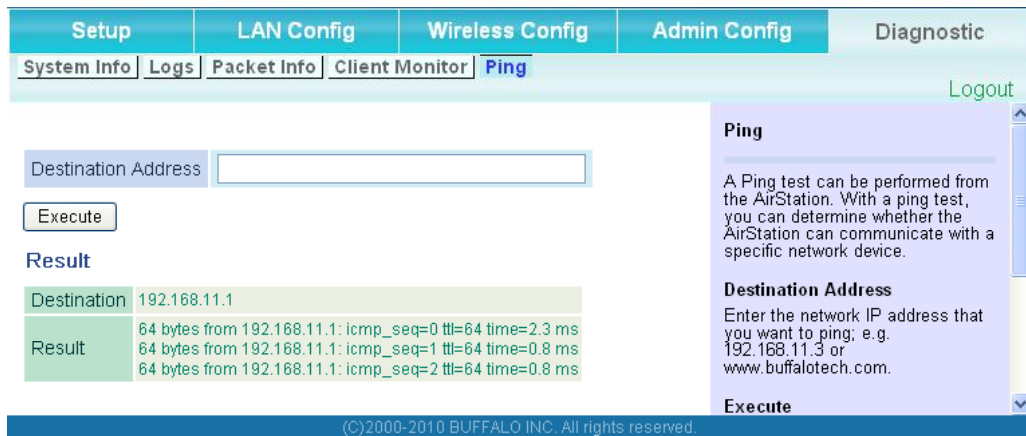

Parameter	Meaning
Destination Address	Enter an IP address or a host name of the device for which you try to verify the connection, and click [Execute]. The result will be displayed in the [Result] field.

# Chapter 5

## Connect to a Wireless Network

### Automatic Secure Setup (AOSS/WPS)

---

AOSS and WPS are systems which let you automatically configure wireless LAN settings. Just pressing the buttons will connect wireless devices and complete security settings. Easily connect to wireless devices, computers, or game machines which support AOSS or WPS.



AOSS (AirStation One-Touch Secure System) was developed by Buffalo Technology. WPS was created by the Wi-Fi Alliance.

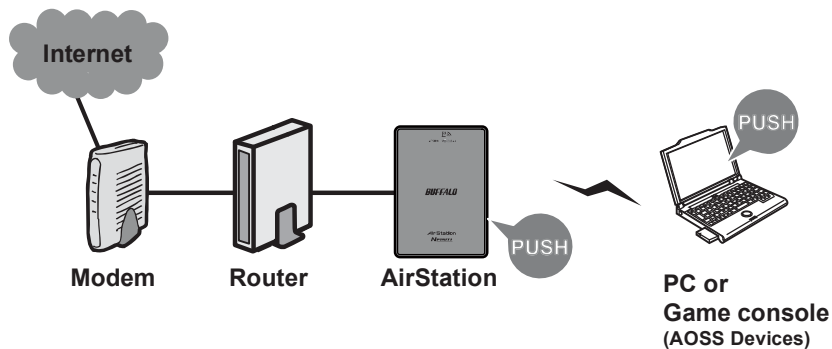

- Before using AOSS/WPS to connect to a Buffalo wireless client, install Client Manager software from the included AirNavigator CD. Consult your wireless client's documentation for more information.
- Buffalo's Client Manager software can be used with the wireless LAN devices built into your computer. However, it is not guaranteed to work with all wireless LAN devices available. Some wireless clients may require manual setup.

## Windows 7/Vista (Client Manager V)

If you are using Windows 7 or Windows Vista, use the included Client Manager V software to connect wirelessly with AOSS/WPS.

1 Click the  icon in the system tray.

2  Click [Create Profile].

3 When the message "A program needs your permission to continue" appears, click [Yes] or [Continue].

4  Click the [WPS AOSS] button.

Follow any instructions displayed on the screen. When the wireless LED on the front of the AirStation stops flashing and glows steadily, the connection is complete.

## Windows XP (Client Manager 3)

If you are using Windows XP, use Client Manager 3 to connect wirelessly with AOSS/WPS.

1 Right click on the  icon displayed in the system tray, and select [Profile].



Click [WPS AOSS] button.

Follow any instructions displayed on the screen. When the wireless LED on the front of the AirStation stops flashing and glows steadily, the connection is complete.

## To connect two WLAE-AG300Ns or other wireless devices which support AOSS/WPS (AOSS/WPS)

To connect WLAE-AG300N each other or other wireless devices which support AOSS/WPS, press and hold AOSS or WPS button on each device for a several seconds. After pressing button for a while connection settings are automatically completed.

## Other Devices (e.g. Game Console)

If you are using a game machine which supports AOSS or WPS, refer to that device's manual to initiate AOSS/WPS. When instructed, hold down the AOSS button on the AirStation for 1 seconds.

When the wireless LED stops flashing and begins to glow steadily, the connection is complete.

## Manual Setup

---

You can also connect to the AirStation without installing Client Manager V or Client Manager 3 by using the utility built-in to Windows. The procedure varies depending on which version of Windows you are using.

### Windows 7 (WLAN AutoConfig)

With Windows 7, use WLAN AutoConfig to connect to the AirStation.

- 1 Click on the network icon  in the system tray.

- 2  Select the target AirStation's name and click [Connect]. If you will be connecting to this device in the future, checking [Connect automatically] is recommended.

**3**



Enter the encryption key and click [OK].

## Windows Vista (WLAN AutoConfig)

With Windows Vista, use the WLAN AutoConfig to connect to the AirStation.

**1**

Right click on the wireless network icon  in the system tray.

**2**

Click [Connect to a network].

**3**

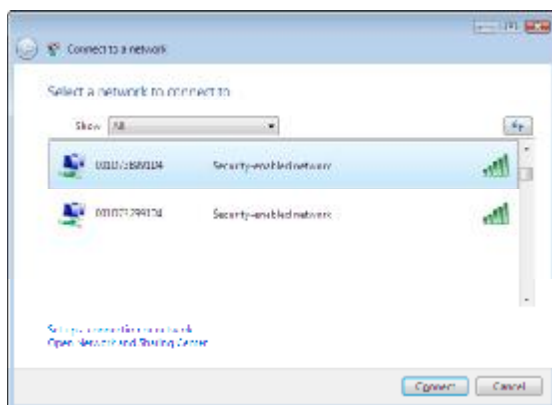

When the screen at left is displayed, select the network to connect to and click [Connect].



If the screen below is displayed, click [I want to enter the network key or passphrase instead]. Otherwise, go to step 4.

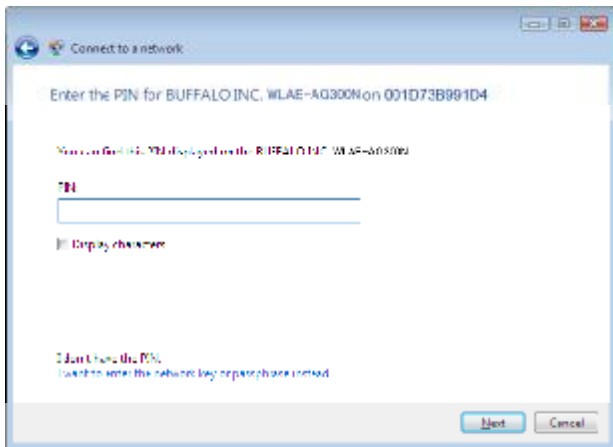
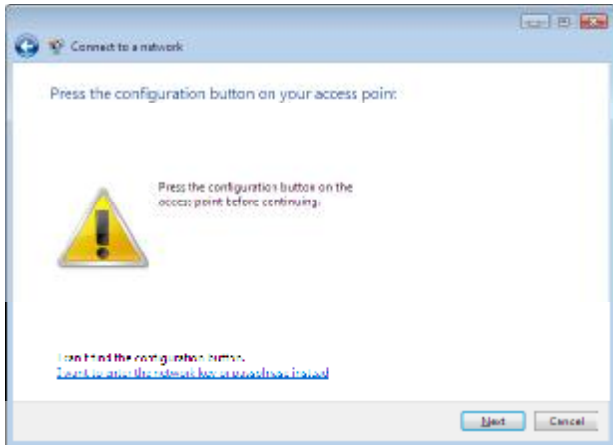

4

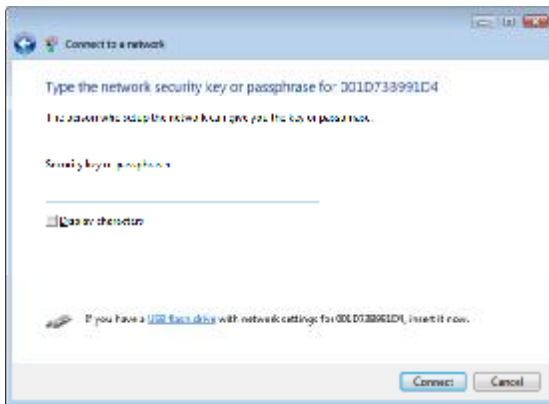

Enter the encryption key and click [Connect].

Step through the wizard to finish configuration. If the Set Network Location screen is displayed, select [Home], [Work], or [Public location] depending where you're using the AirStation.

## Windows XP (Wireless Zero Configuration)

Windows XP includes a built-in utility to connect to your AirStation.

**Note:** If Client Manager 3 is installed on your computer, Wireless Zero Config is disabled. Uninstall Client Manager 3 to use Wireless Zero Config, or just use Client Manager 3 to connect to the AirStation.

1 Right click on the wireless network icon  displayed in the system tray.

2 Click [View Available Wireless Networks].

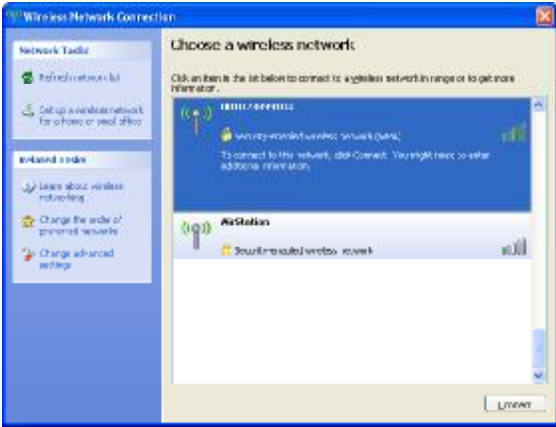
3  Select the network to connect to and click [Connect].

4  Enter the encryption key (twice) and click [Connect].

Wireless Zero Configuration will automatically connect you to the network.

## Connecting 2 WLAE-AG300Ns (Manual Setup)

To connect 2 WLAE-AG300Ns manually without using AOSS/WPS, follow the procedure below.

- 1** Refer to Chapter 4 to display the configuration screen.
- 2** When the configuration screen is displayed, refer to step 9 and later on Chapter 3, "Using AirStation As An Ethernet Converter or A Repeater".

**Note:** When using AOSS/WPS for connection, SSID or encryption key of one access point will take over the other access point, and thus they will be different from what is written on AirStation's label. The SSID and encryption key currently set can be verified on Web Configuration screen.

# Chapter 6

## Trouble Shooting

### Cannot connect to the Internet (wired connection).

- Make sure that your AirStation is plugged in!
- Check that your AirStation's LEDs are lit as below:  
Status LED is Green.  
Wireless LED is Green, Amber, or Red.
- Make sure that your computer is set to obtain an IP address automatically from DHCP. See appendix D for more on DHCP.
- Restart your AirStation.

### Cannot access the web-based configuration interface.

- See chapter 4 for instructions to open the AirStation's configuration interface.
- Enter the correct user name and password to login to the configuration interface. The factory defaults are [root] (in lower case) for the user name and a blank password (enter nothing). If you changed the password, enter the new password that you set.
- Verify that your web browser is not set to use proxies.
- Make sure that your computer is configured to obtain an IP address automatically. See appendix D for more on DHCP.
- Restart your AirStation.

### Cannot connect to the network wirelessly.

- Configure your wireless client with the same SSID, encryption type, and encryption key as set on the AirStation.  
The factory defaults are:  
SSID - The AirStation's MAC address (printed on the label)  
Encryption Type - WPA/WPA2 mixed mode - PSK (Connect with either WPA-PSK TKIP or WPA2-PSK AES).  
Encryption Key - Printed on the label of the AirStation.

**Note: Encryption is disabled by default in Asia Pacific.**

- Place your AirStation and wireless devices 2 - 10 feet apart.
- Restart your AirStation.

## **You forgot AirStation's SSID, Encryption Key, or Password.**

---

Hold down the reset button on the base of your AirStation for 3 seconds to initialize its settings. All settings, including your password, SSID, and encryption key will be initialized to their defaults. The factory defaults are:

SSID -	The AirStation's MAC address (printed on the label)
Encryption Type -	WPA/WPA2 mixed mode - PSK (Connect with either WPA-PSK TKIP or WPA2-PSK AES).
Encryption Key -	Printed on the label of the AirStation. (Encryption is disabled by default for Asia Pacific AirStations.)

## **The link speed is slower than 300 Mbps (Maximum link speed is only 130Mbps).**

---

By default, the AirStation's 300 Mbps mode is not enabled. You may enable it with the following procedure:

1. Open the configuration interface (See chapter 4).
2. Click [Wireless SSID & Channel (11n 300 Mbps Mode)] in Easy Setup.
3. Change the value in [300 Mbps Mode] - [Band Width] to 40 MHz and click [Apply].

If you still cannot connect at 300 Mbps, check the settings of your wireless client device.

## Other Tips

---

**Issue:**

I reset my AirStation to factory settings and forgot how to log in to the configuration utility.

**Answer:**

Refer to Chapter 4 to login to the AirStation's configuration screen. The user name is [root] and the password is blank by default.

**Issue:**

How do I enable or modify security encryption settings on the AirStation?

**Answer:**

Refer to Chapter 4 to login to the AirStation's configuration interface. After the configuration screen is displayed, click [Wireless Encryption (WEP/TKIP/AES)] in Easy Setup and follow the instructions on the screen.

**Issue:**

How do I change my AirStation's network name (SSID)?

**Answer:**

Refer to Chapter 4 to log in to the AirStation's web configuration interface. Click [Wireless SSID & Channel (11n300Mbps Mode)]. Change the SSID as desired and click [Apply].

**Issue:**

What can I do if my wireless connection drops randomly or seems slow?

**Answer:**

Refer to Chapter 4 to login to the AirStation's web configuration interface. Click [Wireless SSID & Channel (11n300Mbps Mode)] and set the Wireless Channel to [Auto].

**Issue:**

Though I am able to successfully make a connection with my AirStation, I am unable to access the Internet with my web browser.

**Answer:**

Restart the cable or DSL modem. Make sure that your cable or DSL modem is connected to the AirStation. Wait one minute, then restart the AirStation. Wait another minute, then reboot your computer. You should now be able to connect to the Internet. If you still cannot, refer to Appendix D to modify your computer's IP address settings.

**Issue:**

Where can I download the latest drivers, firmware and instructions for my Buffalo wireless products?

**Answer:**

The latest drivers and firmware are available online at [www.buffalotech.com](http://www.buffalotech.com)



# Appendix A

## Specifications

<b>Wireless LAN Interface</b>	
Standard Compliance	IEEE802.11a / IEEE802.11b / IEEE802.11g / IEEE802.11n
Transmission Method	Direct Sequence Spread Spectrum (DSSS), OFDM, MIMO
802.11a Frequency Range	Available 808.11a frequencies depend on the country of purchase. See the next page for details.
802.11g Frequency Range	2,412 - 2,462 MHz (Channels 1 - 11)
Transmission Rate	802.11b: 11, 5.5, 2, 1 Mbps 802.11a/g: 54, 48, 36, 24, 18, 12, 9, 6 Mbps 802.11n 20 MHz BW (LongGI) 130, 117, 104, 78, 52, 39, 26, 13 Mbps (2 stream) 65, 58.5, 52, 39, 26, 19.5, 13, 6.5 Mbps (1 stream) 40 MHz BW (LongGI) 270, 243, 216, 162, 108, 81, 54, 27 Mbps (2 stream) 135, 121.5, 108, 61, 54, 40.5, 27, 13.5 Mbps (1 stream) (ShortGI) 300 Mbps (2 stream) 150 Mbps (1 stream)
Access Mode	Infrastructure Mode
Security	AOSS, WPA2-PSK (TKIP/AES), WPA/WPA2 mixed PSK, WPA-PSK (TKIP/AES), 128/64bit WEP, Mac Address Filter
<b>Wired LAN Interface</b>	
Standard Compliance	IEEE802.3u (100BASE-TX), IEEE802.3 (10BASE-T)
Transmission Rate	10 / 100 Mbps
Transmission Encoding	100 BASE-TX 4B5B/MLT-3, 10 BASE-T Manchester Coding
Access Method	CSMA/CD
Speed and Flow Control	10 / 100 Mbps, Auto Sensing, Auto MDIX
Number of LAN Ports	2
LAN Port Connector	RJ-45

<b>Other</b>	
Power Supply	AC 100-240 V Universal, 50/60 Hz
Power Consumption	About 7.5 W (Max)
Dimensions	70 mm x 100 mm x 40 mm (2.8 x 4.0 x 1.6 in.)
Weight	198 g (7 oz.)
Operating Environment	0 - 40° C (32 - 104° F) , 20 - 80% (non-condensing)

<b>802.11a Frequency Range</b>	
USA Canada	5,180 - 5,240 MHz (Channels 36, 40, 44, 48) 5,745 - 5,825 MHz (Channels 149, 153, 157, 161, 165)
EU Kuwait Saudi Arabia UAE Oman Qatar Egypt	5,180 - 5,240 MHz (Channels 36, 40, 44, 48) 5,260 - 5,320 MHz (Channels 52, 56, 60, 64)
Singapore Australia Hong Kong The Philippines India Thailand Malaysia	5,180 - 5,240 MHz (Channels 36, 40, 44, 48) 5,260 - 5,320 MHz (Channels 52, 56, 60, 64) 5,745 - 5,825 MHz (Channels 149, 153, 157, 161, 165)
South Korea	5,180 - 5,240 MHz (Channels 36, 40, 44, 48) 5,260 - 5,320 MHz (Channels 52, 56, 60, 64) 5,500 - 5,700 MHz (Channels 100, 104, 108, 112, 116, 120, 124, 128, 132, 136, 140) 5,745 - 5,825 MHz (Channels 149, 153, 157, 161, 165)
China	5,745 - 5,825 MHz (Channels 149, 153, 157, 161, 165)
Taiwan	5,745 - 5,825 MHz (Channels 149, 153, 157, 161, 165)

## Appendix B

# Default Configuration Settings

Feature	Parameter	Default Setting
LAN	LAN Side IP Address	192.168.11.100 (255.255.255.0)
	Default Gateway	none
	DNS Server Address	none
Route	Routing Information	none
WPS	WPS	Enabled
	External Registrar	Enabled
	AirStation PIN	An 8-digit random value (Printed on the label of the AirStation)
	WPS Security Information	WPS status: configured or unconfigured SSID: AirStation's MAC Address Security: WPA/WPA2 mixedmode - PSK TKIP/AES mixedmode or none Encryption key: A 13-digit random value or disabled. (Printed on the label of the AirStation. Encryption is disabled by default settings on AirStation for Asia Pacific.)
AOSS	Encryption Type of Exclusive SSID for WEP	none
	Encryption level expansion function	Enabled
	Dedicated WEP SSID isolation	Disabled
	Allow WEP for Game Console Only	Disabled
	AOSS Button on the AirStation Unit	Enabled

Feature	Parameter	Default Setting
11n/a/g/b	Wireless	use
	Wireless Channel	Auto [All channel]
	300 Mbps Mode	Bandwidth: 20 MHz Extension Channel: -
	Broadcast SSID	Allow
	Separate feature	not used
	SSID	Use AirStation's MAC address
	Wireless authentication	WPA/WPA2 mixedmode - PSK, or no authentication
	Wireless encryption	TKIP/AES mixedmode, or no encryption
	WPA-PSK (Pre-Shared Key)	A 13-digit random value or disabled (Printed on the label of the AirStation. Encryption is disabled in default settings on AirStation for Asia Pacific.)
	Rekey interval	60 minutes
Advanced	Multicast Rate	Auto
	DTIM Period	1
	Privacy Separator	Disabled
	TPC	Disabled

Feature	Parameter	Default Setting		
WMM	WMM-EDCA Parameters (Priority AC_BK (Low) )		For AP	For STA
		CWmin	15	15
		CWmax	1023	1023
		AIFSN	7	7
		TXOP Limit	0	0
		Admission Control	----	Disabled
	WMM-EDCA Parameters (Priority AC_BE (Normal) )		For AP	For STA
		CWmin	15	15
		CWmax	63	1023
		AIFSN	3	3
		TXOP Limit	0	0
		Admission Control	----	Disabled
	WMM-EDCA Parameters (Priority AC_VI (High) )		For AP	For STA
		CWmin	7	7
		CWmax	15	15
		AIFSN	1	2
		TXOP Limit	94	94
		Admission Control	----	Disabled
	WMM-EDCA Parameters (Priority AC_VO (Highest) )		For AP	For STA
		CWmin	3	3
CWmax		7	7	
AIFSN		1	2	
TXOP Limit		47	47	
Admission Control		----	Disabled	
MAC Filter	Enforce MAC Filtering	Disabled		
	Registration List	none		
Multicast Control	Snooping	Enabled		
	Multicast Aging Time	300 Sec.		
WDS	WDS	Use		
	Specify Master/Slave	Master		
Name	AirStation Name	AP + AirStation's MAC Address		
	List Network Services	Enabled		
Password	Administrator Name	root (fixed)		
	Administrator Password	none		

Feature	Parameter	Default Setting
Time/Date	Local Date	2010 Year 1 Month 1 Day
	Local Time	0 Hour 0 Minute 0 Seconds
	Time Zone	(GMT-06:00) Central Standard Time: CST or (GMT+00:00) Greenwich Mean Time,London or (GMT+08:00) Singapore, Beijing, Hong Kong, Taipei or (GMT+09:00) Tokyo, Osaka, Seoul
NTP	NTP Functionality	Enabled
	NTP Server	time.nist.gov
	Update Interval	24 hours
ECO	Energy saving mode	Disabled
Access	Log Output	Disabled
	Limitation Item	Prohibit configuration from wireless LAN Disabled Prohibit configuration from wired LAN Disabled
Log	Log Transfer	Disabled
	Syslog Server	none
	Transfer Logs	IP Filter, DHCP Client, AOSS, Wireless Client, Authentication, Setting Changes, System Boot, NTP Client, and Wired Link

# Appendix C

## Ethernet Converter Manager

### Ethernet Converter Manager Overview

---

Ethernet Converter Manager is a tool to manage your AirStation. It lets you change the AirStation's IP address or configure WDS connection settings. To install the Ethernet Converter Manager, insert your Utility CD into your computer. On the setup screen, click [Install Ethernet Converter Application].



### Opening and Closing Ethernet Converter Manager

---

To start Ethernet Converter Manager, click [Start] > [All programs] > [BUFFALO] > [AirStation Utility] > [Ethernet Converter Manager]. To close the Ethernet Converter Manager, click [X] at the top right of the screen, or click [Exit].

## Select LAN Adapter screen

---

This screen is to select LAN Adapter which is used to setup. This screen is principally displayed when more than one wired LAN adapter is connected to a computer. If there is only one AirStation, this will not be displayed.

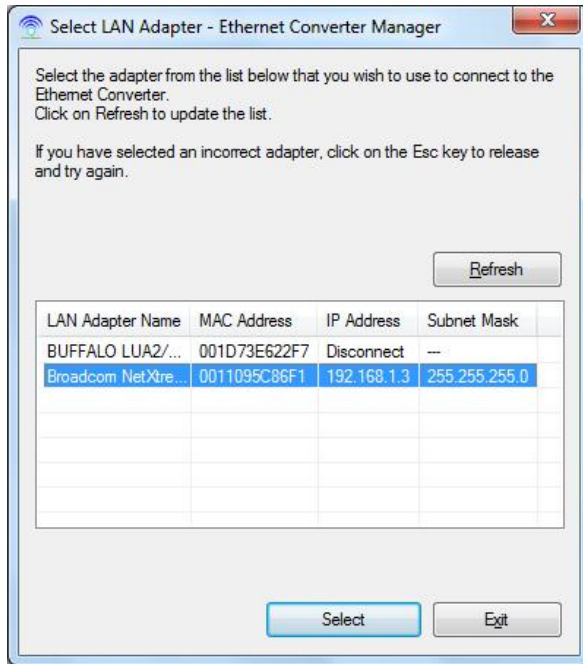

---

Parameter	Meaning
[Refresh]	Click this button to update information.
[Select]	Highlight your LAN Adapter, then click this button to configure the AirStation.
[Exit]	Closes the Ethernet Converter Manager.

---



## Select Ethernet Converter

If you have multiple AirStation Ethernet Converters on the network, they'll all be displayed here. Choose your AirStation from the list and highlight it. Click [Select].

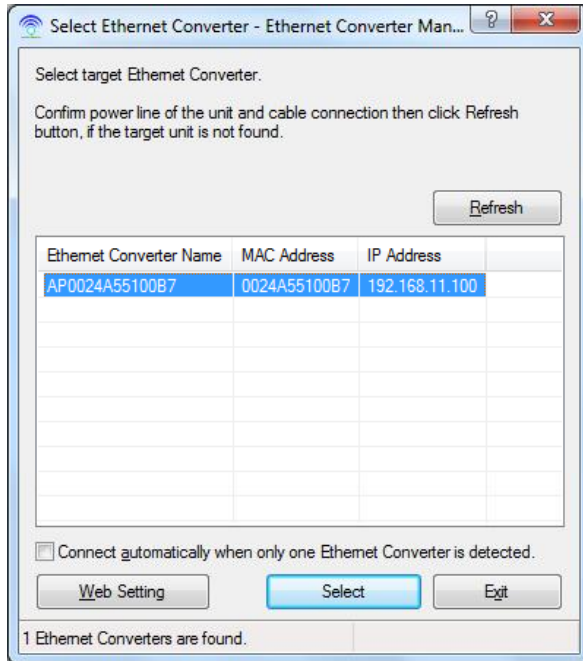

Parameter	Meaning
[Refresh]	Click this button to search and view the list of the AirStations that can be configured with this software.
Connect automatically when only one Ethernet Converter is detected	Check this option to skip this screen when there is only one AirStation that can be configured.
[Web Setting]	Click this button to display the AirStation's Web configuration interface. Note: your computer and the AirStation are on different network subnets, the IP address settings page will be displayed instead.
[Select]	Highlight your AirStation, then click this button to display the main screen.
[Exit]	Closes the Ethernet Converter Manager.

## Main Screen

Change your AirStation's IP address or other settings from this window.

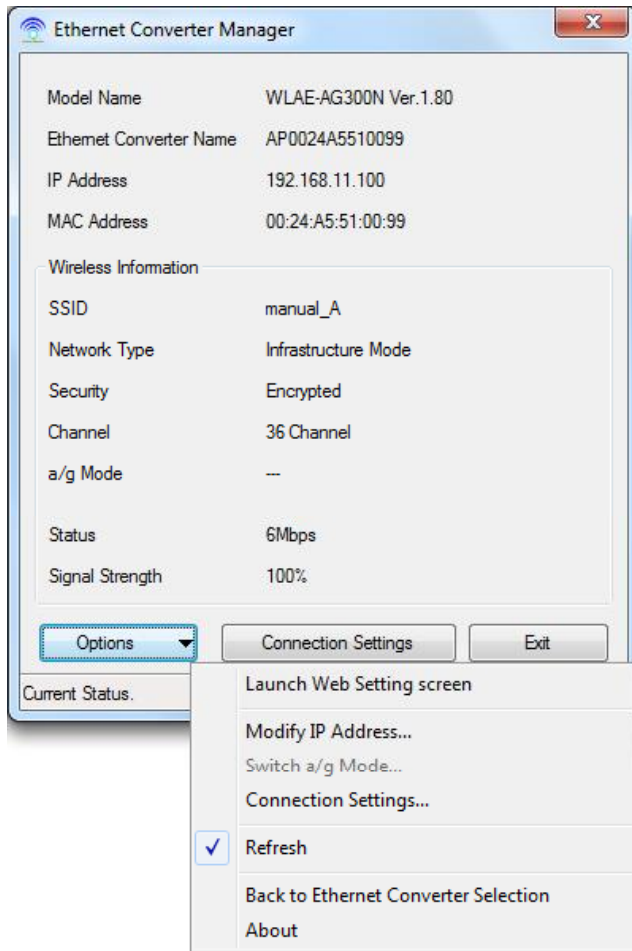

Parameter	Meaning
[Options] > [Launch Web Setting screen]	Displays the AirStation's Web configuration interface. Note: If your PC and the AirStation are on different network subnets, then the IP address configuration screen is displayed instead.
[Options] > [Modify IP Address...]	Displays the IP address configuration screen.
[Options] > [Switch a/g Mode...]	This is not supported feature for this product.
[Options] > [Connection Settings...]	Displays the connection settings screens for the access points.

<b>Parameter</b>	<b>Meaning</b>
[Options] > [Refresh]	Updates displayed information for your AirStation.
[Options] > [Back to Ethernet Converter Selection]	Takes you back to the Ethernet Converter selection screen.
[Options] > [About]	Displays the version number of your Ethernet Converter Manager.
[Connection Settings]	Display the access point connection settings screen.
[Exit]	Close Ethernet Converter Manager.

## Modify IP Address Screen

---

Modify the AirStation's IP address.

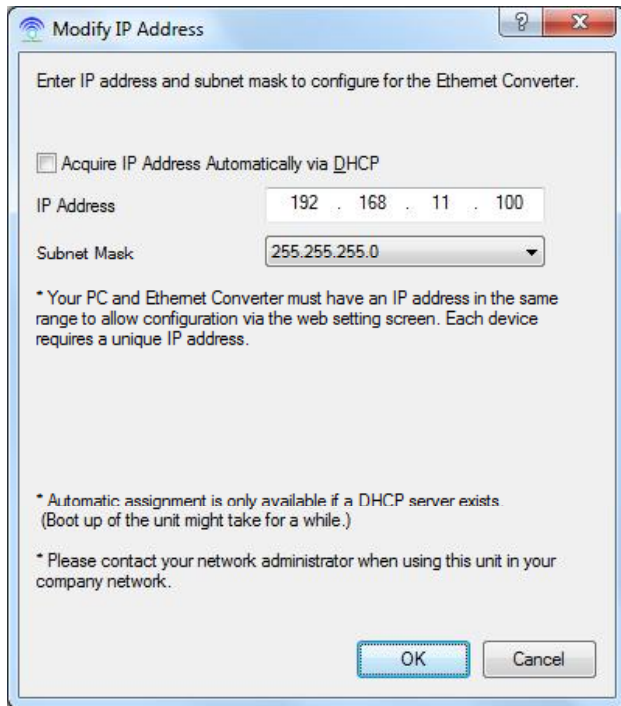

---

Parameter	Meaning
Acquire IP Address Automatically via DHCP	Check this option to automatically obtain an IP address from a DHCP server.
IP Address / Subnet Mask	If DHCP is not enabled, the you can enter an IP address and subnet mask for the AirStation manually.

---

## Connection Settings

Configure your access point's wireless connection settings.

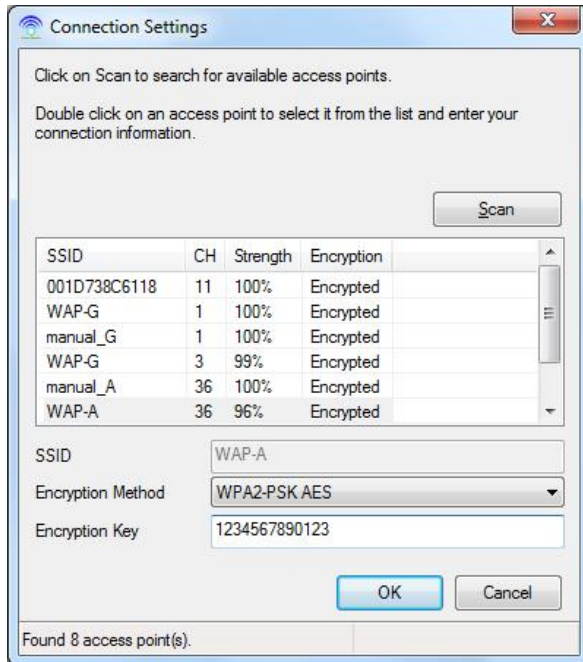

Parameter	Meaning
[Scan]	Click this button to search for available access points.
SSID	Select an access point to connect to. Double-click on an access point's SSID to select it.
Encryption method	Select the type of encryption to use.
Encryption Key	Enter the AP's encryption key.

# Appendix D

## TCP/IP Settings in Windows

### Windows 7

---

To configure TCP/IP in Windows 7, follow the procedure below.

- 1** Click [Start] > [Control Panel] > [Network and Internet].
- 2** Double click [Network and Sharing Center].
- 3** Click [Change Adapter Settings] on the left side menu.
- 4** Right click on [Local Area Connection], then click [Properties].
- 5** If the message “Windows needs your permission to continue” appears, click [Continue].
- 6** Select [Internet Protocol Version 4 (TCP/IPv4)] then click [Properties].
- 7** To have DHCP set your IP address settings automatically, check [Obtain an IP address automatically] and [Obtain DNS server address automatically].

To set your IP address settings manually, enter values for each settings. Example:

If the router's IP address is 192.168.11.1,	
IP address	192.168.11.80
Subnet mask	255.255.255.0
Default gateway	192.168.11.1
Preferred DNS server	192.168.11.1
Alternate DNS server	blank

- 8** Click [OK].

## Windows Vista

---

To configure TCP/IP in Windows Vista, follow the procedure below.

- 1** Click [Start] > [Settings] > [Control Panel].
- 2** Double click [Network and Sharing Center].
- 3** Click [Manage network connections] on the left side menu.
- 4** Right click on [Local Area Connection], then click [Properties].
- 5** When the message [Windows needs your permission to continue], click [Continue].
- 6** Select [Internet Protocol Version 4 (TCP/IPv4)], then click [Properties].
- 7** To have DHCP set your IP address settings automatically, check [Obtain an IP address automatically] and [Obtain DNS server address automatically].

To set your IP address settings manually, enter values for each settings. Example:

If the router's IP address is 192.168.11.1,	
IP address	192.168.11.80
Subnet mask	255.255.255.0
Default gateway	192.168.11.1
Preferred DNS server	192.168.11.1
Alternate DNS server	blank

- 8** Click [Close].

## Windows XP

---

To configure TCP/IP in Windows XP, follow the procedure below.

- 1** Click [Start] > [Settings] > [Control Panel].
- 2** Double click [Network].
- 3** Right click on [Local Area Connection], then click [Properties].
- 4** Select [Internet Protocol (TCP/IP)], then click [Properties].
- 5** To have DHCP set your IP address settings automatically, check [Obtain an IP address automatically] and [Obtain DNS server address automatically].

To set your IP address settings manually, enter values for each settings. Example:.

If the router's IP address is 192.168.11.1,	
IP address	192.168.11.80
Subnet mask	255.255.255.0
Default gateway	192.168.11.1
Preferred DNS server	192.168.11.1
Alternate DNS server	blank

- 6** Click [Close].



## Appendix E

# Restoring the Default Configuration

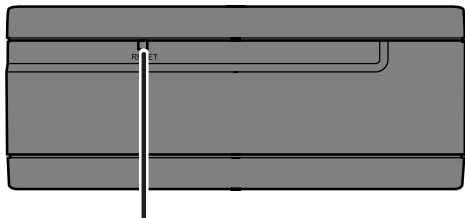

With the AirStation powered on, hold down this button for 3 seconds to return it to factory default settings.

# Appendix F

## Regulatory Compliance Information

### Federal Communication Commission Interference Statement

This equipment has been tested and found to comply with the limits for a Class B digital device, pursuant to Part 15 of the FCC Rules. These limits are designed to provide reasonable protection against harmful interference in a residential installation. This equipment generates, uses and can radiate radio frequency energy and, if not installed and used in accordance with the instructions, may cause harmful interference to radio communications. However, there is no guarantee that interference will not occur in a particular installation. If this equipment does cause harmful interference to radio or television reception, which can be determined by turning the equipment off and on, the user is encouraged to try to correct the interference by one of the following measures:

- Reorient or relocate the receiving antenna.
- Increase the separation between the equipment and receiver.
- Connect the equipment into an outlet on a circuit different from that to which the receiver is connected.
- Consult the dealer or an experienced radio/TV technician for help.

### FCC Caution:

Any changes or modifications not expressly approved by the party responsible for compliance could void the user's authority to operate this equipment.

For operation within 5.15 ~ 5.25GHz frequency range, it is restricted to indoor environment.

This device complies with Part 15 of the FCC Rules. Operation is subject to the following two conditions: (1) This device may not cause harmful interference, and (2) this device must accept any interference received, including interference that may cause undesired operation.

### Important Note - FCC Radiation Exposure Statement:

This equipment complies with FCC radiation exposure limits set forth for an uncontrolled environment. This equipment should be installed and operated with minimum distance 20cm between the radiator & your body.

This transmitter must not be co-located or operating in conjunction with any other antenna or transmitter.

The availability of some specific channels and/or operational frequency bands are country dependent and are firmware programmed at the factory to match the intended destination. The firmware setting is not accessible by the end user.

### **Industry Canada statement:**

This device complies with RSS-210 of the Industry Canada Rules. Operation is subject to the following two conditions:

- (1) This device may not cause harmful interference, and
- (2) this device must accept any interference received, including interference that may cause undesired operation.

### **Important Note - Radiation Exposure Statement:**

This equipment complies with Canada radiation exposure limits set forth for an uncontrolled environment. This equipment should be installed and operated with minimum distance 20cm between the radiator & your body.

#### **Caution:**

The device for the band 5150-5250 MHz is only for indoor usage to reduce potential for harmful interference to co-channel mobile satellite systems.

High power radars are allocated as primary users (meaning they have priority) of 5250-5350 MHz and 5650-5850 MHz and these radars could cause interference and/or damage to LE-LAN devices.

### **Europe – EU Declaration of Conformity**

This device complies with the essential requirements of the R&TTE Directive 1999/5/EC. The following test methods have been applied in order to prove presumption of conformity with the essential requirements of the R&TTE Directive 1999/5/EC:

EN60950-1: (2006)

Safety of Information Technology Equipment

EN50385 : (2002-08)

Product standard to demonstrate the compliance of radio base stations and fixed terminal stations for wireless telecommunication systems with the basic restrictions or the reference levels related to human exposure to radio frequency electromagnetic fields (110MHz - 40 GHz) - General public

EN 300 328 V1.7.1: (2006-10)

Electromagnetic compatibility and Radio spectrum Matters (ERM); Wideband Transmission systems; Data transmission equipment operating in the 2,4 GHz ISM band and using spread spectrum modulation techniques; Harmonized EN covering essential requirements under article 3.2 of the R&TTE Directive

EN 301 893 V1.5.1: (2008-12)

Broadband Radio Access Networks (BRAN); 5 GHz high performance RLAN; Harmonized EN covering the essential requirements of article 3.2 of the R&TTE Directive

EN 301 489-1 V1.8.1: (2008-04)

Electromagnetic compatibility and Radio Spectrum Matters (ERM); ElectroMagnetic Compatibility (EMC) standard for radio equipment and services; Part 1: Common technical requirements

EN 301 489-17 V2.1.1 (2009-05)

Electromagnetic compatibility and Radio spectrum Matters (ERM); ElectroMagnetic Compatibility (EMC) standard for radio equipment; Part 17: Specific conditions for Broadband Data Transmission Systems

This device is a 2.4 GHz wideband transmission system (transceiver), intended for use in all EU member states and EFTA countries, except in France and Italy where restrictive use applies.

In Italy the end-user should apply for a license at the national spectrum authorities in order to obtain authorization to use the device for setting up outdoor radio links and/or for supplying public access to telecommunications and/or network services.

This device may not be used for setting up outdoor radio links in France and in some areas the RF output power may be limited to 10 mW EIRP in the frequency range of 2454 – 2483.5 MHz. For detailed information the end-user should contact the national spectrum authority in France.

**CE 0560** 

Česky[Czech]

Buffalo Technology Inc. tímto prohlašuje, že tento AirStation WLAE-AG300N je ve shodě se základními požadavky a dalšími příslušnými ustanoveními směrnice 1999/5/ES.

Dansk[Danish]

Undertegnede Buffalo Technology Inc. erklærer herved, at følgende udstyr AirStation WLAE-AG300N overholder de væsentlige krav og øvrige relevante krav i direktiv 1999/5/EF.

Deutsch[German]

Hiermit erklärt Buffalo Technology Inc. dass sich das Gerät AirStation WLAE-AG300N in Übereinstimmung mit den grundlegenden Anforderungen und den übrigen einschlägigen Bestimmungen der Richtlinie 1999/5/EG befindet.

Eesti[Estonian]

Käesolevaga kinnitab Buffalo Technology Inc. seadme AirStation WLAE-AG300N vastavust direktiivi 1999/5/EÜ põhinõuetele ja nimetatud direktiivist tulenevatele teistele asjakohastele sätetele.

English

Hereby, Buffalo Technology Inc. declares that this AirStation WLAE-AG300N is in compliance with the essential requirements and other relevant provisions of Directive 1999/5/EC.

Español[Spanish]

Por medio de la presente Buffalo Technology Inc. declara que el AirStation WLAE-AG300N cumple con los requisitos esenciales y cualesquiera otras disposiciones aplicables o exigibles de la Directiva 1999/5/CE.

Ελληνική[Greek]

ΜΕ ΤΗΝ ΠΑΡΟΥΣΑ Buffalo Technology Inc. ΔΗΛΩΝΕΙ ΟΤΙ AirStation WLAE-AG300N ΣΥΜΜΟΡΦΩΝΕΤΑΙ ΠΡΟΣ ΤΙΣ ΟΥΣΙΩΔΕΙΣ ΑΠΑΙΤΗΣΕΙΣ ΚΑΙ ΤΙΣ ΛΟΙΠΕΣ ΣΧΕΤΙΚΕΣ ΔΙΑΤΑΞΕΙΣ ΤΗΣ ΟΔΗΓΙΑΣ 1999/5/ΕΚ.

Français[French]

Par la présente Buffalo Technology Inc. déclare que l'appareil AirStation WLAE-AG300N est conforme aux exigences essentielles et aux autres dispositions pertinentes de la directive 1999/5/CE.

Italiano[Italian]

Con la presente Buffalo Technology Inc. dichiara che questo AirStation WLAE-AG300N è conforme ai requisiti essenziali ed alle altre disposizioni pertinenti stabilite dalla direttiva 1999/5/CE.

Latviski[Latvian]

Ar šo Buffalo Technology Inc. deklarē, ka AirStation WLAE-AG300N atbilst Direktīvas 1999/5/EK būtiskajām prasībām un citiem ar to saistītajiem noteikumiem.

Lietuvių[Lithuanian]

Šiuo Buffalo Technology Inc. deklaruoja, kad šis AirStation WLAE-AG300N atitinka esminius reikalavimus ir kitas 1999/5/EB Direktyvos nuostatas.

Nederlands[Dutch]

Hierbij verklaart Buffalo Technology Inc. dat het toestel AirStation WLAE-AG300N in overeenstemming is met de essentiële eisen en de andere relevante bepalingen van richtlijn 1999/5/EG.

Malti[Maltese]

Hawnhekk, Buffalo Technology Inc. , jiddikjara li dan AirStation WLAE-AG300N jikkonforma mal-ħtiġijiet essenzjali u ma provvedimenti oħrajn rilevanti li hemm fid-Dirrettiva 1999/5/EC.

Magyar[Hungarian]

Alulírott, Buffalo Technology Inc. nyilatkozom, hogy a AirStation WLAE-AG300N megfelel a vonatkozó alapvető követelményeknek és az 1999/5/EC irányelv egyéb előírásainak.

Polski[Polish]

Niniejszym Buffalo Technology Inc. oświadcza, że AirStation WLAE-AG300N jest zgodny z zasadniczymi wymogami oraz pozostałymi stosownymi postanowieniami Dyrektywy 1999/5/EC.

Português[Portuguese]

Buffalo Technology Inc. declara que este AirStation WLAE-AG300N está conforme com os requisitos essenciais e outras disposições da Directiva 1999/5/CE.

Slovensko[Slovenian]

Buffalo Technology Inc. izjavlja, da je ta AirStation WLAE-AG300N v skladu z bistvenimi zahtevami in ostalimi relevantnimi določili direktive 1999/5/ES.

Slovensky[Slovak]

Buffalo Technology Inc. týmto vyhlasuje, že AirStation WLAE-AG300N spĺňa základné požiadavky a všetky príslušné ustanovenia Smernice 1999/5/ES.

Suomi[Finnish]

Buffalo Technology Inc. vakuuttaa täten että AirStation WLAE-AG300N tyyppinen laite on direktiivin 1999/5/EY oleellisten vaatimusten ja sitä koskevien direktiivin muiden ehtojen mukainen.

Svensk[Swedish]

Härmed intygar Buffalo Technology Inc. att denna AirStation WLAE-AG300N står i överensstämmelse med de väsentliga egenskapskrav och övriga relevanta bestämmelser som framgår av direktiv 1999/5/EG.

## Taiwan:

SAR compliance has been established in typical laptop computer(s) with CardBus slot, and product could be used in typical laptop computer with CardBus slot. Other application like handheld PC or similar device has not been verified, may not comply with related RF exposure rules, and such use shall be prohibited.

## Safety

This equipment is designed with the utmost care for the safety of those who install and use it. However, special attention must be paid to the dangers of electric shock and static electricity when working with electrical equipment. All guidelines of this manual and of the computer manufacturer must therefore be allowed at all times to ensure the safe use of the equipment.

## 根據 NCC 低功率電波輻射性電機管制辦法：

### 第十二條：

經型式認證合格之低功率射頻電機，非經許可，公司、商號或使用者均不得擅自變更頻率、加大功率或變更原設計之特性及功能。

### 第十四條：

低功率射頻電機之使用不得影響飛航安全及干擾合法通信；經發現有干擾現象時，應立即停用，並改善至無干擾時方得繼續使用。前項合法通信，指依電信法規定作業之無線電通信。低功率射頻電機須忍受合法通信或工業、科學及醫療用電波輻射性電機設備之干擾。

5.25-5.35 兆赫頻帶內操作之無線資訊傳輸設備，限於室內使用。

이 기기는 가정용으로 전자파적합등록을 한 기기로서 주거지역에서는 물론 모든 지역에서 사용할 수 있습니다.

해당 무선설비는 전파혼신 가능성이 있으므로 인명안전과 관련된 서비스는 할 수 없음

법에 의해 전방향 전파발사 및 동일한 정보를 동시에 여러 곳으로 송신하는 점-대-다지 점 서비스에의 사용은 금지되어 있습니다.

# Appendix G

## Environmental Information

- The equipment that you have purchased has required the extraction and use of natural resources for its production.
- The equipment may contain hazardous substances that could impact health and the environment.
- In order to avoid the dissemination of those substances in our environment and to diminish the pressure on the natural resources, we encourage you to use the appropriate take-back systems.
- The take-back systems will reuse or recycle most of the materials of your end life equipment in a sound way.
- The crossed-out wheeled bin symbol invites you to use those systems.



- If you need more information on the collection, reuse and recycling systems, please contact your local or regional waste administration.



# Appendix H

## GPL Information

The source code for Buffalo products that use GPL code is available at <http://opensource.buffalo.jp/>.

# Appendix I

## Warranty Information

Buffalo Technology (Buffalo Inc.) products come with a two-year limited warranty from the date of purchase. Buffalo Technology (Buffalo Inc.) warrants to the original purchaser the product; good operating condition for the warranty period. This warranty does not include non-Buffalo Technology (Buffalo Inc.) installed components. If the Buffalo product malfunctions during the warranty period, Buffalo Technology/(Buffalo Inc.) will, replace the unit, provided the unit has not been subjected to misuse, abuse, or non-Buffalo Technology/(Buffalo Inc.) authorized alteration, modifications or repair.

All expressed and implied warranties for the Buffalo Technology (Buffalo Inc) product line including, but not limited to, the warranties of merchantability and fitness of a particular purpose are limited in duration to the above period.

Under no circumstances shall Buffalo Technology/(Buffalo Inc.) be liable in any way to the user for damages, including any lost profits, lost savings or other incidental or consequential damages arising out of the use of, or inability to use the Buffalo products.

In no event shall Buffalo Technology/(Buffalo Inc.) liability exceed the price paid for the product from direct, indirect, special, incidental, or consequential damages resulting from the use of the product, its accompanying software, or its documentation. Buffalo Technology (Buffalo Inc.) does not offer refunds for any product.

@ 2003-2010 Buffalo Technology (Buffalo, Inc.)

# Appendix J

## Contact Information

### North America

---

Buffalo Technology USA Inc.  
11100 Metric Blvd, Suite 750  
Austin, TX 78758

#### GENERAL INQUIRIES

Monday through Friday  
8:30am-5:30pm CST

**Direct:** 512-794-8533 | **Toll-free:** 800-456-9799 | **Fax:** 512-794-8520 |

**Email:** [sales@buffalotech.com](mailto:sales@buffalotech.com)

#### TECHNICAL SUPPORT

North American Technical Support by phone is available 24 hours a day, 7 days a week. (USA and Canada).

**Toll-free:** (866) 752-6210 | **Email:** [info@buffalotech.com](mailto:info@buffalotech.com)

## Europe

---

Buffalo Technology UK Ltd.  
2 Bracknell Beeches, Old Bracknell Lane  
Bracknell, Berkshire, RG 12 7BW  
United Kingdom

### **GENERAL INQUIRIES**

*Email: [sales@buffalo-technology.com](mailto:sales@buffalo-technology.com)*

### **TECHNICAL SUPPORT**

Buffalo Technology provides technical support in English, German, French, Italian, and Spanish.

UK	0845 3511005
Austria	08101 0251552
Belgium	0787 99917
Denmark	70150919
Finland	010802812
France	0811 650220
Germany	01801 003757
Ireland	1890 719901
Italy	848 782113
Netherlands	09000401256
Norway	81000050
Spain	9018 10750
Sweden	0771404105
Switzerland	0848 560374

For all other regions please contact +353 61 704617

*[www.buffalo-technology.com/contact](http://www.buffalo-technology.com/contact)*

---

## Contact Information (Asia Pacific)

---

Australia	TEL: 1300 761 310 e-mail: buffalo_support@uniden.com.au
China	TEL: 86-800-820-8262 e-mail: support@buffalo-china.com
Hong Kong	TEL: 852-2345-0005 e-mail: support@hornington.com
India	TEL: 1-8004256210 e-mail: csbuffalo@accelfrontline.in
Indonesia	TEL: 021-6231-2893
Malaysia	TEL: 03-5032-0138 e-mail: buffalo@ecsm.com.my
Philippines	TEL: 2-688-3999 e-mail: digisupport@msi-ecs.com.ph
Republic of Korea	TEL: 02-2057-2095 e-mail: support@buffalotech.co.kr
Singapore	TEL: 65-6297-2085 e-mail: buffalo@blumm.com
Taiwan	TEL: 0800-660-886 e-mail: support@buffalo-tech.com.tw
Thailand	TEL: 02-716-6669
Other Areas	Please contact the shop or distributor where you purchased the unit, referring to the attached warranty card issued by the distributor.