

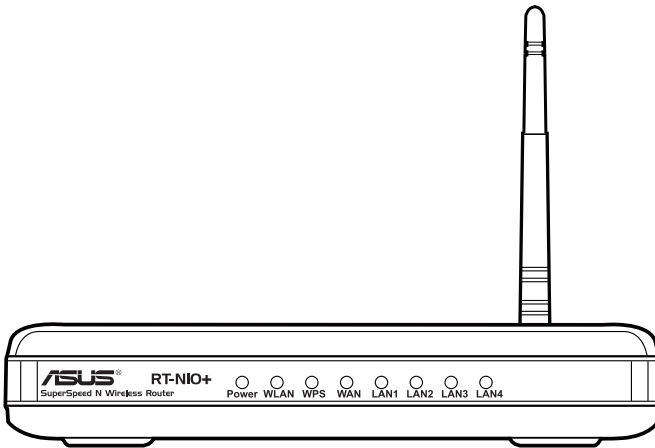

RT-N10+ EZ N Router



User Manual

E5866

Revised Edition

May 2010

Copyright © 2010 ASUSTeK Computer Inc. All Rights Reserved.

No part of this manual, including the products and software described in it, may be reproduced, transmitted, transcribed, stored in a retrieval system, or translated into any language in any form or by any means, except documentation kept by the purchaser for backup purposes, without the express written permission of ASUSTeK Computer Inc. ("ASUS").

Product warranty or service will not be extended if: (1) the product is repaired, modified or altered, unless such repair, modification of alteration is authorized in writing by ASUS; or (2) the serial number of the product is defaced or missing.

ASUS PROVIDES THIS MANUAL "AS IS" WITHOUT WARRANTY OF ANY KIND, EITHER EXPRESS OR IMPLIED, INCLUDING BUT NOT LIMITED TO THE IMPLIED WARRANTIES OR CONDITIONS OF MERCHANTABILITY OR FITNESS FOR A PARTICULAR PURPOSE. IN NO EVENT SHALL ASUS, ITS DIRECTORS, OFFICERS, EMPLOYEES OR AGENTS BE LIABLE FOR ANY INDIRECT, SPECIAL, INCIDENTAL, OR CONSEQUENTIAL DAMAGES (INCLUDING DAMAGES FOR LOSS OF PROFITS, LOSS OF BUSINESS, LOSS OF USE OR DATA, INTERRUPTION OF BUSINESS AND THE LIKE), EVEN IF ASUS HAS BEEN ADVISED OF THE POSSIBILITY OF SUCH DAMAGES ARISING FROM ANY DEFECT OR ERROR IN THIS MANUAL OR PRODUCT.

SPECIFICATIONS AND INFORMATION CONTAINED IN THIS MANUAL ARE FURNISHED FOR INFORMATIONAL USE ONLY, AND ARE SUBJECT TO CHANGE AT ANY TIME WITHOUT NOTICE, AND SHOULD NOT BE CONSTRUED AS A COMMITMENT BY ASUS. ASUS ASSUMES NO RESPONSIBILITY OR LIABILITY FOR ANY ERRORS OR INACCURACIES THAT MAY APPEAR IN THIS MANUAL, INCLUDING THE PRODUCTS AND SOFTWARE DESCRIBED IN IT.

Products and corporate names appearing in this manual may or may not be registered trademarks or copyrights of their respective companies, and are used only for identification or explanation and to the owners' benefit, without intent to infringe.

Offer to Provide Source Code of Certain Software

This product contains copyrighted software that is licensed under the General Public License ("GPL"), under the Lesser General Public License Version ("LGPL") and/or other Free Open Source Software Licenses. Such software in this product is distributed without any warranty to the extent permitted by the applicable law. Copies of these licenses are included in this product.

Where the applicable license entitles you to the source code of such software and/or other additional data, such data should have been shipped along with this product.

You may also download it for free from <http://support.asus.com/download>.

The source code is distributed WITHOUT ANY WARRANTY and licensed under the same license as the corresponding binary/object code.

ASUSTeK is eager to duly provide complete source code as required under various Free Open Source Software licenses. If however you encounter any problems in obtaining the full corresponding source code we would be much obliged if you give us a notification to the email address gpl@asus.com, stating the product and describing the problem (please do NOT send large attachments such as source code archives etc to this email address).

Table of contents

About this guide	4
How this guide is organized	4
Conventions used in this guide	5
Chapter 1: Knowing your wireless router	
Package contents	6
System requirements	6
Before you proceed	6
Hardware features	7
Front panel	7
Rear panel.....	8
Bottom panel.....	9
Mounting options	10
Chapter 2: Getting started	
Setting up the wireless router	11
Using the Quick Internet Setup (QIS)	11
Setting up the wireless router in Router mode.....	12
Setting up the wireless router in AP mode	15
Chapter 3: Configuring the network clients	
Accessing the wireless router	17
Setting an IP address for wired or wireless clients.....	17
Chapter 4: Configuring via the web GUI	
Configuring via the web GUI	21
Using the Network Map	23
Creating multiple SSID profiles	24
Managing bandwidth with EzQoS	25
Upgrading the firmware	26
Restoring/Saving/Uploading settings	27

Table of contents

Chapter 5: Installing the utilities	
Installing the utilities	28
Device Discovery	30
Firmware Restoration	31
WPS Wizard	32
Using WPS Wizard	32
Chapter 6: Troubleshooting	
Troubleshooting	38
ASUS DDNS Service	41
Frequently Asked Questions (FAQs)	41
Appendices	
Notices	43
ASUS Contact Information	51

About this guide

This user guide contains information that you need to install and configure the ASUS Wireless Router.

How this guide is organized

This guide contains the following parts:

- **Chapter 1: Knowing your wireless router**

This chapter provides information on the package contents, system requirements, hardware features, and LED indicators of the ASUS Wireless Router.

- **Chapter 2: Getting started**

This chapter provides instructions on setting up the Router and Access Point modes of the ASUS Wireless Router.

- **Chapter 3: Configuring the network clients**

This chapter provides instructions on setting up the clients in your network to work with your ASUS Wireless Router.

- **Chapter 4: Configuring via the web GUI**

This chapter provides instructions on configuring the ASUS Wireless Router using its web graphics user interface (web GUI).

- **Chapter 5: Installing the utilities**

This chapter provides information on the utilities that are available from the support CD.

- **Chapter 6: Troubleshooting**

This chapter provides you with a troubleshooting guide for solving common problems you may encounter when using the ASUS Wireless Router.

- **Appendices**

This chapter provides you with the regulatory Notices and Safety Statements.

Conventions used in this guide



WARNING: Information to prevent injury to yourself when trying to complete a task.



CAUTION: Information to prevent damage to the components when trying to complete a task.



IMPORTANT: Instructions that you **MUST** follow to complete a task.



NOTE: Tips and additional information to aid in completing a task.

1

Knowing your wireless router

Package contents

Check the following items in your ASUS Wireless Router package.

- RT-N10+ Wireless Router x1
- Power adapter x1
- Support CD (manual, utilities) x1
- RJ45 cable x1
- Quick Start Guide x1



Note: If any of the items is damaged or missing, contact your retailer.

System requirements

Before installing the ASUS Wireless Router, ensure that your system/network meets the following requirements:

- An Ethernet RJ-45 port (10Base-T/100Base-TX)
- At least one IEEE 802.11b/g/n device with wireless capability
- An installed TCP/IP and Internet browser

Before you proceed

Take note of the following guidelines before installing the ASUS Wireless Router:

- The length of the Ethernet cable that connects the device to the network (hub, ADSL/cable modem, router, wall patch) must not exceed 100 meters.
- Place the device on a flat and stable surface as far from the ground as possible.
- Keep the device clear from metal obstructions and away from direct sunlight.
- Keep the device away from transformers, heavy-duty motors, fluorescent lights, microwave ovens, refrigerators, and other industrial equipment to prevent signal loss.
- Install the device in a central area to provide ideal coverage for all wireless mobile devices.

- Install the device at least 20cm from a person to insure that the product is operated in accordance with the RF Guidelines for Human Exposure adopted by the Federal Communications Commission.

Hardware features

Front panel

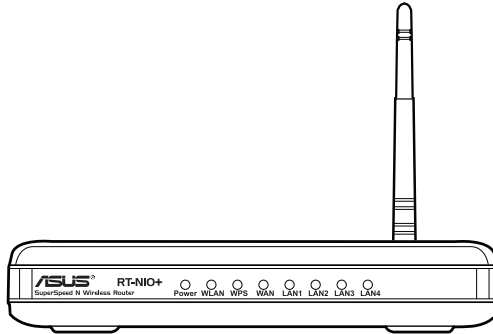

Status indicators

LED	Status	Indication
Power	Off	No power
	On	System ready
	Flashing	Rescue mode
WLAN	Off	No power
	On	Wireless system ready
	Flashing	Transmitting or receiving data (wireless)
WPS	Flashing	WPS processing
LAN 1-4 (Local Area Network)	Off	No power or no physical connection
	On	Has physical connection to an Ethernet network
	Flashing	Transmitting or receiving data (through Ethernet cable)
WAN (Wide Area Network)	Off	No power or no physical connection
	On	Has physical connection to an Ethernet network
	Flashing	Transmitting or receiving data (through Ethernet cable)

Rear panel

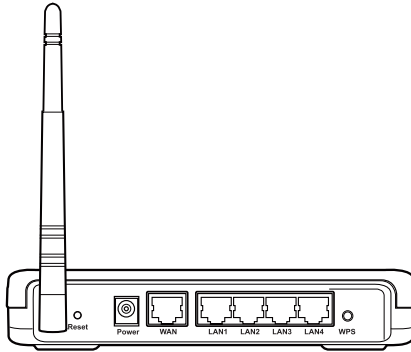

Label	Description
WAN	Connect an RJ-45 Ethernet cable to this port to establish WAN connection.
LAN1-LAN4	Connect RJ-45 Ethernet cables to these ports to establish LAN connection.
Power	Insert the AC adapter into this port to connect your router to a power source.
WPS	Press this button to establish wireless connection.
Reset	Press this button for more than five seconds to reset the system to its factory default settings.

Bottom panel

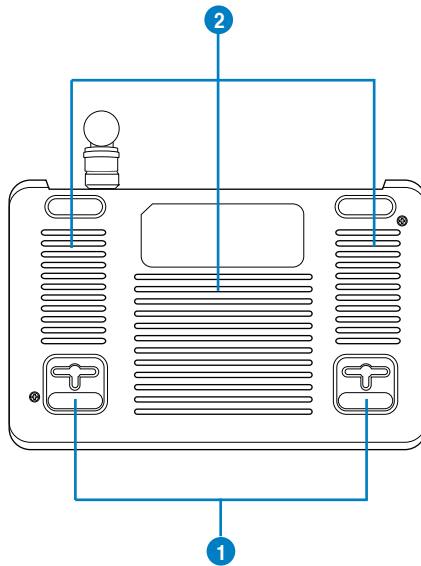

Item	Description
1	Mounting hooks Use the mounting hooks to mount your router on concrete or wooden surfaces using two round head screws.
2	Air vents These vents provide ventilation to your router.



Note: For details on mounting your router on a wall or ceiling, refer to the section **Mounting options** on the next page of this user manual.

Mounting options

Out of the box, the ASUS Wireless Router is designed to sit on a raised flat surface like a file cabinet or book shelf. The unit may also be converted for mounting to a wall or ceiling.

To mount the ASUS Wireless Router:

1. Look on the underside for the two mounting hooks.
2. Mark two upper holes in a flat surface.
3. Tighten two screws until only 1/4" is showing.
4. Latch the hooks of the ASUS Wireless Router onto the screws.

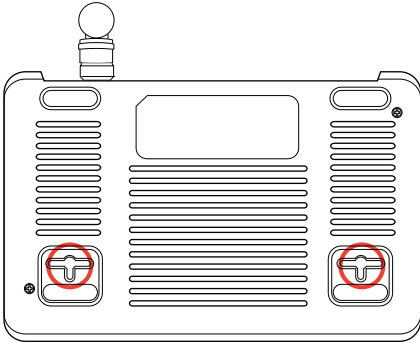

Note: Re-adjust the screws if you cannot latch the ASUS Wireless Router onto the screws or if it is too loose.

Getting started 2

Setting up the wireless router

The ASUS Wireless Router includes a web graphics user interface (web GUI) that allows you to configure the wireless router using your web browser on your computer.



Note: For details on configuring your wireless router using the web GUI, refer to **Chapter 4: Configuring via the web GUI**.

You can set up the wireless router in either of these two operation modes: Router (IP Sharing) and Access Point (AP). Set up these two operation modes via the Quick Internet Setup (QIS).

Using the Quick Internet Setup (QIS)

The Quick Internet Setup (QIS) function, which is integrated in the wireless router's web GUI, detects the Internet connection type automatically and guides you in setting up your network quickly.

The QIS web page appears automatically after you connected all your devices and launched your web browser. You may also launch the QIS from the Network Map page in the web GUI. To do this, click **Go** in the QIS field under Internet status.

Setting up the wireless router in Router mode

In the Router mode, the wireless router connects to the Internet via PPPoE, Automatic IP, PPTP, L2TP, or Static IP, and provides you with wireless radio signals. The NAT, firewall, and IP sharing services for LAN clients are enabled.

To set up the wireless router in Router mode:

1. Connect your devices.

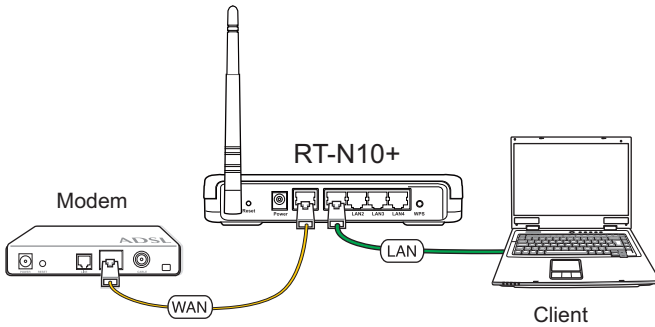

Note: We recommend that you use an Ethernet cable (wired connection) to connect your computer to the wireless router for initial configuration to avoid possible setup problems due to wireless uncertainty.

2. Launch your web browser and the QIS web page appears automatically. Select **IP Sharing mode**, then click **Next**.



Note: If the QIS web page does not appear after you launched your web browser, disable the proxy settings on your web browser.

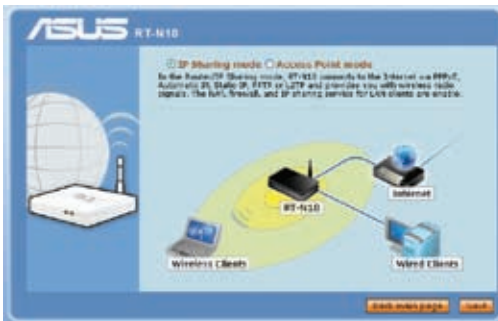

Then the QIS starts to detect your Internet connection type.



3. Key in the user name and password. Click **Apply all settings**.



Note:

- The PPPoE Internet connection type is used in this setup case. The setup screen varies with different Internet connection types.
 - Obtain the required information such as the user name and password from your Internet Service Provider (ISP).
-

4. The Internet connection setup is completed.

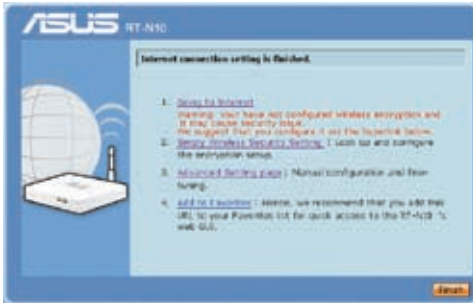

- Click **Going to Internet** to surf the Internet.
- Click **Simple Wireless Security Setting** to configure the basic security settings including the SSID, authentication, and encryption methods for the wireless router.



- Click **Advanced Setting page** to manually configure advanced settings for the wireless router.
- Click **Add to Favorites** to add this URL to your Favorites list for quick access to the web GUI.

Setting up the wireless router in AP mode

In the AP mode, the wireless router receives the WAN IP address from the router connected to the WAN port and provides you with wireless radio signals. The NAT, firewall, and IP sharing services are disabled.

To set up the wireless router in AP mode:

1. Connect your devices.

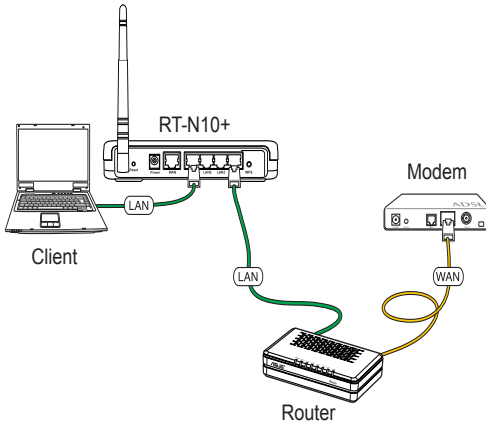

Note: We recommend that you use an Ethernet cable (wired connection) to connect your computer to the wireless router for initial configuration to avoid possible setup problems due to wireless uncertainty.

2. Launch your web browser and the QIS web page appears automatically. Select **Access Point mode**, then click **Next**.



Note: If the QIS web page does not appear after you launched your web browser, disable the proxy settings on your web browser.

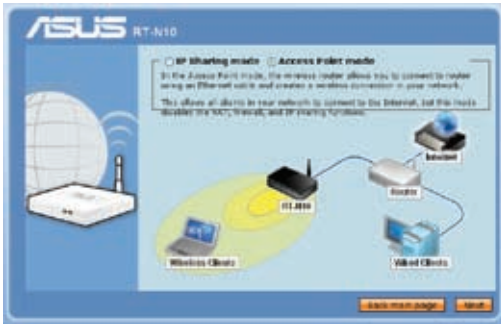

3. Configure the wireless security settings including the SSID, authentication, and encryption methods. Click **Finish**.



3 Configuring the network clients

Accessing the wireless router

Setting an IP address for wired or wireless clients

To access the ASUS Wireless Router, you must have the correct TCP/IP settings on your wired or wireless clients. Ensure that the clients' IP addresses are within the same subnet as the ASUS Wireless Router.

By default, the ASUS Wireless Router integrates the DHCP server function, which automatically assigns IP addresses to the clients in your network.

But in some instances, you may want to manually assign static IP addresses on some of the clients or computers in your network rather than automatically getting IP addresses from your wireless router.

Follow the instructions below that correspond to the operating system installed on your client or computer.



Note: In the Router mode, if you want to manually assign an IP address to your client, we recommend that you use the following settings:

- **IP address:** 192.168.1.xxx (xxx can be any number between 2 and 254. Ensure that the IP address is not used by another device)
 - **Subnet Mask:** 255.255.255.0 (same as the ASUS Wireless Router)
 - **Gateway:** 192.168.1.1 (IP address of the ASUS Wireless Router)
 - **DNS:** 192.168.1.1 (ASUS Wireless Router) or assign a known DNS server in your network
-

Windows® 2000

1. Click **Start > Control Panel > Network and Dial-up Connection**. Right-click **Local Area Connection** then click **Properties**.

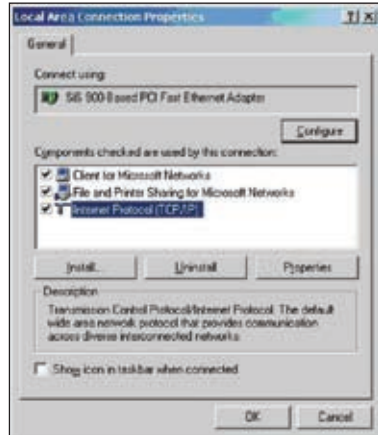

2. Select **Internet Protocol (TCP/IP)**, then click **Properties**.
3. Select **Obtain an IP address automatically** if you want the IP settings to be assigned automatically. Otherwise, select **Use the following IP address:** and key in **IP address**, **Subnet mask**, and **Default gateway**.
4. Select **Obtain DNS server address automatically** if you want the DNS server settings to be assigned automatically. Otherwise, select **Use the following DNS server addresses:** and key in the **Preferred** and **Alternate DNS server**.
5. Click **OK** when done.

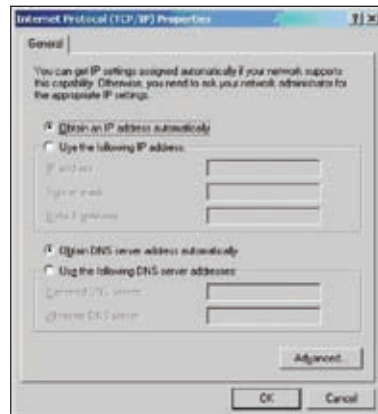

Windows® XP

1. Click **Start > Control Panel > Network Connection**. Right-click **Local Area Connection** then select **Properties**.



2. Select **Internet Protocol (TCP/IP)**, then click **Properties**.
3. Select **Obtain an IP address automatically** if you want the IP settings to be assigned automatically. Otherwise, select **Use the following IP address**: and key in **IP address**, **Subnet mask**, and **Default gateway**.
4. Select **Obtain DNS server address automatically** if you want the DNS server settings to be assigned automatically. Otherwise, select **Use the following DNS server addresses**: and key in the **Preferred and Alternate DNS server**.
5. Click **OK** when done.



Windows® Vista/7

1. Go to **Start > Control Panel > Network and Internet > Network and Sharing Center**. Click **View status > Properties > Continue**.

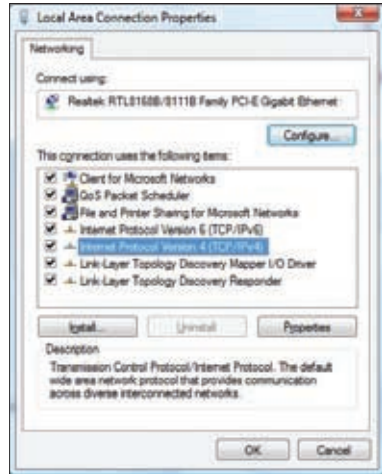

2. Select **Internet Protocol Version 4 (TCP/IPv4)**, then click **Properties**.
3. Select **Obtain an IP address automatically** if you want the IP settings to be assigned automatically. Otherwise, select **Use the following IP address:** and key in **IP address** and **Subnet mask**.
4. Select **Obtain DNS server address automatically** if you want the DNS server settings to be assigned automatically. Otherwise, select **Use the following DNS server addresses:** and key in the **Preferred and Alternate DNS server**.
5. Click **OK** when done.



4 Configuring via the web GUI

Configuring via the web GUI

The router's web graphics user interface (web GUI) allows you to configure these features: **Network Map** and **EZQoS Bandwidth Management**.

To access the web GUI:

1. Launch a web browser, then key in the router's IP address. The login page of the router's web GUI appears.



Note:

- In the Router mode, the router's IP address is 192.168.1.1.
 - In the AP mode, use Device Discovery included in the support CD to find the router's IP address.
-

2. On the login page, key in the default user name (**admin**) and password (**admin**).



- 3. From the main page, click the navigation menu or links to configure the various features of the ASUS Wireless Router.





Using the Network Map

Network Map allows you to view the status and configure the connection settings of the Internet, system, and clients in your network. It enables you to quickly set up your Wide Area Network (WAN) using the Quick Internet Setup (QIS) feature, or to quickly set up your Local Area Network (LAN) using the WPS Wizard.



Note: For more details on the WPS Wizard, refer to the section **WPS Wizard** in Chapter 5 of this user manual.

To view the status or configure the settings, click any of these icons displayed on the main page:

Icon	Description
	Internet status Click this icon to display information on the Internet connection status, WAN IP address, DNS, connection type, and gateway address. From the Internet status screen, use the Quick Internet Setup (QIS) feature to quickly set up your WAN.
	System status Click this icon to display information on the SSID, authentication and encryption methods, LAN IP, MAC address, or turn the wireless radio on/off. Enable the WPS mode from the System status screen.
	Client status Click this icon to display information about the clients or computers in the network, and allows you to block/unblock a client.

Creating multiple SSID profiles

The wireless router allows you to create multiple SSID profiles that meet various working scenarios.

To create an SSID profile:

1. Under **System status**, click **Add**.

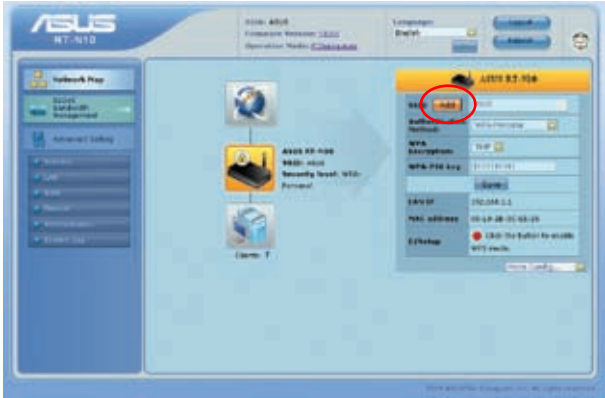

2. Configure the profile settings, then click **Add**.

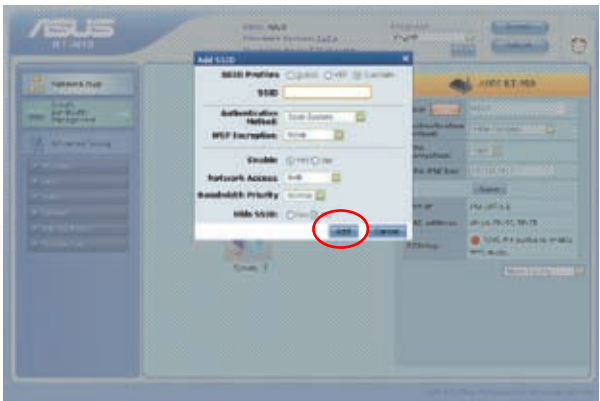

Managing bandwidth with EzQoS



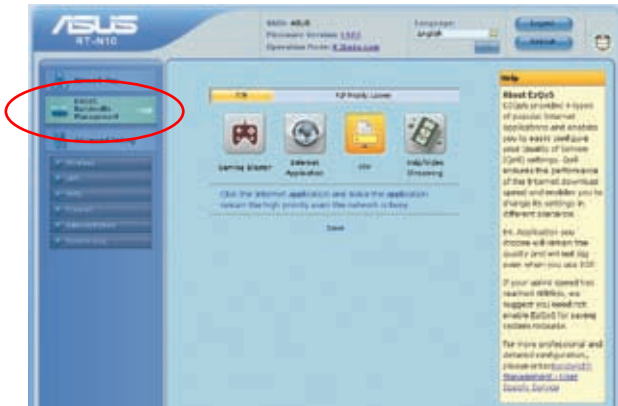

EzQoS Bandwidth Management enables you to set the bandwidth priority and manage the network traffic.

To set up the bandwidth priority:

1. Click **EzQoS Bandwidth Management** from the navigation menu at the left side of your screen.



2. Click each of these four applications to set the bandwidth priority:

Icon	Description
	Gaming Blaster The router handles gaming traffic at first priority.
	Internet Application The router handles the e-mail, web browsing and other Internet applications traffic at first priority.
	FTP The router handles at first priority the traffic of downloading/uploading data to/from the FTP server.
	Voip/Video Streaming The router handles the audio/video traffic at first priority.

3. Click **Save** to save the configuration settings.

Upgrading the firmware



Note: Download the latest firmware from the ASUS website at <http://www.asus.com>.

To upgrade the firmware:

1. Click **Advanced Setting** from the navigation menu at the left side of your screen.



2. Under the **Administration** menu, click **Firmware Upgrade**.
3. In the **New Firmware File** field, click **Browse** to locate the new firmware on your computer.
4. Click **Upload**. The uploading process takes about three minutes.



Note: If the upgrade process fails, use the Firmware Restoration utility to restore the system. For details on this utility, refer to the section **Firmware Restoration** in Chapter 5 of this user manual.

Restoring/Saving/Uploading settings

To restore/save/upload the settings:

1. Click **Advanced Setting** from the navigation menu at the left side of your screen.
2. Under the **Administration** menu, click **Restore/Save/Upload Setting**.

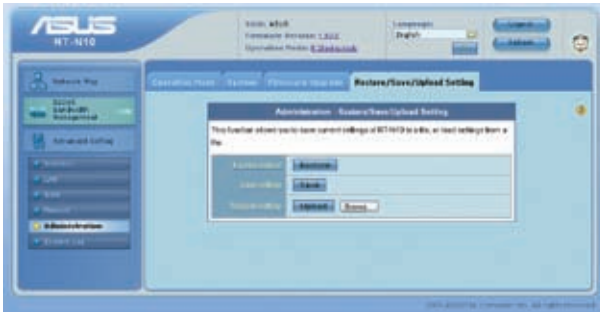

3. Select the tasks that you want to do:
 - To restore to the default factory settings, click **Restore**, and click **OK** in the confirmation message.
 - To save the current system settings, click **Save**, and click **Save** in the file download window to save the system file in your preferred path.
 - To restore previous system settings, click **Browse** to locate the system file that you want to restore, then click **Upload**.

5 Installing the utilities

Installing the utilities

The support CD contains the utilities for configuring the ASUS Wireless Router. To install the ASUS WLAN Utilities in Microsoft® Windows, insert the support CD in the CD drive. If Autorun is disabled, run **setup.exe** from the root directory of the support CD.

To install the utilities:

1. Click **Install...Utilities**.

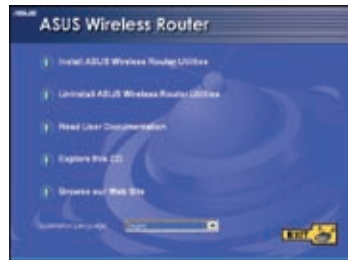

2. Click **Next**.



3. Click **Next** to accept the default destination folder or click **Browse** to specify another path.

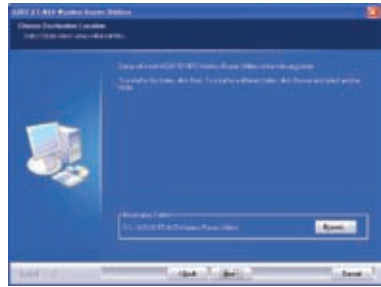

4. Click **Next** to accept the default program folder or enter another name.

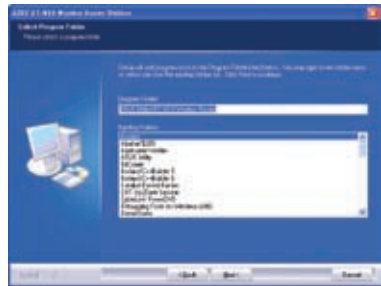

5. Click **Finish** when setup is completed.

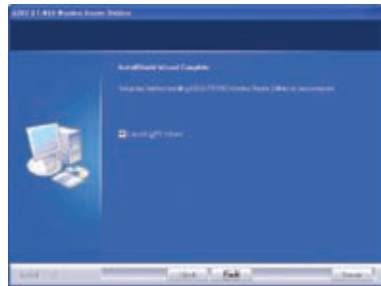

Device Discovery

Device Discovery is an ASUS WLAN utility that detects an ASUS wireless router and enables you to configure the device.

To launch the Device Discovery utility:

From your computer's desktop, click **Start > All Programs > ASUS Utility > RT-N10+ Wireless Router > Device Discovery**.

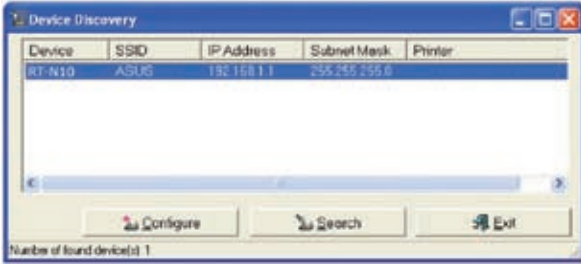

- Click **Configure** to access the web GUI and configure the wireless router.
- Click **Search** to search for ASUS wireless routers within range.
- Click **Exit** to exit the application.

Firmware Restoration

Firmware Restoration is used on an ASUS Wireless Router that failed during its firmware upgrading process. It uploads the firmware that you specify. The process takes about three to four minutes.



Important: Launch the rescue mode before using the Firmware Restoration utility.

To launch the rescue mode and use the Firmware Restoration utility:

1. Unplug the wireless router from the power source.
2. Hold the Restore button at the rear panel and simultaneously re-plug the wireless router into the power source. Release the Restore button when the Power LED at the front panel flashes slowly, which indicates that the wireless router is in the rescue mode.
3. From your computer's desktop, click **Start > All Programs > ASUS Utility > RT-N10+ Wireless Router > Firmware Restoration**.

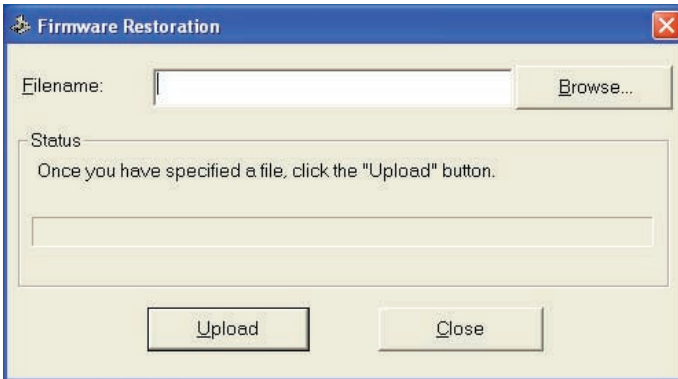

4. Specify a firmware file, then click **Upload**.



Note: This is not a firmware upgrade utility and cannot be used on a working ASUS Wireless Router. Normal firmware upgrades must be done through the web interface. Refer to **Chapter 4: Configuring via the web GUI** for more details.

WPS Wizard

WPS (Wi-Fi Protected Setup) allows you to set up a secure and protected wireless network easily.

Using WPS Wizard



Note:

- Ensure that you use a wireless LAN adapter with WPS function.
- Windows® operating systems and wireless LAN cards/adapters that support WPS:

OS Support	Wireless Adapter Support
Vista 32/64	Intel wireless LAN card
	ASUS 167gv2 driver v3.0.6.0 or later
	ASUS 160N/130N driver v2.0.0.0 or later
XP SP2	Intel wireless LAN card
	ASUS 167gv2 driver v1.2.2.0 or later
	ASUS 160N/130N driver v1.0.4.0 or later
XP SP1 and 2000	ASUS LAN card with ASUS WLAN Utility
	ASUS 167gv2 driver v1.2.2.0 or later
	ASUS 160N/130N driver v1.0.4.0 or later

To use WPS Wizard:

1. Follow the onscreen instructions to set up your hardware. When done, click **Next**.



Note: Use the WPS Wizard with one wireless client at a time. If the wireless client cannot discover the wireless router, shorten the distance between the client and the router.

2. Press the WPS button on your router.

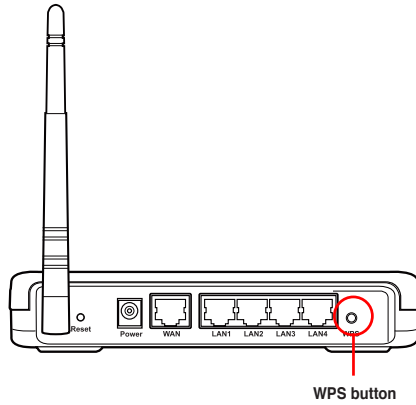

3. On the WPS Wizard, click **Next** to continue.



Notes:

- When running WPS, the Internet connection pauses briefly then reestablishes the connection.
- If the WPS button is pushed without running the WPS Wizard, the PWR indicator flashes and Internet connection pauses briefly and then reestablishes the connection.

4. Key in desired network name or SSID (service set identifier). When done, click **Next**.

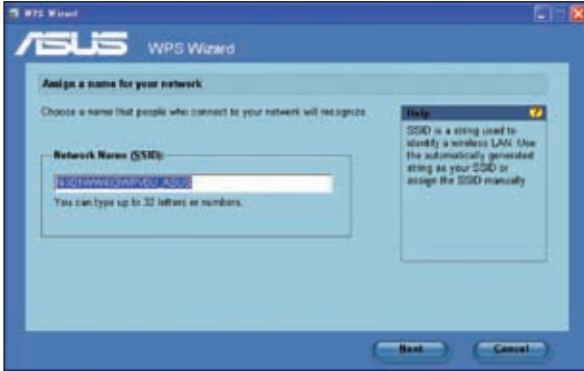

5. Create and key in a passphrase consisting of 8-63 characters or use the automatically generated passphrase then click **Next**.
A passphrase is a sentence, phrase, or sequence of alpha-numeric characters used to generate a security key.

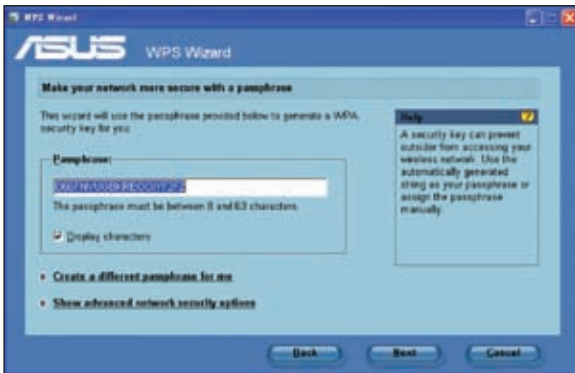

- When finished, click **Save or print settings** for future reference or **Save settings to a USB flash drive** to add other devices to the network. Click **Next** to connect to the Internet.



Note: For more details on adding devices to the network using a USB flash drive, refer to the section **Adding network devices using a USB flash drive** on the next page.

- You have connected to the wireless router. If you want to configure the Internet settings, click **Setup**. Click **Finish** to close the WPS Wizard.

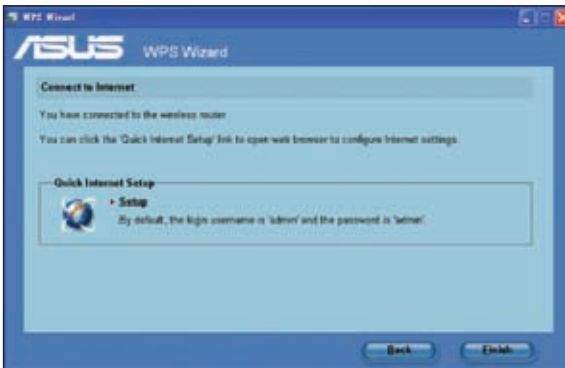

Adding network devices using a USB flash drive

With the WPS utility, you can add devices to your network using a USB flash drive.

To add network devices using a USB flash drive:

1. In the WPS Wizard, click **Save settings to a USB flash drive**.



2. Insert a USB flash drive into your computer's USB port, then select the drive from the dropdown list. When done, click **Next**.



- Unplug the USB flash drive from your computer then insert it to the other computer that you want to add to your wireless network.

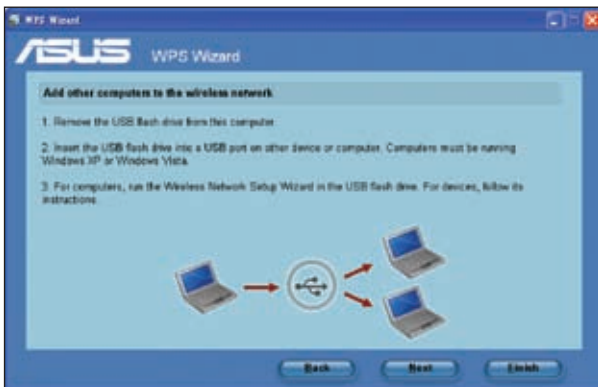

- Locate **SetupWireless.exe** from the USB drive, and double-click to run it. Click **Yes** to add the computer to the wireless network.

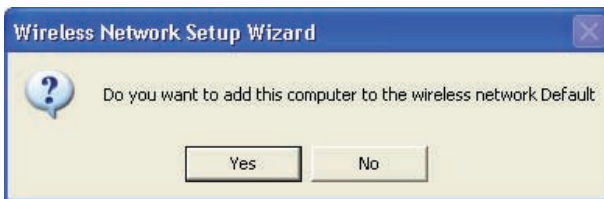

- Click **OK** to exit the **Wireless Network Setup Wizard**.



Troubleshooting 6

Troubleshooting

This troubleshooting guide provides solutions to some common problems that you may encounter while installing or using the ASUS Wireless Router. These problems require simple troubleshooting that you can perform by yourself. Contact the ASUS Technical Support if you encounter problems not mentioned in this chapter.

Problem	Action
I cannot access the web GUI for configuring the router.	<ol style="list-style-type: none">1. Launch a web browser, then click Tools > Internet Options...2. Under Temporary Internet files, click Delete Cookies... and Delete Files...3. Disable the proxy settings of the web browser.
The client cannot establish a wireless connection with the router.	<p>Out of Range:</p> <ul style="list-style-type: none">• Put the router closer to the wireless client.• Try to change the channel settings. <p>Authentication:</p> <ul style="list-style-type: none">• Use wired connection to connect to the router.• Check the wireless security settings.• Press the Restore button at the rear panel for more than five seconds. <p>Cannot find the router:</p> <ul style="list-style-type: none">• Press the Restore button at the rear panel for more than five seconds.• Check the setting in the wireless adapter such as SSID and encryption settings.

Problem	Action
Cannot access the Internet via wireless LAN adapter.	<ul style="list-style-type: none"> • Move the router closer to the wireless client. • Check whether the wireless adapter is connected to the correct wireless router. • Check whether the wireless channel in use conforms to the channels available in your country/area. • Check the encryption settings. • Check if the ADSL or Cable connection is correct. • Retry using another Ethernet cable.
Internet is not accessible.	<ul style="list-style-type: none"> • Check the status indicators on the ADSL modem and the wireless router. • Check if the WAN LED on the wireless router is ON. If the LED is not ON, change the cable and try again.
When ADSL Modem “Link” light is ON (not blinking), this means Internet Access is possible.	<ul style="list-style-type: none"> • Restart your computer. • Refer to the Quick Start Guide of the wireless router and re-configure the settings. • Check if the WAN LED on the wireless router is ON. • Check the wireless encryption settings. • Check if the computer can get the IP address (via both wired network and wireless network). • Ensure that your web browser is configured to use the local LAN, and is not configured to use a proxy server.
If the ADSL “LINK” light blinks continuously or stays off, Internet access is not possible - the Router is unable to establish a connection with the ADSL network.	<ul style="list-style-type: none"> • Ensure that all your cables are all properly connected . • Disconnect the power cord from the ADSL or cable modem, wait a few minutes, then reconnect the cord. • If the ADSL light continues to blink or stays OFF, contact your ADSL service provider.
Network name or encryption keys are forgotten.	<ul style="list-style-type: none"> • Try setting up the wired connection and configuring the wireless encryption again. • Press the Restore button at the rear panel of the wireless router for more than five seconds.

Problem	Action
<p>How to restore the system to its default settings?</p>	<ul style="list-style-type: none"> • Press the Restore button at the rear panel of the wireless router for more than five seconds. • Refer to the section Restoring/Saving/Uploading settings in Chapter 4 of this user manual. <p>The following are the factory default settings:</p> <p>User Name: admin Password: admin Enable DHCP: Yes (if WAN cable is plugged in) IP address: 192.168.1.1 Domain Name: (Blank) Subnet Mask: 255.255.255.0 DNS Server 1: 192.168.1.1 DNS Server 2: (Blank) SSID: ASUS</p>
<p>I cannot use 192.168.1.1 to enter the web GUI.</p>	<p>Check the router's operation mode.</p> <ul style="list-style-type: none"> • In the Router mode, the default IP address is 192.168.1.1. • In the AP mode, use Device Discovery to find the router's IP address.

ASUS DDNS Service

RT-N10+ supports the ASUS DDNS service. When exchanging devices at the service center, if you have registered the ASUS DDNS service and want to keep the original domain name, data transfer is a must. Visit your local service center for more information.



Notes:

- If there is no activity in the domain - such as reconfiguring the router or accessing the registered domain name - within 90 days, the system automatically deletes the registered information.
 - If you encounter any problem or difficulty in using your device, contact the service center.
-

Frequently Asked Questions (FAQs)

1. Will the registered information be lost or registered by others?

If you have not updated the registered information in 90 days, the system automatically deletes the registered information and the domain name may be registered by others.

2. I did not register the ASUS DDNS for the router I bought six months ago. Can I still register it?

Yes, you can still register the ASUS DDNS service for your router. The DDNS service is embedded in your router, so you can register the ASUS DDNS service anytime. Before registering, click **Query** to check if the hostname has been registered or not. If not, the system registers the hostname automatically.

3. I have registered a domain name before and it has been working well until my friends told me that they could not access my domain name.

Check the following:

1. The internet is working well.
2. The DNS server is working well.
3. The last time you updated the domain name.

If there are still problems in accessing your domain name, contact the service center.

4. Can I register two domain names to separately access my http and ftp servers?

No, you cannot. You can only register one domain name for one router. Use port mapping to implement security in the network.

5. After restarting the router, why is it that I see different WAN IPs in MS DOS and in the router configuration page?

This is normal. The interval time between the ISP DNS server and ASUS DDNS results in different WAN IPs in MS DOS and in the router configuration page. Different ISPs may have different interval time for IP updating.

6. Is the ASUS DDNS service free, or is it just a trial version?

The ASUS DDNS service is a free and embedded service in some ASUS routers. Check your ASUS router if it supports the ASUS DDNS service.

Appendices

Notices

Federal Communications Commission Statement

This device complies with Part 15 of the FCC Rules. Operation is subject to the following two conditions:

- This device may not cause harmful interference.
- This device must accept any interference received, including interference that may cause undesired operation.

This equipment has been tested and found to comply with the limits for a class B digital device, pursuant to part 15 of the FCC Rules. These limits are designed to provide reasonable protection against harmful interference in a residential installation.

This equipment generates, uses and can radiate radio frequency energy and, if not installed and used in accordance with the instructions, may cause harmful interference to radio communications. However, there is no guarantee that interference will not occur in a particular installation. If this equipment does cause harmful interference to radio or television reception, which can be determined by turning the equipment off and on, the user is encouraged to try to correct the interference by one or more of the following measures:

- Reorient or relocate the receiving antenna.
- Increase the separation between the equipment and receiver.
- Connect the equipment into an outlet on a circuit different from that to which the receiver is connected.
- Consult the dealer or an experienced radio/TV technician for help.



Caution: Any changes or modifications not expressly approved by the party responsible for compliance could void the user's authority to operate the equipment.

Prohibition of Co-location

This device and its antenna(s) must not be co-located or operating in conjunction with any other antenna or transmitter.

Safety Information

To maintain compliance with FCC's RF exposure guidelines, this equipment should be installed and operated with minimum distance 20cm between the radiator and your body. Use on the supplied antenna.

Declaration of Conformity for R&TTE directive 1999/5/EC

Essential requirements – Article 3

Protection requirements for health and safety – Article 3.1a

Testing for electric safety according to EN 60950-1 has been conducted. These are considered relevant and sufficient.

Protection requirements for electromagnetic compatibility – Article 3.1b

Testing for electromagnetic compatibility according to EN 301 489-1 and EN 301 489-17 has been conducted. These are considered relevant and sufficient.

Effective use of the radio spectrum – Article 3.2

Testing for radio test suites according to EN 300 328- 2 has been conducted. These are considered relevant and sufficient.

CE Mark Warning

This is a Class B product, in a domestic environment, this product may cause radio interference, in which case the user may be required to take adequate measures.

Operation Channels: Ch1~11 for N. America, Ch1~14 Japan, Ch1~13 Europe (ETSI)

IC Warning

The Class B digital apparatus meets all requirements of the Canadian Interference-Causing Equipment Regulation.

Cet appareil numérique de la class B respecte toutes les exigences du Règlement sur le matériel brouilleur du Canada.

GNU General Public License

Licensing information

This product includes copyrighted third-party software licensed under the terms of the GNU General Public License. Please see The GNU General Public License for the exact terms and conditions of this license. We include a copy of the GPL with every CD shipped with our product. All future firmware updates will also be accompanied with their respective source code. Please visit our web site for updated information. Note that we do not offer direct support for the distribution.

GNU GENERAL PUBLIC LICENSE

Version 2, June 1991

Copyright (C) 1989, 1991 Free Software Foundation, Inc.

59 Temple Place, Suite 330, Boston, MA 02111-1307 USA

Everyone is permitted to copy and distribute verbatim copies of this license document, but changing it is not allowed.

Preamble

The licenses for most software are designed to take away your freedom to share and change it. By contrast, the GNU General Public License is intended to guarantee your freedom to share and change free software--to make sure the software is free for all its users. This General Public License applies to most of the Free Software Foundation's software and to any other program whose authors commit to using it. (Some other Free Software Foundation software is covered by the GNU Library General Public License instead.) You can apply it to your programs, too.

When we speak of free software, we are referring to freedom, not price. Our General Public Licenses are designed to make sure that you have the freedom to distribute copies of free software (and charge for this service if you wish), that you receive source code or can get it if you want it, that you can change the software or use pieces of it in new free programs; and that you know you can do these things.

To protect your rights, we need to make restrictions that forbid anyone to deny you these rights or to ask you to surrender the rights. These restrictions translate to certain responsibilities for you if you distribute copies of the software, or if you modify it.

For example, if you distribute copies of such a program, whether gratis or for a fee, you must give the recipients all the rights that you have. You must make sure that they, too, receive or can get the source code. And you must show them these terms so they know their rights.

We protect your rights with two steps: (1) copyright the software, and (2) offer you this license which gives you legal permission to copy, distribute and/or modify the software.

Also, for each author's protection and ours, we want to make certain that everyone understands that there is no warranty for this free software. If the software is modified by someone else and passed on, we want its recipients to know that what they have is not the original, so that any problems introduced by others will not reflect on the original authors' reputations.

Finally, any free program is threatened constantly by software patents. We wish to avoid the danger that redistributors of a free program will individually obtain patent licenses, in effect making the program proprietary. To prevent this, we have made it clear that any patent must be licensed for everyone's free use or not licensed at all. The precise terms and conditions for copying, distribution and modification follow.

Terms & conditions for copying, distribution, & modification

0. This License applies to any program or other work which contains a notice placed by the copyright holder saying it may be distributed under the terms of this General Public License. The “Program”, below, refers to any such program or work, and a “work based on the Program” means either the Program or any derivative work under copyright law: that is to say, a work containing the Program or a portion of it, either verbatim or with modifications and/or translated into another language. (Hereinafter, translation is included without limitation in the term “modification”.) Each licensee is addressed as “you”.

Activities other than copying, distribution and modification are not covered by this License; they are outside its scope. The act of running the Program is not restricted, and the output from the Program is covered only if its contents constitute a work based on the Program (independent of having been made by running the Program). Whether that is true depends on what the Program does.

1. You may copy and distribute verbatim copies of the Program’s source code as you receive it, in any medium, provided that you conspicuously and appropriately publish on each copy an appropriate copyright notice and disclaimer of warranty; keep intact all the notices that refer to this License and to the absence of any warranty; and give any other recipients of the Program a copy of this License along with the Program.

You may charge a fee for the physical act of transferring a copy, and you may at your option offer warranty protection in exchange for a fee.

2. You may modify your copy or copies of the Program or any portion of it, thus forming a work based on the Program, and copy and distribute such modifications or work under the terms of Section 1 above, provided that you also meet all of these conditions:
 - a) You must cause the modified files to carry prominent notices stating that you changed the files and the date of any change.
 - b) You must cause any work that you distribute or publish, that in whole or in part contains or is derived from the Program or any part thereof, to be licensed as a whole at no charge to all third parties under the terms of this License.
 - c) If the modified program normally reads commands interactively when run, you must cause it, when started running for such interactive use in the most ordinary way, to print or display an announcement including an appropriate copyright notice and a notice that there is no warranty (or else, saying that you provide a warranty) and that users may redistribute the program under these conditions, and telling the user how to view a copy of this License. (Exception: if the Program itself is interactive but does not normally print such an announcement, your work based on the Program is not required to print an announcement.)

These requirements apply to the modified work as a whole. If identifiable sections of that work are not derived from the Program, and can be reasonably considered independent and separate works in themselves, then this License, and its terms, do not apply to those sections when you distribute them as separate works. But when you distribute the same sections as part of a whole which is a work based on the Program, the distribution of the whole must be on the terms of this License, whose permissions for other licensees extend to the entire whole, and thus to each and every part regardless of who wrote it.

Thus, it is not the intent of this section to claim rights or contest your rights to work written entirely by you; rather, the intent is to exercise the right to control the distribution of derivative or collective works based on the Program.

In addition, mere aggregation of another work not based on the Program with the Program (or with a work based on the Program) on a volume of a storage or distribution medium does not bring the other work under the scope of this License.

3. You may copy and distribute the Program (or a work based on it, under Section 2) in object code or executable form under the terms of Sections 1 and 2 above provided that you also do one of the following:
 - a) Accompany it with the complete corresponding machine-readable source code, which must be distributed under the terms of Sections 1 and 2 above on a medium customarily used for software interchange; or,
 - b) Accompany it with a written offer, valid for at least three years, to give any third party, for a charge no more than your cost of physically performing source distribution, a complete machine-readable copy of the corresponding source code, to be distributed under the terms of Sections 1 and 2 above on a medium customarily used for software interchange; or,
 - c) Accompany it with the information you received as to the offer to distribute corresponding source code. (This alternative is allowed only for noncommercial distribution and only if you received the program in object code or executable form with such an offer, in accord with Subsection b above.)

The source code for a work means the preferred form of the work for making modifications to it. For an executable work, complete source code means all the source code for all modules it contains, plus any associated interface definition files, plus the scripts used to control compilation and installation of the executable. However, as a special exception, the source code distributed need not include anything that is normally distributed (in either source or binary form) with the major components (compiler, kernel, and so on) of the operating system on which the executable runs, unless that component itself accompanies the executable.

If distribution of executable or object code is made by offering access to copy from a designated place, then offering equivalent access to copy the source code from the same place counts as distribution of the source code, even though third parties are not compelled to copy the source along with the object code.

4. You may not copy, modify, sublicense, or distribute the Program except as expressly provided under this License. Any attempt otherwise to copy, modify, sublicense or distribute the Program is void, and will automatically terminate your rights under this License. However, parties who have received copies, or rights, from you under this License will not have their licenses terminated so long as such parties remain in full compliance.
5. You are not required to accept this License, since you have not signed it. However, nothing else grants you permission to modify or distribute the Program or its derivative works. These actions are prohibited by law if you do not accept this License. Therefore, by modifying or distributing the Program (or any work based on the Program), you indicate your acceptance of this License to do so, and all its terms and conditions for copying, distributing or modifying the Program or works based on it.
6. Each time you redistribute the Program (or any work based on the Program), the recipient automatically receives a license from the original licensor to copy, distribute or modify the Program subject to these terms and conditions. You may not impose any further restrictions on the recipients' exercise of the rights granted herein. You are not responsible for enforcing compliance by third parties to this License.
7. If, as a consequence of a court judgment or allegation of patent infringement or for any other reason (not limited to patent issues), conditions are imposed on you (whether by court order, agreement or otherwise) that contradict the conditions of this License, they do not excuse you from the conditions of this License. If you cannot distribute so as to satisfy simultaneously your obligations under this License and any other pertinent obligations, then as a consequence you may not distribute the Program at all. For example, if a patent license would not permit royalty-free redistribution of the Program by all those who receive copies directly or indirectly through you, then the only way you could satisfy both it and this License would be to refrain entirely from distribution of the Program.

If any portion of this section is held invalid or unenforceable under any particular circumstance, the balance of the section is intended to apply and the section as a whole is intended to apply in other circumstances.

It is not the purpose of this section to induce you to infringe any patents or other property right claims or to contest validity of any such claims; this section has the sole purpose of protecting the integrity of the free software distribution system, which is implemented by public license practices. Many people have made generous contributions to the wide range of software distributed through that system in reliance on consistent application of that system; it is up to the author/donor to decide if he or she is willing to distribute software through any other system and a licensee cannot impose that choice.

This section is intended to make thoroughly clear what is believed to be a consequence of the rest of this License.

8. If the distribution and/or use of the Program is restricted in certain countries either by patents or by copyrighted interfaces, the original copyright holder who places the Program under this License may add an explicit geographical distribution limitation excluding those countries, so that distribution is permitted only in or among countries not thus excluded. In such case, this License incorporates the limitation as if written in the body of this License.
9. The Free Software Foundation may publish revised and/or new versions of the General Public License from time to time. Such new versions will be similar in spirit to the present version, but may differ in detail to address new problems or concerns.

Each version is given a distinguishing version number. If the Program specifies a version number of this License which applies to it and “any later version”, you have the option of following the terms and conditions either of that version or of any later version published by the Free Software Foundation. If the Program does not specify a version number of this License, you may choose any version ever published by the Free Software Foundation.

10. If you wish to incorporate parts of the Program into other free programs whose distribution conditions are different, write to the author to ask for permission. For software which is copyrighted by the Free Software Foundation, write to the Free Software Foundation; we sometimes make exceptions for this. Our decision will be guided by the two goals of preserving the free status of all derivatives of our free software and of promoting the sharing and reuse of software generally.

NO WARRANTY

11. BECAUSE THE PROGRAM IS LICENSED FREE OF CHARGE, THERE IS NO WARRANTY FOR THE PROGRAM, TO THE EXTENT PERMITTED BY APPLICABLE LAW. EXCEPT WHEN OTHERWISE STATED IN WRITING THE COPYRIGHT HOLDERS AND/OR OTHER PARTIES PROVIDE THE PROGRAM “AS IS” WITHOUT WARRANTY OF ANY KIND, EITHER EXPRESSED OR IMPLIED, INCLUDING, BUT NOT LIMITED TO, THE IMPLIED WARRANTIES OF MERCHANTABILITY AND FITNESS FOR A PARTICULAR PURPOSE. THE ENTIRE RISK AS TO THE QUALITY AND PERFORMANCE OF THE PROGRAM IS WITH YOU. SHOULD THE PROGRAM PROVE DEFECTIVE, YOU ASSUME THE COST OF ALL NECESSARY SERVICING, REPAIR OR CORRECTION.

12 IN NO EVENT UNLESS REQUIRED BY APPLICABLE LAW OR AGREED TO IN WRITING WILL ANY COPYRIGHT HOLDER, OR ANY OTHER PARTY WHO MAY MODIFY AND/OR REDISTRIBUTE THE PROGRAM AS PERMITTED ABOVE, BE LIABLE TO YOU FOR DAMAGES, INCLUDING ANY GENERAL, SPECIAL, INCIDENTAL OR CONSEQUENTIAL DAMAGES ARISING OUT OF THE USE OR INABILITY TO USE THE PROGRAM (INCLUDING BUT NOT LIMITED TO LOSS OF DATA OR DATA BEING RENDERED INACCURATE OR LOSSES SUSTAINED BY YOU OR THIRD PARTIES OR A FAILURE OF THE PROGRAM TO OPERATE WITH ANY OTHER PROGRAMS), EVEN IF SUCH HOLDER OR OTHER PARTY HAS BEEN ADVISED OF THE POSSIBILITY OF SUCH DAMAGES.

END OF TERMS AND CONDITIONS

DGT Warning

經型式認證合格之低功率射頻電機，非經許可，公司、商號或使用者均不得擅自變更頻率、加大功率或變更原設計之特性及功能。

低功率射頻電機之使用不得影響飛航安全及干擾合法通信；經發現有干擾現象時，應立即停用，並改善至無干擾時方得繼續使用。

前項合法通信，指依電信法規定作業之無線電通信。

低功率射頻電機須忍受合法通信或工業、科學及醫療用電波輻射性電機設備之干擾。

REACH

Complying with the REACH (Registration, Evaluation, Authorisation, and Restriction of Chemicals) regulatory framework, we published the chemical substances in our products at ASUS REACH website at <http://green.asus.com/english/REACH.htm>.

Safety Warning

SAFE TEMP: This wireless router should be only used in environments with ambient temperatures between 5°C(41°F) and 40°C(104°F).

DO NOT expose to or use near liquids, rain, or moisture. DO NOT use the modem during electrical storms.

ASUS Contact Information

ASUSTeK COMPUTER INC. (Asia Pacific)

Address 15 Li-Te Road, Peitou, Taipei, Taiwan 11259
Website www.asus.com.tw

Technical Support

Telephone +886228943447
Support Fax +886228907698
Online support support.asus.com

ASUS COMPUTER INTERNATIONAL (America)

Address 800 Corporate Way, Fremont, CA 94539, USA
Telephone +15029550883
Fax +15029338713
Website usa.asus.com
Online support support.asus.com

ASUS COMPUTER GmbH (Germany and Austria)

Address Harkort Str. 21-23, D-40880 Ratingen, Germany
Fax +492102959911
Website www.asus.de
Online contact www.asus.de/sales

Technical Support

Telephone (Component) +491805010923*
Telephone (System/Notebook/Eee/LCD) +491805010920*
Fax +492102959911
Online support support.asus.com

* EUR 0.14/minute from a German fixed landline; EUR 0.42/minute from a mobile phone.

Manufacturer:	ASUSTeK Computer Inc. Tel: +886-2-2894-3447 Address: No. 150, LI-TE RD., PEITOU, TAIPEI 112, TAIWAN
Authorised representative in Europe:	ASUS Computer GmbH Address: HARKORT STR. 21-23, 40880 RATINGEN, GERMANY
Authorised distributors in Turkey:	BOGAZICI BIL GISAYAR SAN. VE TIC. A.S. Tel: +90 212 3311000 Address: AYAZAGA MAH. KEMERBURGAZ CAD. NO.10 AYAZAGA/ISTANBUL
	INDEX BILGISAYAR SISTEMLERI MUHENDISLIK SAN. VE TIC. A.S. Tel: +90 212 3312121 Address: AYAZAGA MAH. CENDERE YOLU NO.9 AYAZAGA/ISTANBUL

EEE Yönetmeliğine Uygundur.