

Wireless Outdoor AP/CB



User Manual

Version : 1.0

Table of Contents

| | |
|--|-----------|
| 1 PRODUCT OVERVIEW | 5 |
| 1.1 FEATURE..... | 5 |
| 1.2 BENEFITS..... | 7 |
| 1.3 PACKAGE CONTENTS | 8 |
| 1.3 SYSTEM REQUIREMENT | 8 |
| 2 ENH200 MULTI-FUNCTION INSTRUCTION GUIDE | 9 |
| 2.1 ACCESS POINT | 9 |
| 2.2 ACCESS POINT WITH WDS FUNCTION..... | 9 |
| 2.3 CLIENT BRIDGE | 10 |
| 2.4 WDS BRIDGE..... | 10 |
| 2.7 CLIENT ROUTER | 11 |
| 3 COMPUTER CONFIGURATION INSTRUCTION..... | 12 |
| 3.1 ASSIGN A STATIC IP..... | 12 |
| 3.2 LOGGING METHOD..... | 13 |
| 4 STATUS | 14 |
| 4.1 SAVE/LOAD..... | 14 |
| 4.2 MAIN | 15 |
| 4.3 WIRELESS CLIENT LIST..... | 16 |
| 4.4 SYSTEM LOG | 17 |
| 4.5 CONNECTION STATUS | 18 |
| 4.6 DHCP CLIENT TABLE | 19 |
| 5 SYSTEM | 20 |
| 5.1 SWITCHING OPERATION MODE | 20 |
| 6 WIRELESS CONFIGURATION | 22 |
| 6.1 WIRELESS SETTINGS | 22 |
| 6.1.1 Access Point Mode | 22 |
| 6.1.2 Client Bridge Mode | 25 |
| 6.1.3 WDS Bridge Mode..... | 27 |
| 6.1.4 Client Router Mode | 29 |
| 6.2 WIRELESS SECURITY SETTINGS | 31 |
| 6.2.1 WEP..... | 31 |
| 6.2.2 WPA-PSK | 32 |
| 6.2.3 WPA2-PSK | 33 |
| 6.2.4 WPA-PSK Mixed..... | 34 |
| 6.2.5 WPA | 35 |
| 6.2.6 WPA2 | 36 |
| 6.2.7 WPA Mixed..... | 37 |

| | |
|---|-----------|
| 6.4 WIRELESS ADVANCED SETTINGS | 38 |
| 6.5 WIRELESS MAC FILTER | 40 |
| 6.6 WDS LINK SETTINGS | 41 |
| 7 LAN SETUP | 42 |
| 7.1 IP SETTINGS | 42 |
| 7.2 SPANNING TREE SETTINGS | 43 |
| 8 ROUTER SETTINGS | 44 |
| 8.1 WAN SETTINGS | 44 |
| 8.1.1 Static IP | 44 |
| 8.1.2 DHCP (Dynamic IP) | 46 |
| 8.1.3 PPPoE (Point-to-Point Protocol over Ethernet) | 48 |
| 8.1.4 PPTP (Point-to-Point Tunneling Protocol) | 50 |
| 8.2 LAN SETTINGS (ROUTER MODE) | 52 |
| 8.3 VPN PASS THROUGH | 53 |
| 8.4 PORT FORWARDING | 54 |
| 8.5 DMZ | 55 |
| 9 MANAGEMENT SETTINGS | 56 |
| 9.1 ADMINISTRATION | 56 |
| 9.2 MANAGEMENT VLAN | 58 |
| 9.3 SNMP SETTINGS | 59 |
| 9.4 BACKUP/RESTORE SETTINGS | 60 |
| 9.5 FIRMWARE UPGRADE | 61 |
| 9.6 TIME SETTINGS | 62 |
| 9.7 LOG | 63 |
| 9.8 DIAGNOSTICS | 64 |
| 10 NETWORK CONFIGURATION EXAMPLE | 65 |
| 10.1 ACCESS POINT | 65 |
| 10.2 CLIENT BRIDGE MODE | 66 |
| 10.3 WDS BRIDGE MODE | 67 |
| 10.4 CLIENT ROUTER | 68 |
| EUROPE – EU DECLARATION OF CONFORMITY | 71 |



About This Document

This document is written by EnGenius Inc. EnGenius Inc. has rights to change any of this document without notice and all rights reserved. This document can only be used for guiding the configuration setup of EnGenius products.

This document is to demonstrate the EnGenius ENH200 Wireless Access Point & Client Bridge. Please read the document carefully before setup the ENH200. If the damage is caused by the inappropriate behaviors, the repair will not be included in the warranty.

Formats

This document uses following symbols to indicate and highlight special message.

| | |
|---|---|
|  | Caution: This symbol represents the Vital message and it could be harmful for the device or settings. |
|  | Note: This symbol represents the important message for the settings. |
|  | Tip: This symbol represents the alternative choice that can save time or resources. |

Before you start

The following equipments are essential to setup the ENH200:

1. One Computer/Notebook and internet accessible.
2. Two Ethernet Cables.
3. One EnGenius device – ENH200.

 The equipments listed above are only for setup the ENH200, you will need more equipment to connect the internet and it is depend on your internet network structure. You may refer to the chapter 2 for more information.

1 Product Overview

Thank you for using ENH200. It is a powerful, enhanced, enterprise scale product with 4+1 multi-functions Access Point, Access Point with WDS function, Client Bridge, WDS Bridge, and Client Router.

ENH200 uses the latest wireless technology 802.11n standard. It has faster transmit/receive wireless speed. ENH200 gives you a great advantage to save your time and cost to expend your network. It is also compatible with 802.11b and 802.11g.

ENH200 is easily to install almost anywhere with Power over Ethernet for quick indoor installation and regular Power by Adapter. ENH200 can manage power level control, Narrow bandwidth selection, Traffic shaping and Real-time RSSI indicator. ENH200 is fully support of security encryption including Wi-Fi Protected Access (WPA-PSK/WPA2-PSK), 64/128/152-bit WEP Encryption and IEEE 802.1x with RADIUS Accounting.

1.1 Feature

The following list describes the design of the ENH200 made possible through the power and flexibility of wireless LANs:

a) Difficult-to-wire environments

There are many situations where wires cannot be laid easily. Historic buildings, older buildings, open areas and across busy streets make the installation of LANs either impossible or very expensive.

b) Temporary workgroups

Consider situations in parks, athletic arenas, exhibition centers, disaster-recovery, temporary offices and construction sites where one wants a temporary WLAN established and removed.

c) The ability to access real-time information

Doctors/nurses, point-of-sale employees, and warehouse workers can access real-time information while dealing with patients, serving customers and processing information.

d) Frequently changed environments

Show rooms, meeting rooms, retail stores, and manufacturing sites where frequently rearrange the workplace.

e) Wireless extensions to Ethernet networks

Network managers in dynamic environments can minimize the overhead caused by moves, extensions to networks, and other changes with wireless LANs.

f) Wired LAN backup

Network managers implement wireless LANs to provide backup for mission-critical applications running on wired networks.

g) Training/Educational facilities

Training sites at corporations and students at universities use wireless connectivity to ease access to information, information exchanges, and learning.

Benefits

| | |
|--|---|
| High Speed Data Rate Up to 150Mbps | Capable of handling heavy data payloads such as MPEG video streaming |
| High Output Power up to 26 dBm | Extended excellent Range and Coverage |
| IEEE 802.11b/g/n Compliant | Fully Interoperable with IEEE 802.11b/IEEE 802.11g/IEEE 802.11n compliant devices |
| 4+1 Multi-Function | Users can use different mode in various environment |
| Point-to-point, Point-to-multipoint Wireless Connectivity | Let users transfer data between two buildings or multiple buildings |
| Channel Bandwidth Selection | Using different bandwidth to reach varied distance |
| Support RSSI Indicator (CB mode) | Users can select the best signal to connect with AP easily |
| Power-over-Ethernet | Flexible Access Point locations and cost savings. ENH200 must uses the adapter provided in the package. |
| Support Multi-SSID function (4 SSID) in AP mode | Allow clients to access different networks through a single access point and assign different policies and functions for each SSID by manager |
| WPA2/WPA/ WEP/ IEEE 802.1x support | Fully support all types of security types. |
| MAC address filtering in AP mode | Ensures secure network connection |
| PPPoE/PPTP function support (AP Router/CR mode) | Easy to access internet via ISP service authentication |
| SNMP Remote Configuration Management | Help administrators to remotely configure or manage the Access Point easily. |
| QoS (WMM) support | Enhance user performance and density |

1.2 Benefits

| | |
|-----------------------------|--|
| Access Point Mode | Use this feature to setup the access point's configuration information. It has support adjusting transmit power and channel. Client can access the network with different regulatory settings and automatically change to the local regulations. |
| Client Bridge Mode | Use this feature to connect to an Access Point and enjoy the great speed of surfing internet. |
| WDS Mode | Use this feature to link multiple APs in a network, All clients associated with any APs can communicate each other like an ad-hoc mode. |
| Client Router Mode | This feature functions completely opposite but similarly with AP Router Mode. Client Router connected to an AP wirelessly and transmit internet connection protocol through AP to access the internet. |
| Multiple SSIDs | ENH200 supports up to 4 SSIDs on your access point. The following options can be set to each SS to each SSID: <ul style="list-style-type: none">- SSID for public or private network- Authentication is fully supported- VLAN identifier- Radius accounting identifier- Profile isolation for infrastructure network |
| VLAN | Specify a VLAN number for each SSID to separate the services among clients. |
| QoS | Use this feature to limit the incoming or outgoing throughput. |
| Wi-Fi Protect Access | Wi-Fi Protect Access is a standard-based interoperable security enhancement that increases the level of data protection and access control for existing and future wireless LAN system. It is compatible with IEEE 802.11i standard WPA leverages TKIP and 802.1X for authenticated key management. |

1.3 Package Contents

Open the package carefully, and make sure that none of the items listed below are missing. Do not discard the packing materials, in case of return; the unit must be shipped in its original package.

- 1* Wireless Access Point / Client Bridge (ENH200)
- 1* 24V/0.6A Power Adapter
- 1* QIG
- 1* CD (User Manual)



Using other Power Adapter than the one included with ENH200 may cause damage of the device.

1.3 System Requirement

The following conditions are the minimum system requirement.

- A computer with an Ethernet interface and operating under Windows XP, Vista, 7 or Linux.
- Internet Browser that supports HTTP and JavaScript.

2 ENH200 Multi-Function Instruction Guide

2.1 Access Point

In the Access Point Mode, ENH200 function like a central connection for any stations or clients that support IEEE 802.11b/g/n network. Stations and Client must configure the same SSID and Security Password to associate within the range. ENH200 supports 4 different SSIDs to separate different clients at the same time.

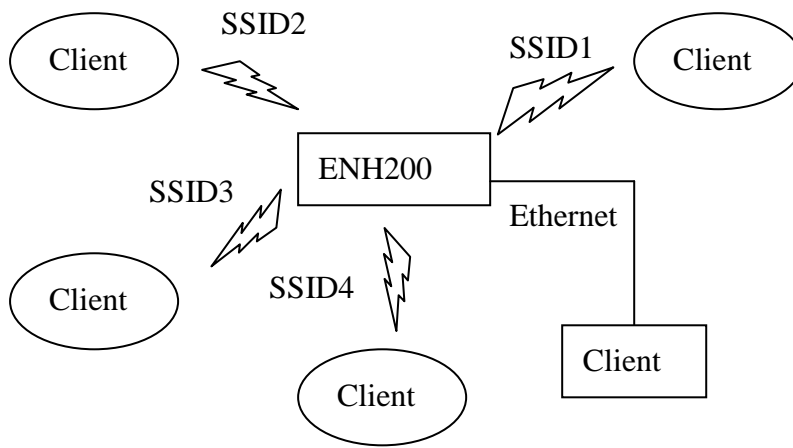

2.2 Access Point with WDS Function

ENH200 also supports WDS function in Access Point Mode without losing AP's capabilities. Configure others Access Point's Wireless MAC Address in both Access Point devices to enlarge the wireless area by enabling WDS Link Settings. WDS function can support up to 8 different AP's MAC addresses.

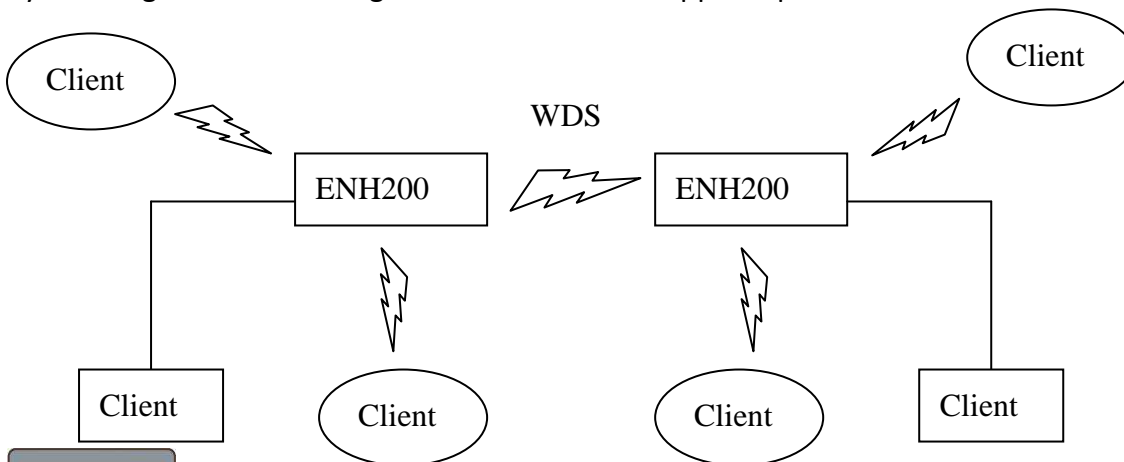

Not every Access Point device has support WDS in Access Point Mode. It is recommended using ENH200 if you would like to use this service.

2.3 Client Bridge

In the Client Bridge Mode, the ENH200 function likes a wireless client connecting to an Access Point wirelessly and surf internet whenever you want. Using Site Survey to scan all the Access Point within the range and configure its SSID and Security Password to associate with it. Connect you station to the LAN port of the ENH200 via Ethernet.

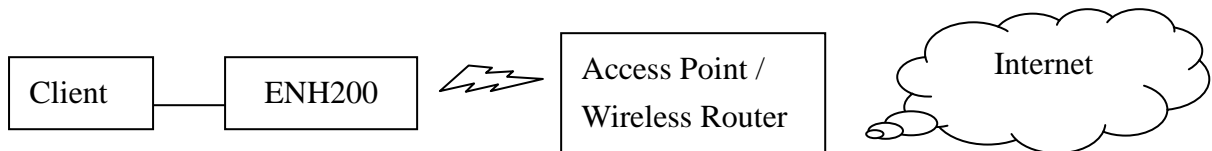

2.4 WDS Bridge

In the WDS Bridge Mode, the ENH200 can wirelessly connect different LANs by just simply configure each other's MAC Address and Security Settings. This mode is used when two wired LANs locate in small distance and want to communicate each other. The best solution is using ENH200 wirelessly connect two wired LANs. WDS Bridge Mode can establish 16 WDS links, the network diagram is like a Star.

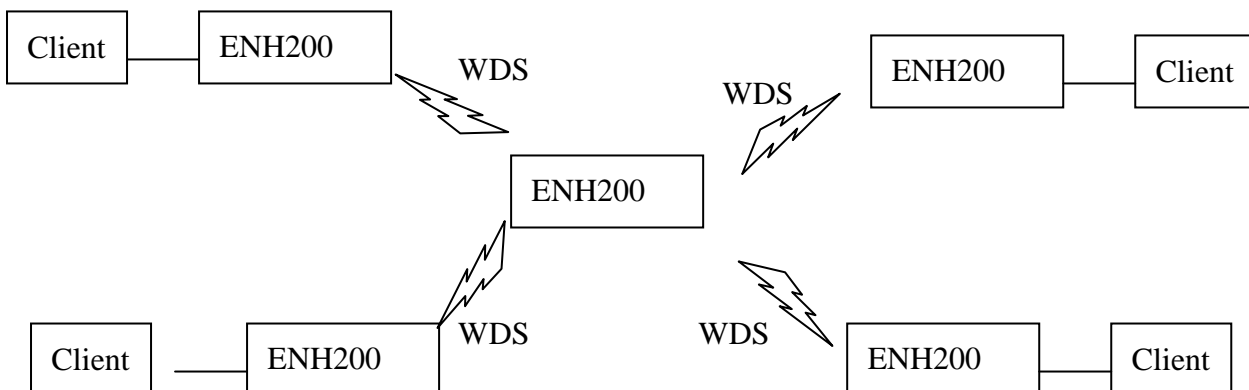

CAUTION WDS Bridge Mode is unlike Access Point. APs linked by WDS are using the same frequency channel, more APs connected together may lower throughput. Please be aware to avoid loop connection diagram, otherwise enable Spanning Tree Function.

2.7 Client Router

In the Client Router Mode, the ENH200 has DHCP Server build inside that allows many LANs automatically generate an IP address to share the same Internet. Connect an AP/WISP Wirelessly and connect to LANs via wired. Client Router Mode is act completely opposite to the AP Router Mode.

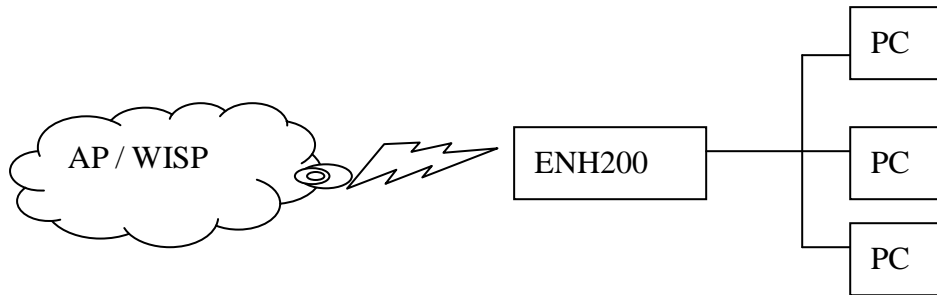

3 Computer Configuration Instruction

The default operating mode is Client Bridge. Client Bridge will not assign an IP address to the computer/notebook. Therefore, follow the steps to assign an IP address to your Ethernet card.

3.1 Assign a Static IP

In order to configure ENH200, please follow the instruction below:

1. In the **Control Panel**, double click **Network Connections** and then double click on the connection of your **Network Interface Card (NIC)**. You will then see the following screen.

2. Select **Internet Protocol (TCP/IP)** and then click on the **Properties** button. This will allow you to configure the TCP/IP settings of your PC/Notebook

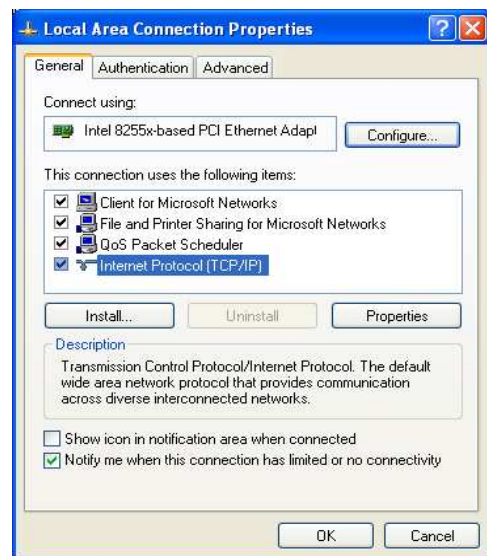

3. Select **Use the following IP address** radio button and then enter the IP address and subnet mask. Ensure that the IP address and subnet mask are on the same subnet as the device.

4. Click on the **OK** button to close this window, and then close LAN properties window.

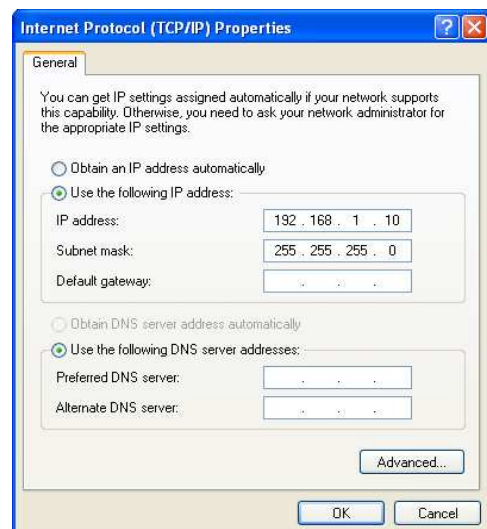

NOTE

IP Address entered in the TCP/IP Properties needs to be at the same subnet of the ENH200 IP Address. For example: ENH200's default IP Address is **192.168.1.1** so the IP Address in the TCP/IP settings could be **192.168.1.10**.

3.2 Logging Method

After complete the IP settings from last section, you can now access the web-based configuration menu.

1. Open web browser



2. Enter IP **192.168.1.1** into you address filter.

Caution: If you have changed the ENH200 LAN IP address, make sure you enter the correct IP Address.



3. After connected to the ENH200 successfully, browser will pop out a Windows Security window. Please enter the correct **Username** and **Password**.

4. The default Username and Password are both **admin**.



If you have changed the Username and Password, please enter your own Username and Password.

4 Status

Status section is on the navigation drop-down menu. You will then see three options: Main, Wireless Client List, System Log, WDS Link Status, Connection Status, and DHCP Client Table. Each option is described in detail below.

4.1 Save/Load

This page allows viewing the modified changes. The changes show in the Unsaved changes list table. You can decide to cancel all the changes or to compile to the new setting.

Save/Reload

[Home](#)[Reset](#)

Unsaved changes list

```
network.sys.opmode=ap'  
wireless.wifi0.countryName=N/A
```

Caution: Network Setting changed, redirect IP to 192.168.1.1

[Save & Apply](#)[Revert](#)

NOTE

You cannot cancel the specific settings. You can only compile all the settings or revert to the previous settings.

4.2 Main

Click on the **Main** link under the **Status** drop-down menu or click **Home** from the top-right of the webpage. The status that is displayed corresponds with the operating mode that is selected. Information such as operating mode, system up time, firmware version, serial number, kernel version and application version are displayed in the 'System' section. LAN IP address, subnet mask, and MAC address are displayed in the 'LAN' section. In the 'Wireless section, the frequency, channel is displayed. Since this device supports multiple-SSIDs, the details of each SSID, such as ESSID and its security settings are displayed.

Main

[Home](#)[Reset](#)

System Information

| | |
|--------------------------|---------------------------------|
| Device Name | ENH200 |
| Ethernet WAN MAC Address | 00:02:6F:34:56:78 |
| Ethernet LAN MAC Address | 00:02:6F:34:56:78 |
| Wireless MAC Address | 00:02:6F:34:56:78 |
| Country | N/A |
| Current Time | Tue Oct 19 11:40:42 UTC 2010 |
| Firmware Version | 0.9.0.1 build-101019 (5b39146d) |
| Management VLAN ID | Untagged |

LAN Settings

| | |
|-----------------|---------------|
| IP Address | 192.168.1.1 |
| Subnet Mask | 255.255.255.0 |
| Default Gateway | 192.168.1.1 |
| Primary DNS | 0.0.0.0 |
| Secondary DNS | 0.0.0.0 |
| DHCP Client | Disabled |

Current Wireless Settings

| | |
|---|------------------------|
| Operation Mode | Access Point |
| Wireless Mode | IEEE 802.11b/g/n mixed |
| Channel Bandwidth | 40 MHz |
| Frequency/Channel | 2.442 GHz (Channel 7) |
| Profile Isolation | No |
| Profile Settings (SSID/Security/VID) | 1 EnGenius1/None/1 |
| | 2 N/A |
| | 3 N/A |
| | 4 N/A |
| Spanning Tree Protocol | Disabled |
| Distance | 3 Km |

4.3 Wireless Client List

Click on the **Wireless Client List** link under the **Status** drop-down menu. This page displays the list of Clients that are associated to the ENH200.

The MAC addresses and signal strength for each client is displayed. Click on the **Refresh** button to refresh the client list

Client List

[Home](#)[Reset](#)

| # | MAC Address | RSSI(dBm) |
|---|-------------|-----------|
|---|-------------|-----------|

4.4 System Log

Click on the **System Log** link under the **Status** drop-down menu. The device automatically logs (records) events of possible interest in its internal memory. If there is not enough internal memory for all events, logs of older events are deleted, but logs of the latest events are retained.

System Log

[Home](#)[Reset](#)

Show log type **All** ▼

```
Oct 19 10:16:58 (none) user.warn kernel: jffs2_build_filesystem(): erasing
Oct 19 10:16:58 (none) user.info kernel: mini_fo: using storage directory:
Oct 19 10:16:58 (none) user.info kernel: mini_fo: using base directory: /
Oct 19 10:16:34 (none) user.warn kernel: jffs2_scan_eraseblock(): End of f
Oct 19 10:16:34 (none) user.warn kernel: jffs2_build_filesystem(): unlocki
Oct 19 10:16:33 (none) user.warn kernel: ar5416SetSwitchCom, ant switch co
Oct 19 10:16:33 (none) daemon.info dnsmasq[823]: using local addresses onl
Oct 19 10:16:33 (none) daemon.info dnsmasq[823]: using local addresses onl
Oct 19 10:16:33 (none) daemon.info dnsmasq[823]: started, version 2.52 cac
Oct 19 10:16:33 (none) daemon.info dnsmasq[823]: reading /tmp/resolv.conf.
Oct 19 10:16:33 (none) daemon.info dnsmasq[823]: read /etc/hosts - 1 addre
Oct 19 10:16:33 (none) daemon.info dnsmasq[823]: compile time options: IPv
Oct 19 10:16:31 (none) user.info kernel: device ath0 entered promiscuous m
Oct 19 10:16:31 (none) user.info kernel: br-lan: topology change detected,
Oct 19 10:16:31 (none) user.info kernel: br-lan: port 3(ath0) entering lea
Oct 19 10:16:31 (none) user.info kernel: br-lan: port 3(ath0) entering for
Oct 19 10:16:30 (none) user.warn kernel: osif_vap_init : wait for connecti
Oct 19 10:16:30 (none) user.info kernel: device ath0 left promiscuous mode
Oct 19 10:16:30 (none) user.info kernel: br-lan: port 3(ath0) entering dis
Oct 19 10:16:25 (none) user.warn kernel: start running
Oct 19 10:16:25 (none) user.warn kernel: set SIOC80211NWID, 8 characters
Oct 19 10:16:25 (none) user.warn kernel: osif_vap_init : wakeup from wait
```

[Refresh](#)[Clear](#)

4.5 Connection Status

Click on the **Connection Status** link under the **Status** drop-down menu. This page displays the current status of the network, including network type, SSID, BSSID, connection status, wireless mode, current channel, security, data rate, noise level and signal strength.

Wireless

| | |
|---------------------|---------------|
| Network Type | Client Router |
| SSID | EnGenius |
| BSSID | N/A |
| Connection Status | N/A |
| Wireless Mode | N/A |
| Current Channel | N/A |
| Security | N/A |
| Tx Data Rate(Mbps) | N/A |
| Current noise level | N/A |
| Signal strength | N/A |

WAN

| | |
|-------------------|-------------------|
| MAC Address | 00:02:6f:75:9f:a8 |
| Connection Type | Static IP |
| Connection Status | Down |
| IP Address | |
| IP Subnet Mask | 0.0.0.0 |

Refresh

4.6 DHCP Client Table

Click on the **DHCP Client List** link under the **Status** drop-down menu. This page displays the list of Clients that are associated to the ENH200 through DHCP.

The MAC addresses and signal strength for each client is displayed. Click on the **Refresh** button to refresh the client list.

DHCP Client List

[Home](#)[Reset](#)

| MAC addr | IP | Expires |
|----------|----|---------|
|----------|----|---------|

[Refresh](#)

5 System

5.1 Switching Operation Mode

The ENH200 supports 4+1 operation modes: Access Point, Client Bridge, WDS Bridge, and Client Router. In order to switching between the operating modes, please go to System -> Operation mode.

Click **System Properties** under System Section to begin.

System Properties Home Reset

System Properties

| | |
|----------------|---|
| Device Name | ENH200 (1 to 32 characters) |
| Country/Region | United States |
| Operation Mode | <input type="radio"/> Access Point <input checked="" type="radio"/> Client Bridge <input type="radio"/> WDS Bridge <input type="radio"/> Client Router |

Accept Cancel

Device Name: Specify a name for the device. It is not the broadcast SSID. It will be shown in SNMP management.

Country/Region: United States

Operation Mode: Select an operation mode via **Radio Button**.

Click **Accept** to confirm the changes.



Accept does not compile the changes, you must go to Status -> Save/Load to apply the new settings. Please refer to the chapter 4.1 for more detail.



If you would like to use Access Point with WDS Function mode, please select Access Point Mode and

then enable WDS function in the Wireless Network section.

6 Wireless Configuration

This section will guide you through all the wireless settings. Please read the instruction carefully. Inappropriate setting could lower the performance or affect the network structure. Before you continue, please make sure you have chosen the correct operating mode.

6.1 Wireless Settings

This section is the basic wireless settings. Please read the description carefully and check the steps on chapter 10 in case you need more detail information.

6.1.1 Access Point Mode

Wireless Network

[Home](#)[Reset](#)

| | |
|---------------------|---|
| Wireless Mode | 802.11 B/G/N Mixed ▾ |
| Channel HT Mode | 40MHz ▾ |
| Extension Channel | Lower Channel ▾ |
| Channel / Frequency | Ch5-2.432GHz ▾ <input checked="" type="checkbox"/> Auto |
| WDS | <input type="radio"/> Enable <input checked="" type="radio"/> Disable |
| AP Detection | <input type="button" value="Scan"/> |

Current Profiles

| SSID | Security | VID | Enable | Edit |
|-----------|----------|-----|-------------------------------------|-------------------------------------|
| EnGenius1 | None | 1 | <input checked="" type="checkbox"/> | <input type="button" value="Edit"/> |
| EnGenius2 | None | 2 | <input type="checkbox"/> | <input type="button" value="Edit"/> |
| EnGenius3 | None | 3 | <input type="checkbox"/> | <input type="button" value="Edit"/> |
| EnGenius4 | None | 4 | <input type="checkbox"/> | <input type="button" value="Edit"/> |

| | |
|-------------------------|--|
| Profile (SSID)Isolation | <input checked="" type="radio"/> No Isolation <input type="radio"/> Isolate all Profiles (SSIDs) from each other using VLAN (802.1Q) standard |
|-------------------------|--|

| | |
|----------------------------|---|
| Wireless Mode | The wireless mode supports 802.11b/g/n mixed modes. It is compatible with the most common known wireless band. |
| Channel HT Mode | The default channel bandwidth is 40 MHz. The larger channel can provide better transmit quality and speed. |
| Extension Channel | Specify the upper channel or lower channel selection. It may influence the Auto channel function |
| Channel / Frequency | The channel availability is based on the US regulation. |
| Auto | Place a Check mark to enable Auto channel selection. |
| AP Detection | AP Detection can help to select a best channel by scan nearby area. |
| Current Profile | Configure up to four different SSIDs, it can help to divide group of clients to access the network. Press Edit to configure the profile and place a Check to enable extra SSID. |
| Profile Isolation | Restricted Client to communicate with different VID by Selecting the Radio button. |
| Accept / Cancel | Press Accept to confirm the changes or Cancel to return previous settings. |



Accept does not compile the changes, you must go to Status -> Save/Load to apply the new settings. Please refer to the chapter 4.1 for more detail.

SSID Profile

Wireless Setting

| | |
|--------------------|---|
| SSID | EnGenius1 (1 to 32 characters) |
| VLAN ID | 1 (1~4095) |
| Suppressed SSID | <input type="checkbox"/> |
| Station Separation | <input type="radio"/> Enable <input checked="" type="radio"/> Disable |

Wireless Security

| | |
|---------------|------------|
| Security Mode | Disabled ▼ |
|---------------|------------|

| | |
|---------------------------|--|
| SSID | Specify the SSID for current profile. |
| VLAN ID | Specify the VLAN tag for current profile. |
| Suppressed SSID | Place a Check to hide the SSID. Client will not be able to see the broadcast SSID in Site Survey. |
| Station Separation | Select the Radio Button to allow / deny client to communicate each other. |
| Wireless Security | Please refer to the Wireless Security section. |
| Save / Cancel | Press Save to save the changes or Cancel to return previous settings. |

6.1.2 Client Bridge Mode

Wireless Network

[Home](#)[Reset](#)

| | |
|-----------------|---|
| Wireless Mode | 802.11 B/G/N Mixed ▾ |
| SSID | Specify the static SSID : AP SSID <input type="text"/> (1 to 32 characters) Or press the button to search for any available WLAN Service. <input type="button" value="Site Survey"/> |
| Preferred BSSID | <input type="checkbox"/> <input type="text"/> : <input type="text"/> : <input type="text"/> : <input type="text"/> : <input type="text"/> : <input type="text"/> |
| WDS Client | <input type="radio"/> Enable <input checked="" type="radio"/> Disable |

Wireless Security

Changing the wireless security settings may cause this wireless client to associate with a different one. This may temporarily disrupt your configuration session.

| | |
|---------------|------------|
| Security Mode | Disabled ▾ |
|---------------|------------|

| | |
|--------------------------|---|
| Wireless Mode | The wireless mode supports 802.11b/g/n mixed modes. It is compatible with the most common known wireless band. |
| SSID | Specify the SSID if known. SSID text box will be automatically fill in when select an AP in the Site Survey. |
| Site Survey | Using Site Survey to scan nearby APs and then select the AP to establish the connection. |
| Prefer BSSID | Specify the MAC address if known. Prefer BSSID text box will be automatically fill in when select an AP in the Site Survey. |
| WDS Client | Place a Radio button to Enable / Disable WDS Client. |
| Wireless Security | Please refer to the chapter 6.2 for details. |
| Accept / Cancel | Press Accept to confirm the changes or Cancel to return previous settings. |





Accept does not compile the changes, you must go to Status -> Save/Load to apply the new settings. Please refer to the chapter 4.1 for more detail.

Site Survey

2.4GHz Site Survey

:Infrastructure :Ad_hoc

| BSSID | SSID | Channel | Signal | Type | Security | Network Mode |
|-------------------|---------|---------|----------|------|----------|---|
| 00:e0:4c:81:86:21 | DinoNet | 1 | -86 dBm | B | WEP |  |
| 00:13:f7:7c:6f:43 | SMC | 6 | -105 dBm | G | NONE |  |

Refresh

| | |
|--------------------------|---|
| Profile | After Site Survey, webpage will display all nearby area's Access Point. Click the BSSID if you would like to connect with it. |
| Wireless Security | Please refer to the Wireless Security section. |
| Refresh | Press Refresh to scan again. |

NOTE

If the Access Point is suppressed its own SSID, SSID section will be blank, the SSID must be filled in manually.

6.1.3 WDS Bridge Mode

Wireless Network

[Home](#)[Reset](#)

| | |
|---------------------|----------------------|
| Wireless Mode | 802.11 B/G/N Mixed ▾ |
| Channel HT Mode | 40MHz ▾ |
| Extension Channel | Upper Channel ▾ |
| Channel / Frequency | Ch6-2.437GHz ▾ |

[Accept](#)[Cancel](#)

| | |
|----------------------------|--|
| Wireless Mode | The wireless mode supports 802.11b/g/n mixed modes. It is compatible with the most common known wireless band. |
| Channel HT Mode | The default channel bandwidth is 40 MHz. The larger channel can provide better transmit quality and speed. |
| Extension Channel | Specify the upper channel or lower channel selection. It may influence the Auto channel function |
| Channel / Frequency | The channel availability is based on the US regulation. |
| Accept / Cancel | Press Accept to confirm the changes or Cancel to return previous settings. |



Accept does not compile the changes, you must go to Status -> Save/Load to apply the new settings. Please refer to the chapter 4.1 for more detail.

WDS Link Settings

Home

Reset

| ID | MAC Address | Mode |
|----|---|-----------|
| 1 | <input type="text"/> : <input type="text"/> : <input type="text"/> : <input type="text"/> : <input type="text"/> : <input type="text"/> | Disable ▾ |
| 2 | <input type="text"/> : <input type="text"/> : <input type="text"/> : <input type="text"/> : <input type="text"/> : <input type="text"/> | Disable ▾ |
| 3 | <input type="text"/> : <input type="text"/> : <input type="text"/> : <input type="text"/> : <input type="text"/> : <input type="text"/> | Disable ▾ |
| 4 | <input type="text"/> : <input type="text"/> : <input type="text"/> : <input type="text"/> : <input type="text"/> : <input type="text"/> | Disable ▾ |
| 5 | <input type="text"/> : <input type="text"/> : <input type="text"/> : <input type="text"/> : <input type="text"/> : <input type="text"/> | Disable ▾ |
| 6 | <input type="text"/> : <input type="text"/> : <input type="text"/> : <input type="text"/> : <input type="text"/> : <input type="text"/> | Disable ▾ |
| 7 | <input type="text"/> : <input type="text"/> : <input type="text"/> : <input type="text"/> : <input type="text"/> : <input type="text"/> | Disable ▾ |
| 8 | <input type="text"/> : <input type="text"/> : <input type="text"/> : <input type="text"/> : <input type="text"/> : <input type="text"/> | Disable ▾ |

Accept Cancel

| | |
|------------------------|---|
| MAC Address | Enter the Access Point's MAC address that you would like to extend the wireless area into the MAC address filter. |
| Mode | Select Disable or Enable from the drop down list. |
| Accept / Cancel | Press Accept to confirm the changes or Cancel to return previous settings. |



1. Accept does not compile the changes, you must go to Status -> Save/Load to apply the new settings. Please refer to the chapter 4.1 for more detail.
2. The Access Point that you would like to extend the wireless area must enter your Access Point's MAC address. Not all Access Point supports this feature.

6.1.4 Client Router Mode

Wireless Network

[Home](#)[Reset](#)

| | |
|-----------------|---|
| Wireless Mode | 802.11 B/G/N Mixed ▾ |
| SSID | Specify the static SSID : AP SSID <input type="text"/> (1 to 32 characters) Or press the button to search for any available WLAN Service. <input type="button" value="Site Survey"/> |
| Preferred BSSID | <input type="checkbox"/> <input type="text"/> : <input type="text"/> : <input type="text"/> : <input type="text"/> : <input type="text"/> : <input type="text"/> |

Wireless Security

Changing the wireless security settings may cause this wireless client to associate with a different one. This may temporarily disrupt your configuration session.

| | |
|---------------|------------|
| Security Mode | Disabled ▾ |
|---------------|------------|

| | |
|--------------------------|---|
| Wireless Mode | The wireless mode supports 802.11b/g/n mixed modes. It is compatible with the most common known wireless band. |
| SSID | Specify the SSID if known. SSID text box will be automatically fill in when select an AP in the Site Survey. |
| Site Survey | Using Site Survey to scan nearby APs and then select the AP to establish the connection. |
| Prefer BSSID | Specify the MAC address if known. Prefer BSSID text box will be automatically fill in when select an AP in the Site Survey. |
| Wireless Security | Please refer to the chapter 6.2 for details. |
| Accept / Cancel | Press Accept to confirm the changes or Cancel to return previous settings. |





Accept does not compile the changes, you must go to Status -> Save/Load to apply the new settings. Please refer to the chapter 4.1 for more detail.

Site Survey

2.4GHz Site Survey

:Infrastructure :Ad_hoc

| BSSID | SSID | Channel | Signal | Type | Security | Network Mode |
|-------------------|---------|---------|----------|------|----------|---|
| 00:e0:4c:81:86:21 | DinoNet | 1 | -86 dBm | B | WEP |  |
| 00:13:f7:7c:6f:43 | SMC | 6 | -105 dBm | G | NONE |  |

Refresh

| | |
|--------------------------|---|
| Profile | After Site Survey, webpage will display all nearby area's Access Point. Click the BSSID if you would like to connect with it. |
| Wireless Security | Please refer to the Wireless Security section. |
| Refresh | Press Refresh to scan again. |

NOTE

If the Access Point is suppressed its own SSID, SSID section will be blank, the SSID must be filled in manually.

6.2 Wireless Security Settings

Wireless Security Settings section will guide you to the entire Security modes configuration: WEP, WPA-PSK, WPA2-PSK, WPA-PSK Mixed, WPA, WPA2, and WPA Mixed.

We strongly recommend that uses WPA2-PSK as your security settings.

6.2.1 WEP

Wireless Security

| | |
|---------------|---|
| Security Mode | WEP <input type="button" value="v"/> Notice: If WEP enabled, Data Rate for this SSID on legacy 11g. |
| Auth Type | Open System <input type="button" value="v"/> |
| Input Type | Hex <input type="button" value="v"/> |
| Key Length | 40/64-bit (10 hex digits or 5 ASCII char) <input type="button" value="v"/> |
| Default Key | 1 <input type="button" value="v"/> |
| Key1 | <input type="text"/> |
| Key2 | <input type="text"/> |
| Key3 | <input type="text"/> |
| Key4 | <input type="text"/> |

| | |
|----------------------|---|
| Security Mode | Select WEP from the drop down list to begin the configuration. |
| Auth Type | Select Auth Type in Open System or Shared . |
| Input Type | Select Input Type in Hex or ASCII . |
| Key Length | Select Key Length in 64/128/152 bit password length. |
| Default Key | Select the default index key for wireless security. |
| Key1 | Specify password for security key index No.1. |
| Key2 | Specify password for security key index No.2. |
| Key3 | Specify password for security key index No.3. |
| Key4 | Specify password for security key index No.4. |



802.11n does not allow WEP/WPA-PSK/WPA-PSK TKIP security mode. The date rate will drop from 802.11n to 802.11g.

6.2.2 WPA-PSK

Wireless Security

| | |
|---------------------------|--|
| Security Mode | WPA-PSK ▾ |
| Encryption | Both(TKIP+AES) ▾ Notice: If TKIP enabled, Data Rate for this SSID on legacy 11g. |
| Passphrase | <input type="text"/> (8 to 63 characters) or (64 Hexadecimal characters) |
| Group Key Update Interval | 3600 <input type="text"/> seconds(30~3600, 0: disabled) |

| | |
|----------------------------------|---|
| Security Mode | Select WPA-PSK from the drop down list to begin the configuration. |
| Encryption | Select Both , TKIP or AES for Encryption type. |
| Passphrase | Specify the security password. |
| Group Key Update Interval | Specify Group Key Update Interval time. |



802.11n does not allow WEP/WPA-PSK/WPA-PSK TKIP security mode. The data rate will drop from 802.11n to 802.11g.

6.2.3 WPA2-PSK

Wireless Security

| | |
|---------------------------|--|
| Security Mode | WPA2-PSK |
| Encryption | Both(TKIP+AES) Notice: If TKIP enabled, Data Rate for this SSID on legacy 11g. |
| Passphrase | <input type="text"/> (8 to 63 characters) or (64 Hexadecimal characters) |
| Group Key Update Interval | 3600 seconds(30~3600, 0: disabled) |

| | |
|----------------------------------|--|
| Security Mode | Select WPA2-PSK from the drop down list to begin the configuration. |
| Encryption | Select Both , TKIP or AES for Encryption type. |
| Passphrase | Specify the security password. |
| Group Key Update Interval | Specify Group Key Update Interval time. |



802.11n does not allow WEP/WPA-PSK/WPA-PSK TKIP security mode. The data rate will drop from 802.11n to 802.11g.

6.2.4 WPA-PSK Mixed

Wireless Security

| | |
|---------------------------|--|
| Security Mode | WPA-PSK Mixed ▾ |
| Encryption | Both(TKIP+AES) ▾ Notice: If TKIP enabled, Data Rate for this SSID on legacy 11g. |
| Passphrase | <input type="text"/> (8 to 63 characters) or (64 Hexadecimal characters) |
| Group Key Update Interval | 3600 seconds(30~3600, 0: disabled) |

| | |
|----------------------------------|---|
| Security Mode | Select WPA-PSK Mixed from the drop down list to begin the configuration. |
| Encryption | Select Both , TKIP or AES for Encryption type. |
| Passphrase | Specify the security password. |
| Group Key Update Interval | Specify Group Key Update Interval time. |



Uses WPA-PSK Mixed can allow multiple security modes at the same time.



802.11n does not allow WEP/WPA-PSK/WPA-PSK TKIP security mode. The data rate will drop from 802.11n to 802.11g.

6.2.5 WPA

Wireless Security

| | |
|---------------------------|--|
| Security Mode | WPA |
| Encryption | Both(TKIP+AES) Notice: If TKIP enabled, Data Rate for this SSID on legacy 11g. |
| Radius Server | . . . |
| Radius Port | 1812 |
| Radius Secret | |
| Group Key Update Interval | 3600 seconds(30~3600, 0: disabled) |

Save

Cancel

| | |
|----------------------------------|---|
| Security Mode | Select WPA from the drop down list to begin the configuration. |
| Encryption | Select Both , TKIP or AES for Encryption type. |
| Radius Server | Specify Radius Server IP Address. |
| Radius Port | Specify Radius Port number, the default port is 1812. |
| Radius Secret | Specify Radius Secret that is given by the Radius Server. |
| Group Key Update Interval | Specify Group Key Update Interval time. |



802.11n does not allow WEP/WPA-PSK/WPA-PSK TKIP security mode. The data rate will drop from 802.11n to 802.11g.

6.2.6 WPA2

Wireless Security

| | |
|---------------------------|--|
| Security Mode | WPA2 |
| Encryption | Both(TKIP+AES) Notice: If TKIP enabled, Data Rate for this SSID on legacy 11g. |
| Radius Server | . . . |
| Radius Port | 1812 |
| Radius Secret | |
| Group Key Update Interval | 3600 seconds(30~3600, 0: disabled) |

Save

Cancel

| | |
|----------------------------------|--|
| Security Mode | Select WPA2 from the drop down list to begin the configuration. |
| Encryption | Select Both , TKIP or AES for Encryption type. |
| Radius Server | Specify Radius Server IP Address. |
| Radius Port | Specify Radius Port number, the default port is 1812. |
| Radius Secret | Specify Radius Secret that is given by the Radius Server. |
| Group Key Update Interval | Specify Group Key Update Interval time. |



802.11n does not allow WEP/WPA-PSK/WPA-PSK TKIP security mode. The data rate will drop from 802.11n to 802.11g.

6.2.7 WPA Mixed

Wireless Security

| | |
|---------------------------|--|
| Security Mode | WPA Mixed |
| Encryption | Both(TKIP+AES) Notice: If TKIP enabled, Data Rate for this SSID on legacy 11g. |
| Radius Server | . . . |
| Radius Port | 1812 |
| Radius Secret | |
| Group Key Update Interval | 3600 seconds(30~3600, 0: disabled) |

Save

Cancel

| | |
|----------------------------------|---|
| Security Mode | Select WPA Mixed from the drop down list to begin the configuration. |
| Encryption | Select Both , TKIP or AES for Encryption type. |
| Radius Server | Specify Radius Server IP Address. |
| Radius Port | Specify Radius Port number, the default port is 1812. |
| Radius Secret | Specify Radius Secret that is given by the Radius Server. |
| Group Key Update Interval | Specify Group Key Update Interval time. |



802.11n does not allow WEP/WPA-PSK/WPA-PSK TKIP security mode. The data rate will drop from 802.11n to 802.11g.

6.4 Wireless Advanced Settings

Wireless Advanced Settings

[Home](#)
[Reset](#)

| | |
|------------------------------|---|
| Data Rate | Auto ▾ |
| Transmit Power | Auto |
| RTS/CTS Threshold (1 - 2346) | 2346 bytes |
| Distance (1-30km) | 3 km |
| Antenna Selection: | Vertical ▾ |
| Short GI: | Enable ▾ |
| Aggregation: | <input checked="" type="radio"/> Enable <input type="radio"/> Disable 32 Frames 50000 Bytes(Max) |

Wireless Traffic Shaping

| | |
|------------------------|---|
| Enable Traffic Shaping | <input type="radio"/> Enable <input checked="" type="radio"/> Disable |
| Incoming Traffic Limit | 1000 kbit/s |
| Outgoing Traffic Limit | 2000 kbit/s |

[Accept](#)
[Cancel](#)

Data Rate

Select Data Rate from the drop down list. Data rate will affect the efficiency of the throughput. If the data rate is set to a small number, the lower through will get but it can transmit to longer distance.

Transmit Power

Auto Transmit Power.

RTS/CTS Threshold

Specify Threshold package size for RTC/CTS. Using small number of the threshold will cause RTS/CTS packets to be sent more often to consuming more of the available bandwidth. In addition, if the heavy load traffic occurs, the wireless network can be recovered easily from interferences or collisions.

Distance

Specify distance rage between AP and Clients. Longer distance may lose high connection speed.

Antenna Selection

Specify the internal antenna type.

Short GI

Short GI is improved of 802.11n and 802.11a/g. It can increase 10% of the internet speed during the data transmission. For example, the 802.11a/g's GI is 800us, the short GI will be 400us.

Aggregation

Aggregation is to merge the typical size of data's header to one data. It

| | |
|---------------------------------|--|
| | is useful for the small size but larger amount packets. |
| Wireless Traffic Shaping | Place a Check to enable Wireless Traffic Shaping function. |
| Incoming Traffic Limit | Specify the wireless transmission speed for downloading. |
| Outgoing Traffic Limit | Specify the wireless transmission speed for uploading. |
| Accept / Cancel | Press Accept to confirm the changes or Cancel to return previous settings. |



1. Changing Wireless Advanced Settings may cause insufficient wireless connection quality. Please remain all settings as default unless you have acknowledged all changing that you have made.
2. Accept does not compile the changes, you must go to Status -> Save/Load to apply the new settings. Please refer to the chapter 4.1 for more detail.

6.5 Wireless MAC Filter

Wireless MAC Filters is used to Allow or Deny wireless clients, by their MAC addresses, accessing the Network. You can manually add a MAC address to restrict the permission to access ENH200. The default setting is Disable Wireless MAC Filters.

Wireless MAC Filter

[Home](#)[Reset](#)ACL Mode : : : : :

| # | MAC Address |
|---|-------------|
|---|-------------|

0.

| | |
|---------------------------|---|
| ACL Mode | ACL Mode can help to deny or allow certain Client to access the network. Select Disable, Deny MAC in the list or Allow MAC in the list from the drop down list. |
| MAC Address Filter | Specify the MAC address manually. |
| Add | Press Add to add the MAC address in the table. |
| Apply | Press Apply to apply the changes. |

6.6 WDS Link Settings

WDS Link Settings is used to establish a connection between Access Points but the device is not losing Access Point function. AP has WDS function can extend the wireless coverage and allow LANs to communicate each other.

WDS Link Settings

[Home](#)[Reset](#)

| ID | MAC Address | Mode |
|----|---|-----------|
| 1 | <input type="text"/> : <input type="text"/> : <input type="text"/> : <input type="text"/> : <input type="text"/> : <input type="text"/> | Disable ▾ |
| 2 | <input type="text"/> : <input type="text"/> : <input type="text"/> : <input type="text"/> : <input type="text"/> : <input type="text"/> | Disable ▾ |
| 3 | <input type="text"/> : <input type="text"/> : <input type="text"/> : <input type="text"/> : <input type="text"/> : <input type="text"/> | Disable ▾ |
| 4 | <input type="text"/> : <input type="text"/> : <input type="text"/> : <input type="text"/> : <input type="text"/> : <input type="text"/> | Disable ▾ |
| 5 | <input type="text"/> : <input type="text"/> : <input type="text"/> : <input type="text"/> : <input type="text"/> : <input type="text"/> | Disable ▾ |
| 6 | <input type="text"/> : <input type="text"/> : <input type="text"/> : <input type="text"/> : <input type="text"/> : <input type="text"/> | Disable ▾ |
| 7 | <input type="text"/> : <input type="text"/> : <input type="text"/> : <input type="text"/> : <input type="text"/> : <input type="text"/> | Disable ▾ |
| 8 | <input type="text"/> : <input type="text"/> : <input type="text"/> : <input type="text"/> : <input type="text"/> : <input type="text"/> | Disable ▾ |

[Accept](#)[Cancel](#)

MAC Address Enter the Access Point's MAC address that you would like to extend the wireless area.

Mode Select Disable or Enable from the drop down list.

Accept / Cancel Press Accept to confirm the changes or Cancel to return previous settings.

CAUTION

Accept does not compile the changes, you must go to Status -> Save/Load to apply the new settings. Please refer to the chapter 4.1 for more detail.

NOTE

The Access Point that you would like to extend the wireless area must enter your Access Point's MAC address. Not all Access Point supports this feature.

7 LAN Setup

This section will guide you to setup the Local Area Network (LAN) settings

7.1 IP Settings

This section is only available for **Non-Router Mode**. IP Settings allows you to LAN port IP address of the ENH200.

IP Settings

[Home](#)[Reset](#)

| | |
|--------------------|---|
| IP Network Setting | <input type="radio"/> Obtain an IP address automatically (DHCP) <input checked="" type="radio"/> Specify an IP address |
| IP Address | 192 . 168 . 1 . 1 |
| IP Subnet Mask | 255 . 255 . 255 . 0 |
| Default Gateway | 0 . 0 . 0 . 0 |
| Primary DNS | 0 . 0 . 0 . 0 |
| Secondary DNS | 0 . 0 . 0 . 0 |

[Apply](#)[Cancel](#)

| | |
|---------------------------|---|
| IP Network Setting | Select Radio button for Obtain an IP address automatically or Specify an IP address . |
| IP Address | Specify LAN port IP address. |
| IP Suet Mask | Specify Subnet Mask. |
| Default Gateway | Specify Default Gateway |
| Primary DNS | Specify Primary DNS |
| Secondary DNS | Specify Secondary DNS |
| Accept / Cancel | Press Accept to confirm the changes or Cancel to return previous settings. |



1. Obtain an IP address automatically is not a DHCP server. It means automatically get IP address when device connected to a device which has DHCP server.
2. Changing LAN IP Address will change LAN Interface IP address. Webpage will automatically redirect to the new IP address after Apply.

7.2 Spanning Tree Settings

Spanning Tree Settings

[Home](#)[Reset](#)

| | |
|----------------------|---|
| Spanning Tree Status | <input type="radio"/> On <input checked="" type="radio"/> Off |
| Bridge Hello Time | <input type="text" value="2"/> seconds (1-10) |
| Bridge Max Age | <input type="text" value="20"/> seconds (6-40) |
| Bridge Forward Delay | <input type="text" value="15"/> seconds (4-30) |
| Priority | <input type="text" value="32768"/> (0-65535) |

[Apply](#)[Cancel](#)

| | |
|-----------------------------|--|
| Spanning Tree Status | Select the Radio button to On or Off Spanning Tree function. |
| Bridge Hello Time | Specify Bridge Hello Time in second. |
| Bridge Max Age | Specify Bridge Max Age in second. |
| Bridge Forward Delay | Specify Bridge Forward Delay in second. |
| Priority | Specify the Priority number. Smaller number has greater priority. |
| Accept / Cancel | Press Accept to confirm the changes or Cancel to return previous settings. |

CAUTION

Accept does not compile the changes, you must go to Status -> Save/Load to apply the new settings. Please refer to the chapter 4.1 for more detail.

8 Router Settings

This section is only available for **AP Router Mode** and **Client Router Mode**.

8.1 WAN Settings

There are four different types of WAN connection: Static IP, DHCP, PPPoE and PPTP. Please contact your ISP to select the connection type.

8.1.1 Static IP

Select Static IP in WAN connection if your ISP gives all the information about IP address, Subnet Mask, Default Gateway, Primary DNS and Secondary DNS.

WAN Settings

[Home](#)[Reset](#)

| | |
|--------------------------|-------------|
| Internet Connection Type | Static IP ▼ |
|--------------------------|-------------|

Options

| | |
|----------------------------|----------------------|
| Account Name (if required) | <input type="text"/> |
| Domain Name (if required) | <input type="text"/> |
| MTU | Auto ▼ 1500 |

Internet IP Address

| | |
|--------------------|---|
| IP Address | <input type="text" value="0"/> . <input type="text" value="0"/> . <input type="text" value="0"/> . <input type="text" value="0"/> |
| IP Subnet Mask | <input type="text" value="0"/> . <input type="text" value="0"/> . <input type="text" value="0"/> . <input type="text" value="0"/> |
| Gateway IP Address | <input type="text" value="0"/> . <input type="text" value="0"/> . <input type="text" value="0"/> . <input type="text" value="0"/> |

Domain Name Server (DNS) Address

| | |
|---------------|---|
| Primary DNS | <input type="text" value="0"/> . <input type="text" value="0"/> . <input type="text" value="0"/> . <input type="text" value="0"/> |
| Secondary DNS | <input type="text" value="0"/> . <input type="text" value="0"/> . <input type="text" value="0"/> . <input type="text" value="0"/> |

WAN Ping

| | |
|---------------------|-------------------------------------|
| Discard Ping on WAN | <input checked="" type="checkbox"/> |
|---------------------|-------------------------------------|

[Apply](#)[Cancel](#)

| | |
|---------------------------------|---|
| Internet Connection Type | Select Static IP to begin configuration of the Static IP connection. |
| Account Name | Specify Account Name that is provided by ISP. |
| Domain Name | Specify Domain Name that is provided by ISP. |
| MTU | Specify the Maximum Transmit Unit size. Suggest remain in Auto. |
| IP Address | Specify WAN port IP address. |
| IP Subnet Mask | Specify WAN IP Subnet Mask. |
| Gateway IP Address | Specify WAN Gateway IP address. |
| Primary DNS | Specify Primary DNS IP. |
| Secondary DNS | Specify Secondary DNS IP. |
| Discard Ping on WAN | Place a Check to Enable or Disable ping from WAN. |
| Accept / Cancel | Press Accept to confirm the changes or Cancel to return previous settings. |



Accept does not compile the changes, you must go to Status -> Save/Load to apply the new settings. Please refer to the chapter 4.1 for more detail.



If the router's MTU is set too high, packets will be fragmented downstream. If the router's MTU is set too low, the router will fragment packets unnecessarily and in extreme cases may be unable to establish some connections. In either case, network performance can suffer.

8.1.2 DHCP (Dynamic IP)

Select DHCP as your WAN connection type to obtain your IP address automatically. You will need to enter Account Name as your hostname and DNS (Optional).

WAN Settings

[Home](#)[Reset](#)

Internet Connection Type

Options

Account Name (if required)

Domain Name (if required)

MTU

Domain Name Server (DNS) Address

Get Automatically From ISP

Use These DNS Servers

Primary DNS

Secondary DNS

WAN Ping

Discard Ping on WAN

| | |
|-----------------------------------|---|
| Internet Connection Type | Select DHCP to begin configuration of the DHCP connection. |
| Account Name | Specify Account Name that is provided by ISP. |
| Domain Name | Specify Domain Name that is provided by ISP. |
| MTU | Specify the Maximum Transmit Unit size. Suggest remain in Auto. |
| Get Automatically From ISP | Select the Radio button for get the DNS automatically from DHCP server. |
| Use These DNS Servers | Select the Radio button for setup the Primary DNS and Secondary DNS servers manually. |
| Discard Ping on WAN | Place a Check to Enable or Disable ping from WAN. |
| Accept / Cancel | Press Accept to confirm the changes or Cancel to return previous |

settings.

A rectangular button with a dark background and a red glow, containing the word "CAUTION" in red, bold, uppercase letters.

Accept does not compile the changes, you must go to Status -> Save/Load to apply the new settings. Please refer to the chapter 4.1 for more detail.

A rectangular button with a dark background and a yellow glow, containing the word "NOTE" in yellow, bold, uppercase letters.

If the router's MTU is set too high, packets will be fragmented downstream. If the router's MTU is set too low, the router will fragment packets unnecessarily and in extreme cases may be unable to establish some connections. In either case, network performance can suffer.

8.1.3 PPPoE (Point-to-Point Protocol over Ethernet)

Select PPPoE as your WAN connection type if your ISP provides Username and Password. PPPoE is a DSL service and please remove your PPPoE software from your computer, the software is not worked in ENH200.

WAN Settings

[Home](#)[Reset](#)

Internet Connection Type

PPPoE ▼

Options

MTU

Auto ▼ 1492

PPPoE Options

Login

Password

Service Name (if required)

Connect on Demand: Max idle Time 1 Minutes

Keep Alive: Redial Period 30 Seconds

Get Automatically From ISP

Use These DNS Servers

Primary DNS

0 . 0 . 0 . 0

Secondary DNS

0 . 0 . 0 . 0

WAN Ping

Discard Ping on WAN

[Apply](#)

[Cancel](#)

| | |
|---------------------------------|---|
| Internet Connection Type | Select PPPoE to begin configuration of the PPPoE connection. |
| MTU | Specify the Maximum Transmit Unit size. Suggest remain in Auto. |
| Login | Specify the Username that is given by your ISP. |
| Password | Specify the Password that is given by your ISP. |
| Service Name | Specify the Service Name that is given by your ISP. |
| Connect on Demand | Select the Radio button to specify the maximum idle time. Internet |

| | |
|-----------------------------------|--|
| | connection will disconnect when it reach the maximum idle time, but it will automatically connect when user tries to access the network. |
| Keep Alive | Select the Radio button to keep internet connection always on. Specify the redial period once the internet lose connection. |
| Get Automatically From ISP | Select the Radio button for get the DNS automatically from DHCP server. |
| Use These DNS Servers | Select the Radio button for setup the Primary DNS and Secondary DNS servers manually. |
| Discard Ping on WAN | Place a Check to Enable or Disable ping from WAN. |
| Accept / Cancel | Press Accept to confirm the changes or Cancel to return previous settings. |

A rectangular icon with a dark background and a red border, containing the word "CAUTION" in red, bold, uppercase letters.

Accept does not compile the changes, you must go to Status -> Save/Load to apply the new settings. Please refer to the chapter 4.1 for more detail.

A rectangular icon with a dark background and a yellow border, containing the word "NOTE" in yellow, bold, uppercase letters.

If the router's MTU is set too high, packets will be fragmented downstream. If the router's MTU is set too low, the router will fragment packets unnecessarily and in extreme cases may be unable to establish some connections. In either case, network performance can suffer.

8.1.4 PPTP (Point-to-Point Tunneling Protocol)

Select PPTP as your WAN connection type if your ISP provides information about IP Address, Subnet Mask, Default Gateway (Optional), DNS (Optional), Server IP, Username, and Password.

WAN Settings

[Home](#)[Reset](#)

Internet Connection Type PPTP

Options

MTU Auto 1460

PPTP Options

IP Address 192 . 168 . 2 . 1

Subnet Mask 255 . 255 . 255 . 0

Default Gateway 192 . 168 . 2 . 100

PPTP Server 0 . 0 . 0 . 0

Username

Password

Connect on Demand: Max idle Time 15 Minutes

Keep Alive: Redial Period 30 Seconds

Get Automatically From ISP

Use These DNS Servers

Primary DNS 0 . 0 . 0 . 0

Secondary DNS 0 . 0 . 0 . 0

WAN Ping

Discard Ping on WAN

[Apply](#)[Cancel](#)

Internet Connection Type Select **PPTP** to begin configuration of the PPTP connection.

MTU Specify the Maximum Transmit Unit size. Suggest remain in Auto.

IP Address Specify WAN port IP address.

| | |
|-----------------------------------|---|
| IP Subnet Mask | Specify WAN IP Subnet Mask. |
| Gateway IP Address | Specify WAN Gateway IP address. |
| PPTP Server | Specify PPTP Server IP address. |
| Username | Specify the Username that is given by your ISP. |
| Password | Specify the Password that is given by your ISP. |
| Connect on Demand | Select the Radio button to specify the maximum idle time. Internet connection will disconnect when it reach the maximum idle time, but it will automatically connect when user tries to access the network. |
| Keep Alive | Select the Radio button to keep internet connection always on. Specify the redial period once the internet lose connection. |
| Get Automatically From ISP | Select the Radio button for get the DNS automatically from DHCP server. |
| Use These DNS Servers | Select the Radio button for setup the Primary DNS and Secondary DNS servers manually. |
| Discard Ping on WAN | Place a Check to Enable or Disable ping from WAN. |
| Accept / Cancel | Press Accept to confirm the changes or Cancel to return previous settings. |



Accept does not compile the changes, you must go to Status -> Save/Load to apply the new settings. Please refer to the chapter 4.1 for more detail.



If the router's MTU is set too high, packets will be fragmented downstream. If the router's MTU is set too low, the router will fragment packets unnecessarily and in extreme cases may be unable to establish some connections. In either case, network performance can suffer.

8.2 LAN Settings (Router Mode)

LAN IP Setup

| | | | | | | | |
|----------------|-----|---|-----|---|-----|---|---|
| IP Address | 192 | . | 168 | . | 1 | . | 1 |
| IP Subnet Mask | 255 | . | 255 | . | 255 | . | 0 |

Use Router As DHCP Server

| | | | | | | | |
|---------------------|-----|---|-----|---|---|---|-----|
| Starting IP Address | 192 | . | 168 | . | 1 | . | 100 |
| Ending IP Address | 192 | . | 168 | . | 1 | . | 200 |
| WINS Server IP | 0 | . | 0 | . | 0 | . | 0 |

Accept

Cancel

| | |
|----------------------------------|--|
| IP Address | Specify LAN port IP address. |
| IP Subnet Mask | Specify LAN IP Subnet Mask. |
| WINS Server IP | Specify WINS Server IP. |
| Use Router As DHCP Server | Place a Check to enable DHCP server. |
| Starting IP Address | Specify DHCP server starting IP address. |
| Ending IP Address | Specify DHCP server ending IP address. |
| WINS Server IP | Specify the WINS Server IP address. |
| Accept / Cancel | Press Accept to confirm the changes or Cancel to return previous settings. |



Accept does not compile the changes, you must go to Status -> Save/Load to apply the new settings. Please refer to the chapter 4.1 for more detail.

8.3 VPN Pass Through

VPN Pass Through is used to allow certain protocol to be tunneled through an IP network such as PPTP and L2TP or implement secure exchange of packets at the IP Layer such as IPSec.

VPN Pass Through

[Home](#)[Reset](#) PPTP Pass Through L2TP Pass Through IPSec Pass Through[Apply](#)[Cancel](#)

| | |
|---------------------------|--|
| PPTP Pass Through | Place a Check to enable PPTP protocol passes through WAN. |
| L2TP Pass Through | Place a Check to enable L2TP protocol passes through WAN. |
| IPSec Pass Through | Place a Check to enable IPSec protocol passes through WAN. |
| Accept / Cancel | Press Accept to confirm the changes or Cancel to return previous settings. |

CAUTION

Accept does not compile the changes, you must go to Status -> Save/Load to apply the new settings. Please refer to the chapter 4.1 for more detail.

8.4 Port Forwarding

Port Forwarding is used to allow a public service such as Web Server, Mail Server, and FTP server to be set up. For example: Set up a Web Server on your computer with port number **8080**. Visitor on the internet can access your Web Server by entering **WAN Port IP** with port number **8080**. If your WAN Port IP is 192.168.5.1, then visitor must enter **http://192.168.5.1:8080**. To find out more the well known port numbers please search the internet.

Port Forwarding

[Home](#)
[Reset](#)

| # | Name | Protocol | Start Port | End Port | Server IP Address | Enable | Modify | Delete |
|---|------|----------|------------|----------|-------------------|--------|--------|--------|
|---|------|----------|------------|----------|-------------------|--------|--------|--------|

[Add Entry](#)
[Accept](#)

Add Entry Press Add Entry to add a rule of Port Forwarding.

Accept Press **Accept** to confirm the changes.



Accept does not compile the changes, you must go to Status -> Save/Load to apply the new settings. Please refer to the chapter 4.1 for more detail.

Port Forwarding

| | |
|---------------|---|
| Service Name | <input type="text"/> |
| Protocol | BOTH ▾ |
| Starting Port | <input type="text"/> (1~65535) |
| Ending Port | <input type="text"/> (1~65535) |
| IP Address | <input type="text"/> . <input type="text"/> . <input type="text"/> . <input type="text"/> |

[Save](#)
[Cancel](#)

Service Name Specify a name for current Port Forwarding rule.

Protocol Select a protocol from drop down list: Both, TCP and UDP.

Starting Port Specify Starting Port number.

Ending Port Specify Ending Port number.

IP Address Specify IP address.

Save / Cancel Press **Save** to apply the changes or **Cancel** to return previous settings.

8.5 DMZ

Enable DMZ will expose your network computer to the internet. This feature may be used in some circumstance such as Internet Gaming or Video Conference. DMZ will forward all the ports to one PC at the same time. This PC would be easily to attack because DMZ opens all the ports to one certain PC.

DMZ

[Home](#)[Reset](#)

| | |
|-------------|---|
| DMZ Hosting | Disable ▾ |
| DMZ Address | <input type="text"/> . <input type="text"/> . <input type="text"/> . <input type="text"/> |

[Apply](#)[Cancel](#)

| | |
|------------------------|--|
| DMZ Hosting | Select Enable or Disable DMZ from drop down list. |
| DMZ Address | Specify an IP address of DMZ. |
| Accept / Cancel | Press Accept to confirm the changes or Cancel to return previous settings. |



Accept does not compile the changes, you must go to Status -> Save/Load to apply the new settings. Please refer to the chapter 4.1 for more detail.

9 Management Settings

Management section is on the navigation drop-down menu. You will then see seven options: administration, management VLAN, SNMP settings, backup/restore settings, firmware upgrade, time settings, and log. Each option is described below.

9.1 Administration

Click on the **Administration** link under the **Management** menu. This option allows you to create a user name and password for the device. By default, this device is configured with a user name and password **admin**. For security reasons it is highly recommended that you create a new user name and password.

Administration

[Home](#)[Reset](#)

Administrator

| | |
|----------------------|------------------------------------|
| Name | <input type="text" value="admin"/> |
| New Password | <input type="password"/> |
| Confirm New Password | <input type="password"/> |

Remote Access

| | |
|------------------------|---|
| Remote Management | <input checked="" type="radio"/> Enable <input type="radio"/> Disable |
| Remote Upgrade | <input checked="" type="radio"/> Enable <input type="radio"/> Disable |
| Remote Management Port | <input type="text" value="8080"/> |

[Save/Apply](#)[Cancel](#)

| | |
|-------------------------------|---|
| Name | Specify Username for login. |
| Password | Specify a Password for login |
| Confirm Password | Re-enter the Password for confirmation. |
| Remote Management | Select the Radio button to Enable or Disable Remote Management. |
| Remote Upgrade | Select the Radio button to Enable or Disable Remote Upgrade. |
| Remote Management Port | Specify the Port number for Remote Management. For example: If you specify the Port number is 8080, then you will need to enter following http://<IP address>:8080 to access the web interface. |

| | |
|----------------------------|--|
| Save/Apply / Cancel | Press Save/Apply to apply the changes or Cancel to return previous settings. |
|----------------------------|--|



Press Save/Apply will change the setting immediately. It will not be able to undo the action.

9.2 Management VLAN

Click on the **Management VLAN** link under the **Management** menu. This option allows you to assign a VLAN tag to the packets. A VLAN is a group of computers on a network whose software has been configured so that they behave as if they were on a separate Local Area Network (LAN). Computers on VLAN do not have to be physically located next to one another on the LAN

Management VLAN Settings

[Home](#)[Reset](#)

Caution: If you reconfigure the Management VLAN ID, you may lose connectivity to the access point. Verify that the switch and DHCP server can support the reconfigured VLAN ID, and then re-connect to the new IP address.

Management VLAN ID

- No VLAN tag
- Specified VLAN ID
(must be in the range 1 ~ 4094.)

[Accept](#)[Cancel](#)

Management VLAN ID

If your network includes VLANs and if tagged packets need to pass through the Access Point, specify the VLAN ID into this field. If not, select the **No VLAN tag** radio button.

Accept / Cancel

Press Accept to confirm the changes or Cancel to return previous settings.



1. If you reconfigure the Management VLAN ID, you may lose connection to the ENH200. Verify DHCP server can support the reconfigured VLAN ID, and then re-connect to the new IP address.
2. Accept does not compile the changes, you must go to Status -> Save/Load to apply the new settings. Please refer to the chapter 4.1 for more detail.

9.3 SNMP Settings

Click on the **SNMP Settings** link under the **Management** menu. This is a networking management protocol used to monitor network-attached devices. SNMP allows messages (called protocol data units) to be sent to various parts of a network. Upon receiving these messages, SNMP-compatible devices (called agents) return data stored in their Management Information Bases.

SNMP Settings

[Home](#)[Reset](#)

| | |
|---------------------------------|---|
| SNMP | <input checked="" type="radio"/> Enable <input type="radio"/> Disable |
| Contact | <input type="text"/> |
| Location | <input type="text"/> |
| Community Name (Read Only) | public |
| Community Name (Read/Write) | private |
| Trap Destination Address | <input type="text"/> |
| Trap Destination Community Name | public |

[Save/Apply](#)[Cancel](#)

| | |
|--|---|
| SNMP Enable/Disable | Select the Radio button to Enable or Disable SNMP function. |
| Contact | Specify the contact details of the device. |
| Location | Specify the location of the device. |
| Community Name | Specify the password for access the SNMP community for read only access. |
| Community Name | Specify the password for access the SNMP community for read and write access. |
| Trap Destination IP Address | Specify the IP address that will receive the SNMP trap. |
| Trap Destination Community Name | Specify the password of the SNMP trap community. |
| Save/Apply / Cancel | Press Save/Apply to apply the changes or Cancel to return previous settings. |

CAUTION

Press Save/Apply will change the setting immediately. It will not be able to undo the action.

9.4 Backup/Restore Settings

Click on the **Backup/Restore Setting** link under the **Management** menu. This option is used to save the current settings of the device in a file on your local disk or load settings on to the device from a local disk. This feature is very handy for administrators who have several devices that need to be configured with the same settings.

Backup/Restore Settings

[Home](#)[Reset](#)

Save A Copy of Current Settings

Restore Saved Settings from A File

Revert to Factory Default Settings

Save A Copy of Current Settings

Click on **Backup** to save current configured settings.

Restore Saved Settings from a File

ENH200 can restore a previous setting that has been saved. Click on Browse to select the file and Restore.

Revert to Factory Default Settings

Click on Factory Default button to reset all the settings to the default values.

9.5 Firmware Upgrade

Click on the **Firmware Upgrade** link under the **Management** menu. This page is used to upgrade the firmware of the device. Make sure that downloaded the appropriate firmware from your vendor.

Firmware Upgrade

[Home](#)[Reset](#)

Current firmware version: 1.1.24

Locate and select the upgrade file from your hard disk:

CAUTION

Upgrade process may take few minutes, please do not power off the device and it may cause the device crashed or unusable. ENH200 will restart automatically once the upgrade is completed.

9.6 Time Settings

Click on the **Time Settings** link under the **Management** menu. This page allows you to configure the time on the device. You may do this manually or by connecting to a NTP server.

Time Settings

[Home](#) [Reset](#)

Time

Manually Set Date and Time

2010 / 10 / 19 13 : 13

Automatically Get Date and Time

Time Zone: UTC-12:00 Kwajalein

User defined NTP Server: 209.81.9.7

[Save/Apply](#) [Cancel](#)

Manually Set Date and Time

Manually setup the date and time.

Automatically Get Date and Time

Specify the Time Zone from the drop down list and Place a **Check** to specify the IP address of the NTP Server manually or uses default NTP Server.

Save/Apply / Cancel

Press Save/Apply to apply the changes or Cancel to return previous settings.



Press Save/Apply will change the setting immediately. It will not be able to undo the action.

9.7 Log

Click on the **Log** link under the **Management** menu. The **Log** page displays a list of events that are triggered on the Ethernet and Wireless interface. This log can be referred when an unknown error occurs on the system or when a report needs to be sent to the technical support department for debugging purposes.

Log [Home](#) [Reset](#)

Syslog

| | |
|-----------------------|---|
| Syslog | Disable ▾ |
| Log Server IP Address | <input type="text"/> . <input type="text"/> . <input type="text"/> . <input type="text"/> |

Local log

| | |
|-----------|----------|
| Local Log | Enable ▾ |
|-----------|----------|

[Save/Apply](#) [Cancel](#)

| | |
|------------------------------|--|
| Syslog | Select Enable or Disable Syslog function from the drop down list. |
| Log Server IP Address | Specify the Log Server IP address. |
| Local Log | Select Enable or Disable Local Log service. |
| Save/Apply / Cancel | Press Save/Apply to apply the changes or Cancel to return previous settings. |



Press Save/Apply will change the setting immediately. It will not be able to undo the action.

9.8 Diagnostics

Click on the **Diagnostics** link under the **Management** menu. This function allows you to detect connection quality and trace the routing table to the target.

Diagnostics

[Home](#)[Reset](#)

Ping Test Parameters

| | |
|------------------|---|
| Target IP | <input type="text"/> . <input type="text"/> . <input type="text"/> . <input type="text"/> |
| Ping Packet Size | 64 Bytes |
| Number of Pings | 4 |

Traceroute Test Parameters

| | |
|-------------------|----------------------|
| Traceroute target | <input type="text"/> |
|-------------------|----------------------|

| | |
|--------------------------|---|
| Target IP | Specify the IP address you would like to search. |
| Ping Packet Size | Specify the packet size of each ping. |
| Number of Pings | Specify how many times of ping. |
| Start Ping | Press Start Ping to begin. |
| Traceroute Target | Specify an IP address or Domain name you would like to trace. |
| Start Traceroute | Press Start Traceroute to begin. |

10 Network Configuration Example

This chapter describes the role of the ENH200 with 4+1 modes. The Access Point mode's default configuration is a central unit of the wireless network or as a root device of the wired environment. Repeater mode and Mesh network mode need future configuration.

10.1 Access Point

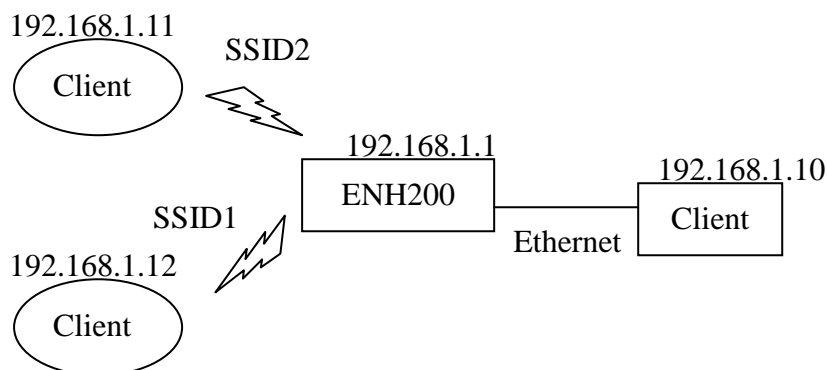

Access Point

| | |
|-------|---|
| Step1 | Login to the web-based configuration interface with default IP 192.168.1.1 |
| Step2 | Follow region's regulation. |
| Step3 | Use site survey to scan channels that have been used in nearby area. |
| Step4 | Select channel with less interferences. |
| Step5 | Specify the SSID for your broadcast SSID and you can also configure multiple SSID at the same time. |
| Step6 | Verify VLAN identifier to separate services among clients |
| Step7 | Setup the authentication settings. |
| Step8 | Apply to process all the configurations. |



For more advanced settings, please refer to the previous chapters.

Wireless Client

| | |
|-------|--|
| Step1 | Select wireless mode you would like to associate with. |
| Step2 | Use site survey to scan nearby Access Point and select the certain AP you would like to connect with or enter SSID manually. |
| Step3 | Configure VLAN ID in your wireless device if available. |
| Step4 | Select correct authentication type and password. |



ENH200's Access Point Mode does not provide DHCP server so the Wireless Client IP address must configure manually at the same subnet in Local Area Network.

10.2 Client Bridge Mode

Client Bridge Mode functions like a wireless dongle. It must connect to an Access Point/AP Router to join the network.

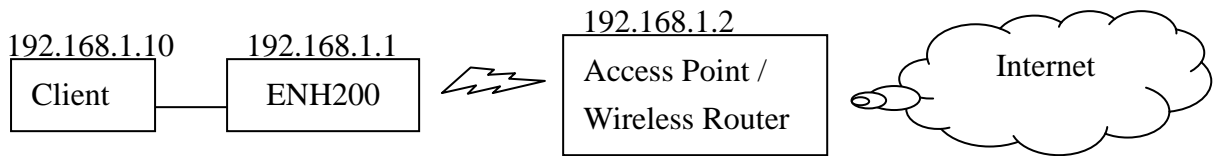

NOTE

Please refer to the last section to check Access point's configuration.

Client Bridge

| | |
|-------|--|
| Step1 | Login to the web-based configuration interface with default IP 192.168.1.1 |
| Step2 | Follow region's regulation. |
| Step3 | Select Operation Mode to Client Bridge from System Properties . |
| Step4 | Use site survey to scan Access Points that are available in nearby area. |
| Step5 | Select the AP you would like to associate with. |
| Step6 | Setup the authentication settings that match to the Access Point's setting. |
| Step7 | Apply to process all the configurations. |

TIP

Client Bridge's IP setting must match to the Access Point's subnet.

10.3 WDS Bridge Mode

Use this feature to link multiple APs in a network. All clients associated with any APs can communicate each other like an ad-hoc mode.

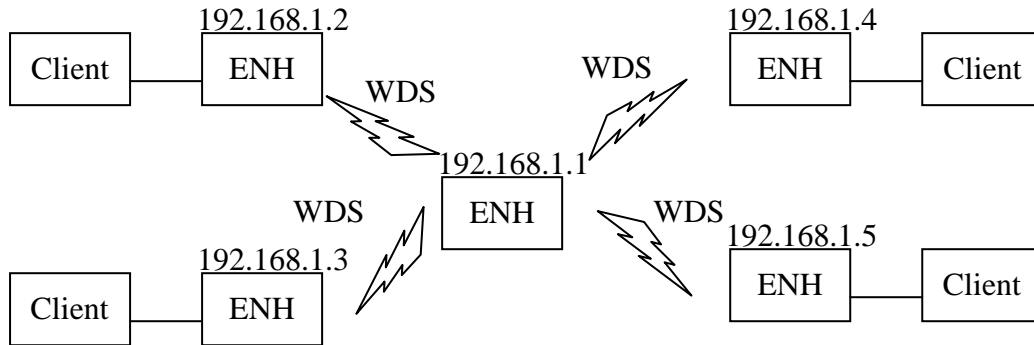

WDS Bridge

| | |
|-------|---|
| Step1 | Login to the web-based configuration interface with default IP 192.168.1.1 |
| Step2 | Follow region's regulation. |
| Step3 | Select Operation Mode to WDS Bridge from System Properties . |
| Step4 | Select channel you would like to use. |
| Step5 | Setup the authentication settings |
| Step6 | Setup WDS Link Settings. |
| Step7 | Specify the AP's MAC address you would like to connect with. |
| Step8 | Press Apply to process all the configurations. |

CAUTION

Each WDS bridge's device must use the same **Subnet**, **Wireless Mode**, **Wireless Channel**, and **Security Setting**.

10.4 Client Router

In the Client Router Mode, the ENH200 has DHCP Server build inside that allows many LANs automatically generate an IP address to share the same Internet. Connect an AP/WISP Wirelessly and connect to LANs via wired. Client Router Mode is act completely opposite to the AP Router Mode.

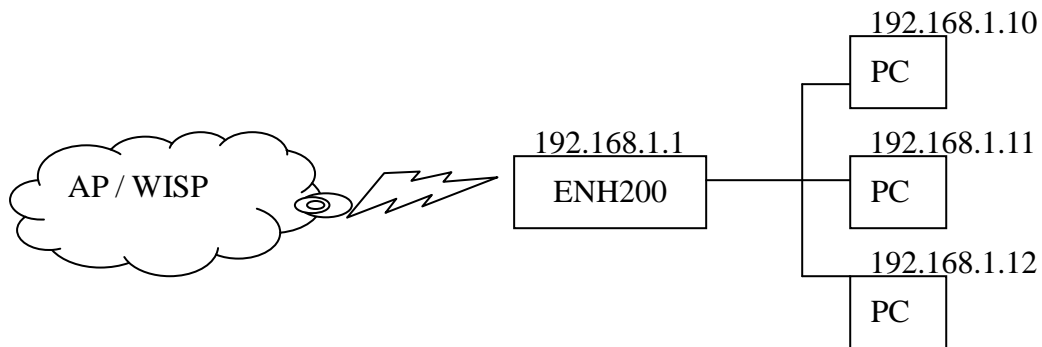

Please refer to the last section to check Access point's configuration.

Client Router

| | |
|-------|--|
| Step1 | Login to the web-based configuration interface with default IP 192.168.1.1 |
| Step2 | Follow region's regulation. |
| Step3 | Select Operation Mode to Client Router from System Properties . |
| Step4 | Change your Local Area Network setting to Obtain an IP Address Automatically . |
| Step5 | Use site survey to scan Access Points that are available in nearby area. |
| Step6 | Select the AP you would like to associate with. |
| Step7 | Setup the authentication settings that match to the Access Point's setting. |
| Step8 | Setup your WAN connection type given by your Internet Service Provider from WAN Settings . |
| Step9 | Press Apply to process all the configurations. |



Client Router's IP setting must match to the Access Point's subnet.

Federal Communication Commission Interference Statement

This equipment has been tested and found to comply with the limits for a Class B digital device, pursuant to Part 15 of the FCC Rules. These limits are designed to provide reasonable protection against harmful interference in a residential installation. This equipment generates, uses and can radiate radio frequency energy and, if not installed and used in accordance with the instructions, may cause harmful interference to radio communications. However, there is no guarantee that interference will not occur in a particular installation. If this equipment does cause harmful interference to radio or television reception, which can be determined by turning the equipment off and on, the user is encouraged to try to correct the interference by one of the following measures:

- Reorient or relocate the receiving antenna.
- Increase the separation between the equipment and receiver.
- Connect the equipment into an outlet on a circuit different from that to which the receiver is connected.
- Consult the dealer or an experienced radio/TV technician for help.

FCC Caution: Any changes or modifications not expressly approved by the party responsible for compliance could void the user's authority to operate this equipment.

This device complies with Part 15 of the FCC Rules. Operation is subject to the following two conditions: (1) This device may not cause harmful interference, and (2) this device must accept any interference received, including interference that may cause undesired operation.

IMPORTANT NOTE:

Radiation Exposure Statement:

This equipment complies with FCC radiation exposure limits set forth for an uncontrolled environment. This equipment should be installed and operated with minimum distance 20cm between the radiator & your body.

This transmitter must not be co-located or operating in conjunction with any other antenna or transmitter.

Note: Country selection is not available in the US model.

Industry Canada statement:

This device complies with RSS-210 of the Industry Canada Rules. Operation is subject to the following two conditions: (1) This device may not cause harmful interference, and (2) this device must accept any interference received, including interference that may cause undesired operation.

Ce dispositif est conforme à la norme CNR-210 d'Industrie Canada applicable aux appareils radio exempts de licence. Son fonctionnement est sujet aux deux conditions suivantes: (1) le dispositif ne doit pas produire de brouillage préjudiciable, et (2) ce dispositif doit accepter tout brouillage reçu, y compris un brouillage susceptible de provoquer un fonctionnement indésirable.

IMPORTANT NOTE:

Radiation Exposure Statement:

This equipment complies with IC radiation exposure limits set forth for an uncontrolled environment. This equipment should be installed and operated with minimum distance 20cm between the radiator & your body.

NOTE IMPORTANTE: (Pour l'utilisation de dispositifs mobiles)

Déclaration d'exposition aux radiations:

Cet équipement est conforme aux limites d'exposition aux rayonnements IC établies pour un environnement non contrôlé. Cet équipement doit être installé et utilisé avec un minimum de 20 cm de distance entre la source de rayonnement et votre corps.

Europe – EU Declaration of Conformity

This device complies with the essential requirements of the R&TTE Directive 1999/5/EC. The following test methods have been applied in order to prove presumption of conformity with the essential requirements of the R&TTE Directive 1999/5/EC:















- EN60950-1:2006 A11:2009
Safety of Information Technology Equipment
- EN50385 : 2002
Generic standard to demonstrate the compliance of electronic and electrical apparatus with the basic restrictions related to human exposure to electromagnetic fields (0 Hz - 300 GHz)
- EN 300 328 V1.7.1: 2006-10
Electromagnetic compatibility and Radio spectrum Matters (ERM); Wideband Transmission systems; Data transmission equipment operating in the 2,4 GHz ISM band and using spread spectrum modulation techniques; Harmonized EN covering essential requirements under article 3.2 of the R&TTE Directive
- EN 301 489-1 V1.8.1: 2008-04
Electromagnetic compatibility and Radio Spectrum Matters (ERM); ElectroMagnetic Compatibility (EMC) standard for radio equipment and services; Part 1: Common technical requirements
- EN 301 489-17 V2.1.1 2009-05
Electromagnetic compatibility and Radio spectrum Matters (ERM); ElectroMagnetic Compatibility (EMC) standard for radio equipment and services; Part 17: Specific conditions for 2,4 GHz wideband transmission systems and 5 GHz high performance RLAN equipment



This device is a 2.4 GHz wideband transmission system (transceiver), intended for use in all EU member states and EFTA countries, except in France and Italy where restrictive use applies.

In Italy the end-user should apply for a license at the national spectrum authorities in order to obtain authorization to use the device for setting up outdoor radio links and/or for supplying public access to telecommunications and/or network services.

This device may not be used for setting up outdoor radio links in France and in some areas the RF output power may be limited to 10 mW EIRP in the frequency range of 2454 – 2483.5 MHz. For detailed information the end-user should contact the national spectrum authority in France.

CE 0560

| | |
|---|--|
|  Český [Czech] | <i>[Jméno výrobce]</i> tímto prohlašuje, že tento <i>[typ zařízení]</i> je ve shodě se základními požadavky a dalšími příslušnými ustanoveními směrnice 1999/5/ES. |
|  Dansk [Danish] | Undertegnede <i>[fabrikantens navn]</i> erklærer herved, at følgende udstyr <i>[udstyrets typebetegnelse]</i> overholder de væsentlige krav og øvrige relevante krav i direktiv 1999/5/EF. |
|  Deutsch [German] | Hiermit erkläre <i>[Name des Herstellers]</i> , dass sich das Gerät <i>[Gerätetyp]</i> in Übereinstimmung mit den grundlegenden Anforderungen und den übrigen einschlägigen Bestimmungen der Richtlinie 1999/5/EG befindet. |
|  Eesti [Estonian] | Käesolevaga kinnitab <i>[tootja nimi = name of manufacturer]</i> seadme <i>[seadme tüüp = type of equipment]</i> vastavust direktiivi 1999/5/EÜ põhinõuetele ja nimetatud direktiivist tulenevatele teistele asjakohastele sätetele. |
|  English | Hereby, <i>[name of manufacturer]</i> , declares that this <i>[type of equipment]</i> is in compliance with the essential requirements and other relevant provisions of Directive 1999/5/EC. |
|  Español [Spanish] | Por medio de la presente <i>[nombre del fabricante]</i> declara que el <i>[clase de equipo]</i> cumple con los requisitos esenciales y cualesquiera otras disposiciones aplicables o exigibles de la Directiva 1999/5/CE. |
|  Ελληνική [Greek] | ΜΕ ΤΗΝ ΠΑΡΟΥΣΑ <i>[name of manufacturer]</i> ΔΗΛΩΝΕΙ ΟΤΙ <i>[type of equipment]</i> ΣΥΜΜΟΡΦΩΝΕΤΑΙ ΠΡΟΣ ΤΙΣ ΟΥΣΙΩΔΕΙΣ ΑΠΑΙΤΗΣΕΙΣ ΚΑΙ ΤΙΣ ΛΟΙΠΕΣ ΣΧΕΤΙΚΕΣ ΔΙΑΤΑΞΕΙΣ ΤΗΣ ΟΔΗΓΙΑΣ 1999/5/EK. |
|  Français [French] | Par la présente <i>[nom du fabricant]</i> déclare que l'appareil <i>[type d'appareil]</i> est conforme aux exigences essentielles et aux autres dispositions pertinentes de la directive 1999/5/CE. |
|  Italiano [Italian] | Con la presente <i>[nome del costruttore]</i> dichiara che questo <i>[tipo di apparecchio]</i> è conforme ai requisiti essenziali ed alle altre disposizioni pertinenti stabilite dalla direttiva 1999/5/CE. |
| Latviski [Latvian] | Ar šo <i>[name of manufacturer / izgatavotāja nosaukums]</i> deklarē, ka <i>[type of equipment / iekārtas tips]</i> atbilst Direktīvas 1999/5/EK būtiskajām prasībām un citiem ar to saistītajiem noteikumiem. |
| Lietuvių [Lithuanian] | Šiuo <i>[manufacturer name]</i> deklaruoja, kad šis <i>[equipment type]</i> atitinka esminius reikalavimus ir kitas 1999/5/EB Direktyvos nuostatas. |
|  Nederlands [Dutch] | Hierbij verklaart <i>[naam van de fabrikant]</i> dat het toestel <i>[type van toestel]</i> in overeenstemming is met de essentiële eisen en de andere relevante bepalingen van richtlijn 1999/5/EG. |
|  Malti [Maltese] | Hawnhekk, <i>[isem tal-manifattur]</i> , jiddikjara li dan <i>[il-mudel tal-prodott]</i> jikkonforma mal-ħtiġijiet essenzjali u ma provvedimenti oħrajn rilevanti li hemm fid-Dirrettiva 1999/5/EC. |
|  Magyar [Hungarian] | Alulírott, <i>[gyártó neve]</i> nyilatkozom, hogy a <i>[... típus]</i> megfelel a vonatkozó alapvető követelményeknek és az 1999/5/EC irányelv egyéb előírásainak. |
|  Polski [Polish] | Niniejszym <i>[nazwa producenta]</i> oświadcza, że <i>[nazwa wyrobu]</i> jest zgodny z zasadniczymi wymogami oraz pozostałymi stosownymi postanowieniami Dyrektywy 1999/5/EC. |
|  Português [Portuguese] | <i>[Nome do fabricante]</i> declara que este <i>[tipo de equipamento]</i> está conforme com os requisitos essenciais e outras disposições da Directiva 1999/5/CE. |
|  Slovensko [Slovenian] | <i>[Ime proizvajalca]</i> izjavlja, da je ta <i>[tip opreme]</i> v skladu z bistvenimi zahtevami in ostalimi relevantnimi določili direktive 1999/5/ES. |
| Slovensky | <i>[Meno výrobcu]</i> týmto vyhlasuje, že <i>[typ zariadenia]</i> spĺňa základné požiadavky a všetky príslušné |

| | |
|--|--|
| [Slovak] | ustanovenia Smernice 1999/5/ES. |
|  Suomi [Finnish] | <i>[Valmistaja = manufacturer]</i> vakuuttaa täten että <i>[type of equipment = laitteen tyyppimerkintä]</i> tyyppinen laite on direktiivin 1999/5/EY oleellisten vaatimusten ja sitä koskevien direktiivin muiden ehtojen mukainen. |
|  Svenska [Swedish] | Härmed intygar <i>[företag]</i> att denna <i>[utrustningstyp]</i> står i överensstämmelse med de väsentliga egenskapskrav och övriga relevanta bestämmelser som framgår av direktiv 1999/5/EG. |