

AP130 User Guide

The AP130 wireless access point provides dual concurrent 2.4 GHz 802.11b/g/n and 5 GHz 802.11a/n/ac radios for 2x2:2 MIMO (multiple input multiple output) antennas. These devices have built-in mounting hardware that allows you to install them on a ceiling track or a wall. This guide covers the following topics about the AP130.

- "[AP130 Product Overview](#)" on page 1
- "[Hardware Components](#)" on page 2
- "[Safety Instructions and Site Hazard Warnings](#)" on page 2
- "[Installing the AP130](#)" on page 3
- "[Accessing the Reset Button](#)" on page 5
- "[AP130 LEDs](#)" on page 5
- "[Connecting to the Network](#)" on page 5
- "[Device, Power, and Environmental Specifications](#)" on page 6
- "[Compliance and Regulatory Information](#)" on page 6

To register, get the latest product documentation, see compliance information, and download software updates, visit www.aerohive.com/support. For detailed hardware information about this device, visit www.aerohive.com/quick.

AP130 Product Overview

This guide explains how to install the AP130 on a wall or flat surface, or to the tracks of a recessed ceiling, and connect it to Aerohive HiveManager over the network.

Kit Contents, Required Accessories, and Tools

The AP130 kit includes the following items:

- AP130 chassis
- QuickStart Guide
- Diagonal mount bracket
- Hardware kit: Three wall mount screws with anchors, two security screws, and two cross-head screws

To install your AP130, you will need a crosshead screwdriver, a flat blade screwdriver, and a drill (for wall mounts).

Hardware Components

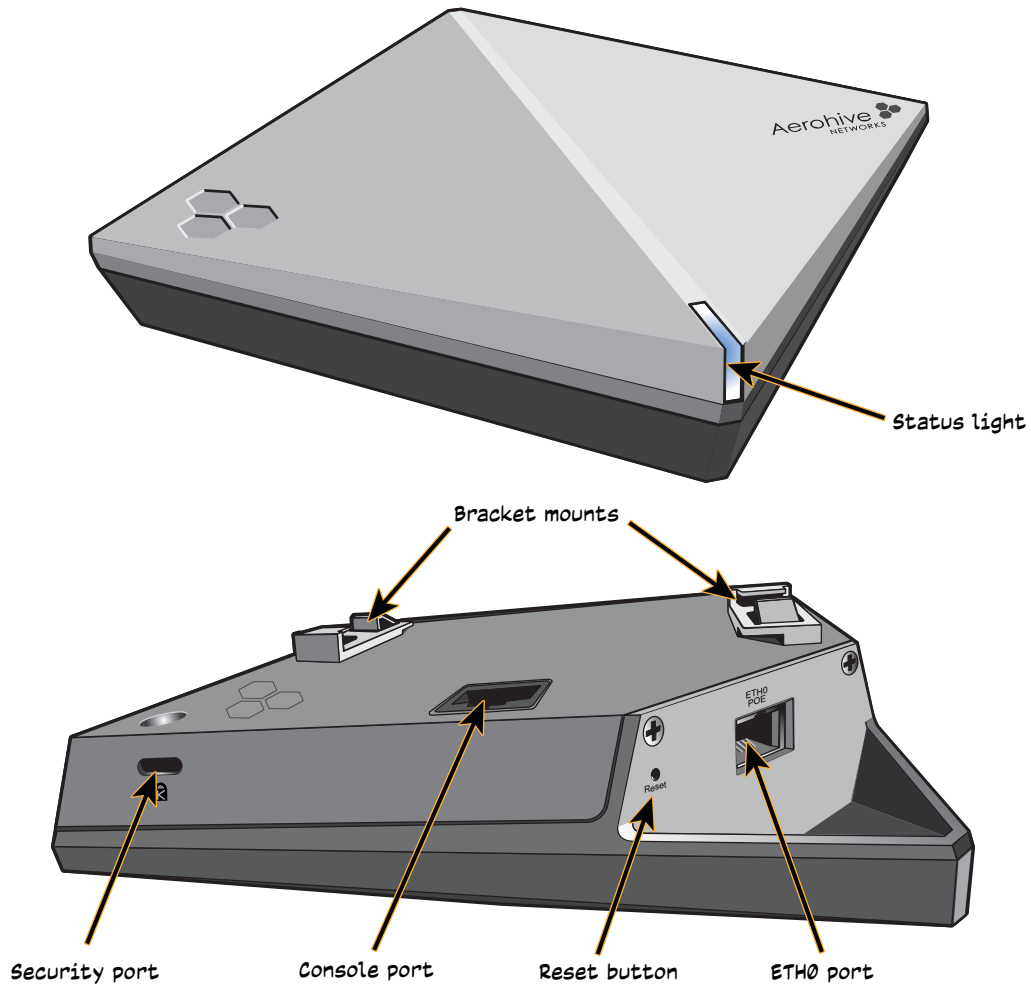

The following illustration shows the AP130 hardware components. For detailed descriptions of these components and additional specifications, see the online Help for the AP130 at www.aerohive.com/quick.











Safety Instructions and Site Hazard Warnings

Read and follow these safety instructions and hazard warnings before installing an AP130. Keep these instructions for future reference.

The following icons are used to identify the type of caution or warning in this document:

	This icon indicates a general caution. Failure to comply with a caution notification can result in damage to equipment.
	This icon indicates an electrical caution. Failure to comply with an electrical notification can result in serious injury or death, and extensive damage to equipment.

Refer to the following cautions and warnings when installing your AP130.

	Aerohive devices must be installed by a professional installer who is certified to install these types of devices and to ensure that they are properly grounded and meet applicable local and national electrical codes.
	Do not install the device in an environment where the operating ambient temperature might exceed the recommended ranges.
	Changes or modifications made to this device that are not expressly approved by the party responsible for compliance could void the user's authority to operate the equipment.
	For products available in the USA/Canada market, for the 2.4 GHz band, only channels 1-11 can be operated. Selection of other channels is not possible.
	Use only attachments and accessories specified by Aerohive.
	These devices are not intended for use by persons (including children) with reduced physical, sensory, or mental capabilities, or with lack of experience or knowledge unless they are given supervision or instruction concerning use of the devices by a person who is responsible for their safety. Children should be supervised to ensure that they do not play with the devices.
	Electrostatic discharge (ESD) can damage equipment and impair electrical circuitry. ESD damage occurs when electronic components are improperly handled and can result in complete or intermittent failures. Be sure to follow ESD-prevention procedures when handling electronic components.
	During operation, the surfaces of the AP130 can become hot. Use caution when handling.

Installing the AP130

 You can mount the AP130 outdoors on a flat surface, on a wall, or on the tracks of a dropped ceiling grid using the mounting bracket that ships with the device. Use the locking bracket and a security screw to lock the device in place once it is mounted.

 To meet federal radiation exposure requirements, these devices should be installed at a minimum distance of 9 inches (20 cm) from your body.

Make sure that you have all the materials and tools necessary, and familiarize yourself with the safety and site hazard warnings before you install the device.

Ceiling Mount

The following steps explain how to mount the AP130 on the track of a dropped ceiling. For a diagonal mount, you will need the mounting bracket. For a square mount, you can use the mounts that are built into the device chassis. You may need to drill a small hole in the adjacent ceiling tile to accommodate the cable.

1. Lift the ceiling tiles adjacent to the location on the track where you want to install the device for better access. You can slide the device along the track to adjust the installation location.
2. For a diagonal mount, attach the bracket to the back of the device with the Aerohive logo facing away from the device. Slip the tabs on the device into the tab slots on the bracket. Rotate the bracket until the clips snap into place, and the flanges fit securely underneath the edge of the bracket mount, as shown in this illustration.

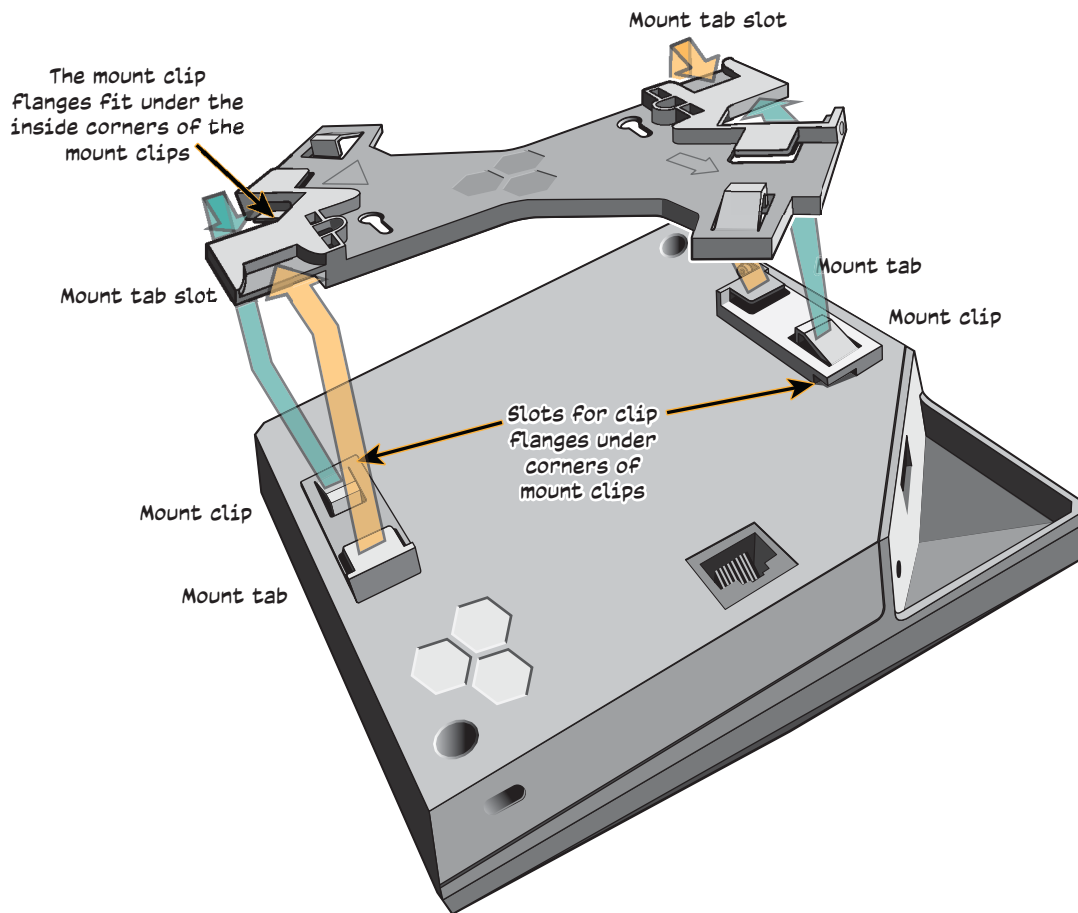

3. Hold the device upside down and slip the mounting tabs on the bracket over each side of the ceiling track.
4. Press the device gently against the ceiling track and rotate it until the mount clips click into place.
5. For a square mount, repeat Steps 2 and 3 using the mount tabs and clips on the bottom of the device (you do not need the bracket).
6. To remove the device, press the mount clips until they disengage from the track, then rotate the device and pull it away from the track. A flat-blade screwdriver can make it easier to access and press the clips.

Wall Mount

Use the diagonal mounting bracket to attach the AP to any vertical surface that supports its weight, and to which you can install wall mount screws. To mount the AP130 on a vertical surface, do the following:

1. Use the holes in the mounting bracket as a template to mark the wall for the location of the mounting screws.
2. Drill two holes that are slightly smaller in diameter than the mounting screws.
3. Install two wall mount screws in the holes. Use screw anchors if necessary.

(i) If you are not installing the device on a concrete wall, you can use threaded screws and plastic wall anchors (not supplied) to mount the device.

- Attach the mounting bracket to the back of the device with the Aerohive logo facing away from the device, as shown in the illustration for a ceiling mount. Slip the tabs on the device into the tab slots on the bracket. Rotate the bracket until the clips snap into place, and the flanges fit securely underneath the edge of the bracket mounts.

To remove the bracket, press the clips until they disengage from the mounts on the chassis. Rotate the bracket and slide the tabs out of the bracket tab slots.

- Insert the heads of the wall screws into the large end of the bracket keyholes and slide the device down until the screws rest in the narrow end of the keyholes.
- The AP130 is PoE-powered, so you must connect an Ethernet cable directly from the ETH0 port to a PoE-enabled switch or to a PoE injector.

Locking the AP130

You can secure the AP using a Kensington lock in the security slot on the side of the device.

Accessing the Reset Button

The Reset button is located on the corner panel near the ETH0 port. To access it, use a paper clip or similar tool to push the button in between 1 and 5 seconds to reboot the device, or for 5 seconds or more to return the device to the factory default settings.

AP130 LEDs

The AP130 has a Status LED bar on the top and front corner of the unit. The LED colors and what they indicate are described below.

- Dark:** no power to the device.
- Amber (steady):** the device has not made a CAPWAP connection.
- Amber (flashing):** the device is undergoing a firmware upgrade.
- White:** the device is operating properly.

Connecting to the Network

The final step to the installation is to connect the AP to the network so that it can form a CAPWAP (Control and Provisioning of Wireless Access Points) connection to HiveManager. CAPWAP is a protocol that access points use to contact and communicate with a management device.

When you connect the AP to an Ethernet network, it automatically attempts to get network settings through DHCP and contact HiveManager. The process takes about five minutes. When you see the AP listed in the HiveManager GUI, the initial setup is complete and you can begin managing the AP with HiveManager.

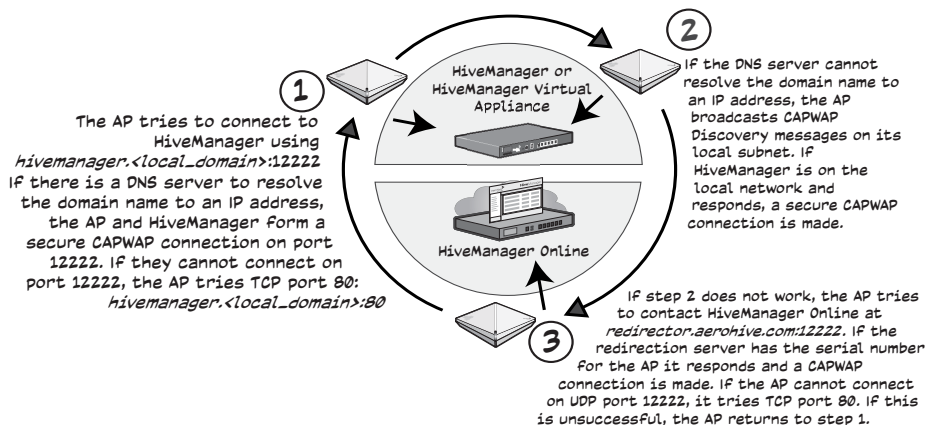

Optional Accessories

Aerohive offers a variety of AP130 accessories. Contact your sales representative for more information.

Device, Power, and Environmental Specifications

Understanding the range of specifications for the AP130 is necessary for optimal deployment and device operations. The following specifications describe the physical features and hardware components, the PoE requirements, and the temperature and humidity ranges in which the devices can operate.]

Device Specifications

- Chassis dimensions: 5.75" W x 1.5" H x 5.75" D (146 mm x 38 x 146 mm)
- Weight: 19 oz (0.54 kg)
- Two internal 802.11b/g/n 2.4 GHz antennas, and two internal 802.11a/n/ac 5 GHz antennas
- Console serial port: RJ45 (9600 bits per second, 8 data bits, parity: none, 1 stop bit, no flow control)
- Ethernet port: Eth0 autosensing 10/100/1000 Base-T/TX Mbps, with IEEE 802.3af-compliant PoE

Power Specifications

- PoE nominal input voltages: 48 V
- RJ45 power input pins: wires 4, 5, 7, and 8 or 1, 2, 3, and 6

Environmental Specifications

- Operating temperature: 32° to 104° F (0° to 40 C)
- Storage temperature: -40° to 185° F (-40° to 85° C)
- Relative humidity: 5 to 95% RH (noncondensing)

Compliance and Regulatory Information

AP130 Compliance Statement Europe

EU Declaration of Conformity

This device complies with the essential requirements of the R&TTE Directive 1999/5/EC. The following test methods have been applied in order to prove presumption of conformity with the essential requirements of the R&TTE Directive 1999/5/EC:

IEC 60950-1:2005+AM1:2009: Safety of Information Technology Equipment

EN 62311: 2008 / Article 3(1)(a) and Article 2 2006/95/EC): Assessment of electronic and electrical equipment related to human exposure restrictions for electromagnetic fields (0 Hz-300 GHz).

EN 300 328 V1.8.1: 2012-06: Electromagnetic compatibility and Radio spectrum Matters (ERM); Wideband transmission systems; Data transmission equipment operating using wide band modulation techniques; Harmonized EN covering the essential requirements of article 3.2 of the R&TTE Directive.

EN 301 893 V1.7.1: 2012-06: Broadband Radio Access Networks (BRAN); 5 GHz high performance RLAN; Harmonized EN covering the essential requirements of article 3.2 of the R&TTE Directive.

EN 301 489-1 V1.9.2: 2011: Electromagnetic compatibility and Radio spectrum Matters (ERM); Electromagnetic Compatibility (EMC) standard for radio equipment and services; Part 1: Common technical requirements.

EN 301 489-17 V2.2.1 2012: Electromagnetic compatibility and Radio spectrum Matters (ERM); Electromagnetic Compatibility (EMC) standard for radio equipment; Part 17: Specific conditions for Broadband Data Transmission Systems.

In Italy the end-user should apply for a license at the national spectrum authorities in order to obtain authorization to use the device for setting up outdoor radio links and/or for supplying public access to telecommunications and/or network services.

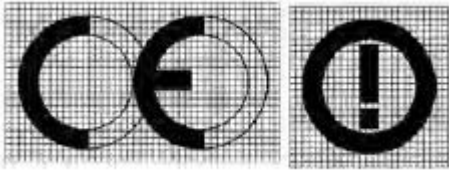

- **Česky [Czech]:** [Aerohive] tímto prohlašuje, že tento [AP130] je ve shodě se základními požadavky a dalšími příslušnými ustanoveními směrnice 1999/5/ES.
- **Dansk [Danish]:** Undertegnede [Aerohive] erklærer herved, at følgende udstyr [AP130] overholder de væsentlige krav og øvrige relevante krav i direktiv 1999/5/EF.
- **Deutsch [German]:** Hiermit erkläre [Aerohive], dass sich das Gerät [AP130] in Übereinstimmung mit den grundlegenden Anforderungen und den übrigen einschlägigen Bestimmungen der Richtlinie 1999/5/EG befindet.
- **Eesti [Estonian]:** Käesolevaga kinnitab [Aerohive] seadme [AP130] vastavust direktiivi 1999/5/EÜ põhinõuetele ja nimetatud direktiivist tulenevatele teistele asjakohastele sätetele.
- **English:** Hereby, [Aerohive], declares that this [AP130] is in compliance with the essential requirements and other relevant provisions of Directive 1999/5/EC.
- **Español [Spanish]:** Por medio de la presente [Aerohive] declara que el [AP130] cumple con los requisitos esenciales y cualesquiera otras disposiciones aplicables o exigibles de la Directiva 1999/5/CE.
- **Ελληνική [Greek]:** ΜΕ ΤΗΝ ΠΑΡΟΥΣΑ [Aerohive] ΔΗΛΩΝΕΙ ΟΤΙ [AP130] ΣΥΜΜΟΡΦΩΝΕΤΑΙ ΠΡΟΣ ΤΙΣ ΟΥΣΙΩΔΕΙΣ ΑΠΑΙΤΗΣΕΙΣ ΚΑΙ ΤΙΣ ΛΟΙΠΕΣ ΣΧΕΤΙΚΕΣ ΔΙΑΤΑΞΕΙΣ ΤΗΣ ΟΔΗΓΙΑΣ 1999/5/EK.
- **Français [French]:** Par la présente [Aerohive] déclare que l'appareil [AP130] est conforme aux exigences essentielles et aux autres dispositions pertinentes de la directive 1999/5/CE.
- **Italiano [Italian]:** Con la presente [Aerohive] dichiara che questo [AP130] è conforme ai requisiti essenziali ed alle altre disposizioni pertinenti stabilite dalla direttiva 1999/5/CE.
- **Latviski [Latvian]:** Ar šo [Aerohive] deklarē, ka [AP130] atbilst Direktīvas 1999/5/EK būtiskajām prasībām un citiem ar to saistītajiem noteikumiem.
- **Lietuvių [Lithuanian]:** Šiuo [Aerohive] deklaruoja, kad šis [AP130] atitinka esminius reikalavimus ir kitas 1999/5/EB Direktyvos nuostatas.
- **Nederlands [Dutch]:** Hierbij verklaart [Aerohive] dat het toestel [AP130] in overeenstemming is met de essentiële eisen en de andere relevante bepalingen van richtlijn 1999/5/EG.
- **Malti [Maltese]:** Hawnehkk, [Aerohive], jiddikjara li dan [AP130] jikkonforma mal-ħtiġijiet essenzjali u ma provvedimenti oħrajn rilevanti li hemm fid-Dirrettiva 1999/5/EC.
- **Magyar [Hungarian]:** Alulírott, [Aerohive] nyilatkozom, hogy a [AP130] megfelel a vonatkozó alapvető követelményeknek és az 1999/5/EC irányelv egyéb előírásainak.
- **Polski [Polish]:** Niniejszym [Aerohive] oświadczam, że [AP130] jest zgodny z zasadniczymi wymogami oraz pozostałymi stosownymi postanowieniami Dyrektywy 1999/5/EC.
- **Português [Portuguese]:** [Aerohive] declara que este [AP130] está conforme com os requisitos essenciais e outras disposições da Directiva 1999/5/CE.
- **Slovensko [Slovenian]:** [Aerohive] izjavlja, da je ta [AP130] v skladu z bistvenimi zahtevami in ostalimi relevantnimi določili direktive 1999/5/ES.
- **Slovensky [Slovak]:** [Aerohive] týmto vyhlasuje, že [AP130] spĺňa základné požiadavky a všetky príslušné ustanovenia Smernice 1999/5/ES.
- **Suomi [Finnish]:** [Aerohive] vakuuttaa täten että [AP130] tyyppinen laite on direktiivin 1999/5/EY oleellisten vaatimusten ja sitä koskevien direktiivin muiden ehtojen mukainen.

Federal Communication Commission Interference Statement

This equipment has been tested and found to comply with the limits for a Class B digital device, pursuant to Part 15 of the FCC Rules. These limits are designed to provide reasonable protection against harmful interference in a residential installation. This equipment generates, uses and can radiate radio frequency energy and, if not installed and used in accordance with the instructions, may cause harmful interference to

radio communications. However, there is no guarantee that interference will not occur in a particular installation. If this equipment does cause harmful interference to radio or television reception, which can be determined by turning the equipment off and on, the user is encouraged to try to correct the interference by one of the following measures:

- Reorient or relocate the receiving antenna.
- Increase the separation between the equipment and receiver.
- Connect the equipment into an outlet on a circuit different from that to which the receiver is connected.
- Consult the dealer or an experienced radio/TV technician for help.

FCC Caution:

Any changes or modifications not expressly approved by the party responsible for compliance could void the user's authority to operate this equipment.

This device complies with Part 15 of the FCC Rules. Operation is subject to the following two conditions:

- (1) This device may not cause harmful interference, and
- (2) this device must accept any interference received, including interference that may cause undesired operation.

For products available in the USA/Canada market, only channels 1-11 can be operated. Selection of other channels is not possible.

This transmitter must not be co-located or operating in conjunction with any other antenna or transmitter.

Country Code selection feature to be disabled for products marketed to the US/CANADA.

This device and its antenna(s) must not be co-located or operating in conjunction with any other antenna or transmitter except in accordance with FCC multi-transmitter product procedures.

If this device operates in the 5.15~5.25GHz frequency range, it is restricted to indoor use only.

IMPORTANT NOTE - Radiation Exposure Statement:

This equipment complies with FCC radiation exposure limits set forth for an uncontrolled environment. This equipment should be installed and operated with minimum distance of 20 cm between the radiator and your body.

Industry Canada Statement:

This device complies with Industry Canada license-exempt RSS standard(s). Operation is subject to the following two conditions:

1. This device may not cause interference, and
2. This device must accept any interference, including interference that may cause undesired operation of the device.

Le présent appareil est conforme aux CNR d'Industrie Canada applicables aux appareils radio exempts de licence. L'exploitation est autorisée aux deux conditions suivantes :

1. l'appareil ne doit pas produire de brouillage, et
2. l'utilisateur de l'appareil doit accepter tout brouillage radioélectrique subi, même si le brouillage est susceptible d'en compromettre le fonctionnement.

For product available in the USA/Canada market, only channel 1~11 can be operated. Selection of other channels is not possible.

Pour les produits disponibles aux États-Unis / Canada du marché, seul le canal 1 à 11 peuvent être exploités. Sélection d'autres canaux n'est pas possible.

Caution:

The device for the band 5150-5250 MHz is only for indoor usage to reduce potential for harmful interference to co-channel mobile satellite systems.

Avertissement:

les dispositifs fonctionnant dans la bande 5150-5250 MHz sont réservés uniquement pour une utilisation à l'intérieur afin de réduire les risques de brouillage préjudiciable aux systèmes de satellites mobiles utilisant les mêmes canaux;

Radiation Exposure Statement:

This equipment complies with IC RSS-102 radiation exposure limits set forth for an uncontrolled environment. This equipment should be installed and operated with minimum distance 20 cm between the radiator and your body.

Déclaration d'exposition aux radiations:

Cet équipement est conforme aux limites d'exposition aux rayonnements IC établies pour un environnement non contrôlé. Cet équipement doit être installé et utilisé avec un minimum de 20 cm de distance entre la source de rayonnement et votre corps.

IMPORTANT NOTE: IC Radiation Exposure Statement:

This equipment complies with IC RSS-102 radiation exposure limits set forth for an uncontrolled environment. This equipment should be installed and operated with minimum distance 20 cm (8") between the radiator and your body.

Cet équipement est conforme aux limites d'exposition aux rayonnements IC établies pour un environnement non contrôlé. Cet équipement doit être installé et utilisé avec un minimum de 20 cm de distance entre la source de rayonnement et votre corps.

Under Industry Canada regulations, this radio transmitter may only operate using an antenna of a type and maximum (or lesser) gain approved for the transmitter by Industry Canada. To reduce potential radio interference to other users, the antenna type and its gain should be so chosen that the equivalent isotropically radiated power (e.i.r.p.) is not more than that necessary for successful communication.

Conformément à la réglementation d'Industrie Canada, le présent émetteur radio peut fonctionner avec une antenne d'un type et d'un gain maximal (ou inférieur) approuvé pour l'émetteur par Industrie Canada. Dans le but de réduire les risques de brouillage radioélectrique à l'intention des autres utilisateurs, il faut choisir le type d'antenne et son gain de sorte que la puissance isotrope rayonnée équivalente (p.i.r.e.) ne dépasse pas l'intensité nécessaire à l'établissement d'une communication satisfaisante.

Taiwan Compliance Information

Aerohive AP130

第十二條→經型式認證合格之低功率射頻電機，非經許可，公司、商號或使用者均不得擅自變更頻率、加大功率或變更原設計之特性及功能。
第十四條→低功率射頻電機之使用不得影響飛航安全及干擾合法通信；經發現有干擾現象時，應立即停用，並改善至無干擾時方得繼續使用。
前項合法通信，指依電信法規定作業之無線電通信。低功率射頻電機須忍受合法通信或工業、科學及醫療用電波輻射性電機設備之干擾。

在 5.25-5.35 兆赫頻帶內操作之無線資訊傳輸設備，限於室內使用。
無線資訊傳輸設備的製造廠商應確保頻率穩定性，如依製造廠商使用手冊上所述正常操作，發射的信號應維持於操作頻帶中。

Taiwan MPE Warning

Aerohive AP130

電磁波曝露量MPE標準值(MPE) $1\text{mW}/\text{cm}^2$ ，送測產品實值為 $0.734\text{ mW}/\text{cm}^2$

NCC Statement

- (1) 「經型式認證合格之低功率射頻電機，非經許可，公司、商號或使用者均不得擅自變更頻率、加大功率或變更原設計之特性及功能」。
- (2) 「低功率射頻電機之使用不得影響飛航安全及干擾合法通信；經發現有干擾現象時，應立即停用，並改善至無干擾時方得繼續使用。前項合法通信，指依電信法規定作業之無線電通信。低功率射頻電機須忍受合法通信或工業、科學及醫療用電波輻射性電機設備之干擾」。
- (3) 「不致造成違反低功率電波輻射性電機管理辦法之所有控制、調整及開關之使用方法」。
- (4) 「對任何可能造成違反管理辦法規定之調整予以警告，或建議由具有發射機維修專長之技術人員執行或由其直接監督及負責」。
- (5) 「對任何可能造成違反管理辦法之零件（晶體、半導體等）置換之警告」。
- (6) 「電磁波曝露量 MPE 標準值 $1\text{mW}/\text{cm}^2$ ，送測產品實測值為：___ mW/cm^2 」。
- (7) 「電磁波曝露量 MPE 標準值 $1\text{mW}/\text{cm}^2$ ，本產品使用時建議應距離人體：___ cm 」。
- (8) 「5.25-5.35 GHz 頻帶內操作之無線資訊傳輸設備，限於室內使用」。
並於該中文使用說明書及器材上標示
- (9) 「本器材須經專業工程人員安裝及設定，始得設置使用，且不得直接販售給一般消費者」。

© 2015 Aerohive Networks, Inc.

Aerohive is a U.S. registered trademark of Aerohive Networks, Inc.