



User manual

Welcome

Thank you for choosing Freedocast PRO

[Go Live Now !](#)

Contents

What's in the Package	4
Device description	5
LED Status	7
Go Live with Freedocast Pro	8
Register your Freedocast Pro Device	9
Download Freedocast Pro app	11
Configure your Freedocast Pro Device	12
Connect Device to App (Android)	13
Connect Device to App (iOS)	15
Start a Live broadcast	18

Contents

Encoder specifications	19
Battery specifications	20
Power adapter specifications	21
Certificate	22
Warranty	23
Battery model, Liability	24
Device Software update	24

What's in the Package



Freedocast Pro Device



Hot Shoe



Ethernet Cable



HDMI Cable

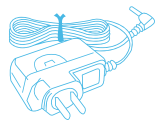

Adapter



Remote

Device Description

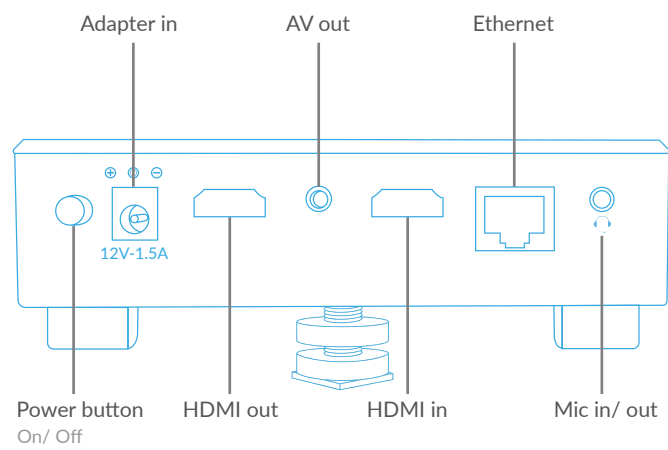

Device Description

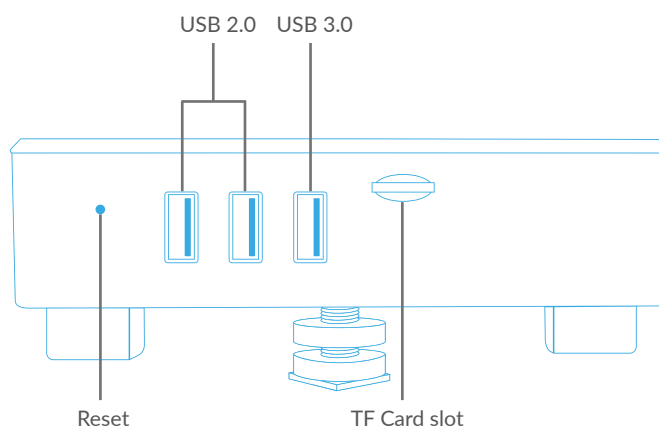

LED Status

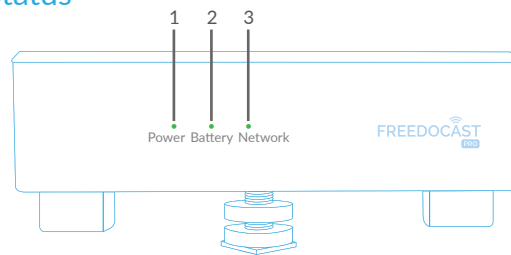

LED Name	Status	LED Color
1. Power	On Standby	<ul style="list-style-type: none"> ● Green ● Red
2. Battery Adapter connected	Fully charged Charging	<ul style="list-style-type: none"> ● Green ● Green blinking
2. Battery Adapter not connected	above 40% below 40% , above 20% below 20%	<ul style="list-style-type: none"> ● Green ● Red ● Red blinking
3. Network	Connected Streaming Not connected Device booting	<ul style="list-style-type: none"> ● Green ● Green blinking ● Red ● Red blinking

Go Live with Freedocast Pro

1. Create a Freedocast account	9
2. Register your Device	9
3. Download Freedocast Pro App	11
4. Configure your Device	12
5. Connect Device to App (Android/ IOS)	13-16
6. Start a Live broadcast	18

1. Create a Freedocast account

Register/ Login to your Freedocast account at www.freedocast.com

2. Register your Device

- a. Go to Dashboard >> Device Management & click on [Add Device](#)
- b. Now enter the Box ID (a six digit alpha-numeric code visible at the back of device) & click on [Next](#)

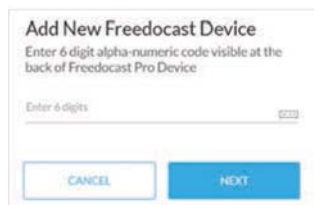
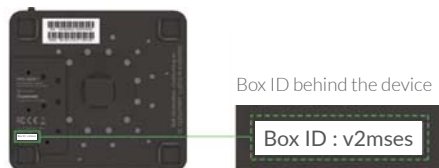

Add New Freedocast Device
Enter 6 digit alpha-numeric code visible at the back of Freedocast Pro Device

Enter 6 digits

The screenshot shows a web form titled 'Add New Freedocast Device'. It contains a text input field with the placeholder text 'Enter 6 digits' and a 'NEXT' button. Below the input field are two buttons: 'CANCEL' and 'NEXT'.

Enter Box ID and click on Next

c. Enter a name for the Device & Click [Next](#) to get the [Pairing ID](#)

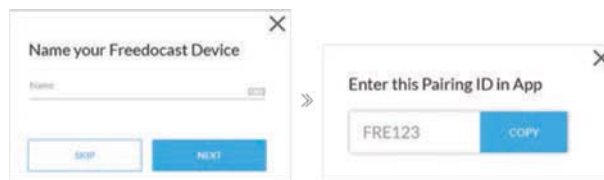

Enter Device Name

Pairing ID

Note : [Pairing ID](#) will be used to connect [Freedocast Pro App](#) to Device

3. Download Freedocast Pro App

Freedocast Pro App enables you to control the Freedocast Pro device & start Live broadcasting



Broadcast simultaneously to multiple platforms like FB Live, YouTube Live, Periscope etc. Provide your users Live HD viewing experience and control the quality easily via remote mobile App

Available on



Android : 4.4+



iOS: 10+

Scan QR



Please have the latest version of the app installed for better performance

4. Configure your Device

- a. Push the Power button to turn on the device

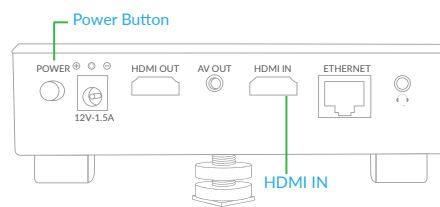

- b. Connect the Camera or Video Source to HDMI-IN

5. A. Connect Device to App | 🤖 Android

Turn on your Device and open the Freedocast Pro app

1. Turn ON Bluetooth on your mobile phone (This is required to pair with Freedocast Device - supports Bluetooth 4.0+)
2. Select your device's box ID & click on [Next](#)



Note : You can tap on [Find more devices](#) to scan for more devices

3. Enter the Pairing ID (provided to you at the time of registration)
& click on [Connect](#) (Refer pg10 for Pairing ID)
If you are a new user, tap on New user and register

Entering Pairing ID

Please enter Pairing ID provided at the time of registering Device "7f4wbg"
What is Pairing ID?

Enter your Pairing ID here

Forgot Pairing ID New user register here

Next

d937fs

Forgot Pairing ID

4. Select your mode of connection for the Device & click on [Next](#)

Select your mode of connection for the Device "7f4wbg"

Wi-Fi

Ethernet

Next

Wi-Fi

Ethernet

(a) [Wi-Fi](#)

Enter the wifi password

(b) [Ethernet](#)

Note : Your device will act like a hotspot

5. You are successfully connected to your Freedocast Pro device

5.B. Connect Device to App | iOS

Turn on your Device and open the Freedocast Pro app

Note: Your Freedocast device has created a temporary hotspot, Connect to it by following the instructions given below.

1. Go to your iPhone settings >Wi-Fi
2. Connect to the hotspot prompted by the Freedocast Pro device.
Example : FCP_<Box ID> | Hotspot password : 00000000



Note : Refer pg 9 for Box ID

3. Go back to the App and now select the device's box ID that you own & click on [Next](#)

Incase your box is not visible refer pg 17

4. Select your mode of connection by tapping on
(a) Wi-Fi (b) Ethernet



5. Enter the Pairing ID & click on **CONNECT**
(Refer pg10 for Pairing ID)



6. You are successfully connected to your Freedocast Pro device

Check Device Wi-Fi status

1. To know your Device Wi-Fi network click on “Check Device Wi-Fi status”

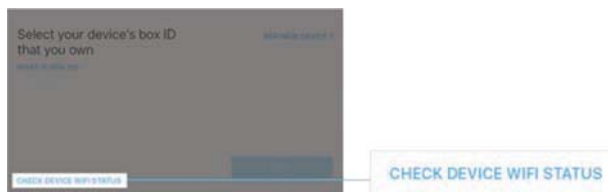

2. Enter your Box ID and click on [Next](#) (Refer pg no 9 for Box ID)
3. Follow the onscreen instructions to get connected with the Device

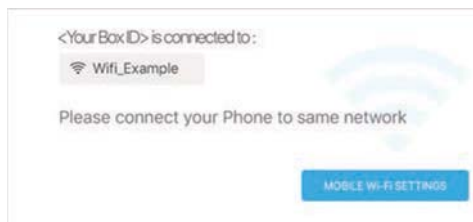

6. Start a Live broadcast

Make sure your Freedocast Device is connected to a Camera or video source through HDMI IN (refer pg no 12)

Open Freedocast Pro app and select your device on which you want to Go Live (refer pg13-Android | pg15- iOS)

1. Select the event which you want to broadcast Live
(Create event if it's not created already)
2. Select your platforms and click on [Next](#)
3. Enter video title - Go Live

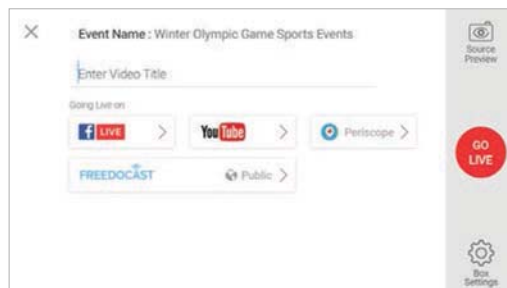

Encoder specifications

Video Encoder

Items	Specifications
Standard	H.264
Resolutions	320X240 TO 1920X1080
Bitrates	100 Kbps to 10 Mbps
Profiles	Baseline, Main and High

Audio encoder

Items	Specifications
Standard	AAC-LC
Sample Frequency	32, 44.1 and 48 kHz when digitized from analog source
Channels	2 channels Stereo (L/R)
Bitrates	32 Kbps to 256 Kbps

Battery specifications

Battery Pack IHO-4000 I

Items	Specifications
Type	Rechargeable lithium-ion battery
Nominal Voltage	7.2V DC
Nominal Capacity	3.6 V 2600 mAh
Impedance	≤220mΩ
Charging Cycles	Approx.400 times
Operating Temperatures	0~60°C
Storage temperature	≤1 month -20~45°C
	≤3 months 0~30°C
	≤1 year 15~25°C
Battery weight	90 grams

Note : Battery life and charging time varies as per operating conditions

Battery Charger - SY6912 Main Board Built-in

Items	Specifications
Rated Input	12V DC,1.5A
Rated Output	8.4V DC,1.25A
Charging Time	Approx. 5~6 hrs
Operating Temperatures	0~40°C

Power Adapter specifications

Compact Power Adapter

India : GSCI1500S012V18H/RJ-AS120150N102 US : GSCU1500S012V18N

Items	Specifications
Rated Input	90-270V AC(50/60Hz) 0.5A
Rated Output	12V DC,1.5A
Operating Temperatures	0-45°C

Certificate



FCC ID(2AIFQIHO-4000I)



CE ID(SZEM1604002782CRV)



BIS ID(R- 41000590)

Warranty

Changes or modifications not expressly approved by the party responsible for compliance could void the user's authority to operate the equipment.

This equipment has been tested and found to comply with the limits for a Class B digital device, pursuant to Part 15 of the FCC Rules. These limits are designed to provide reasonable protection against harmful interference in a residential installation. This equipment generates, uses and can radiate radio frequency energy and, if not installed and used in accordance with the instructions, may cause harmful interference to radio communications. However, there is no guarantee that interference will not occur in a particular installation.

If this equipment does cause harmful interference to radio or television reception, which can be determined by turning the equipment off and on, the user is encouraged to try to correct the interference by one or more of the following measures:

- Reorient or relocate the receiving antenna.
- Increase the separation between the equipment and receiver.
- Connect the equipment into an outlet on a circuit different from that to which the receiver is connected.
- Consult the dealer or an experienced radio/TV technician for help.

This equipment complies with FCC radiation exposure limits set forth for an uncontrolled environment. This equipment should be installed and operated with minimum distance 20cm between the radiator and your body. This transmitter must not be co-located or operating in conjunction with any other antenna or transmitter.

Battery model

It is as per Battery Manufacturer. Warranty period is for 12 months starting from the date of manufacture

Liability

The user has to operate as per the specification "Lithium-ion Rechargeable Battery Specification" published by Shenzhen 3SUN Electronics Co.,LTD. In case the battery were overheated or even catches fire or explosion caused by non compliance of standard operating practice and technical specification or mishandling by the user, YuppTV or the battery manufacturer will not be liable for the loss or damage caused in such accidents.

Device Software update

In case a latest software version is available, it will either trigger the update automatically on switching ON or rebooting your device or on accepting the update request in the Freedocast Pro App. Software update progress is displayed as a pop up in your Freedocast Pro App.

www.freedocast.com