

# User Manual

Broadband ADSL2+ Modem Router

## WBMR-HP-GNV2

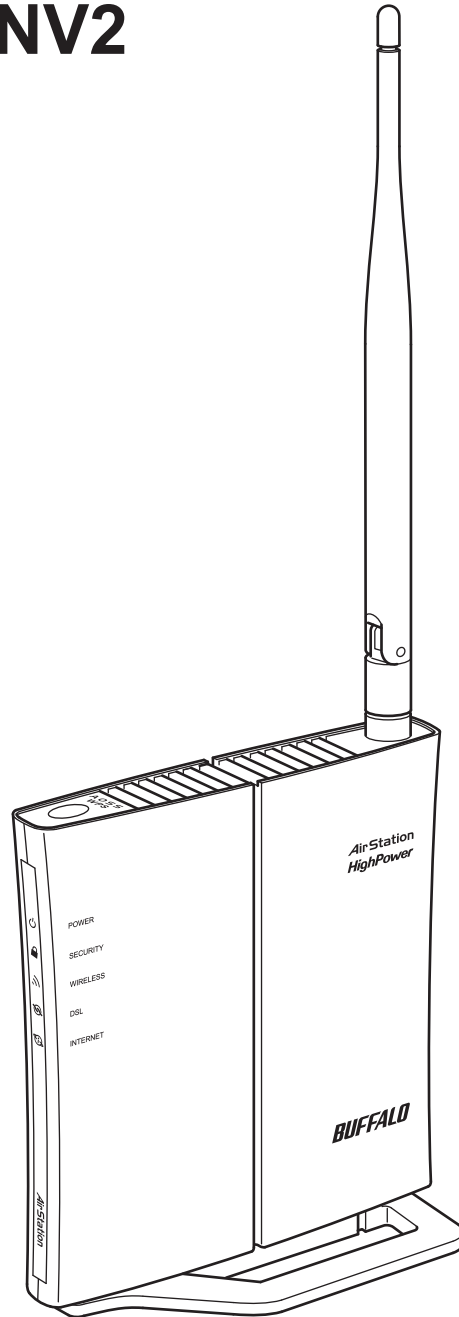

# Contents

<b>Chapter 1 - Product Overview .....</b>	<b>5</b>
Features .....	5
Air Navigator CD Requirements .....	6
150 Mbps High Speed Mode.....	6
Package Contents.....	6
Hardware Overview.....	7
Front Panel LEDs / Back Panel .....	7
Top .....	9
Bottom.....	10
Right Side .....	10
<b>Chapter 2 - Placing Your AirStation .....</b>	<b>11</b>
Vertical Placement .....	11
Horizontal Placement.....	12
Wall-Mounting .....	13
<b>Chapter 3 - Installation.....</b>	<b>14</b>
Automatic Setup.....	14
Manual Setup.....	14
Gathering Information .....	17
<b>Chapter 4 - Configuration .....</b>	<b>19</b>
How to Access the Web-Based Configuration Utility.....	19
Configuration Utility Menus .....	21
Setup.....	23
Internet/LAN .....	25
Internet.....	25

DDNS (Router Mode only) .....	29
Route .....	31
Wireless Config .....	32
WPS .....	32
AOSS .....	33
Basic .....	35
Advanced .....	39
WMM .....	40
MAC Filter .....	42
Security (Router Mode only) .....	43
Firewall (Router Mode only) .....	43
IP Filter (Router Mode only) .....	44
VPN Pass Through (Router Mode only) .....	45
LAN Config .....	46
Port Forwarding (Router Mode only) .....	46
DMZ (Router Mode only) .....	48
UPnP (Router Mode only) .....	48
QoS (Router Mode only) .....	49
Admin Config .....	50
Name .....	50
Password .....	51
Time/Date .....	52
NTP .....	53
ECO .....	54
Access .....	56
Log .....	57
Save/Restore .....	58
Initialize/Restart .....	59
Update .....	60
Diagnostic .....	61
System Info .....	61
Logs .....	63
Packet Info .....	64

Client Monitor .....	65
Ping .....	66
DSL Connection.....	67

## **Chapter 5 - Connect to a Wireless Network ..... 68**

---

Automatic Secure Setup (AOSS/WPS).....	68
Windows 7/Vista (Client Manager V) .....	69
Windows XP (Client Manager 3).....	70
Other Devices (e.g. Game Console).....	70
Manual Setup .....	71
Windows 7 (WLAN AutoConfig).....	71
Windows Vista (WLAN AutoConfig) .....	72
Windows XP (Wireless Zero Configuration).....	75
Mac OS X (AirPort) .....	76

## **Chapter 6 - Trouble Shooting ..... 77**

---

Cannot connect to the Internet over wired connection.....	77
Cannot access the web-based configuration utility. ....	77
Cannot connect to the network wirelessly.....	78
You forgot AirStation's SSID, Encryption Key, or Password....	78
The link speed is slower than 150 Mbps (Maximum link speed is only 65 Mbps).....	78
Other Tips.....	79

## **Appendix A - Specifications ..... 81**

---

## **Appendix B - Default Configuration Settings ..... 82**

---

<b>Appendix C - TCP/IP Settings.....</b>	<b>87</b>
Windows 7.....	87
Windows Vista.....	88
Windows XP.....	89
Mac OS X.....	90
<b>Appendix D - Restoring the Default Configuration .....</b>	<b>91</b>
<b>Appendix E - Regulatory Compliance Information.....</b>	<b>92</b>
<b>Appendix F - Environmental Information .....</b>	<b>96</b>
<b>Appendix G - GPL Information .....</b>	<b>97</b>
<b>Appendix H - Warranty Information .....</b>	<b>98</b>

# Chapter 1 - Product Overview

## Features

---

### **Supports IEEE802.11n and IEEE802.11b/g**

With support for current Wireless-N, Wireless-G, and Wireless-B standards, the AirStation can transfer data to and from all standard 2.4 GHz wireless clients.

### **Dual speed mode**

Dual speed mode makes wireless transmission faster by using 2 channels, allowing 150 Mbps data transmission.

### **Support AOSS and WPS**

Both AOSS (AirStation One-touch Secure System) and WPS (Wi-Fi Protected Setup) are supported. These automatic connection standards make connection with compatible wireless devices easier.

### **Security Features**

The AirStation is equipped with following security features:

- AOSS
- WPS
- WPA-PSK (TKIP/AES)
- WPA2-PSK(TKIP/AES)
- WPA/WPA2 mixed PSK
- WEP(128-bit and 64-bit)
- Privacy Separator
- MAC address access restriction
- Deny Any Connection/SSID stealth feature
- Setting screen with password
- Firewall feature with easy rules

### **Automatic Channel Selection**

Monitors wireless interference and automatically assigns the clearest, best channel.

### **Initialization**

To restore settings back to the factory defaults, hold down the Reset button on the bottom of the unit.

### **Browser Based Administration**

This unit can be easily configured from a web browser on your computer.

## Air Navigator CD Requirements

---

The AirStation wireless router and access point works with most wired and wireless devices. However, the automatic installation program on the CD requires a connected Windows 7, Vista or XP computer to run. If you use the AirStation with a different operating system, you will have to configure your network settings manually from a browser window.

## 150 Mbps High Speed Mode

---

150 Mbps is the link speed when using Wireless-N mode. It represents actual wireless data speeds, including overhead. Because the overhead is not available for user data transfer, usable wireless throughput will be substantially slower.

## Package Contents

---

The following items are included in your AirStation package. If any of the items are missing, please contact your vender.

- WBMR-HP-GNV2..... 1
- Detachable antenna..... 1
- AC adapter ..... 1
- Stand for vertical/horizontal/wall-mounting..... 1
- Screws for wall-mounting ..... 2
- LAN cable ..... 1
- DSL cable..... 1
- Air Navigator CD..... 1
- Quick Setup Guide..... 1

# Hardware Overview

## Front Panel LEDs / Back Panel

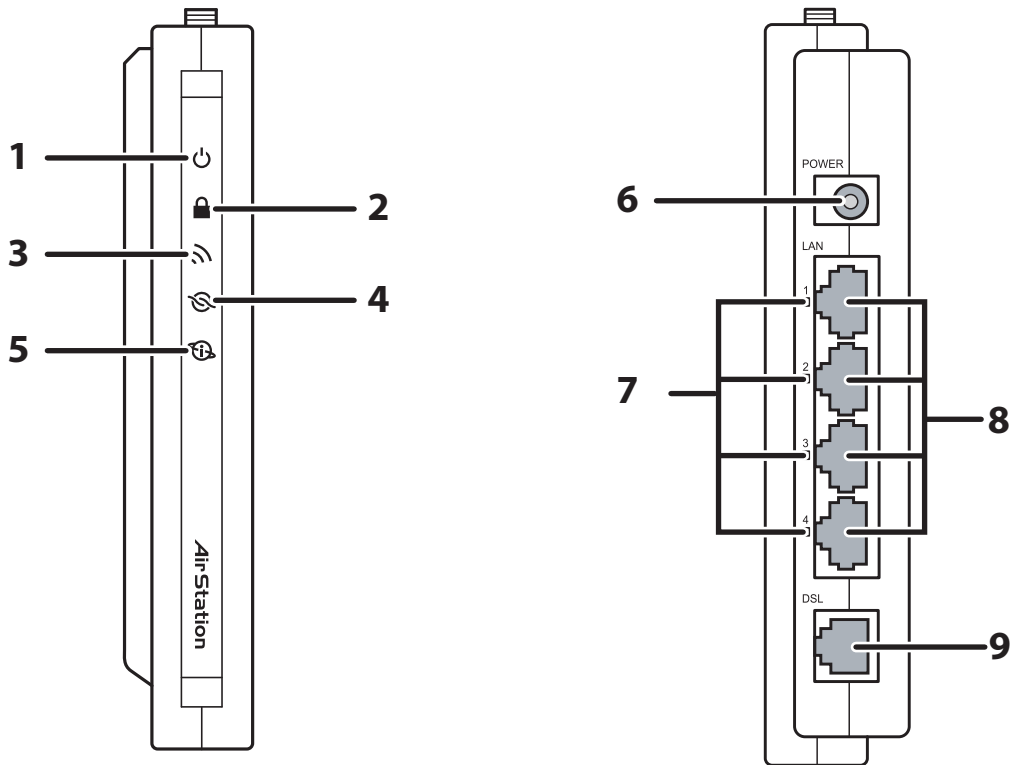

### 1 Power LED

On (Green) : The AC adapter is connected.

Off (Green) : The AC adapter is not connected.

Shows AirStation status.

2 blinks (Red) <sup>\*1</sup> : Flash ROM error.

3 blinks (Red) <sup>\*1</sup> : Wired Ethernet LAN error.

4 blinks (Red) <sup>\*1</sup> : Wireless LAN error.

5 blinks (Red) <sup>\*1</sup> : Network error.

9 blinks (Red) <sup>\*1</sup> : System error.

Continuously Updating firmware, saving settings, or initializing settings.

blinking (Red) <sup>\*2</sup> :



- \*1 Turn off AirStation first, wait for a few seconds, then turn it back on.
- \*2 If the Power LED keeps blinking, do not turn off the AirStation nor unplug its power cable.

## **2 Security LED (Amber)**

Indicates security status.

- Off : AOSS or Encryption is not set.
- On : AOSS/WPS activated; accessed to exchange security keys.  
Encryption has been set.
- 2 blinks : The unit is waiting for an AOSS or WPS security key.
- Blinking : AOSS/WPS error; failed to exchange security keys.
- Note : The Security LED is lit if an encryption key has been set.

## **3 Wireless LED (Green)**

Indicates wireless LAN status.

- On : Wireless LAN is transmitting.
- Off : Wireless LAN is not active.

## **4 DSL LED (Green)**

Indicates DSL status.

- On : The DSL port is connected.

## **5 Internet LED**

Indicates Internet status.

- On (Green) : Connected to Internet
- Blinking (Green) : Communicating over Internet
- On (Red) : Not connected to Internet
- Off : Operating in bridge mode

## **6 DC Connector**

Connect the included AC adapter here.

## **7 LAN LED (Green)**

- On : An Ethernet device is connected.
- Blinking : An Ethernet device is communicating.

## **8 LAN Port**

Connect your computer, hub, or other Ethernet devices to these ports. This switching hub supports 10 Mbps, 100 Mbps connections.

## **9 DSL Port**

Connect your ADSL line to this port.

## Top

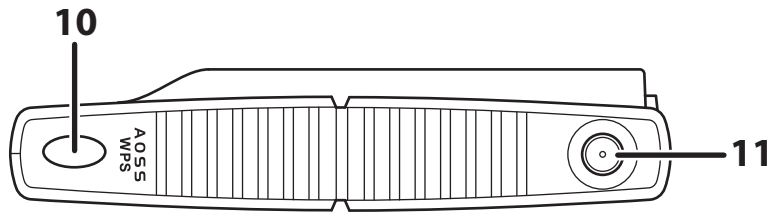

**10 AOSS Button** To initiate AOSS, hold down this button until the Security LED flashes (about 1 second). Then, push or click the AOSS button on your wireless client device to complete the connection. Both devices must be powered on for this to work.

**11 Antenna connector** Screw on the antenna here.

## Bottom

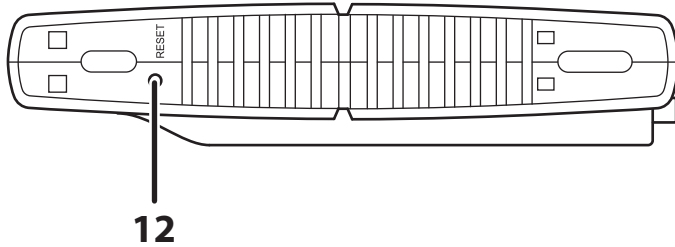

### 12 Reset Button

To reset all settings, hold down this button until the Power LED comes on (about 3 seconds). Power must be on.

## Right Side

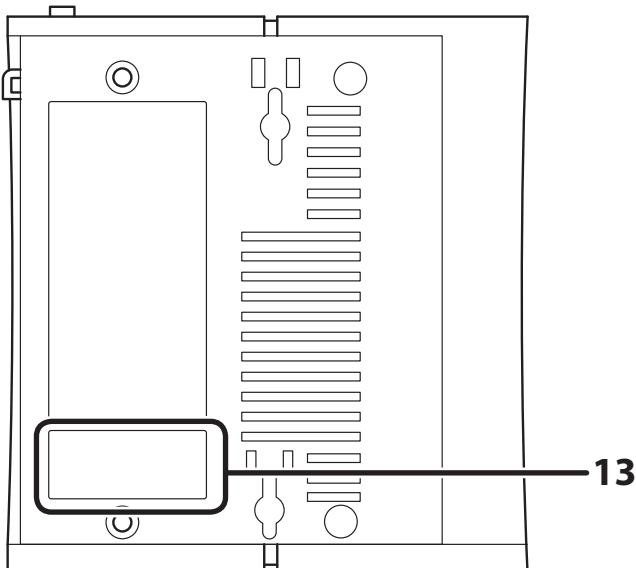

### 13 Factory Default Settings

This sticker shows the AirStation's SSID, default encryption key, and WPS PIN code. By default, encryption is disabled for AirStations sold in Asia Pacific.

# Chapter 2 - Placing Your AirStation

## Antenna Placement

---

The antenna is included in the package. Screw the antenna clockwise to install.

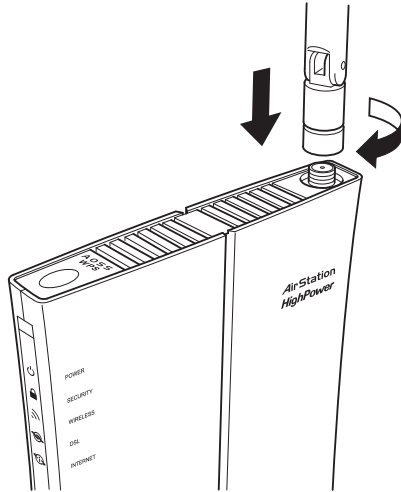

## Vertical Placement

---

To place unit vertically, attach the stand as shown below.

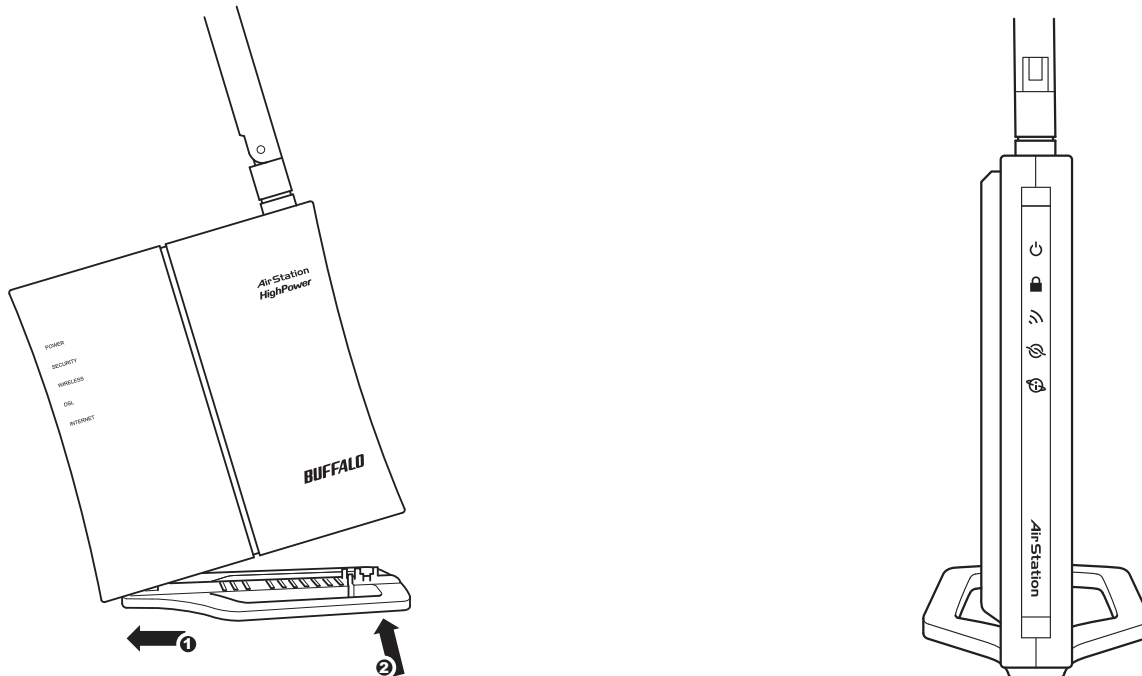

## Horizontal Placement

---

For horizontal placement, the stand is not used.

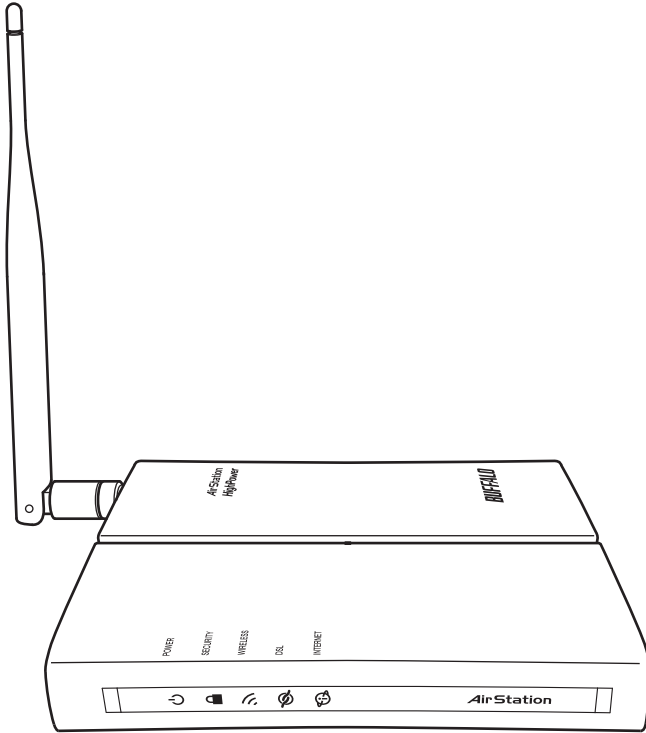

## Wall-Mounting

---

**1**

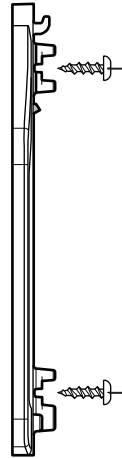
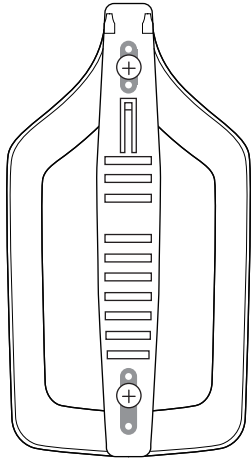

To wall-mount the AirStation, attach the stand to the wall with the two screws (included).

8.5 cm  
(~3.3 inches)

**2**

Snap the center of the AirStation to the stand as shown.

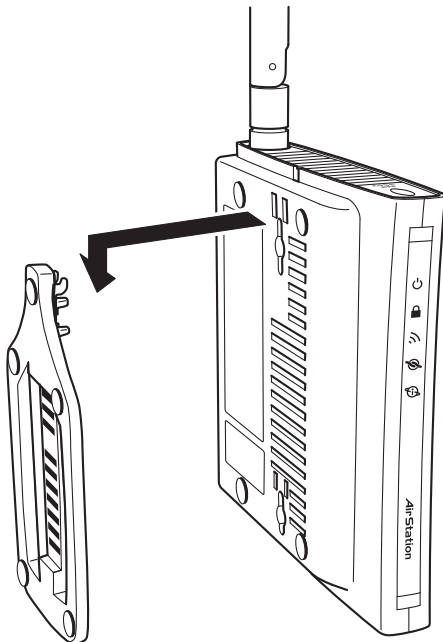

# Chapter 3 - Installation

## Automatic Setup

---

The AirNavigator CD can step you through installing your AirStation. To step through the setup program, insert the CD into your Windows 7/Vista/XP PC and follow the instructions on the screen. If your computer uses a different operating system, use manual setup instead.

- Note:**
- **To use a wireless client in Windows 7 or Vista, perform setup using the AirNavigator CD to automatically generate a profile for wirelessly connecting to the AirStation. After setup is complete, once the LAN cable is removed, you can connect from your wireless client to the AirStation.**
  - **Before performing setup, make the settings to enable the wireless client of the computer.**

## Manual Setup

---

To configure your AirStation manually, follow the procedure below.

- 1** Power off your computers and networking equipment.
- 2** Connect your computer to one of the LAN ports on the rear of the AirStation with the supplied Ethernet network cable.

**3** Connection for the AirStation to the ADSL line varies by country and region. Typically it involves a microfilter or a microfilter with built-in splitter to allow simultaneous use of ADSL service and telephone service on the same telephone line. Please read the following steps carefully and select the appropriate method.

- If your telephone service and ADSL service are on the same telephone line, ADSL microfilters are needed for each telephone and device, such as answering machine, fax machine, and caller ID display. Additional splitters may be used to separate telephone lines for telephone and Router.

Note: Do not connect the ADSL microfilter between the wall jack and the Router—this will prevent ADSL service from reaching the modem.

- If your telephone service and ADSL service are on the same telephone line and you are using an ADSL microfilter with built-in splitter, connect the splitter to the telephone wall jack providing ADSL service. Then, connect the telephone cord from the ADSL microfilter RJ11 port generally labelled 'DSL' to the gray RJ11 port labelled 'DSL line' on the back of your Router. Connect the telephony device to the other port on the ADSL splitter commonly labelled 'Phone'.

Note: An RJ11 telephone cord is supplied. When inserting an RJ11 plug, be sure the tab on the plug clicks into position correctly.

- If you have a dedicated ADSL service telephone line with an RJ11 wall jack, simply connect a telephone cord from the wall jack to the DSL port on the back of the AirStation.
- If you have an RJ45 wall jack for your ADSL service, connect an RJ45-to-RJ11 converter to the wall jack. Then connect one end of the telephone cord to the converter and the other end to the DSL port on the back of the AirStation.

**4** Connect your computer to one of the AirStation's LAN ports with the LAN cable.

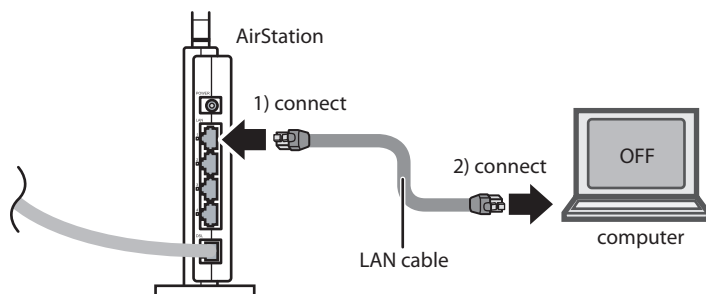



**5** Turn on the AirStation, wait one minute, and then turn on your computer.

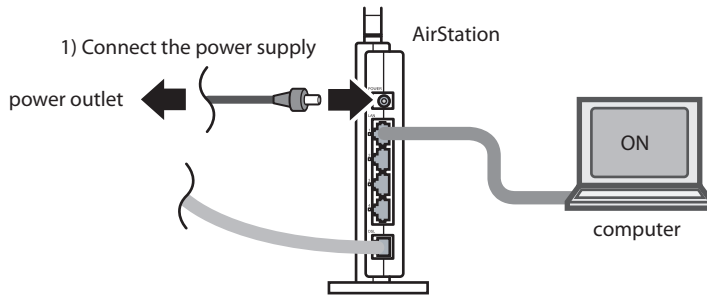

**6** Once your computer has booted, the AirStation's LEDs should be lit as described below:

POWER	Green light on.
WIRELESS	Green light on or blinking.
DSL	Green light on or off depending on your network.
INTERNET	Green light on.
LAN	Green light on or blinking.

For LED locations, refer to chapter 1.

**7** Launch a web browser. If the [home] setup screen is displayed, setup is complete. If a user name and password screen is displayed, enter [root] (in lower case) for the user name, leave the password blank, and click [OK]. Step through the wizard to complete setup. You've completed initial setup of your AirStation. Refer to Chapter 4 for advanced settings.

## Gathering Information

---

Most DSL providers require PPPoE or PPPoA details to log in to your connection. You must call your ISP's Technical Support number to obtain the following information:

**Username :** This is the Username that is used to log onto your ADSL service provider's network. It is commonly in the form – user@isp.com.

**Password :** This is the Password that is used, in conjunction with the Username above, to log on to your ADSL service provider's network.

**Connection Protocol :** This is the method that your ADSL service provider uses to send and receive data between the Internet and your computer.

**VPI :** This is the Virtual Path Identifier (VPI). It is used in conjunction with the Virtual Channel Identifier (VCI) below, to identify the data path between your ADSL service provider's network and your computer.

**VCI :** This is the Virtual Channel Identifier (VCI). It is used in conjunction with the VPI above to identify the data path between your ADSL service provider's network and your computer.

**Note :** This information should be stored and kept to hand as it will be required to enable you to establish an internet connection.

The table below is a quick reference guide for configuring your ADSL Internet connection. You may try the settings for the ISPs shown.

---

<b>Country</b>	<b>Encapsulation</b>	<b>VPI / VCI</b>	<b>Multi plexing</b>	<b>ISPs</b>
France	RFC2516 PPPoE	8/35	LLC	Various
	RFC2516 PPPoE	8/67	LLC	
	RFC2364 PPPoA	8/35	VC	
Germany	RFC2516 PPPoE	1/32	LLC	T-Online, Various

<b>Country</b>	<b>Encapsulation</b>	<b>VPI / VCI</b>	<b>Multi plexing</b>	<b>ISPs</b>
Holland	RFC1483 Bridged	0/35 0/32 0/34	LLC	BBNed, XS4all Versatel, DHCP Baby XL, Tiscali. (start/Surf/ Family/Live)
	RFC2364 PPPoA	8/48	VC	KPN, Hetnet, HCCNet, Tiscali (lite/ Basis/Plus), Wanadoo
	RFC2364 PPPoA	0/32	VC	Versatel PPP, Zonnet
	RFC2516 PPPoE	8/35	LLC	Various
Belgium	RFC2364 PPPoA	8/35	LLC	Belgacom, Tiscali, Scarlet
Ireland	RFC2516 PPPoE	8/35	LLC	Eircom, BT, Digiweb, Irish Broadband
Italy	RFC2516 PPPoE	8/35	VC	TIN
Spain	RFC2516 PPPoE	8/32	LLC	Telefonica
Sweden	RFC1483 Bridged	3/35	LLC	Telia
UK	RFC2364 PPPoA	0/38	VC	BT, Freeserve, Tiscali, AOL

# Chapter 4 - Configuration

The web-based configuration tool lets you change advanced settings for the AirStation. Don't change these settings unless you know what you're doing.

## How to Access the Web-Based Configuration Utility

To configure the AirStation's advanced settings manually, log in to the web-based configuration utility as shown below.

**1** Launch a web browser.

**2**

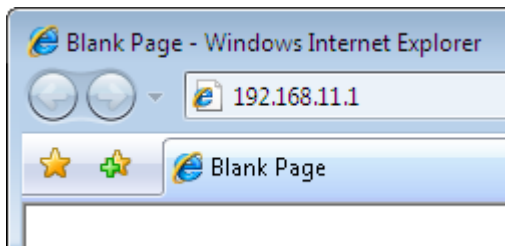

Enter the AirStation's LAN-side IP address in the address field, and press the [Enter] key.

Note:

- The AirStation's default LAN-side IP address is 192.168.11.1.
- If you changed the IP address of the AirStation, then use the new IP address.

**3**

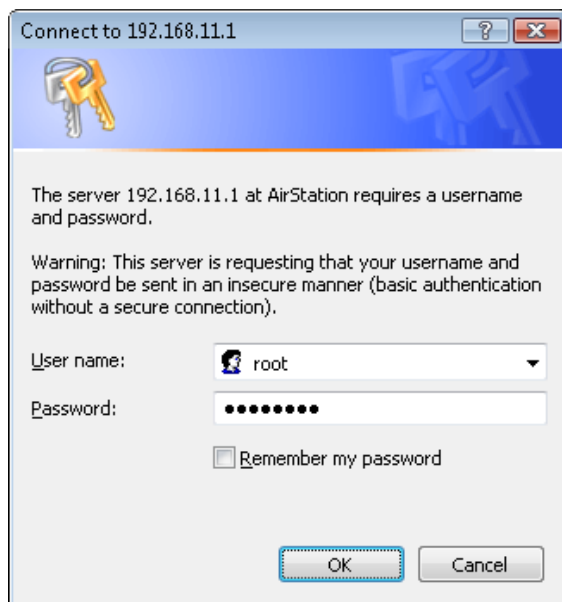

When this screen appears, enter [root] (in lower case) for the user name and the password that you set during initial setup. Click [OK].

Note:

- By default, the password is blank (not set).
- If you forget your password, hold down the Reset button (page 10) to initialize all settings. The password will then be blank. Note that all other settings will also revert to their default values.

4

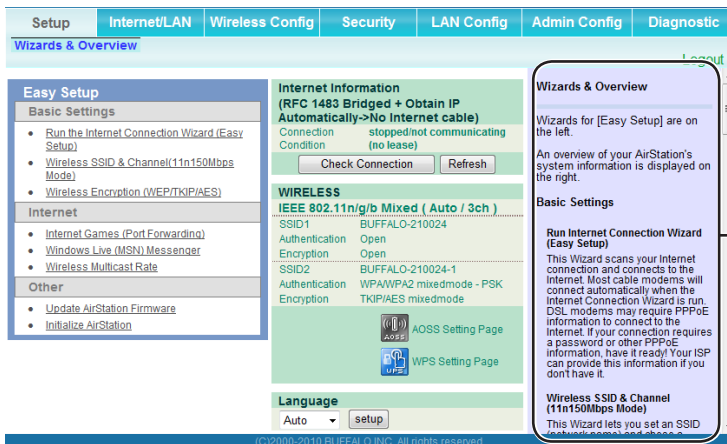

This is the configuration utility, where most AirStation settings can be configured.

Help is always displayed on the right side of each screen. Refer to the Help screens for more information on using the configuration utility.

## Configuration Utility Menus

The menu structure for the AirStation is as follows. Please refer to the pages listed at right for explanations of each item.

Main screen	Descriptions	Page
<b>Internet/LAN</b>		
Internet	Configure Internet settings.	Page 25
DDNS	DNS settings.	Page 29
Route	Configure the AirStation's IP communication route.	Page 31
<b>Wireless Config</b>		
WPS	WPS settings and status.	Page 32
AOSS	AOSS (AirStation One-touch Secure System) settings and status.	Page 33
Basic	Configure basic wireless settings.	Page 35
Advanced	Configure advanced wireless settings.	Page 39
WMM	Set priorities for Wireless Multimedia Extensions (Wi-Fi Multimedia).	Page 40
MAC Filter	Limit access to specific devices.	Page 42
<b>Security</b>		
Firewall	Protect your computer from outside intruders.	Page 43
IP Filter	IP filters for packets passing through the LAN side and the Internet side.	Page 44
VPN Passthrough	Configure IPv6 passthrough, PPPoE passthrough, and PPTP passthrough.	Page 45
<b>LAN Config</b>		
Port Forwarding	Configure port translation and exceptions for games and other programs.	Page 46
DMZ	Configure a destination to transfer communication packets without a LAN side destination.	Page 48
UPnP	Configure UPnP (Universal Plug and Play).	Page 48
QoS	Configure priority for packets that require a guaranteed data flow.	Page 49
<b>Admin Config</b>		
Name	Configure the AirStation's name.	Page 50
Password	Configure the AirStation's login password for access to the configuration utility.	Page 51
Time/Date	Configure the AirStation's internal clock.	Page 52
NTP	Configure the AirStation to synchronize with an NTP server to automatically set the AirStation's internal clock.	Page 53
ECO	Configure the AirStation's ECO Mode.	Page 54

Access	Configure access restrictions to the AirStation's configuration screens.	Page 56
Log	Configure a syslog server to manage the AirStation's logs.	Page 57
Save/Restore	Save or restore the AirStation's configuration from a configuration file.	Page 58
Initialize/Restart	Initialize the AirStation or reboot it.	Page 59
Update	Update the AirStation's firmware.	Page 60
Diagnostic		
System Info	View current system information for the AirStation.	Page 61
Logs	Check the AirStation's logs.	Page 63
Packet Info	View all packets transferred by the AirStation.	Page 64
Client Monitor	View all devices currently connected to the AirStation.	Page 65
Ping	Test the AirStation's connection to other devices on the network.	Page 66
DSL Connection	View DSL Connection for the AirStation.	Page 67
Logout		
Click this to log out of the AirStation's configuration screens.		

# Setup

Setup is the home page of the configuration utility. You can verify settings and the status of the AirStation here.

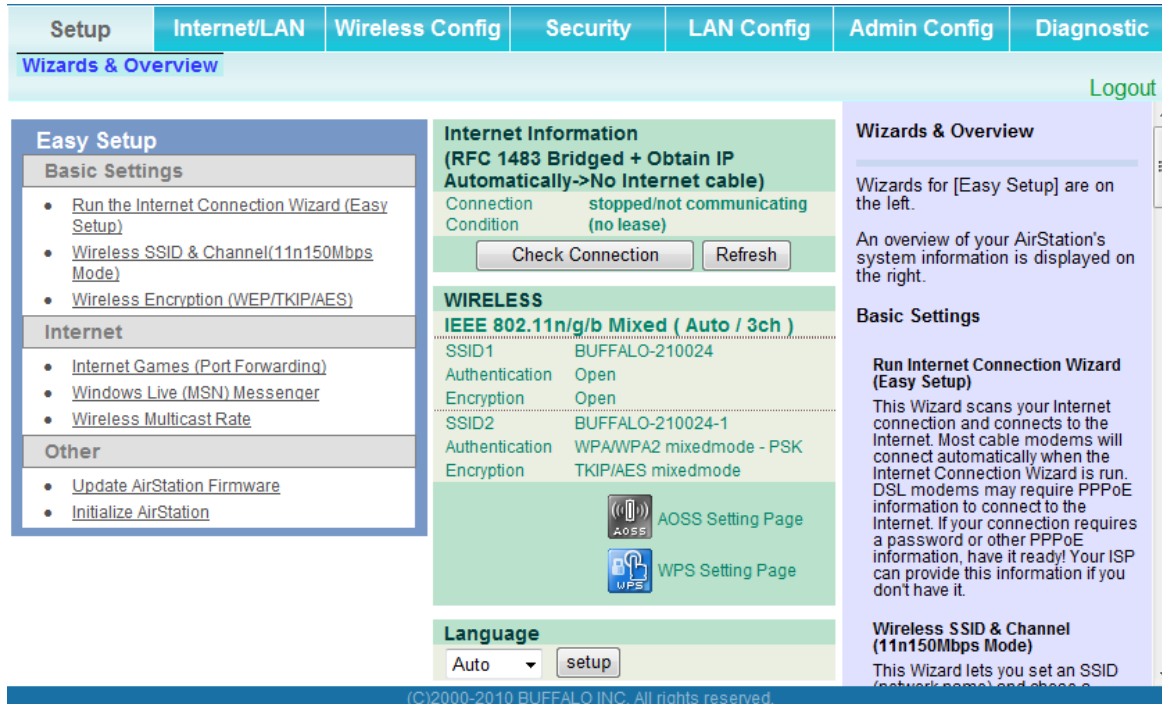

Parameter	Meaning
Internet/LAN (LAN Config)	Displays the configuration screen for the Internet port and LAN ports.
Wireless Config	Click this button to display the configuration screen for wireless settings.
Security	Click this button to display the configuration screen for security.
LAN Config	Click this button to display the configuration screen to open ports for games and applications.
Admin Config	Click this button to display the configuration screen for administration settings.
Diagnostic	Click this button to display the status of the AirStation.
Easy Setup	Enables you to easily configure the AirStation's network settings automatically.
Internet Information	Displays WAN-side system information for the AirStation.



---

<b>Parameter</b>	<b>Meaning</b>
WIRELESS	Displays the current wireless settings.
AOSS Setup	Click this button to display the AOSS configuration screen.
WPS Setup	Click this button to display the WPS configuration screen.
Language	Enables you to select the language you use.
Logout	Log out from the configuration screen of the AirStation. If the AirStation does not communicate for 5 minutes, it will log out automatically.

---

# Internet/LAN

## Internet

The Internet settings are made here. For details on the settings, refer to the documentation provided by your ADSL provider.

The screenshot shows a web-based configuration interface for Internet settings. At the top, there are navigation tabs: Setup, Internet/LAN (selected), Wireless Config, Security, LAN Config, Admin Config, and Diagnostic. Below the tabs, there are sub-tabs: Internet, DDNS, and Route. A 'Logout' link is visible in the top right corner.

**Internet Setup**

**Internet Connection Type**

Encapsulation: RFC 1483 Bridged

**DSL Settings**

Modulation: MultiMode

**VC Settings**

Multiplexing:  LLC  VC

QoS Type: UBR

PCR Rate: 0 cps

SCR Rate: 0 cps

Auto Detect:  Enable  Disable

Virtual Circuit: VPI (Range 0-255): 0, VCI (Range 32-65535): 35

**IP Settings**

Obtain an IP Address Automatically

Use the following IP Address:

Internet IP Address: 0.0.0.0

Subnet Mask: 0.0.0.0

Gateway: 0.0.0.0

Primary DNS: 0.0.0.0

Second DNS: 0.0.0.0

**Optional Settings(required by some ISPs)**

Host Name:

Domain Name:

MTU: Auto

Size: 1500

**Network Setup**

Local IP Address: 192.168.11.1

Subnet Mask: 255.255.255.0

**Network Address Server Settings (DHCP)**

Local DHCP Server:  Enable  Disable  DHCP Relay

DHCP Relay Server: 0.0.0.0 [Advanced]

Starting IP Address: 192.168.11.64

Maximum Number of DHCP Users: 191

Client Lease Time: 2880 minutes (0 means two days)

Static DNS 1: 0.0.0.0

Static DNS 2: 0.0.0.0

Static DNS 3: 0.0.0.0

WINS: 0.0.0.0

[Apply]

**Internet Setup**

The Internet Setup section is for setting your broadband gateway to work correctly with your ISP's equipment. This includes your ISP's Internet servers and the Asynchronous Transfer Mode (ATM) network between the gateway and the servers.

Information on what settings to use in this section must be obtained from your ISP.

**Internet Connection Type**

**Encapsulation**

Encapsulation is the protocol used between your broadband gateway and your ISP's servers. Most of the encapsulations are defined in Internet standards called Requests for Comments (RFCs). Two are derived from the Point-to-Point Protocol (PPP): PPP over Ethernet (PPPoE) and PPP over ATM (PPPoA).

**DSL Settings**

**Modulation**

Select a proper DSL protocol from the drop-down menu. The default DSL protocol is set to MultiMode, which supports automatic negotiation with DSLAM. It is suggested the using of MultiMode unless you are required to specify a particular DSL protocol, in that case, then select one of the list.

**VC Settings**

**Multiplexing**

Select the method used to route different kinds of data through different virtual circuits (VCs) in the ATM network: Logical Link Control (LLC) encapsulation (also called LLC-SNAP) or Virtual Channel (VC) multiplexing (also called VC-Mux).

**QoS Type**

Select the Quality of Service (QoS) method your ISP uses on your line: Unspecified Bit Rate (UBR), Constant Bit Rate (CBR), or Variable Bit Rate (VBR). CBR provides the best guarantee of low latency; UBR provides none.

**PCR Rate**

When QoS is set to CBR or VBR, the Peak Cell Rate (PCR) in cells per second must be entered here.

**SCR Rate**

When QoS is set to VBR, the Sustained Cell Rate (SCR) in cells per second must be entered here.

**Autodetect**

You can enable or disable automatic detection of the VPI and VCI values (see next) that identify your line to the ATM network.

**Virtual Circuit**

The Virtual Path Identifier (VPI) and Virtual Channel Identifier (VCI) are values used to identify your line to your ISP's ATM network.

©2000-2010 BUFFALO INC. All rights reserved.

Parameter	Meaning
Internet Setup	
Encapsulation	Set the ADSL communication method.
Modulation	Set the modulation system used in ADSL communication.
Multiplexing	Set the encapsulation system for VC multiplexing. Select from LLC (Logical Link Control Encapsulation) which can handle multiple protocols or VC (Virtual Circuit) for a single protocol.
QoS Type	Set the QoS (Quality of Service). Select from the three service categories (UBR, CBR, VBR) where the QoS is guaranteed in the band.
PCR Rate	Set the PCR (Peak Cell Rate) when CBR or VBR is selected for QoS Type. The network upper limit transfer speed is set in the range from 1 to 65534 cps.
SCR Rate	Set the SCR (Sustainable Cell Rate) when CBR or VBR is selected for QoS Type. The network sustainable transfer speed is set in the range from 1 to 65534 cps.
Auto Detect	Set to VPI (Virtual Path Identification) or VCI (Virtual Channel Identification) of the virtual circuit when Disable is selected for Auto Detect.
Virtual Circuit	Set automatic detection of the virtual circuit.
Obtain an IP Address Automatically(DHCP)/Use following IP Address	This option is displayed when RFC1483 Bridged is selected in the Encapsulation field. Select whether the IP address, subnet mask, gateway, and DNS are obtained automatically or manually.
Internet IP Address	Set the "public" (or "global") IP address that identifies your broadband gateway on the Internet.
Subnet Mask	Set the Internet subnet mask.
Gateway	Set the Gateway address specified by the provider.
Primary DNS / Second DNS	Set the DNS server address specified by the provider.
Service Name	Set the service name specified by the provider in 64 or less single-byte alphanumeric characters.

Parameter	Meaning
User Name	Set the user name (PPP login name) specified by the provider in 64 or less single-byte alphanumeric characters and symbols. If the name specified by the provider contains an @ mark, the characters after the @ mark cannot be omitted when entering the User Name.
Password	Set the password specified by the provider in 64 or less single-byte alphanumeric characters and symbols.
Connect on Demand/Keep Alive	Select the Connect on Demand or Keep Alive. When Connect on Demand is selected, the AirStation is automatically connected to the server only when communication is performed. The connection is disconnected if the communication is not performed for a preset time (disconnect time). Set the disconnect time in the range from 1 to 9999 minutes. When Keep Alive is selected, the AirStation issues an LCP echo request to the server periodically at preset time intervals, and the response received from the server is used to confirm that communication is enabled. If no response from the server is received, the AirStation assumes that the line is disconnected, and it disconnects the connection. Set the Keep Alive time interval in the range from 20 to 180 seconds.
Host Name	Set the host name that is sent to the server when acquiring the IP address from the Internet.
Domain Name	Set the domain name.
MTU	Set the MTU (Maximum Transmission Unit) that is used in communication. Select from Auto or Manual. When set to Manual, the available range is set from 576 to 1500 bytes.
<b>Network Setup</b>	
Local IP Address / Subnet Mask	By default, the LAN side IP address is 192.168.11.1 with subnet mask 255.255.255.0. You may change it here.
Local DHCP Server	The factory setting of this control, Enable, sets the gateway to act as a DHCP server for local machines. When this setting is used, you can set a range of IP addresses to be assigned by DHCP. Addresses outside this range can be assigned manually to machines set to use fixed IP settings.

---

<b>Parameter</b>	<b>Meaning</b>
DHCP Relay Server	When Local DHCP Server is set to DHCP Relay, you must enter the IP address of the remote DHCP server here. (Note that "DHCP relay server" is a widely used but incorrect term for a remote DHCP server.)
Starting IP Address	This is the lowest address in the range that the gateway will assign by DHCP.
Maximum Number of DHCP Users	This is the number of addresses that can be assigned by DHCP.
Client Lease Time	This is the number of minutes any DHCP client is given exclusive use of a (non-reserved) DHCP-assigned IP address. This can be from 1 to 9999.
Static DNS 1 / Static DNS 2 / Static DNS 3	Enter the IP address(es) of one to three name servers.
WINS	Enter the IP address of a Windows Internet Name Service server, if such a server is available to you.

---

## DDNS (Router Mode only)

Configure Dynamic DNS settings. Many settings are only available when the appropriate Dynamic DNS service is enabled.

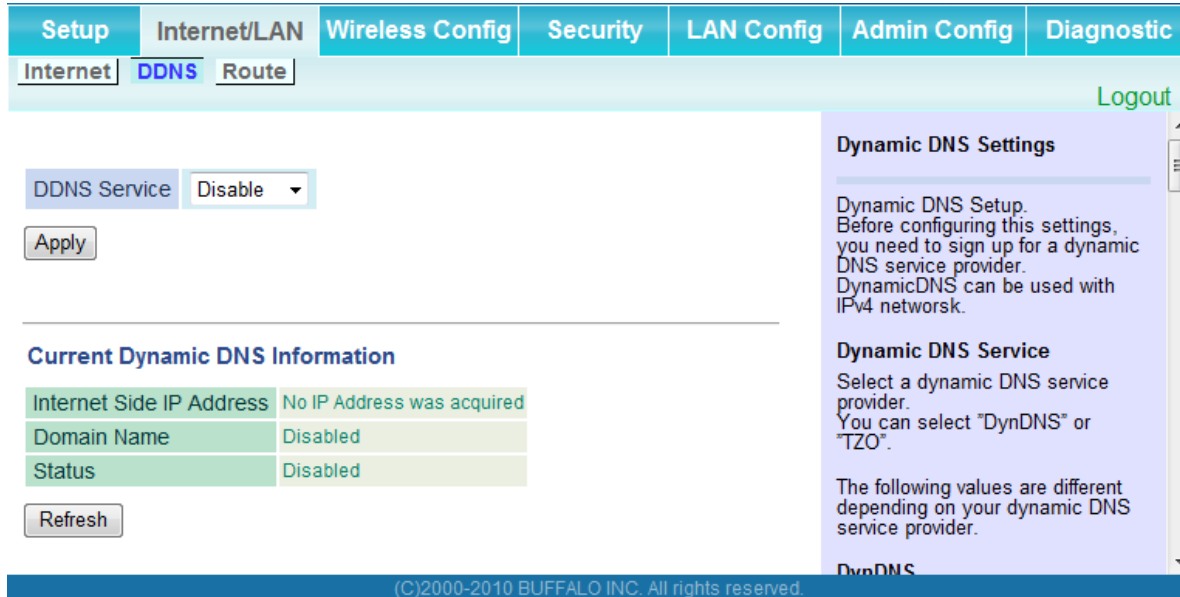

Parameter	Meaning
DDNS Service	Select a provider (DynDNS or TZO) for Dynamic DNS.
User Name	Enter the Dynamic DNS user name. You may enter up to 64 alphanumerical characters and symbols.
Password	Enter the Dynamic DNS password. You may enter up to 64 alphanumerical characters and symbols.
Host Name	Enter the Dynamic DNS host name. You may enter up to 255 alphanumerical characters, hyphens, and periods.
Email Address	Enter the email address which is registered to the Dynamic DNS service. You may enter up to 64 alphanumerical characters and symbols.
TZO Key	Enter the TZO Key which is registered to the Dynamic DNS service. You may enter up to 64 alphanumerical characters and symbols.
Domain Name	Enter the domain name which is registered to the Dynamic DNS service. You may enter up to 255 alphanumerical characters, hyphens, and periods.

---

<b>Parameter</b>	<b>Meaning</b>
IP Address Update Period	Specifies the period to notify the dynamic DNS service provider of the current IP address. For DynDNS, set it between 0 and 35 days. For TZO, set it between 0 and 99 days. If 0 (zero) days is set, no periodic update is performed.
Internet Side IP Address	The WAN-side IP address of the AirStation's Internet port. This address is sent to the dynamic DNS service provider.
Domain Name	The domain name assigned by the dynamic DNS Service provider. The AirStation can be accessed from the Internet using this domain name.
Status	Display the status of dynamic DNS service.

---

## Route

Configure the AirStation’s IP communication route.

Parameter	Meaning
Destination Address	Adds a destination IP address and subnet mask to a routing table.
Gateway	Adds a gateway address to a routing table.
Metric	The metric is the maximum number of router hops a packet may take on the way to its destination address. Values between 1 and 15 may be entered. The default value is 15.
Routing Information	Manual entries will appear here after being added.



# Wireless Config

## WPS

WPS Status and Settings.

Parameter	Meaning
WPS	Enable to use WPS automatic configuration.
External Registrar	Enable to accept the external configure requests from other WPS devices. Note: External configure requests will not be accepted if AOSS is in use.
AirStation PIN	Displays the PIN code of the AirStation. Clicking [Generate PIN] will generate a new PIN code. This code can be entered into other wireless devices that support WPS.
Enrollee PIN	Enter the PIN code for the other wireless device and click [OK].
WPS status	Displays [configured] if all available wireless bands are configured. Displays [unconfigured] if at least one wireless band is unconfigured.

# AOSS

## AOSS Status and Settings.

Setup	Internet/LAN	Wireless Config	Security	LAN Config	Admin Config	Diagnostic
WPS	AOSS	Basic(11n/g/b)	Advanced(11n/g/b)	WMM(11n/g/b)	MAC Filter	

Logout

### AOSS Settings - Edit AOSS Client Information

Encryption Type of Exclusive SSID for WEP	Stop
Advanced Encryption Level feature	Enable
Exclusive SSID for WEP	Disable
AOSS Button on the AirStation Unit	<input checked="" type="checkbox"/> Enable

#### Current Encryption Information 802.11n/g/b

Encryption Type	WPA-PSK-AES (Now in use)		
SSID	BUFFALO-210024-1-1		
Encryption key	wbmrhpgnv8888		
Encryption Type	WPAWPA2-PSK-mixed (Now in use)		
SSID	BUFFALO-210024-1		
Encryption key	wbmrhpgnv8888		
Encryption Type	WEP128		
SSID	BUFFALO-210024-1-3		
Encryption key	545ce18b393496265acc657a8b	(Sending Key)	
	545ce18b393496265acc657a8b		
	545ce18b393496265acc657a8b		
	545ce18b393496265acc657a8b		
Encryption Type	WEP64		
SSID	BUFFALO-210024-1-4		
Encryption key	07af4c6bc8	(Sending Key)	
	07af4c6bc8		
	07af4c6bc8		
	07af4c6bc8		

#### AOSS Client Information

Client Information	MAC Address	Encryption Type	Wireless	Connection Setting
WLP-UC-AG300	00:1D:73:3B:26:2C	WEP64/WEP128/WPA-PSK-TKIP/WPA-PSK-AES	802.11n/g/b	Allow

### AOSS (AirStation One-Touch Secure System)

AOSS is Buffalo's unique technology for quickly forming a secure wireless connection. You can see AOSS's configuration and status from this screen.

**[Start AOSS] button**

Click this button to start AOSS. The AOSS button on top of the router works the same as this button. Refer to [How to use AOSS](#) for more details.

**[Disable AOSS] button**

This button appears when AOSS is enabled. Click this button to disable AOSS. Connections to wireless clients will be terminated, [AOSS Information](#) removed, and Encryption Type reset to its default value, AES. Current Encryption Information will also be removed. Wireless Setting and Wireless Security are enabled in Advanced Settings when AOSS is disabled.

**How to use AOSS**

How to use AOSS:

**(1)First**  
Power on or reboot the AirStation and a wireless client that supports AOSS.

**(2)Press AOSS buttons**  
After rebooting, press both products' AOSS buttons, the router's first, then the client's. The AirStation and the wireless client will exchange security information to set up the most secure encryption type automatically and are ready to communicate.

**Note:**

- Once the AOSS button is pressed, other operations can't be started until AOSS is finished. If the AirStation can't find a wireless client after three minutes, the AirStation's status returns to its previous state.
- Up to 24 wireless clients may be connected through AOSS.
- By default, AOSS is functional but does not initiate a connection unless started manually by pushing the AOSS button, either here or on the top of the router.
- Use AirStation's System Information page to manually configure a wireless client that doesn't support AOSS.
- When wireless security is configured, it's security information is succeeded.



In the following cases, the setting of wireless security is not succeeded and AOSS returns error.

- Any blank is contained in SSID.
- WPA-PSK is input with 'hexadecimal 64 characters'.
- Any blank is contained in WPA-PSK.

(C)2000-2010 BUFFALO INC. All rights reserved.

WBMR-HP-GNV2 User Manual

33

Parameter	Meaning
	Initiates AOSS automatic wireless configuration. Click this, then press or click the AOSS button on your AOSS-compatible wireless client. Repeat for additional AOSS clients.
	Click this button to disconnect AOSS connections. Note: If AOSS connections are disconnected, the SSID and encryption keys will be restored to their most recent settings before using AOSS.
Encryption Type of Exclusive SSID for WEP	You may allow a separate SSID specifically for WEP connections. If [disabled] is selected, then clients will not be able to connect with WEP.
Advanced Encryption Level feature	Expands security method from TKIP to WPA/WPA2-PSK-mixed mode.
Exclusive SSID for WEP	Set a separate SSID and network segment specifically for WEP connections. Devices connected with WEP will not be able to communicate with devices connected using AES/TKIP. All connected devices will be able to communicate with the internet.
AOSS Button on the AirStation Unit	Uncheck to disable the physical AOSS button on the AirStation.
Current Encryption Information * AOSS Connection only	Displays the encryption type, SSID, an encryption key configured by AOSS.
AOSS Client Information* * AOSS Connection only	Displays AOSS clients connected to the AirStation and information of the devices which are wirelessly communicated.

# Basic

The screen to configure a basic wireless settings.

Setup	Internet/LAN	Wireless Config	Security	LAN Config	Admin Config	Diagnostic
WPS	AOSS	Basic(11n/g/b)	Advanced(11n/g/b)	WMM(11n/g/b)	MAC Filter	Logout

Wireless Radio	<input checked="" type="checkbox"/> Enable
Wireless Channel	Auto Channel (Current Channel: 3)
150Mbps Mode	Band Width : 20 MHz
	Extension Channel : Channel 7
Broadcast SSID	<input checked="" type="checkbox"/> Allow

SSID1	<input checked="" type="checkbox"/> Use
Separate feature	<input type="checkbox"/> Use
SSID	<input checked="" type="radio"/> Name SSID based on MAC address(BUFFALO-210024) <input type="radio"/> Enter : BUFFALO-210024
Wireless authentication	No authentication
Wireless encryption	No encryption

SSID2	<input checked="" type="checkbox"/> Use
Separate feature	<input type="checkbox"/> Use
SSID	<input checked="" type="radio"/> Name SSID based on MAC address(BUFFALO-210024-1) <input type="radio"/> Enter : BUFFALO-210024-1
Wireless authentication	WPA/WPA2 mixedmode - PSK
Wireless encryption	TKIP/AES mixedmode
WPA-PSK (Pre-Shared Key)	●●●●●●●●

SSID3: AES	<input type="checkbox"/> Use
Separate feature	<input type="checkbox"/> Use
SSID	<input checked="" type="radio"/> Name SSID based on MAC address(BUFFALO-210024-2) <input type="radio"/> Enter :
WPA-PSK (Pre-Shared Key)	

SSID4: WEP	<input type="checkbox"/> Use
Separate feature	<input type="checkbox"/> Use
SSID	<input checked="" type="radio"/> Name SSID based on MAC address(BUFFALO-210024-3) <input type="radio"/> Enter :
Setup WEP encryption key	Character Input : 5 characters(WEP64)
	<input checked="" type="radio"/> 1:
	<input type="radio"/> 2:
	<input type="radio"/> 3:
	<input type="radio"/> 4:

Rekey interval	60 minutes
----------------	------------

**Basic Wireless Setting (11n/g/b)**

You can set basic configuration information for your wireless LAN manually here. If encryption is not used, communication will be established just by this basic setup. Encryption is highly recommended, however.

**Wireless Radio**  
 Unchecking "Enable" will disable wireless LAN functionality. When disabled, all wireless functionality, including broadcasting, is halted. Default value is enabled.

**Wireless Channel**  
 You may specify a channel (frequency band) for your wireless communication. If there are other wireless clients near the AirStation, you may get interference. Change to a different (and preferably non-overlapping) channel in this case. Available channels vary with which wireless standard you're using. When Auto channel is selected, a vacant channel is selected automatically. 11g : Auto, 1-11 Channel (Default value : Auto channel)

**150Mbps Mode**  
 Wireless communication commonly uses 20MHz per channel. 150Mbps Mode is a method to increase wireless transmission throughput to 40MHz per channel. When 150Mbps Mode is used, the channel display on the wireless client is likely going to differ from the channel display on the AP. The wireless client channel display may not display the Control Channel but the center frequency. In this case, the channel between the Wireless Channel and the Extension Channel is displayed.  
 Example : When channel 3 is selected as Wireless Channel, and channel 7 is selected as the Extension Channel, channel 5 is displayed.

**Band Width**  
 You can select whether 20MHz or 40MHz (150Mbps Mode) are used for wireless communication. Default value is 20MHz

**Extension Channel**  
 When 40MHz has been selected under Band Width, two channels are used. A Control Channel and an Extension Channel. The Control Channel is specified by the [ Wireless Channel ] setting, and the Extension Channel is specified by the [ Extension Channel ] setting.

Parameter	Meaning
Wireless Radio	Determines whether to allow wireless communication. If this is unchecked, then no wireless connections will be allowed.
Wireless Channel	Sets a channel (a range of frequencies) used for wireless connections. With Auto Channel selected, the AirStation will automatically use the best available channel.
150 Mbps Mode	150 Mbps mode is a method to increase wireless transmission throughput to 40 MHz per channel. To use 150 Mbps mode, set the Bandwidth to 40 MHz and choose an Extension Channel. Note: If using Auto Channel for the wireless channel, then the Extension Channel is set automatically.
Broadcast SSID	If [Allow] is checked, then the AirStation will respond to SSID searches from wireless devices by broadcasting its SSID. If [Allow] is unchecked, then the AirStation ignores SSID searches from wireless devices.
[Use Multi Security function] [Do not use Multi Security function]	Clicking [Use Multi Security function] will enable Multi Security, allowing the use of multiple SSIDs, each with different wireless security settings. Clicking [Do not use Multi Security function] will disable the Multi Security function. The AirStation will then allow one SSID and one type of wireless security.
SSID1	Always enabled and supports all wireless encryption types. Encryption can be disabled.
SSID2	Always enabled and supports all wireless encryption types. Encryption can be disabled.
SSID3	SSID3 can use WPA-PSK-AES encryption.
SSID4	SSID4 can use WEP encryption.
Separate feature	When [use] is enabled, wireless devices connected to the AirStation can communicate only with the Internet side, not with each other.
SSID	Set SSID using 1-32 alphanumeric characters.
Wireless authentication	Specifies an authentication method used when connecting to a wireless device.

---

Parameter	Meaning
Wireless encryption	<p data-bbox="641 321 1292 352">You may use any of the following types of encryption:</p> <p data-bbox="641 384 829 415"><b>No encryption</b></p> <p data-bbox="662 422 1425 485">Data is transmitted without encryption. Avoid this option since any communication may be intercepted.</p> <p data-bbox="662 491 1455 554">[No encryption] can be selected only when [No authentication] is selected for Wireless authentication.</p> <p data-bbox="641 590 699 621"><b>WEP</b></p> <p data-bbox="662 627 1425 732">WEP is a common encryption method supported by most devices. Use an encryption key to communicate with a wireless device.</p> <p data-bbox="662 739 1425 802">WEP can only be selected when [No authentication] is selected for Wireless authentication.</p> <p data-bbox="641 837 699 869"><b>TKIP</b></p> <p data-bbox="662 875 1455 980">TKIP is an encryption method which is more secure than WEP, but slower. Use a pre-shared-key to communicate with a wireless device.</p> <p data-bbox="662 987 1455 1050">TKIP can be selected only when WPA-PSK or WPA2-PSK is selected for Wireless authentication.</p> <p data-bbox="641 1085 693 1117"><b>AES</b></p> <p data-bbox="662 1123 1455 1186">AES is more secure than TKIP, and faster. Use a pre-shared-key to communicate with a wireless device.</p> <p data-bbox="662 1192 1455 1255">AES can be selected only when WPA-PSK or WPA2-PSK is selected for Wireless authentication.</p> <p data-bbox="641 1291 927 1323"><b>TKIP/AES mixed mode</b></p> <p data-bbox="662 1329 1425 1392">TKIP/AES mixed mode allows both TKIP and AES authentication and communication.</p> <p data-bbox="662 1398 1403 1461">TKIP/AES mixed mode can be selected only when WPA/WPA2 mixed mode - PSK is selected for Wireless authentication.</p>

---

<b>Parameter</b>	<b>Meaning</b>
WPA-PSK (Pre-Shared Key)	A pre-shared key or passphrase is the [password] for your wireless connections. There are two different formats for a pre-shared key. Use 8 to 63 alphanumeric characters (case-sensitive) for a [character] (ASCII) passphrase, or use 64 digits using 0 to 9 and a to f (not case-sensitive) for a [hexadecimal] passphrase..
Rekey interval	Set the update interval for the encryption key between 0 and 1440 (minutes).
Set up WEP encryption key	A WEP encryption key (passphrase) may have any of four different formats. A [character] (ASCII) passphrase may use either 5 or 13 alphanumeric characters (case-sensitive). A [hexadecimal] passphrase may use either 10 or 26 digits using 0 to 9 and a to f (not case-sensitive).

---

## Advanced

Configure advanced wireless settings.

Parameter	Meaning
BSS Basic Rate Set	Set the communication speeds of administrative and communication control frames of the AirStation and wireless devices.
Multicast Rate	Set the communication speed of multi-cast packets.
Reverse Direction Grant	For faster wireless communication, you may enable receiving packets while sending packets.
DTIM Period	Set the beacon responding interval (1 -255) for which the AirStation responds to a wireless device. This setting is effective only when power management is enabled for the wireless device.
Privacy Separator	If enabled, the Privacy Separator blocks communication between wireless devices connected to the AirStation. Wireless devices will be able to connect to the Internet but not with each other. Devices that are connected to the AirStation with wired connections will still be able to connect to wireless devices normally.
Output Power	You may reduce the wireless radio power output. The power of a radio wave and the distance that that radio wave reaches are almost proportional, so if the output power is reduced, the distance that the signal reaches also becomes smaller.



# WMM

Set priorities for specific communications.

Setup	Internet/LAN	Wireless Config	Security	LAN Config	Admin Config	Diagnostic
WPS	AOSS	Basic(11n/g/b)	Advanced(11n/g/b)	WMM(11n/g/b)	MAC Filter	Logout

### WMM-EDCA Parameters

Priority	Parameter	For AP	For STA
AC_BK(Low)	CWmin:	15	15
	CWmax:	1023	1023
	AIFSN:	7	7
	TXOP Limit:	0	0
AC_BE(Normal)	CWmin:	15	15
	CWmax:	63	1023
	AIFSN:	3	3
	TXOP Limit:	0	0
AC_VI(High)	CWmin:	7	7
	CWmax:	15	15
	AIFSN:	1	2
	TXOP Limit:	94	94
AC_VO(Highest)	CWmin:	3	3
	CWmax:	7	7
	AIFSN:	1	2
	TXOP Limit:	47	47

### WMM Settings (11n/g/b)

Prioritized AirStation communication for specific transactions. This settings provides some real time communication, which can help improve the quality of VOIP or other streaming protocols.

---

### WMM-EDCA Parameters

It is usually not necessary to change this value.

**Priority**  
The priority is ranked (Highest)8 : (High)4 : (Normal)2 : (Low)1 for each packet.

**Parameter**

**CWmin, CWmax**  
The maximum and minimum value for the contention window. The contention window is used to control the frame collision avoidance system in IEEE802.11. Values that can be inputted: 1-32767.

**AIFSN**  
Interval of the sending frame. The unit defines a time-slot (similar to the window value of CWmin, CWmax). Lower values define a higher priority as the back-off algorithm starts earlier. Values that can be inputted: 1-15.

**TXOP Limit**

(C)2000-2010 BUFFALO INC. All rights reserved.

Parameter	Meaning
WMM-EDCA Parameters	<p data-bbox="641 321 1442 394">You don't usually need to change these settings. Using the default settings is recommended.</p> <p data-bbox="641 422 740 453"><b>Priority</b></p> <p data-bbox="662 457 1446 600">The following priorities may be applied to individual transmission packets: (Highest) 8, (High) 4, (Normal) 2, and (Low) 1. From the queue, these packets are processed in order of priority.</p> <p data-bbox="641 627 846 659"><b>CWmin, CWmax</b></p> <p data-bbox="662 663 1446 846">The maximum and minimum value of the contention window. The contention window is used in the frame collision avoidance structure performed in IEEE802.11, and generally, the smaller the value in the window, the higher the probability that the queue obtains the right to send.</p> <p data-bbox="641 873 721 905"><b>AIFSN</b></p> <p data-bbox="662 909 1446 1052">The interval to send frames. The unit of the AIFSN is a slot, just as the window defined by CWmin and CWmax is. The smaller the interval of sending frames, the faster the algorithm can restart. As a result, the priority of the queue is higher.</p> <p data-bbox="641 1079 786 1110"><b>TXOP Limit</b></p> <p data-bbox="662 1115 1446 1297">The period of time that the queue can use after obtaining the right to send. The unit is 32 ms. The longer this time, the more frames can be sent per right to send. However, the queue may interfere with other packet transmissions. If TXOP Limit is set to 0 (zero), only one frame can be sent per right to send.</p>

---

## MAC Filter

Restrict access to specific wireless devices.



Parameter	Meaning
Enforce MAC Filtering	Enable to restrict wireless connections to devices with registered MAC addresses.
Registration List	Displays the MAC addresses of registered devices which are permitted to connect wirelessly.
[Edit Registration List]	Click to add a wireless device to the list of permitted devices.
MAC Addresses to be Registered	Enter a MAC address of a wireless device to permit to connect to the AirStation. Click [Register] to add that MAC address to the list.
List of all clients that are associated with this AirStation	Display the list of all MAC addresses of wireless devices connected to the AirStation.

## Security (Router Mode only)

### Firewall (Router Mode only)

Configure the AirStation's firewall.

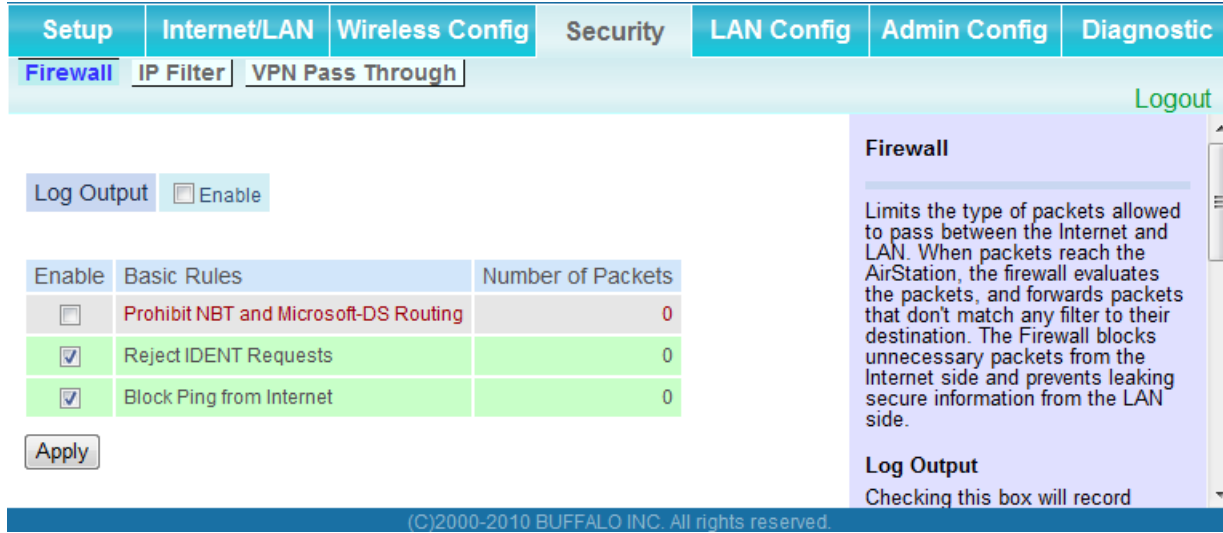

Setup Internet/LAN Wireless Config **Security** LAN Config Admin Config Diagnostic

Firewall IP Filter VPN Pass Through Logout

Log Output  Enable

Enable	Basic Rules	Number of Packets
<input type="checkbox"/>	Prohibit NBT and Microsoft-DS Routing	0
<input checked="" type="checkbox"/>	Reject IDENT Requests	0
<input checked="" type="checkbox"/>	Block Ping from Internet	0

Apply

**Firewall**

Limits the type of packets allowed to pass between the Internet and LAN. When packets reach the AirStation, the firewall evaluates the packets, and forwards packets that don't match any filter to their destination. The Firewall blocks unnecessary packets from the Internet side and prevents leaking secure information from the LAN side.

**Log Output**

Checking this box will record

(C)2000-2010 BUFFALO INC. All rights reserved.

Parameter	Meaning
Log Output	Enable to output a log of firewall activity.
Basic Rules	<p>Enable to use any of the quick filters. Preconfigured quick filters include:</p> <p><b>Prohibit NBT and Microsoft-DS Routing</b></p> <p>When this is enabled, you cannot use the Microsoft network feature from the Internet side to the LAN side and from the LAN side to the Internet.</p> <p><b>Reject IDENT Requests</b></p> <p>Enabling this option will answer IDENT requests from the Internet side with corresponding rejection packets. Enable this option if you experienced slower transfer speed for network application such as sending mail, using ftp or displaying on browser. If you have configured transfer of IDENT requests to the LAN side computer in the address translation settings (DMZ or TCP port:113), then that setting has higher priority, and overrides this setting.</p> <p><b>Block Ping from Internet</b></p> <p>If this is enabled, the AirStation will not respond to pings from the Internet side.</p>

## IP Filter (Router Mode only)

Edit IP filters.

Parameter	Meaning
Log Output	If enabled, IP filter activity is saved to a log.
Operation	Specify how to process target packets.
Direction	Specify the transmission direction of target packets.
IP Address	Specify the sender's IP address and receiver's IP address of the target packets.
Protocol	Select a protocol for target transmission packet.
IP Filter Information	Display the list of IP filters which have been registered.

## VPN Pass Through (Router Mode only)

Configure IPv6 pass through, PPPoE pass through, and PPTP pass through.



Parameter	Meaning
PPPoE Pass Through	Enable to use PPPoE bridge. Using PPPoE bridge lets you automatically obtain an IP address from your provider using the PPPoE protocol from your computer connected to the LAN side because all PPPoE packets can pass through between the Internet and LAN.
PPPTP Pass Through	Enable to use the PPTP Pass Through for address translation.

# LAN Config

## Port Forwarding (Router Mode only)

Configure port translation.

**Port Forwarding Settings**

Although the AirStation performs Address Translation only for communication which is started from the LAN side, certain applications, such as network games, require that you allow communications from the Internet (the Internet) side via (Static NAT). Edit the rules for communicating from outside the internal network to the LAN side network device (Static NAT) carefully, consulting your internet game's documentation as necessary. Up to 32 rules can be registered.

**Add/Edit Port Forwarding**

You can add new port forwarding information and edit existing information.

**Group**

You can give a name (group name) to configured Static NATs and give multiple Static NATs one name and manage them together. By giving names to groups, you can [Enable] or [Disable] each

Group	Internet Side IP Address LAN Side IP Address	Protocol LAN Side Port	Customize
Port Forwarding has not been set up yet			

(C)2000-2010 BUFFALO INC. All rights reserved.

**Parameter**

**Meaning**

Group	Specify a group name for a new rule to belong to. Select [New Group] and enter the new group name in the Group Name field to create a new group. A group name can include up to 16 alphanumeric letters.
Protocol	Select the Internet side protocol (before translation) for the port translation table entry.

---

<b>Parameter</b>	<b>Meaning</b>
LAN Side IP Address	Enter the LAN side IP address (after translation) for the port translation table entry.
LAN Side Port	Select the LAN side (after translation) port number (1 - 65535) for the port translation table entry.
Port Forwarding Registration Information	Shows current entries in the port translation table.

---



## DMZ (Router Mode only)

Configure a destination to transfer communication packets without a LAN side destination to.

Parameter	Meaning
IP Address of DMZ	Enter the IP address of the destination to which packets which are not routed by a port translation table are forwarded. Note: RIP protocol packets (UDP port number 520) will not be forwarded.

## UPnP (Router Mode only)

Configure UPnP (Universal Plug and Play).

Parameter	Meaning
UPnP	Enable or disable Universal Plug and Play (UPnP) functionality.

## QoS (Router Mode only)

Configure the priority of packets sent to the Internet.

QoS for transmission to the Internet  Enable

Upload bandwidth  Kbps

No.	Enable	application name	protocol	destination port	priority
1	<input type="checkbox"/>	VoIP	UDP		high
2	<input type="checkbox"/>	ssh	TCP	22	medium
3	<input type="checkbox"/>	telnet	TCP	23	medium
4	<input type="checkbox"/>	ftp	TCP	21	low
5	<input type="checkbox"/>		TCP		high
6	<input type="checkbox"/>		TCP		high
7	<input type="checkbox"/>		TCP		high
8	<input type="checkbox"/>		TCP		high

Apply

**QoS Setting**

QoS is a technology to use the bandwidth on the network more effectively. When two or more packets arrive at the same time, the packet with higher priority is processed first. This can be used to give priority to communications that require real time processing, such as VOIP.

**QoS for transmission to the Internet**

If checked, this gives priority to packets being transmitted to the Internet. When enabled, you will be able to add four levels of increased priority for specific applications. By default, this is disabled.

**Uplink Bandwidth**

Specify the bandwidth transferred from this unit to the Internet in kbps. The real uplink bandwidth should be entered. If a bandwidth value larger than the real line speed is entered, the uplink bandwidth will be limited by the line speed. If a smaller bandwidth value is entered, the maximum line speed cannot be used. Use a link speed measuring tool on the

(C)2000-2010 BUFFALO INC. All rights reserved.

Parameter	Meaning
QoS for transmission to the Internet	Determine whether or not to prioritize packets sent to the Internet. Check this box to enable QoS.
Upload bandwidth	Specify the upstream bandwidth in kbps from the AirStation to the internet side. Set the actual value for the upstream bandwidth.
Enable	Enable or disable this entry.
application name	Enter an application name. Names may use up to 32 alpha numerical characters, double or single tick marks ("), quotation marks ("), and semicolons (;).
protocol	Select either TCP or UDP.

Parameter	Meaning
destination port	Specify a destination port with the value of 1 - 65535. If this field is empty, a random port is selected.
priority	Select high, medium or low. If packets do not qualify for classification as a type on the list, then their priority is treated as a level between medium and low.

---

## Admin Config

---

### Name

Configure basic AirStation's settings.

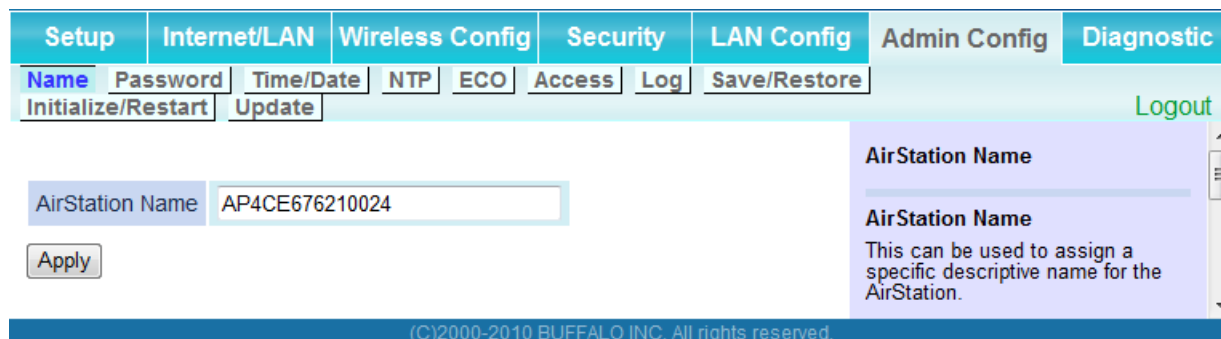

Parameter	Meaning
AirStation Name	Enter a name for the AirStation. Names may include up to 64 alphanumeric characters and hyphens (-).

---

## Password

Configure the password to log in to the AirStation's configuration screen.

The screenshot shows the configuration interface for the AirStation. At the top, there are tabs for Setup, Internet/LAN, Wireless Config, Security, LAN Config, Admin Config, and Diagnostic. Under the Security tab, there are sub-tabs for Name, Password, Time/Date, NTP, ECO, Access, Log, and Save/Restore. The Password sub-tab is active. The Administrator Name is set to 'root (fixed)'. The Administrator Password field is empty, and there is a confirmation field below it. An 'Apply' button is located below the password fields. On the right side, there is a help box titled 'AirStation Administrator Password' which states: 'Administrator name: This is the user name used to log into the AirStation's configuration screens. It cannot be changed from 'root'. Administrator password:'. At the bottom of the interface, there is a copyright notice: '(C)2000-2010 BUFFALO INC. All rights reserved.'

Parameter	Meaning
Administrator Name	The Administrator name is used to log in to the AirStation's configuration utility. This name is fixed as [root].
Administrator Password	The password is required to log in. It may contain up to 8 alphanumeric characters and underscores (_).

## Time/Date

Configure the AirStation's internal clock.

Setup	Internet/LAN	Wireless Config	Security	LAN Config	Admin Config	Diagnostic
<a href="#">Name</a>	<a href="#">Password</a>	<a href="#">Time/Date</a>	<a href="#">NTP</a>	<a href="#">ECO</a>	<a href="#">Access</a>	<a href="#">Log</a>
<a href="#">Initialize/Restart</a>	<a href="#">Update</a>			<a href="#">Save/Restore</a>		<a href="#">Logout</a>

Local Date	2010	Year	12	Month	30	Day
Local Time	12	Hour	34	Minute	56	Seconds
Time Zone	(GMT+00:00)Greenwich Mean Time, London					

**Time/Date**

Set the AirStation's internal clock. Set the internal clock manually.

**Note:**  
The AirStation's internal clock is reset to its default setting whenever power is lost because it doesn't have a battery. However, the AirStation may be configured to adjust its clock.

(C)2000-2010 BUFFALO INC. All rights reserved.

Parameter	Meaning
Local Date	You may manually set the date of the AirStation's internal clock.
Local Time	You may manually set the time of the AirStation's internal clock.
Time Zone	Specify the time zone (offset of Greenwich Mean Time) of the AirStation's internal clock.

## NTP

Configure an NTP server to automatically synchronise the AirStation’s internal clock.



Parameter	Meaning
NTP Functionality	Enable to use an NTP server. The default is disabled.
NTP Server	Enter the name of the NTP server as a host name, host name with domain name, or IP address. Up to 255 alphanumeric characters, hyphens (-), and underscores (_) may be used. The default is [time.nist.gov].
Update Interval	How often will the AirStation check the NTP server for the correct time? Intervals of 1 - 24 hours may be set. The default is 24 hours.

# ECO

Configure Eco mode from this screen.

Setup
Internet/LAN
Wireless Config
Security
LAN Config
Admin Config
Diagnostic

Name
Password
Time/Date
NTP
ECO
Access
Log
Save/Restore

Initialize/Restart
Update
Logout

Schedule feature  Enable

---

**Weekly schedule**

	00	02	04	06	08	10	12	14	16	18	20	22
Sun												
Mon												
Tue												
Wed												
Thu												
Fri												
Sat												

Normal  
  Sleep  
  User Define

Operational Mode: Normal

Start time: 0:00

End time: 0:30

The day of week: Sun  Mon  Tue  Wed  Thu  Fri  Sat

---

**User Define Mode Settings**

User Define Mode	LED	<span>Off</span>
	Wired LAN	<span>ECO (Slow operation)</span>
	Wireless LAN	<span>Off</span>

(C)2000-2010 BUFFALO INC. All rights reserved.

**ECO**

Configure ECO Mode. Enabling ECO Mode will put it in energy save operation according to Weekly schedule.

**Schedule feature**

Selecting "Enable" will enable ECO Mode and change the operation mode according to Weekly schedule. The default is disabled.

**Note:**

- The Operational Mode is changed even during communicating at the time set in the weekly schedule. Please note that communication may be disconnected in such a case.
- AOSS does not work during ECO mode if the Operational Mode is not "normal".
- Pressing and holding AOSS button on the main unit while the Operational Mode is not Normal can temporarily recover it to "Normal".

**Weekly schedule**

Register Weekly schedule. If you want to change the Operational Mode you have registered, overwrite a period of time you want to change in the new Operational Mode.

**Register schedule**

**Operational Mode**

Select the Operational Mode. The default value is "Normal".

**Normal**

Does not perform energy saving operation.

**Sleep**

Perform following the energy saving operation.

- \* Turn off LED
- \* Stop wired LAN
- \* Stop wireless LAN

---

Parameter	Meaning
Schedule feature	Enable to schedule Eco mode. <b>Note:</b> If Schedule is enabled, AOSS will only function while the AirStation is in Normal Operating Mode.
Weekly schedule	Graphically displays the configured schedule.
Register schedule	Configure operational mode for time periods in the weekly schedule. If User Defined mode is chosen, configure it below.
User Define Mode	Individual power saving elements may be configured individually for User Defined mode.

---



## Access

Restrict access to the AirStation’s settings screens.

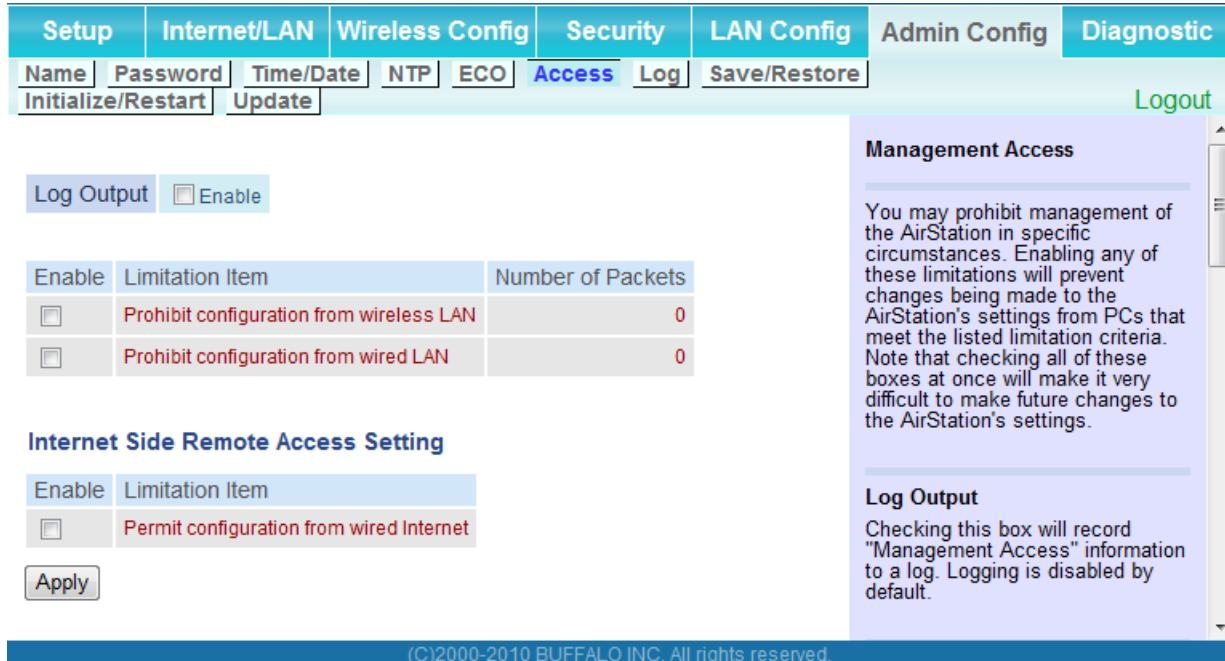

Parameter	Meaning
Log Output	Enabling outputs a log of changes to access settings.
Prohibit configuration from wireless LAN	If enabled, prevents access to settings screens from wirelessly connected devices (only wired devices may configure).
Prohibit configuration from wired LAN	If enabled, prevents access to settings screens from wired devices (only wirelessly connected devices may configure).
Permit configuration from wired Internet	If enabled, allows access to settings screens from network devices on the WAN (Internet) side.
Permitted IP address	Displayed only if Internet side configuration is enabled. Enter the IP address of a device that is permitted to configure the AirStation remotely from the WAN (Internet) side.
Permitted Port	Displayed only if Internet side configuration is enabled. Set a port number (1 - 65535) to configure the AirStation from the WAN (Internet) side.

# Log

Transfer the AirStation's logs to a syslog server.

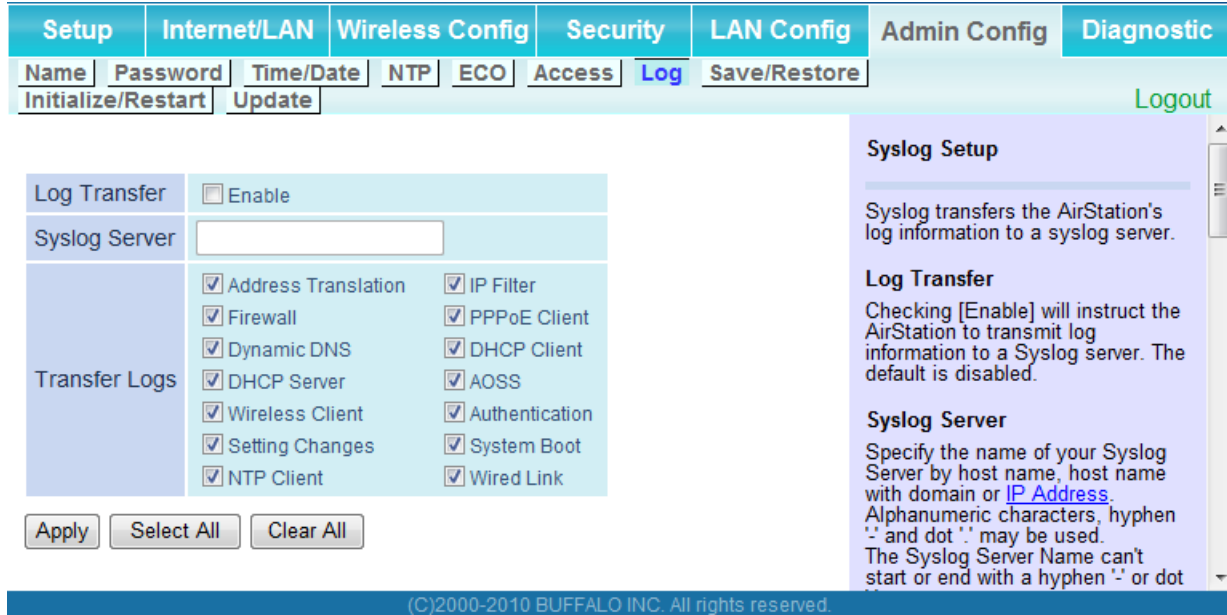

Parameter	Meaning
Log Transfer	Enable to send logs to a syslog server.
Syslog Server	Identify the syslog server by host name, host name with domain name, or IP address. You may enter up to 255 alphanumeric characters, hyphens (-), and underscores (_).
Transfer Logs	Choose which logs will be transferred to the syslog server.

## Save/Restore

Save AirStation settings as a file, and restore from them later.



Parameter	Meaning
Save current settings	Clicking [Save] will save the current configuration of the AirStation to a file. If the [Encrypt the configuration file with a password] option is checked, then the configuration file will be password protected with the current Administrator Password.
Restore Configuration from Backup File	Restore the configuration of the AirStation from a saved configuration file by clicking the [Browse...] button, navigating to the configuration file, and then clicking Restore. If the configuration file was password protected, then put a check next to [To restore from the file you need the password], enter the password, and click [Open].

## Initialize/Restart

Initialize or restart the AirStation.

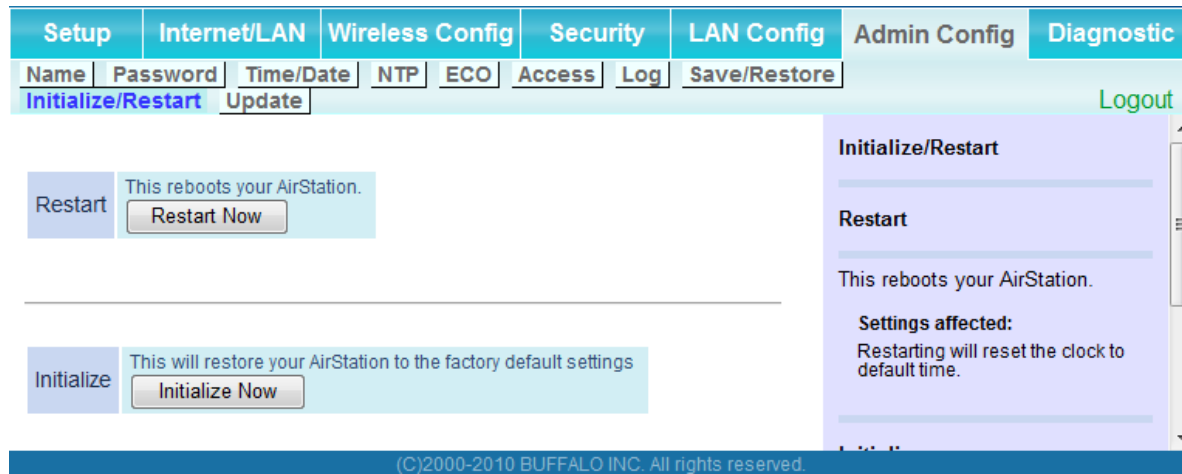

Parameter	Meaning
Restart	Click [Restart Now] to restart the AirStation.
Initialize	Click [Initialize Now] to initialize and restart the AirStation.

## Update

Update the AirStation's firmware.

Parameter	Meaning
Firmware Version	Displays the current firmware version of the AirStation.
Update Method	<p><b>Specify Local File</b> Updates from a firmware file stored on your computer.</p> <p><b>Automatic Update (On Line Version Up)</b> Automatically updates to the latest firmware available.</p>
Firmware File Name	Click [Browse...] to navigate to the firmware file on your computer if [Specify Local File] was selected. You don't need to specify the firmware location if you're using [Automatic Update]. Click [Update Firmware] to update the firmware.

# Diagnostic

## System Info

View system information for the AirStation.

Setup	Internet/LAN	Wireless Config	Security	LAN Config	Admin Config	Diagnostic
<a href="#">System Info</a>	<a href="#">Logs</a>	<a href="#">Packet Info</a>	<a href="#">Client Monitor</a>	<a href="#">Ping</a>	<a href="#">DSL Connection</a>	<a href="#">Logout</a>

<b>Model</b>	WBMR-HP-GNV2 Ver.1.00(R0.24/B1.01)	
<b>AirStation Name</b>	AP4CE676210024	
<b>Operational Mode</b>	Router Mode ON	
<b>Internet</b>	Method of Acquiring IP Address	RFC 1483 Bridged + Obtain IP Automatically
	Connection Status	stopped/not communicating (no lease)
	Wired Link	Down
<b>LAN</b>	IP Address	192.168.11.1
	Subnet Mask	255.255.255.0
	DHCP Server	Enabled
	MAC Address	4C:E6:76:21:00:24
<b>Wireless(802.11n/g/b)</b>	Wireless Status	Enabled
	SSID1	BUFFALO-210024
	Authentication	Open
	Encryption	Open
	SSID2	BUFFALO-210024-1
	Authentication	WPA/WPA2 mixedmode - PSK
	Encryption	TKIP/AES mixedmode
	Broadcast SSID	Enable
	Privacy Separator	Disable
	Wireless Channel	3(Auto)
150Mbps Mode	20 MHz	
MAC Address	4C:E6:76:21:00:24	
<b>ECO Mode</b>	Status	Disable Schedule feature

**System Information**

Display the AirStation's main settings.

**Model**  
Displays the model name and firmware version of the AirStation.

**AirStation Name**  
Displays the AirStation's host name.

**Operational Mode**  
Displays the current mode of operation.

**Internet**  
AirStation's [Internet port](#) side information.

**Method of Acquiring IP Address**  
Acquiring a Internet IP address.

**Name of Connection**  
The name of the PPPoE connection specified in the configuration.

**Connection Status**  
Displays the current Internet side status.

**Operational Mode**  
The Operational Mode will show if any DHCP or PPPoE configuration is active. If DHCP is in use, the following commands can be executed.

- [Release] : Releases the IP address assigned by the DHCP Server.
- [Renew] : Renews the IP address from the DHCP Server.

The following commands can be executed when using PPPoE.

- [Start] : Start connecting to a

(C)2000-2010 BUFFALO INC. All rights reserved.

---

<b>Parameter</b>	<b>Meaning</b>
Model	Displays the product name of the AirStation and the firmware version.
AirStation Name	Displays the AirStation Name.
Operational Mode	Displays the current operational mode of the AirStation.
Internet	Displays the information about the Internet port.
LAN	Displays the information about the LAN port.
Wireless	Displays the wireless status.
ECO Mode	This indicates the operating status of ECO Mode.

---

## Logs

The AirStation's logs are recorded here.

**Display log info**

<input checked="" type="checkbox"/> Address Translation	<input checked="" type="checkbox"/> IP Filter
<input checked="" type="checkbox"/> Firewall	<input checked="" type="checkbox"/> PPPoE Client
<input checked="" type="checkbox"/> Dynamic DNS	<input checked="" type="checkbox"/> DHCP Client
<input checked="" type="checkbox"/> DHCP Server	<input checked="" type="checkbox"/> AOSS
<input checked="" type="checkbox"/> Wireless Client	<input checked="" type="checkbox"/> Authentication
<input checked="" type="checkbox"/> Setting Changes	<input checked="" type="checkbox"/> System Boot
<input checked="" type="checkbox"/> NTP Client	<input checked="" type="checkbox"/> Wired Link

Display    Select All    Clear All

**Logs**

Save to file logfile.log.    Delete

Date Time	Type	Log Content
2010/12/30 12:35:20	AUTH	Admin login from source 192.168.11.64
2010/12/30 12:35:04	DHCPS	IP: 192.168.11.64 to MAC address 00:11:09:94:f5:b9
2010/12/30 12:35:04	DHCPS	received REQUEST
2010/12/30 12:35:04	DHCPS	sending OFFER of 192.168.11.64
2010/12/30 12:35:04	DHCPS	received DISCOVER
2010/12/30 12:35:04	DHCPS	received REQUEST
2010/12/30 12:35:03	SYSTEM	Firmware Ver.1.00(R0.24/B1.01)
2010/12/30 12:35:03	SYSTEM	WBMR-HP-GNV2 boot up successfully
2010/12/30 12:35:03	WIRED	LAN port 1 link up
2010/12/30 12:34:57	DHCPS	DHCP server started

(C)2000-2010 BUFFALO INC. All rights reserved.

**Logs**

Display log information recorded in the AirStation. The oldest information is overwritten by new logs.

**Display log info**

Select the types of information that should be logged by the AirStation. The default is All. The following items can be selected:

- Address Translation
- IP Filter
- Firewall(Includes discarded IP Masquerade packets)
- PPPoE Client(Internet side)
- Dynamic DNS(Internet side)
- DHCP Client(Internet side)
- DHCP Server(LAN side)
- AOSS
- Wireless Client(Start/stop and client connection)
- Authentication
- Setting Changes
- System Boot
- NTP Client
- Wired Link(Internet/LAN)

**Chart of TYPE names**

LOG INFO	TYPE
Address Translation	NAT
IP Filter	FILTER

Parameter	Meaning
Display log info	Choose the types of logs to display.
Logs	Displays the log information recorded in the AirStation.



## Packet Info

View packet transfer information.

Setup	Internet/LAN	Wireless Config	Security	LAN Config	Admin Config	Diagnostic
System Info	Logs	Packet Info	Client Monitor	Ping	DSL Connection	Logout

Interface	Sent		Received	
	Normal	Errors	Normal	Errors
Wired LAN	786	0	907	0
Wired Internet	0	0	0	0
Wireless LAN (802.11n/g/b)	86	0	127	0

**Packet Traffic Information**

The total numbers of packets sent and received by the AirStation, as well as the errors sending and receiving, are displayed.

**[Refresh] button**  
Displayed packet information is renewed with current information when this button is clicked.

(C)2000-2010 BUFFALO INC. All rights reserved.

### Parameter

### Meaning

Sent

Displays the number of packets sent to the Internet side of Ethernet, the LAN side of the Ethernet, and the LAN side of the wireless connection.

Received

Displays the number of packets received from the Internet side of Ethernet, the LAN side of the Ethernet, and the LAN side of the wireless connection.

## Client Monitor

This screen shows devices that are connected to the AirStation.

MAC Address	Lease IP Address	Hostname	Communication Method	Wireless Authentication	802.11n
00:11:09:94:F5:B9	192.168.11.64	John-PC	Wired	-	-

Refresh

(C)2000-2010 BUFFALO INC. All rights reserved.

Parameter	Meaning
Client Monitor	Displays information ( MAC address, lease IP address, host name, communication method, wireless authentication and 802.11n) for devices that are connected to the AirStation.

## Ping

A Ping test checks whether the AirStation can communicate with a specific network device.



Parameter	Meaning
Destination Address	Enter an IP address or a host name of the device for which you try to verify the connection, and click [Execute]. The result will be displayed in the [Result] field.

## DSL Connection

View DSL Connection for the AirStation.

<b>Setup</b>	<b>Internet/LAN</b>	<b>Wireless Config</b>	<b>Security</b>	<b>LAN Config</b>	<b>Admin Config</b>	<b>Diagnostic</b>
System Info	Logs	Packet Info	Client Monitor	Ping	<b>DSL Connection</b>	Logout

**DSL Status**

DSL Status	Down
DSL Modulation Mode	
DSL Path Mode	
Downstream Rate	
Upstream Rate	
Downstream Margin	
Upstream Margin	
Downstream Line Attenuation	
Upstream Line Attenuation	
Downstream Transmit Power	
Upstream Transmit Power	

**PVC Connection**

Encapsulation	
Multiplexing	
QoS	
PCR Rate	
SCR Rate	
Autodetect	
VPI	
VCI	
Enable	
PVC Status	

**DSL Connection**

**DSL Status**  
If a DSL link has been established, technical information about it is shown here.

**PVC Connection**  
This section reflects settings in the Internet Connection Type and VC settings sections of the Internet/LAN setup panel. See that panel's Help page for detailed descriptions.

Also shown here is PVC Status. This can be shown as "Down" or "Applied."

(C)2000-2010 BUFFALO INC. All rights reserved.

Parameter	Meaning
DSL Status	If a DSL link has been established, technical information about it is shown here.
PCV Connection	This section reflects settings in the Internet Connection Type and VC settings sections of the Internet/LAN setup panel. See that panel's Help page for detailed descriptions.

# Chapter 5 - Connect to a Wireless Network

## Automatic Secure Setup (AOSS/WPS)

---

AOSS and WPS are systems which enable you to automatically configure wireless LAN settings. Just pressing the buttons will connect wireless devices and complete security settings. Easily connect to any wireless devices, computers, or game machines which support AOSS or WPS.



AOSS (AirStation One-Touch Secure System) was developed by Buffalo Technology. WPS was created by the Wi-Fi Alliance.

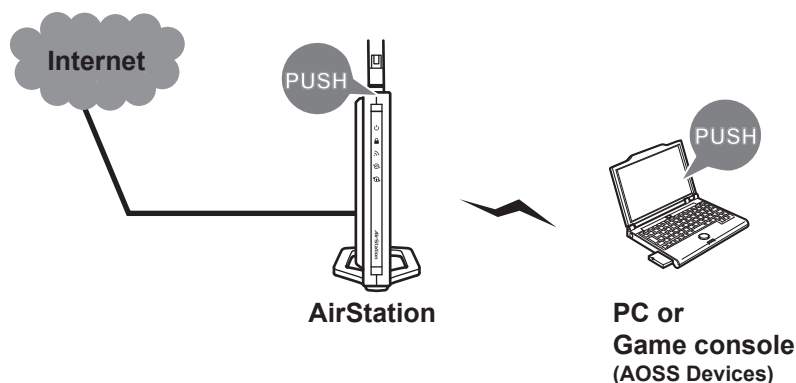

- Before using AOSS or WPS to connect to a Buffalo wireless client, install Client Manager software from the included AirNavigator CD. Consult your wireless client's documentation for more information.
- Buffalo's Client Manager software can be used with the wireless LAN devices built into your computer. However, it is not guaranteed to work with all wireless LAN devices available. Some wireless clients may require manual setup.

## Windows 7/Vista (Client Manager V)

If you are using Windows 7/Vista, use the included Client Manager V software to connect wirelessly with AOSS/WPS.

1 Click the icon  in the system tray.

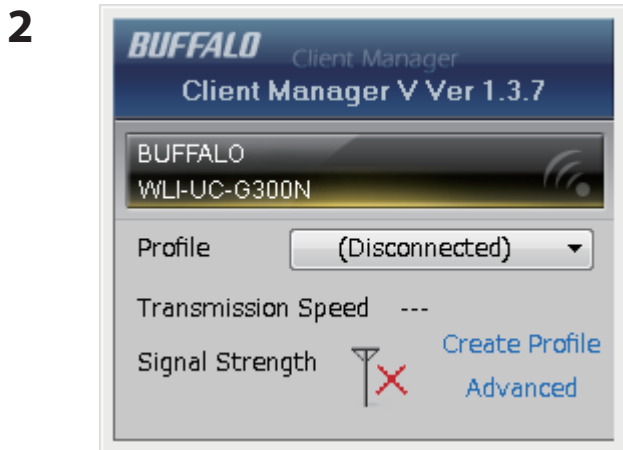

When the screen at left is displayed, click [Create Profile].

3 If the User Account Control screen opens, click [Yes] or [Continue].

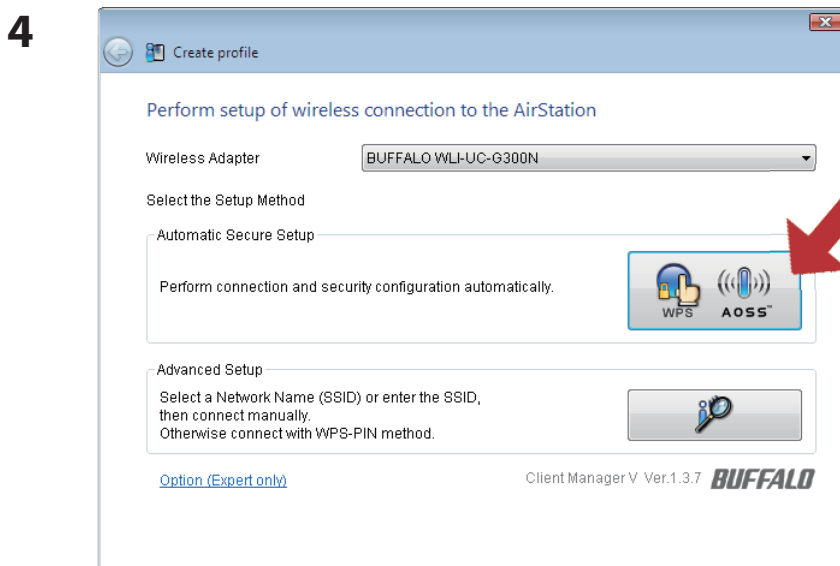

Click the [WPS AOSS] button.

Follow any instructions displayed on the screen. When the Security LED on the front of the AirStation stops flashing and is lit steadily, the connection is complete.

## Windows XP (Client Manager 3)

If you are using Windows XP, use Client Manager 3 to connect wirelessly with AOSS/WPS.

1 Right click on the  icon in the system tray, and select [Profile].

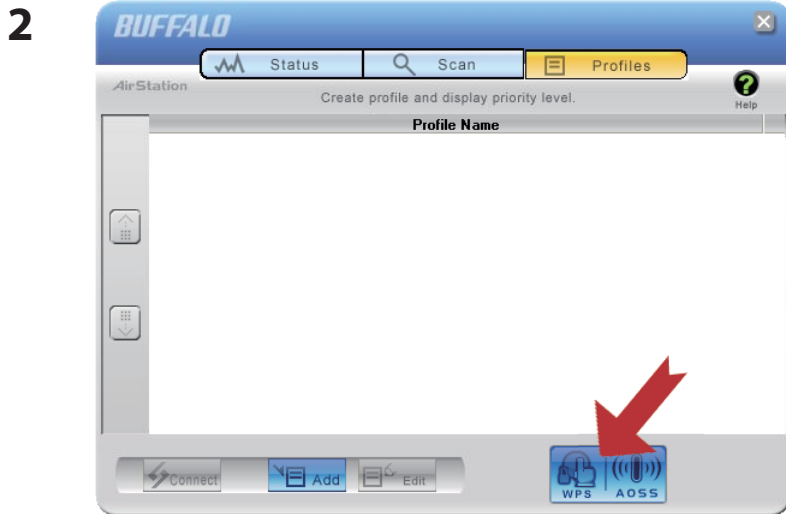

Click the [WPS AOSS] button.

Follow any instructions displayed on the screen. When the Security LED on the front of the AirStation stops flashing and is lit steadily, the connection is complete.

## Other Devices (e.g. Game Console)

If you are using a game machine which supports AOSS or WPS, refer to that device's manual to initiate AOSS/WPS. When instructed, hold down the AOSS button on the AirStation for 1 second.

When the Security LED stops blinking and is lit steadily, the connection is complete.

## Manual Setup

You can also connect to the AirStation without installing Client Manager V or Client Manager 3 by using the utility built-in to Windows. The procedure varies depending on which version of Windows you are using.

- Note:**
- If the AirNavigator CD is used to perform setup when making the initial settings of AirStation, the wireless connection settings for the AirStation are completed during the Setup process. As a result, you do not need to make the settings below. After setup is complete, once the LAN cable is removed, you can connect from your wireless client to the AirStation.
  - Before performing setup, make the settings to enable the wireless client of the computer.

### Windows 7 (WLAN AutoConfig)

With Windows 7, use WLAN AutoConfig to connect to the AirStation.

- 1 Click on the network icon  in the system tray.

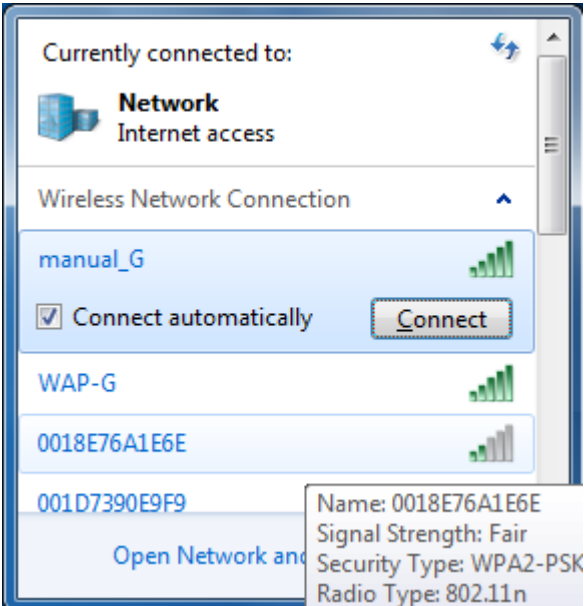
- 2  Select the target AirStation's name and click [Connect]. If you will be connecting to this device in the future, checking [Connect automatically] is recommended.



3

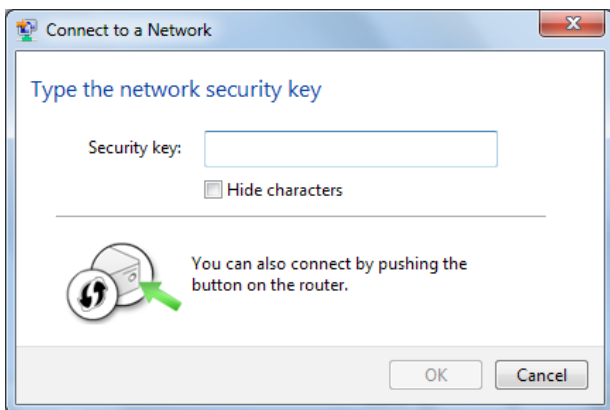

Enter the encryption key and click [OK].

## Windows Vista (WLAN AutoConfig)

With Vista, use WLAN AutoConfig to connect to the AirStation.

1

Right click on the wireless network icon  in the system tray.

2

Click [Connect to a network].

3

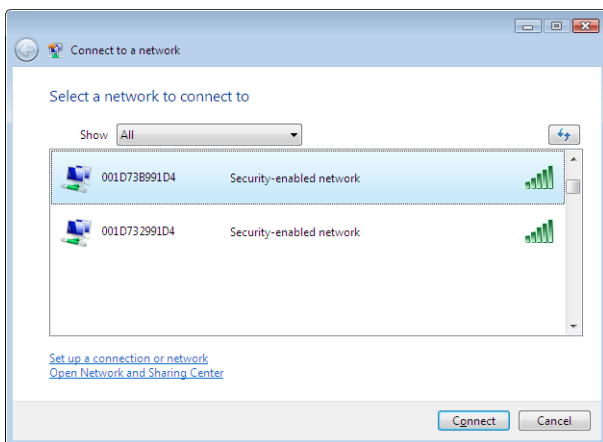

When the screen at left is displayed, select the network to connect to and click [Connect].

If the screen below is displayed, click [I want to enter the network key or passphrase instead]. Otherwise, go to step 4.

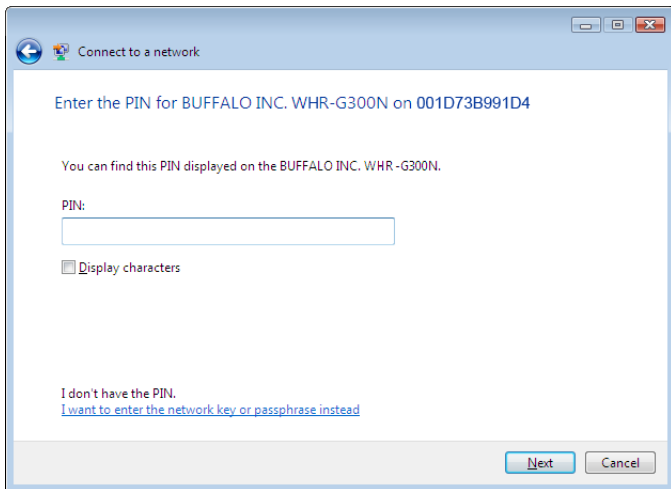
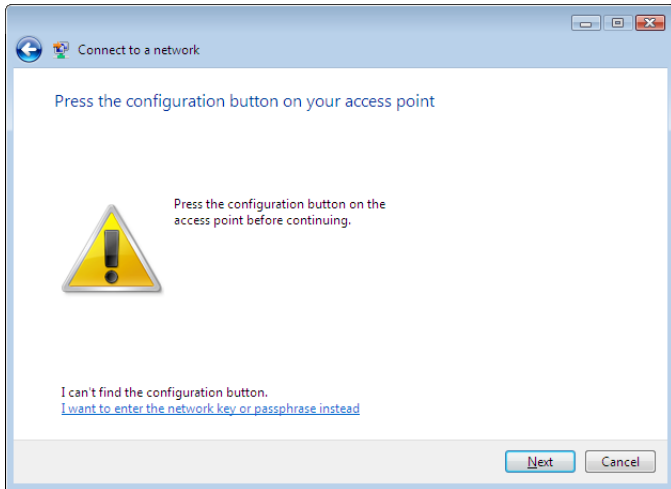

4

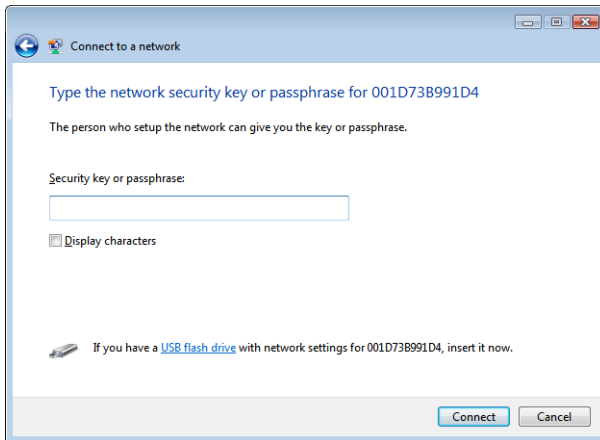

Enter the encryption key and click [Connect].

Step through the wizard to finish configuration. If the Set Network Location screen is displayed, select [Home], [Work], or [Public location] depending where you're using the AirStation.

## Windows XP (Wireless Zero Configuration)

Windows XP includes a built-in utility to connect to your AirStation.

**Note:** If Client Manager 3 is installed on your computer, Wireless Zero Configuration is disabled. Uninstall Client Manager 3 to use Wireless Zero Configuration, or just use Client Manager 3 to connect to the AirStation.

**1** Right click on the wireless network icon  displayed in the system tray.

**2** Click [View Available Wireless Networks].

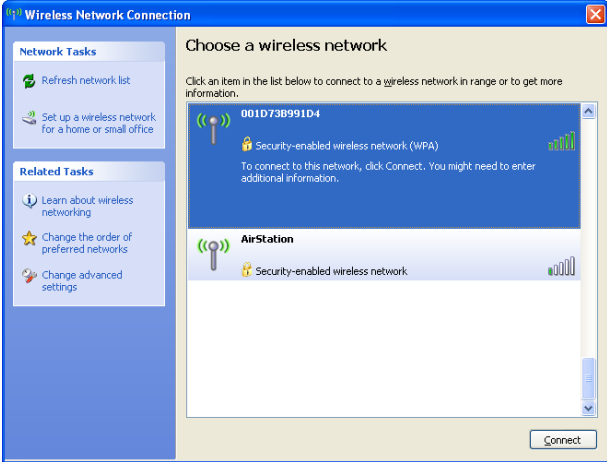
**3**  Select the network to connect to and click [Connect].

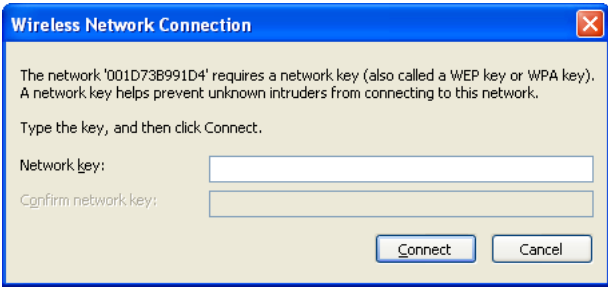
**4**  Enter the encryption key (twice) and click [Connect].

Follow the instructions displayed on the screen to finish configuration.

## Mac OS X (AirPort)

Use AirPort in the Mac OS X to connect to the AirStation.

1

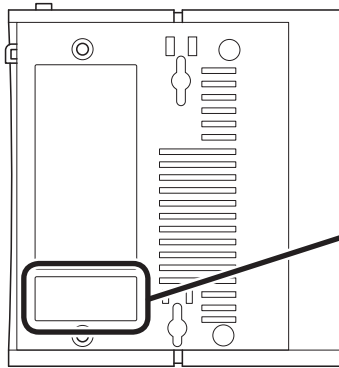

Refer to the label on the side of the AirStation, and make a note of the SSID and KEY printed on the label.

2

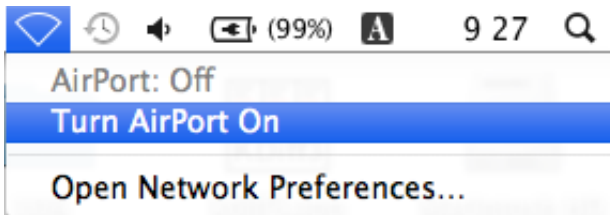

Click the  icon in the top section of the screen, and select [Turn AirPort On].

3

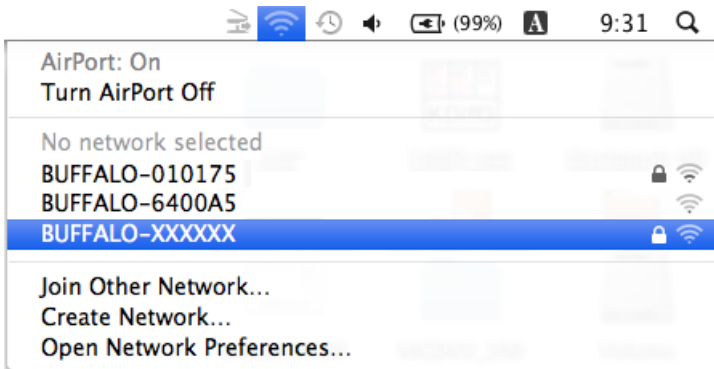

Click the value that matches the SSID that was noted in step 1.

4

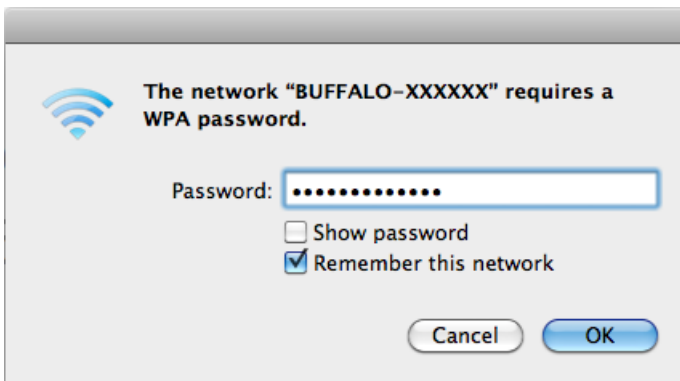

Enter the value for the KEY that was noted in step 1 into the Password entry box, insert a check mark into [Remember this network], and click [OK].

Follow the instructions displayed on the screen to finish configuration.

# Chapter 6 - Trouble Shooting

## **Cannot connect to the Internet over wired connection.**

- Make sure that your AirStation is plugged in!
- Check that the status LEDs of your AirStation are lit as below:
  - Power     Green light is ON
  - DSL        Green light is ON or OFF (depending on your environment)
  - Internet   Green light is ON or flashing
- Make sure that your computer is set to [Obtain an IP address automatically]. (see appendix C)
- Refer to the documentation provided by your provider, and make the correct ADSL settings.
- Restart your AirStation.

## **Cannot access the web-based configuration utility.**

- See chapter 4 for instructions to open the AirStation's configuration utility.
- Enter the correct user name and password to login to the configuration screen. The factory defaults are [root] (in lower case) for the user name and a blank password (enter nothing). If you changed the password, enter the new password that you set.
- Verify that your web browser is not set to use proxies.
- Make sure that your computer is configured to [Obtain an IP Address Automatically]. (see appendix C)
- Restart your AirStation.

## Cannot connect to the network wirelessly.

---

- Configure your wireless client with the same SSID, encryption type, and encryption key as set on the AirStation.

The factory defaults are:

SSID - BUFFALO-XXXXXX (the last 6 digits of the AirStation's MAC address)  
Encryption Type - WPA/WPA2 mixed mode - PSK (Connect with either WPA-PSK TKIP or WPA2-PSK AES).  
Encryption Key - Printed on the label of the AirStation.

**Note: Encryption is disabled by default in Asia Pacific.**

- Place your AirStation and wireless devices 2 - 10 feet apart.
- Restart your AirStation.

## You forgot AirStation's SSID, Encryption Key, or Password.

---

Hold down the Reset button on the base of your AirStation for 3 seconds to initialize its settings. All settings, including your password, SSID, and encryption key will be initialized to their defaults. The factory defaults are:

SSID - BUFFALO-XXXXXX (the last 6 digits of the AirStation's MAC address)  
Encryption Type - WPA/WPA2 mixed mode - PSK (Connect with either WPA-PSK TKIP or WPA2-PSK AES).  
Encryption Key - Printed on the label of the AirStation.  
(Encryption is disabled by default for Asia Pacific AirStations.)

## The link speed is slower than 150 Mbps (Maximum link speed is only 65 Mbps).

---

By default, the AirStation's 150 Mbps mode is not enabled. You may enable it with the following procedure:

1. Open the configuration utility (chapter 4).
2. Click [Wireless SSID & Channel (11n 150 Mbps Mode)] in Easy Setup.
3. Change the value in [150 Mbps Mode] - [Band Width] to 40 MHz and click [Apply].

If you still cannot connect at 150 Mbps, check the settings of your wireless client device.

## Other Tips

---

### **Issue:**

I reset my wireless router to factory settings and forgot how to log in to the configuration utility.

### **Answer:**

Open your browser and enter 192.168.11.1 as the browser address and hit Enter. You will be prompted to log in. Enter the user name as root and the password box is left empty (no password). Click [OK] to complete the login and the option to reset your password will be available on the first page.

### **Issue:**

How do I forward ports on my wireless router for my gaming console?

### **Answer:**

Log in to the router's configuration utility. From the home page, go to the Internet Game/ Port Mapping section. Enter the port that needs to be forwarded, and the IP address of the gaming console.

### **Issue:**

How do I enable or modify security encryption settings on the wireless router?

### **Answer:**

Log in to the configuration utility with your browser. Go to the Wireless Config tab and then select the Security tab. Buffalo recommends WPA for wireless encryption. The passphrase/key should be at least 8 characters in length.

### **Issue:**

How do I change my wireless router's broadcasted network name (SSID)?

### **Answer:**

Log in to the configuration utility. Go to the Wireless Config tab and then select the Basic tab if necessary. Find the settings area for SSID. Select the [Use] radio button and enter the name you wish to use for your network in the text field provided. Click [Apply] to save the settings. Once the wireless router has rebooted, you will need to manually select the new network name for all wireless devices and enter your encryption key if necessary.



**Issue:**

What can I do if my wireless connection drops randomly or seems slow?

**Answer:**

There are many environmental factors that may cause this. First, ensure the issue is not range related by moving the wireless router and the client device closer together. If the connection drops continue, then range is probably not the issue.

Other 2.4 GHz devices such as microwaves, other wireless networks, and 2.4 GHz wireless phones may impact performance. Try a different wireless channel for your wireless router. Log in to the wireless router with your browser. Click on the Wireless Config tab and then the Basic tab. Wireless channels from 1 - 11 may be selected. Try the Auto-Channel option if available. Otherwise, manually select an alternate channel and click [Apply].

**Issue:**

Where can I download the latest drivers, firmware and instructions for my Buffalo wireless products?

**Answer:**

The latest drivers and firmware are available online at **[www.buffalotech.com](http://www.buffalotech.com)**

# Appendix A - Specifications

<b>Wireless LAN Interface</b>	
Standard Compliance	IEEE802.11b / IEEE802.11g / IEEE802.11n
Transmission Method	Direct Sequence Spread Spectrum (DSSS), OFDM, SISO
Frequency Range	2,412 - 2,462 MHz (Channels 1 - 11)
Transmission Rate	802.11b/g: 54, 48, 36, 24, 18, 12, 9, 6, 11, 5.5, 2, 1 Mbps 802.11n 20 MHz BW (LongGI) 65, 58.5, 52, 39, 26, 19.5, 13, 6.5 Mbps (ShortGI) 72.2, 65.0, 57.8, 43.3, 28.9, 21.7, 14.4, 7.2 Mbps 40 MHz BW (LongGI) 135, 121.5, 108, 81, 54, 40.5, 27, 13.5 Mbps (ShortGI) 150, 135, 120, 90, 60, 45, 30, 15 Mbps
Access Mode	Infrastructure Mode
Security	AOSS, WPA2-PSK (TKIP/AES), WPA/WPA2 mixed PSK, WPA-PSK (TKIP/AES), 128/64bit WEP, Mac Address Filter
<b>Wired LAN Interface</b>	
Standard Compliance	IEEE802.3u (100BASE-TX), IEEE802.3 (10BASE-T)
Transmission Rate	10 / 100 Mbps
Transmission Encoding	100BASE-TX 4B5B/MLT-3, 10BASE-T Manchester Coding
Access Method	CSMA/CD
Speed and Flow Control	10 / 100 Mbps, Auto Sensing, Auto MDIX
Number of LAN Ports	4
LAN Port Connector	RJ-45
<b>DSL Interface</b>	
Standard Compliance	ADSL2+
Number of DSL Ports	1
DSL Port Connector	RJ-11
<b>Other</b>	
Power Supply	External AC 100-240 V Universal, 50/60 Hz
Power Consumption	About 18.0 W (Max)
Dimensions	165 mm x 128 mm x 29 mm (6.5 x 5.0 x 1.1 in.) (not including the antenna and stand)
Weight	202g (7.1 oz.) (not including the antenna and stand)
Operating Environment	0-40 °C (32-104 °F) , 10-85 % (non-condensing)

# Appendix B - Default Configuration Settings

Feature	Parameter	Default Setting
Internet	Encapsulation	RFC 1483 Bridged
	Modulation	MultiMode
	Multiplexing	LLC
	QoS Type	UBR
	PCR Rate	0 cps
	SCR Rate	0 cps
	Auto Detect	Disabled
	Virtual Circuit	0 VPI 35 VCI
	IP Settings	Obtain an IP Address Automatically
	Host Name	none
	Domain Name	none
	MTU	Auto
	Local IP Address	192.168.11.1
	Subnet Mask	255.255.255.0
	Local DHCP Server	Enabled
	Starting IP Address	192.168.11.64
	Maximum Number of DHCP Users	191
	Client Lease Time	2880 minutes
	Static DNS 1 - 3	0.0.0.0
WINS	0.0.0.0	
DDNS (Router Mode only)	DDNS Service	Disabled
	Current Dynamic DNS Information	none
Route	Routing Information	none

Feature	Parameter	Default Setting
WPS	WPS	Enabled
	External Registrar	Enabled
	AirStation PIN	An 8-digit random value (Printed on the label of the AirStation)
	WPS Security Information	WPS status: configured or unconfigured SSID: BUFFALO-XXXXXX (the last 6 digits of the AirStation's MAC address) Security: WPA/WPA2 mixedmode - PSK TKIP/AES mixedmode or none Encryption key: A 13-digit random value or disabled. (Printed on the label of the AirStation. Encryption is disabled by default settings on AirStation for Asia Pacific.)
AOSS	Encryption Type of Exclusive SSID for WEP	none
	Advanced Encryption Level feature	Enabled
	Exclusive SSID for WEP	Disabled
	AOSS Button on the AirStation Unit	Enabled
Basic	Wireless Radio	Enabled
	Wireless Channel	Auto Channel
	150 Mbps Mode	Band Width: 20MHz Extension Channel: -
	Broadcast SSID	Allow
	SSID	SSID1: Name SSID based on MAC address SSID2: Name SSID based on MAC address SSID3: not used SSID4: not used
	Separate feature	SSID1: not used SSID2: not used SSID3: not used SSID4: not used
	Wireless authentication	WPA/WPA2 mixedmode - PSK, or no authentication
	Wireless encryption	TKIP/AES mixedmode, or no encryption
	WPA-PSK (Pre-Shared Key)	A 13-digit random value or disabled (Printed on the label of the AirStation. Encryption is disabled in default settings on AirStation for Asia Pacific.)
	Rekey interval	60 minutes

Feature	Parameter	Default Setting		
Advanced	BSS Basic Rate Set	1, 2, 5.5, 11 Mbps		
	Multicast Rate	1 Mbps		
	Reverse Direction Grant	Enabled		
	DTIM Period	1		
	Privacy Separator	Disabled		
	Output Power	100 %		
	Tx Burst	Enabled		
WMM	WMM-EDCA Parameters (Priority AC_BK (Low) )		For AP	For STA
		CWmin	15	15
		CWmax	1023	1023
		AIFSN	7	7
		TXOP Limit	0	0
	WMM-EDCA Parameters (Priority AC_BE (Normal) )		For AP	For STA
		CWmin	15	15
		CWmax	63	1023
		AIFSN	3	3
		TXOP Limit	0	0
	WMM-EDCA Parameters (Priority AC_VI (High) )		For AP	For STA
		CWmin	7	7
		CWmax	15	15
		AIFSN	1	2
		TXOP Limit	94	94
	WMM-EDCA Parameters (Priority AC_VO (Highest) )		For AP	For STA
CWmin		3	3	
CWmax		7	7	
AIFSN		1	2	
TXOP Limit		47	47	
MAC Filter	Enforce MAC Filter	Disabled		
	Registration List	none		
Firewall (Router Mode only)	Log Output	Disabled		
	Basic Rules	Prohibit NBT and Microsoft-DS Routing	Disabled	
		Reject IDENT Requests	Enabled	
		Block Ping from Internet	Enabled	
IP Filter (Router Mode only)	Log Output	Disabled		
	IP Filter Information	none		

Feature	Parameter	Default Setting
VPN Pass Through (Router Mode only)	PPPoE Pass Through	Disabled
	PPTP Pass Through	Disabled
Port Forwarding (Router Mode only)	Port Forwarding Registration Information	none
DMZ (Router Mode only)	IP Address of DMZ	none
UPnP (Router Mode only)	UPnP	Enabled
QoS (Router Mode only)	QoS for transmission to the Internet	Disabled
Name	AirStation Name	AP + AirStation's MAC Address
Password	Administrator Name	root (fixed)
	Administrator Password	none
Time/Date	Local Date	2010 Year 1 Month 1 Day
	Local Time	0 Hour 0 Minute 0 Seconds
	Time Zone	(GMT+00:00) Greenwich Mean Time, London
NTP	NTP Functionality	Disabled
	NTP Server	time.nist.gov
	Update Interval	24 hours
ECO	Schedule Feature	Disabled
	Register schedule	Operational Mode: Normal Start time: 0:00 End time: 0:30 The day of week: none
	User Define Mode	LED: Off Wired LAN: ECO (Slow operation) Wireless LAN: Off
Access	Log Output	Disable
	Limitation Item	Prohibit configuration from wireless LAN Disabled Prohibit configuration from wired LAN Disabled Permit configuration from wired Internet Disabled

<b>Feature</b>	<b>Parameter</b>	<b>Default Setting</b>
Log	Log Transfer	Disabled
	Syslog Server	none
	Transfer Logs	Address Translation, IP Filter, Firewall, PPPoE Client, Dynamic DNS, DHCP Client, DHCP Server, AOSS, Wireless Client, Authentication, Setting Changes, System Boot, NTP Client, and Wired Link

# Appendix C - TCP/IP Settings

## Windows 7

---

To configure TCP/IP in Windows 7, follow the procedure below.

- 1** Click [Start] > [Control Panel] > [Network and Internet].
- 2** Click [Network and Sharing Center].
- 3** Click [Change Adapter Settings] on the left side menu.
- 4** Right-click on [Local Area Connection], then click [Properties].
- 5** If the User Account Control screen opens, click [Yes] or [Continue].
- 6** Select [Internet Protocol Version 4 (TCP/IPv4)] then click [Properties].
- 7** To have DHCP set your IP address settings automatically, check [Obtain an IP address automatically] and [Obtain DNS server address automatically].

To set your IP address settings manually, enter values for each setting. Examples:

If the router's IP address is 192.168.11.1,	
IP address	192.168.11.80
Subnet mask	255.255.255.0
Default gateway	192.168.11.1
Preferred DNS server	192.168.11.1
Alternate DNS server	blank

- 8** Click [OK].



## Windows Vista

---

To configure TCP/IP in Windows Vista, follow the procedure below.

- 1** Click [Start] > [Settings] > [Control Panel].
- 2** Click [Network and Sharing Center].
- 3** Click [Manage network connections] on the left side menu.
- 4** Right-click on [Local Area Connection], then click [Properties].
- 5** If the User Account Control screen opens, click [Yes] or [Continue].
- 6** Select [Internet Protocol Version 4 (TCP/IPv4)], then click [Properties].
- 7** To have DHCP set your IP address settings automatically, check [Obtain an IP address automatically] and [Obtain DNS server address automatically].

To set your IP address settings manually, enter values for each settings. Example:

If the router's IP address is 192.168.11.1,	
IP address	192.168.11.80
Subnet mask	255.255.255.0
Default gateway	192.168.11.1
Preferred DNS server	192.168.11.1
Alternate DNS server	blank

- 8** Click [Close].

## Windows XP

---

To configure TCP/IP in Windows XP, follow the procedure below.

- 1** Click [Start] > [Settings] > [Control Panel].
- 2** Double-click [Network].
- 3** Right click on [Local Area Connection], then click [Properties].
- 4** Select [Internet Protocol (TCP/IP)], then click [Properties].
- 5** To have DHCP set your IP address settings automatically, check [Obtain an IP address automatically] and [Obtain DNS server address automatically].

To set your IP address settings manually, enter values for each setting. Examples:

If the router's IP address is 192.168.11.1,	
IP address	192.168.11.80
Subnet mask	255.255.255.0
Default gateway	192.168.11.1
Preferred DNS server	192.168.11.1
Alternate DNS server	blank

- 6** Click [Close].

## Mac OS X

---

To configure TCP/IP in Mac OS X, follow the procedure below.

- 1** Click [Apple menu] > [System Preferences...].
- 2** Click [Network].
- 3** Click [Ethernet].
- 4** To have DHCP set your IP address settings automatically, select [Using DHCP] in the Configure IPv4 field.

To set your IP address settings manually, select [Manually] in the Configure IPv4 field and enter values for each setting. Examples:

If the router's IP address is 192.168.11.1,	
IP Address	192.168.11.80
Subnet Mask	255.255.255.0
Router	192.168.11.1
DNS Server	192.168.11.1
Search Domains	blank

- 5** Click [Apply].

## Appendix D - Restoring the Default Configuration

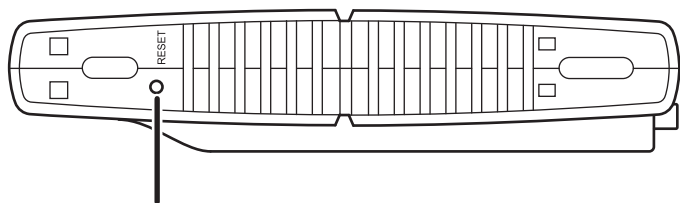

With the AirStation powered on, hold down this button for 3 seconds to return it to factory default settings.

# Appendix E - Regulatory Compliance Information

## Federal Communication Commission Interference Statement

This equipment has been tested and found to comply with the limits for a Class B digital device, pursuant to Part 15 of the FCC Rules. These limits are designed to provide reasonable protection against harmful interference in a residential installation. This equipment generates, uses and can radiate radio frequency energy and, if not installed and used in accordance with the instructions, may cause harmful interference to radio communications. However, there is no guarantee that interference will not occur in a particular installation. If this equipment does cause harmful interference to radio or television reception, which can be determined by turning the equipment off and on, the user is encouraged to try to correct the interference by one of the following measures:

- Reorient or relocate the receiving antenna.
- Increase the separation between the equipment and receiver.
- Connect the equipment into an outlet on a circuit different from that to which the receiver is connected.
- Consult the dealer or an experienced radio/TV technician for help.

## FCC Caution:

Any changes or modifications not expressly approved by the party responsible for compliance could void the user's authority to operate the equipment.

This device complies with Part 15 of the FCC Rules. Operation is subject to the following two conditions: (1) This device may not cause harmful interference, and (2) this device must accept any interference received, including interference that may cause undesired operation.

## Important Note - FCC Radiation Exposure Statement:

This equipment complies with FCC radiation exposure limits set forth for uncontrolled equipment. This equipment should be installed and operated with minimum distance 20cm between the radiator and your body.

This transmitter must not be co-located or operating in conjunction with any other antenna or transmitter.

The availability of some specific channels and/or operational frequency bands are country dependent and are firmware programmed at the factory to match the intended destination. The firmware setting is not accessible by the end user.

## Europe – EU Declaration of Conformity

This device complies with the essential requirements of the R&TTE Directive 1999/5/EC. The following test methods have been applied in order to prove presumption of conformity with the essential requirements of the R&TTE Directive 1999/5/EC:

EN60950-1: 2006 +A11: 2009

Safety of Information Technology Equipment

EN 50385: 2002

Product standard to demonstrate the compliance of radio base stations and fixed terminal stations for wireless telecommunication systems with the basic restrictions or the reference levels related to human exposure to radio frequency electromagnetic fields (110MHz - 40 GHz) - General public

EN 300 328 V1.7.1 (2006-10)

Electromagnetic compatibility and Radio spectrum Matters (ERM); Wideband transmission systems; Data transmission equipment operating in the 2,4 GHz ISM band and using wide band modulation techniques; Harmonized EN covering essential requirements under article 3.2 of the R&TTE Directive

EN 301 489-1 V1.8.1 (2008-04)

Electromagnetic compatibility and Radio Spectrum Matters (ERM); ElectroMagnetic Compatibility (EMC) standard for radio equipment and services; Part 1: Common technical requirements

EN 301 489-17 V2.1.1 (2009-05)

Electromagnetic compatibility and Radio spectrum Matters (ERM); ElectroMagnetic Compatibility (EMC) standard for radio equipment and services; Part 17: Specific conditions for 2,4 GHz wideband transmission systems , 5 GHz high performance RLAN equipment and 5,8GHz Broadband Data Transmitting Systems.

This device is a 2.4 GHz wideband transmission system (transceiver), intended for use in all EU member states and EFTA countries, except in France and Italy where restrictive use applies.

In Italy the end-user should apply for a license at the national spectrum authorities in order to obtain authorization to use the device for setting up outdoor radio links and/or for supplying public access to telecommunications and/or network services.

This device may not be used for setting up outdoor radio links in France and in some areas the RF output power may be limited to 10 mW EIRP in the frequency range of 2454 – 2483.5 MHz. For detailed information the end-user should contact the national spectrum authority in France.



Česky [Czech]

Buffalo Technology Inc. tímto prohlašuje, že tento AirStation WBMR-HP-GNV2 je ve shodě se základními požadavky a dalšími příslušnými ustanoveními směrnice 1999/5/ES.

Dansk [Danish]

Undertegnede Buffalo Technology Inc. erklærer herved, at følgende udstyr AirStation WBMR-HP-GNV2 overholder de væsentlige krav og øvrige relevante krav i direktiv 1999/5/EF.

Deutsch [German]

Hiermit erklärt Buffalo Technology Inc. dass sich das Gerät AirStation WBMR-HP-GNV2 in Übereinstimmung mit den grundlegenden Anforderungen und den übrigen einschlägigen Bestimmungen der Richtlinie 1999/5/EG befindet.

Eesti [Estonian]

Käesolevaga kinnitab Buffalo Technology Inc. seadme AirStation WBMR-HP-GNV2 vastavust direktiivi 1999/5/EÜ põhinõuetele ja nimetatud direktiivist tulenevatele teistele asjakohastele sätetele.

English

Hereby, Buffalo Technology Inc. declares that this AirStation WBMR-HP-GNV2 is in compliance with the essential requirements and other relevant provisions of Directive 1999/5/EC.

Español [Spanish]

Por medio de la presente Buffalo Technology Inc. declara que el AirStation WBMR-HP-GNV2 cumple con los requisitos esenciales y cualesquiera otras disposiciones aplicables o exigibles de la Directiva 1999/5/CE.

Ελληνική [Greek]

ΜΕ ΤΗΝ ΠΑΡΟΥΣΑ Buffalo Technology Inc. ΔΗΛΩΝΕΙ ΟΤΙ AirStation WBMR-HP-GNV2 ΣΥΜΜΟΡΦΩΝΕΤΑΙ ΠΡΟΣ ΤΙΣ ΟΥΣΙΩΔΕΙΣ ΑΠΑΙΤΗΣΕΙΣ ΚΑΙ ΤΙΣ ΛΟΙΠΕΣ ΣΧΕΤΙΚΕΣ ΔΙΑΤΑΞΕΙΣ ΤΗΣ ΟΔΗΓΙΑΣ 1999/5/ΕΚ.

Français [French]

Par la présente Buffalo Technology Inc. déclare que l'appareil AirStation WBMR-HP-GNV2 est conforme aux exigences essentielles et aux autres dispositions pertinentes de la directive 1999/5/CE.

Italiano [Italian]

Con la presente Buffalo Technology Inc. dichiara che questo AirStation WBMR-HP-GNV2 è conforme ai requisiti essenziali ed alle altre disposizioni pertinenti stabilite dalla direttiva 1999/5/CE.

Latviski [Latvian]

Ar šo Buffalo Technology Inc. deklarē, ka AirStation WBMR-HP-GNV2 atbilst Direktīvas 1999/5/EK būtiskajām prasībām un citiem ar to saistītajiem noteikumiem.

Lietuvių [Lithuanian]

Šiuo Buffalo Technology Inc. deklaruoją, kad šis AirStation WBMR-HP-GNV2 atitinka esminius reikalavimus ir kitas 1999/5/EB Direktyvos nuostatas.

Nederlands [Dutch]

Hierbij verklaart Buffalo Technology Inc. dat het toestel AirStation WBMR-HP-GNV2 in overeenstemming is met de essentiële eisen en de andere relevante bepalingen van richtlijn 1999/5/EG.

Malti [Maltese]

Hawnhekk, Buffalo Technology Inc. , jiddikjara li dan AirStation WBMR-HP-GNV2 jikkonforma mal-ħtiġijiet essenzjali u ma provvedimenti oħrajn relevanti li hemm fid-Dirrettiva 1999/5/EC.

Magyar [Hungarian]

Alulírott, Buffalo Technology Inc. nyilatkozom, hogy a AirStation WBMR-HP-GNV2 megfelel a vonatkozó alapvető követelményeknek és az 1999/5/EC irányelv egyéb előírásainak.

Polski [Polish]

Niniejszym, Buffalo Technology Inc. , deklaruję, że AirStation WBMR-HP-GNV2 spełnia wymagania zasadnicze oraz stosowne postanowienia zawarte Dyrektywie 1999/5/EC.

Português [Portuguese]

Buffalo Technology Inc. declara que este AirStation WBMR-HP-GNV2 está conforme com os requisitos essenciais e outras disposições da Directiva 1999/5/CE.

Slovensko [Slovenian]

Buffalo Technology Inc. izjavlja, da je ta AirStation WBMR-HP-GNV2 v skladu z bistvenimi zahtevami in ostalimi relevantnimi določili direktive 1999/5/ES.

Slovensky [Slovak]

Buffalo Technology Inc. týmto vyhlasuje, že AirStation WBMR-HP-GNV2 spĺňa základné požiadavky a všetky príslušné ustanovenia Smernice 1999/5/ES.

Suomi [Finnish]

Buffalo Technology Inc. vakuuttaa täten että AirStation WBMR-HP-GNV2 tyyppinen laite on direktiivin 1999/5/EY oleellisten vaatimusten ja sitä koskevien direktiivin muiden ehtojen mukainen.

Svensk [Swedish]

Härmed intygar Buffalo Technology Inc. att denna AirStation WBMR-HP-GNV2 står i överensstämmelse med de väsentliga egenskapskrav och övriga relevanta bestämmelser som framgår av direktiv 1999/5/EG.



# Appendix F - Environmental Information

- The equipment that you have purchased has required the extraction and use of natural resources for its production.
- The equipment may contain hazardous substances that could impact health and the environment.
- In order to avoid the dissemination of those substances in our environment and to diminish the pressure on the natural resources, we encourage you to use the appropriate take-back systems.
- The take-back systems will reuse or recycle most of the materials of your end life equipment in a sound way.
- The crossed-out wheeled bin symbol invites you to use those systems.



- If you need more information on the collection, reuse and recycling systems, please contact your local or regional waste administration.

# Appendix G - GPL Information

The source code for Buffalo products that use GPL code is available at <http://opensource.buffalo.jp/>.

# Appendix H - Warranty Information

Buffalo Technology (Buffalo Inc.) products come with a two-year limited warranty from the date of purchase. Buffalo Technology (Buffalo Inc.) warrants to the original purchaser the product; good operating condition for the warranty period. This warranty does not include non-Buffalo Technology (Buffalo Inc.) installed components. If the Buffalo product malfunctions during the warranty period, Buffalo Technology/(Buffalo Inc.) will, replace the unit, provided the unit has not been subjected to misuse, abuse, or non-Buffalo Technology/(Buffalo Inc.) authorized alteration, modifications or repair.

All expressed and implied warranties for the Buffalo Technology (Buffalo Inc) product line including, but not limited to, the warranties of merchantability and fitness of a particular purpose are limited in duration to the above period.

Under no circumstances shall Buffalo Technology/(Buffalo Inc.) be liable in any way to the user for damages, including any lost profits, lost savings or other incidental or consequential damages arising out of the use of, or inability to use the Buffalo products.

In no event shall Buffalo Technology/(Buffalo Inc.) liability exceed the price paid for the product from direct, indirect, special, incidental, or consequential damages resulting from the use of the product, its accompanying software, or its documentation. Buffalo Technology (Buffalo Inc.) does not offer refunds for any product.

@ 2003-2010 Buffalo Technology (Buffalo, Inc.)