

**BELKIN**

# Wireless Router

*Share your broadband Internet connection  
without running cables*



**User Manual**

F5D7230-4

## TABLE OF CONTENTS

Introduction . . . . .	1
Key Features . . . . .	1
Package Contents . . . . .	4
System Requirements . . . . .	5
Easy Install Wizard Software System Requirements . . . . .	5
Knowing your Router . . . . .	6
Placement of your Router . . . . .	10
Connecting and Configuring your Router . . . . .	11
Alternate Setup Method . . . . .	24
Using the Web-Based Advanced User Interface . . . . .	40
Manually Configuring Network Settings . . . . .	79
Recommended Web Browser Settings . . . . .	84
Troubleshooting . . . . .	87
Information . . . . .	92

# INTRODUCTION

Thank you for purchasing the Belkin Cable/DSL Gateway Router (the Router). In minutes you will be able to share your Internet connection and network your computers. The following is a list of features that make your new Router an ideal solution for your home or small office network.

## Key Features

### Easy Install Wizard

The Easy Install Wizard takes the guesswork out of setting up your Router. This automatic software determines your network settings for you and sets up the Router for connection to your Internet Service Provider (ISP). In a matter of minutes, your Router will be up and running on the Internet.

**NOTE:** *Easy Install Wizard software is compatible with Windows 98, Me, 2000, and XP. If you are using another operating system, the Router can be set up using the Alternative Method described in this manual.*

### Integrated 802.11g Wireless Access Point

802.11g is an exciting new wireless technology that achieves data rates up to 54Mbps, nearly five times faster than 802.11b.

### Integrated Parental Control Web Content Filter

Belkin has teamed with Cerberian, a leading content-filtering company, to bring you this unique feature. Your Router is the first home networking solution with an integrated web content filter that allows you to block unwanted or offensive web content before it makes it to your network. Unlike other Parental Control solutions, Parental Control is built into the Belkin Router, so there is no software to install on any computer and you will never be charged a per-computer fee for the service, ever. Your Router comes with a six-month free trial of this feature so you can take advantage of the capabilities right away. No credit card is needed to use the trial. You have control: Belkin Parental Control can be modified to meet your needs. You can set up your own policies and block any website you want. There is also an optional reporting feature (fee-based) that allows you to get a report showing you every website that was visited from your network.

# INTRODUCTION

## **Works with Both PCs and Mac® Computers**

The Router supports a variety of networking environments including Mac® OS 8.x, 9.x, X v10.x, AppleTalk®, Linux®, Windows® 95, 98, Me, NT®, 2000, and XP, and others. All that is needed is an Internet browser and a network adapter that supports TCP/IP (the standard language of the Internet).

## **Front-Panel Connected LED Display**

Lighted LEDs on the front of the Router indicate which functions are in operation. You'll know at-a-glance whether your Router is connected to the Internet. This feature eliminates the need for advanced software and status-monitoring procedures.

## **Vertical or Horizontal Desktop Application**

Your Router can stand vertically on the desktop to save space, or lay down flat on a shelf or under your modem. The included vertical mounting base lets you decide how to position the Router.

## **Web-Based Advanced User Interface**

You can set up the Router's advanced functions easily through your web browser, without having to install additional software onto the computer. There are no disks to install or keep track of and, best of all, you can make changes and perform setup functions from any computer on the network quickly and easily.

## **NAT IP Address Sharing**

Your Router employs Network Address Translation (NAT) to share the single IP address assigned to you by your Internet Service Provider while saving the cost of adding additional IP addresses to your Internet service account.

# INTRODUCTION

## **SPI Firewall**

Your Router is equipped with a firewall that will protect your network from a wide array of common hacker attacks including IP Spoofing, Land Attack, Ping of Death (PoD), Denial of Service (DoS), IP with zero length, Smurf Attack, TCP Null Scan, SYN flood, UDP flooding, Tear Drop Attack, ICMP defect, RIP defect, and fragment flooding.

## **Integrated 10/100 4-Port Switch**

The Router has a built-in, 4-port network switch to allow your wired computers to share printers, data and MP3 files, digital photos, and much more. The switch features automatic detection so it will adjust to the speed of connected devices. The switch will transfer data between computers and the Internet simultaneously without interrupting or consuming resources.

## **Universal Plug-and-Play (UPnP) Compatibility**

UPnP (Universal Plug-and-Play) is a technology that offers seamless operation of voice messaging, video messaging, games, and other applications that are UPnP-compliant.

## **Support for VPN Pass-Through**

If you connect to your office network from home using a VPN connection, your Router will allow your VPN-equipped computer to pass through the Router and to your office network.

**Built-In Dynamic Host Configuration Protocol (DHCP)** on-board makes for the easiest possible connection of a network. The DHCP server will assign IP addresses to each computer automatically so there is no need for a complicated networking setup.

# INTRODUCTION

## **MAC Address Filtering**

For added security, you can set up a list of MAC addresses (unique client identifiers) that are allowed access to your network. Every computer has its own MAC address. Simply enter these MAC addresses into a list using the web-based user interface and you can control access to your network.

## **Applications and Advantages**

- Economically connect multiple computers to a single Internet connection
- SOHO (Small Office/Home Office) networking needs
- Provides the easy and quick small network installation SOHO users need.

## **Package Contents**

- Belkin 54g Wireless Cable/DSL Gateway Router
- Vertical Mounting Base (optional use)
- Category 5 Networking cable
- Power Supply
- Belkin Easy Install Wizard Software CD
- User Manual
- Warranty Card

## **System Requirements**

- Broadband Internet connection such as a cable or DSL modem with RJ45 (Ethernet) connection
- At least one computer with an installed network interface adapter
- TCP/IP networking protocol installed on each computer
- CAT5 networking cable (or better)
- Microsoft® Internet Explorer 4.0 or later, or Netscape® 4.0 or later

## **Easy Install Wizard Software System Requirements**

- A PC running Windows 98, Me, 2000, or XP or a Mac® running OS 9.x or OS X
- Minimum 64MB RAM
- Internet Browser

## KNOWING YOUR ROUTER

The Router has been designed to be placed on a desktop vertically or horizontally, or it may be mounted to a wall. The slim design minimizes the desktop space required when placed vertically. All of the cables exit from the rear of the Router for better organization and utility. The LED indicators are easily visible on the front of the Router to provide you with information about network activity and status.

### 1. Power/Ready LED

When you apply power to the Router or restart it, a short period of time elapses while the Router boots up. During this time, the “Power/Ready” LED blinks. When the Router has completely booted up, the Power/Ready LED becomes a SOLID light, indicating the Router is ready for use.

OFF	Router is OFF
Blinking Green	Router is Booting Up
Solid Green	Router is Ready

### 2. Wireless Network LED

OFF	Wireless Network is OFF
Green	Wireless Network is Ready
Blinking	Indicates Wireless Activity

### 3. LAN Port-Status LEDs

These LEDs are labeled 1–4 and correspond to the numbered ports on the rear of the Router. When a computer is properly connected to one of the LAN ports on the rear of the Router, the LED will light. GREEN means a 10Base-T device is connected, AMBER means a 100Base-Tx device is connected. When information is being sent over the port, the LED blinks rapidly.

OFF	No Device is Linked to the Port
Green	10Base-T Device Connected
Orange	100Base-Tx Device Connected
Blinking (Orange or Green)	Port Activity



## KNOWING YOUR ROUTER

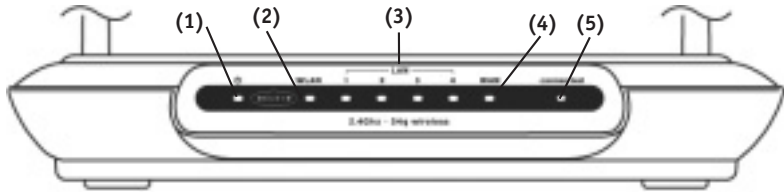

### 4. WAN Status LED

This LED lights in GREEN to indicate that your modem is connected properly to the Router. It blinks rapidly when information is being sent over the port between the Router and the modem.

OFF	No WAN Link
Solid Green	Good WAN Link
Blinking Green	WAN Activity

### 5. Connected LED

This unique LED shows you when the Router is connected to the Internet. When the light is OFF, the Router is NOT connected to the Internet. When the light is blinking, the Router is attempting to connect to the Internet. When the light is solid GREEN, the Router is connected to the Internet. When using the "Disconnect after x minutes" feature, this LED becomes extremely useful in monitoring the status of your Router's connection.

OFF	Router is not Connected to the Internet
Blinking Green	Router is Attempting to Connect to the Internet
Solid Green	Router is Connected to the Internet

## KNOWING YOUR ROUTER

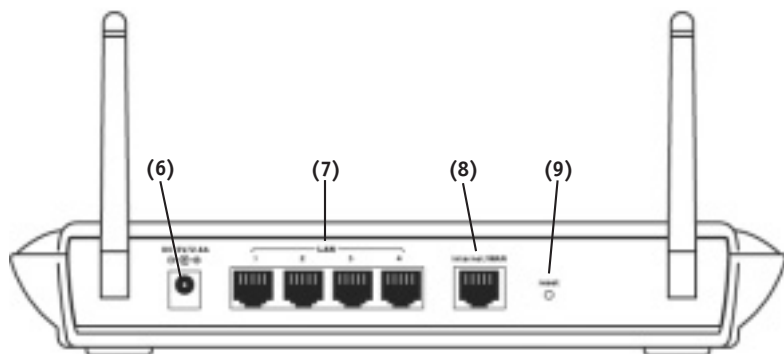

### 6. Power Jack

Connect the included 5V DC power supply to this jack.

### 7. LAN Ports

The LAN ports are RJ45, 10/100 auto-negotiation, auto-uplinking ports for standard UTP category 5 or 6 Ethernet cable. The ports are labeled 1 through 4. These ports correspond to the numbered LEDs on the front of the Router.

### 8. Internet/WAN Port

This port is for connection to your cable or DSL modem. Use the cable that was provided with the modem to connect the modem to this port. Use of a cable other than the cable supplied with the cable modem may not work properly.

### 9. Reset Button

The “Reset” button is used in rare cases when the Router may function improperly. Resetting the Router will restore the Router’s normal operation while maintaining the programmed settings. You can also restore the factory default settings by using the Reset button. Use the restore option in instances where you may have forgotten your custom password.

#### a. Resetting the Router

Push and release the Reset button. The lights on the Router will momentarily flash. The Power/Ready light will begin to blink. When the Power/Ready light becomes solid again, the reset is complete.

#### b. Restoring the Factory Defaults

Press and hold the Reset button for five seconds then release it. The lights on the Router will momentarily flash. The Power/Ready light will begin to blink. When the Power/Ready light becomes solid again, the restore is complete.

## PLACEMENT OF YOUR ROUTER

Proper placement of your Router is important to ensure the best performance of your wireless network. Typically, indoors your Wireless Router can provide a circular coverage area of 250 feet or more. However, different types of construction materials and other obstructions in a building can greatly affect the wireless signal and decrease the range. Whenever possible, your Router should be placed as close as possible to the center of the area that you want to cover. In multi-story homes, place the Router on a floor that is as close to the center of the home as possible; this may mean placing the Router on an upper floor.

Use care when choosing the location of your Router

- Be aware of appliances or large objects such as a refrigerator or washer/dryer unit that may be on the opposite side of a wall from where you decide to place your Router.
- Place the Router on top of a desk and away from metal cabinets and computer cases.
- Do not place objects or components on top of the Router.
- Make sure that both antennas are pointing UP at all times.
- Metallic-based UV window tint can affect wireless performance. Do not place the Router next to a tinted window.

We realize that in the real world, it may not be possible to place your Router in the center of your coverage area. In cases where you may experience difficulty covering the entire area you want, try placing the Router as high as possible. Wireless devices work best in a line-of-sight situation where there are no obstacles between the wireless computer and the Router. The Router may also be mounted to a wall with the antennas facing UP. There are other options for expanding your wireless coverage area. Visit [www.networking.belkin.com](http://www.networking.belkin.com) for solutions.

The wireless signal can be affected by many things including neighboring wireless networks, microwave ovens in operation, and 2.4GHz cordless phones. While these things can affect the network performance, your wireless network typically will work fine under most conditions where these devices exist.

## CONNECTING AND CONFIGURING YOUR ROUTER

Verify the contents of your box. You should have the following:

- Belkin Cable/DSL Gateway Router
- Vertical Mounting Base (optional use)
- Category 5 Networking Cable (for connection of the Router to the computer)
- Power Supply
- Belkin Easy Install Wizard Software CD
- User Manual
- Warranty Card

### Modem Requirements

Your cable or DSL modem must be equipped with an RJ45 Ethernet port. Many modems have both an RJ45 Ethernet port and a USB connection. If you have a modem with both Ethernet and USB, and are using the USB connection at this time, you will be instructed to use the RJ45 Ethernet port during the installation procedure. If your modem has only a USB port, you can request a different type of modem from your ISP, or you can, in some cases, purchase a modem that has an RJ45 Ethernet port on it.



**Ethernet**



**USB**

## CONNECTING AND CONFIGURING YOUR ROUTER

### Easy Install Wizard

Belkin has provided our Easy Install Wizard software to make installing your Router a simple and easy task. You can use it to get your Router up and running in minutes. The Easy Install Wizard requires that your Windows 98, Me, 2000, or XP computer be connected directly to your cable or DSL modem and that the Internet connection is active and working at the time of installation. If it is not, you must use the “Alternate Setup Method” section of this manual to configure your Router. Additionally, if you are using an operating system other than Windows 98, Me, 2000, or XP, you must set up the Router using the “Alternate Setup Method” section of this manual.

**IMPORTANT:** Run the Easy Install Wizard from the computer that is directly connected to the cable or DSL modem.  
**DO NOT CONNECT THE ROUTER AT THIS TIME.**

### Step 1: Run the Easy Install Wizard Software

1. Shut down any programs that are running on your computer at this time.
2. Make sure you have the following items at the computer that is now directly connected to the cable or DSL modem. **DO NOT CONNECT THE ROUTER AT THIS TIME.**
  - The Easy Install Wizard CD-ROM
  - The Router
  - The Router power supply
  - Category 5 networking cable
  - This User Manual
3. Turn off any firewall or Internet connection sharing software on your computer.
4. Insert the Easy Install Wizard software CD into your CD-ROM Drive. The Easy Installation Wizard screen will automatically appear on your screen within 15 seconds. If it does not, select your CD-ROM drive from “My Computer” and double-click on the file named “Setup” on the CD-ROM.

# CONNECTING AND CONFIGURING YOUR ROUTER

## Step 2: Follow the Easy Install Wizard to Complete the Installation

2.1 Click on “Set Up the Router” to begin.



## 2.2 Welcome Screen

The Wizard welcome screen will appear. Make sure you have not connected the Router at this point. If you have connected your Router, please reconnect your computer directly to the modem. Click “Next” when you are ready to move on.

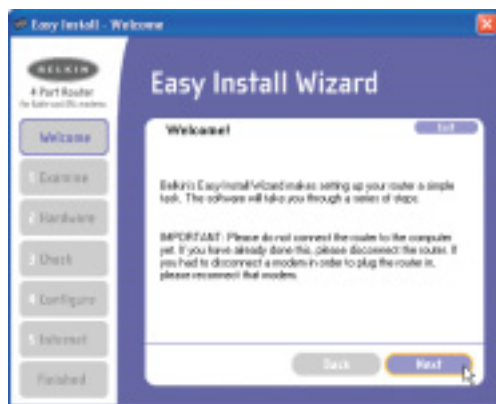

# CONNECTING AND CONFIGURING YOUR ROUTER

## 2.3 License Agreement

Please read the license agreement in the window. When you are finished, select “I agree” if you want to continue using the software. Click “I disagree” if you do not want to continue. Click “Next” to move on.

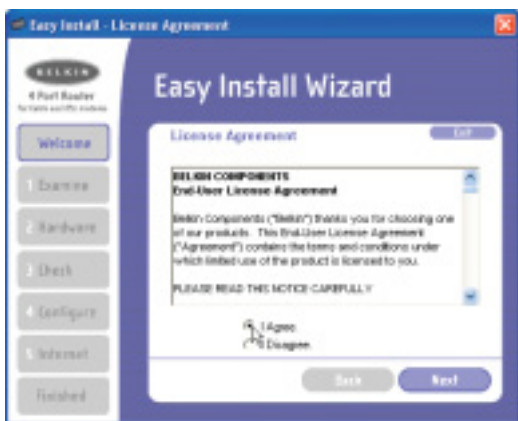

## 2.4 Examining Settings

The Wizard will now examine your computer's settings and gather information needed to complete the Router's connection to the Internet.

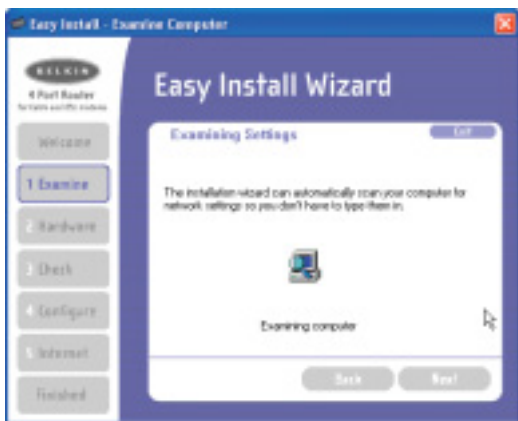



# CONNECTING AND CONFIGURING YOUR ROUTER

## 2.5 Multi-NICs Screen

This screen will appear ONLY if you have more than one network adapter installed in your computer. If you have more than one network adapter installed in your computer, the Wizard will need to know which adapter is connected to your modem. Select the network card that is connected to your modem from the list and click “Next”. If you are not sure which adapter to choose, select the adapter at the top of the list. If you mistakenly choose the wrong adapter now, you will be able to choose a different one later.

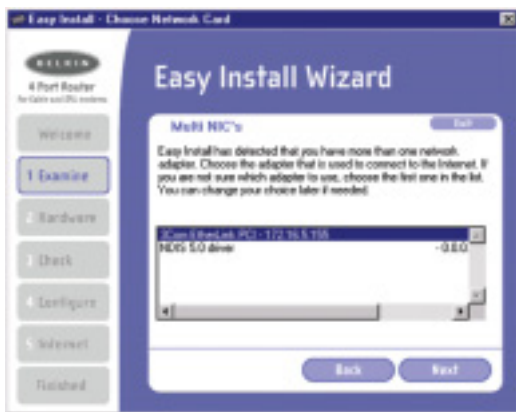

# CONNECTING AND CONFIGURING YOUR ROUTER

## 2.6 PPPoE Connection Detected

If you have a connection type that requires a user name and a password, the Wizard will ask you to type in your user name and password. If your connection type does not require a user name and password, you will not see this screen.

Your user name and password is provided to you by your Internet Service Provider. If you have to type in a user name and password to connect to the Internet, then type that same user name and password in here. Your user name looks something like “myname@myISP.com” or simply “myname”. The service name is optional and is very rarely required by your ISP. If you don’t know your service name, leave this blank. When you have entered your information, click “Next” to move on.

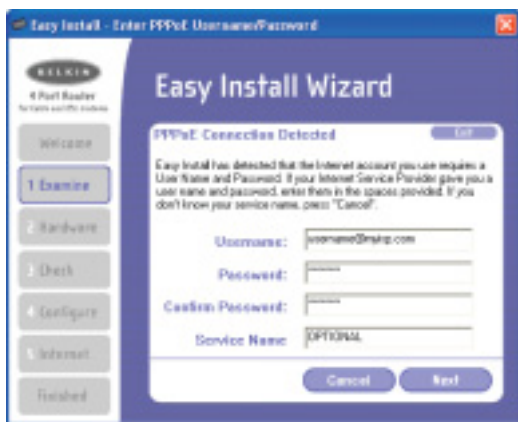

## CONNECTING AND CONFIGURING YOUR ROUTER

### Step 3: Connect the Router to your Modem and Computer

The Wizard will ask you to connect your Router. Follow the steps on the screen, or do the following:

- 3.1** Turn off the power to your modem by unplugging the power supply from the modem.
- 3.2** Locate the network cable that is connected between your modem and your computer and unplug it from your computer, leaving the other end connected to your modem.
- 3.3** Plug the loose end of the cable you just unplugged into the port on the back of the Router labeled "Internet/WAN".
- 3.4** Connect the new network cable from the back of the computer to one of the ports labeled "1-4". *Note: It does not matter which numbered port you choose.*
- 3.5** Turn on your cable or DSL modem by reconnecting the power supply to the modem.
- 3.6** Before plugging the power cord into the Router, plug the cord into the wall, then plug the cord into the Router's power jack.

Computer that was originally connected to the cable or DSL modem

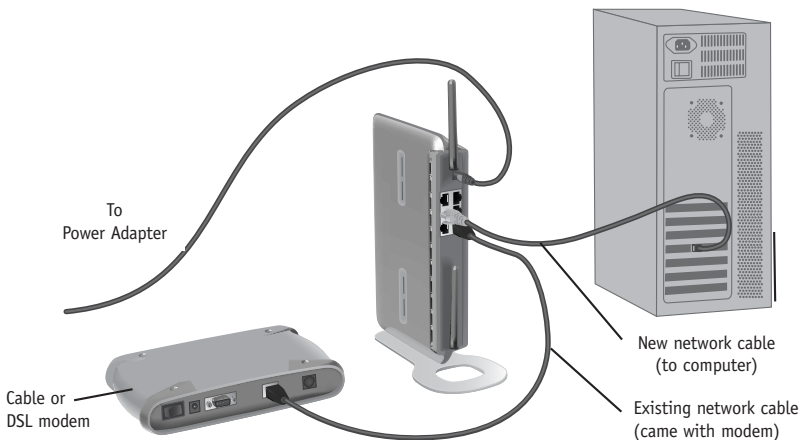

## CONNECTING AND CONFIGURING YOUR ROUTER

- 3.7 Verify that your modem is connected to the Router by checking the lights on the front of the Router. The green light labeled “WAN” should be ON if your modem is connected correctly to the Router. If it is not, recheck your connections.
- 3.8 Verify that your computer is connected properly to the Router by checking the lights labeled “LAN 1,2,3,4”. The light which corresponds to the numbered port that you connected your computer to should be ON if your computer is connected properly.

### Step 4: Continue Following the Wizard’s Instructions

#### 4.1 Checking the Connection

Once you have completed the connection of your Router, the Wizard will check the connection to the Router. If the Router is not detected, use the “Troubleshooting” button or refer to the “Troubleshooting” section of this guide to obtain help about how to correct the problem. If the Wizard is able to communicate with the Router, the Wizard will move on to the next step.

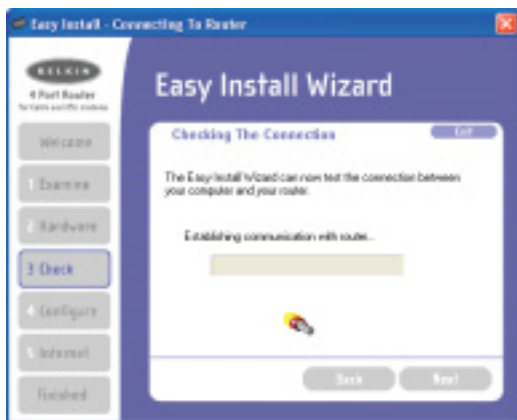

# CONNECTING AND CONFIGURING YOUR ROUTER

## 4.2 Configuring the Router

The Wizard will now transfer all of the configuration information to the Router. This will take approximately one minute.

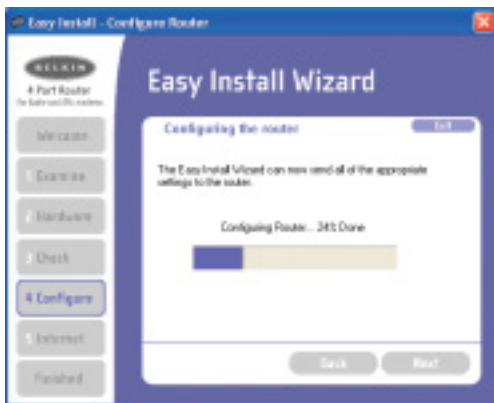

4.3 When the transfer is complete, the Wizard will tell you that it is done and may reboot (restart) the Router.

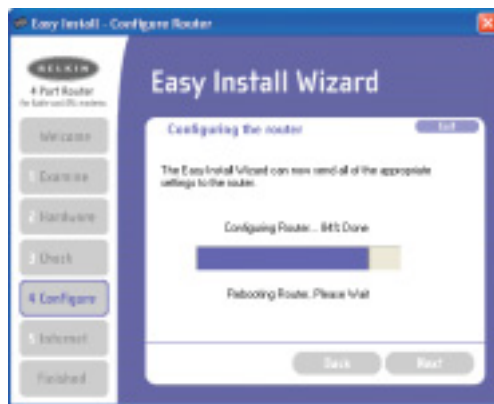

## CONNECTING AND CONFIGURING YOUR ROUTER

- 4.4 When configuration is complete, the Wizard will tell you “Router Setup Complete” and it will move to the next step.

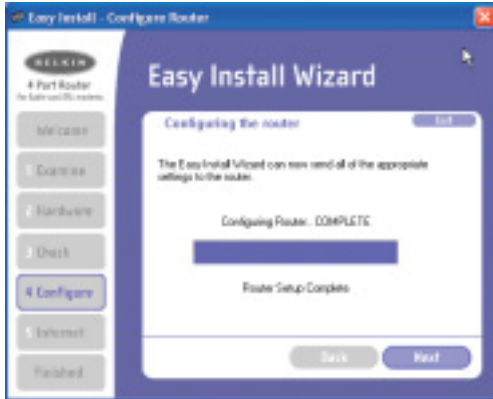

### 4.5 Checking Internet

The Wizard will now check for an Internet connection. This can take a few minutes. The Wizard may not detect a connection right away. If not, it will retry a number of times. The “Connected” light on the front panel of the Router will flash during this time. Please be patient through this process. If at the end of this process the Wizard cannot connect to the Internet, use the Troubleshooting button or refer to the Troubleshooting section of this guide to obtain help about how to correct the problem.

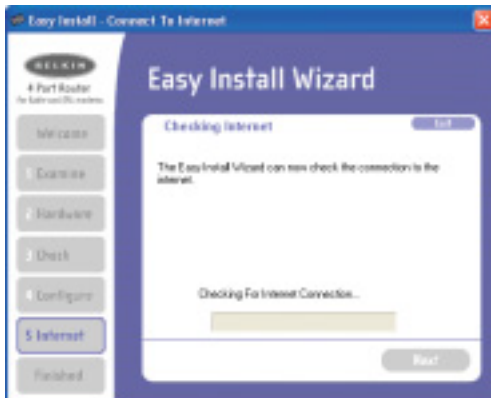

## CONNECTING AND CONFIGURING YOUR ROUTER

### 4.6 Finished

When the Internet connection is complete, the Wizard will tell you that you are finished. The “Connected” LED on the front of the Router will be solid GREEN, indicating that the Router is now connected to the Internet.



Your Router is now connected to the Internet. Now you can begin surfing the Internet by opening your browser and going to your favorite web page.

Congratulations! You have finished installing your new Belkin Router. You are ready to set up the other computers in your home. You can also add computers to your Router any time you want. Simply follow step 5 on the next page to learn how to add more computers.

### **Step 5: Adding Other Computers to your Network Using the Easy Install Wizard**

If you have other computers in your home that are already equipped with a wired or wireless network adapter, you can use the Easy Install Wizard to set up those computers to connect to your Router. If you are adding a Belkin wired or wireless network adapter to your other computers, install the adapter per the instructions for the adapter. When the installation of the adapter is finished, your computer will be set up to connect to the Router. You do not need to use the Easy Install Wizard to set up the computer.

#### **For Computers Already Equipped with a Wired or Wireless Network Adapter**

- 5.1** For wired computers, connect an Ethernet cable between the computer you want to add to the network and the Router. For wireless-equipped computers, make sure your wireless adapter is installed and working. Set your wireless adapter to connect to a wireless network SSID named "WLAN" or "ANY". In many cases you will find that you do not have to make any changes. Refer to the documentation of your wireless network adapter for information on making this change. Go to the next step.
- 5.2** Insert the CD into your CD-ROM drive. The Easy Installation Wizard screen will automatically pop-up on your screen within 15 seconds. If it does not, select your CD-ROM drive and double-click on the file named "Setup" on the CD-ROM.



## CONNECTING AND CONFIGURING YOUR ROUTER

5.3 Click “Add computers”.



5.4 The Wizard will make the changes needed to add your computer to the network. When finished, it will prompt to reboot your computer. Click “Yes”.

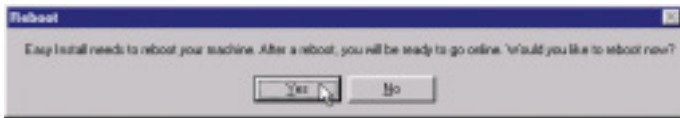

5.5 When your computer reboots, your computer will be connected to the network. To begin surfing the Internet, open your browser and go to your favorite web page.

You are finished adding the computer to the network. To add more computers, repeat this process on each computer you wish to add.

## ALTERNATE SETUP METHOD

The Advanced User Interface is a web-based tool that you can use to set up the Router if you don't want to use the Easy Install Wizard. You can also use it to manage advanced functions of the Router. From the Advanced User Interface, you can perform the following tasks:

- View the Router's current settings and status.
- Configure the Router to connect to your ISP with the settings that they provided you.
- Change the current network settings such as the Internal IP address, the IP address pool, DHCP settings and more.
- Set the Router's firewall to work with specific applications (port forwarding).
- Set up security features such as client restrictions and MAC address filtering.
- Enable the DMZ feature for a single computer on your network.
- Change the Router's internal password.
- Enable/Disable UPnP (Universal Plug-and-Play).
- Reset the Router.
- Back up your configuration settings.
- Reset the Router's default settings.
- Update the Router's firmware.

### **Alternative Method Step 1:**

#### **Connecting your Gateway Router**

- 1.1** Turn off the power to your modem by unplugging the power supply from the modem.
- 1.2** Locate the network cable that is connected between your modem and your computer and unplug it from your computer, leaving the other end connected to your modem.
- 1.3** Plug the loose end of the cable you just unplugged into the port on the back of the Router labeled "Internet/WAN".

## ALTERNATE SETUP METHOD

- 1.4 Connect a new network cable (not included) from the back of the computer to one of the ports labeled “1–4”. *Note: It does not matter which numbered port you choose.*
- 1.5 Turn your cable or DSL modem on by reconnecting the power supply to the modem.

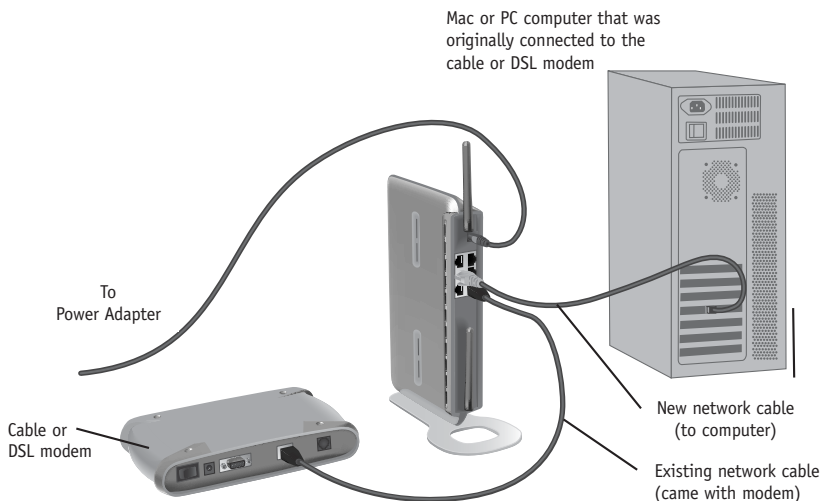

- 1.6 Before plugging the power cord into the Router, plug the cord into the wall, then plug the cord into the Router’s power jack.
- 1.7 Verify that your modem is connected to the Router by checking the lights on the front of the Router. The green light labeled “WAN” should be ON if your modem is connected correctly to the Router. If it is not, recheck your connections.
- 1.8 Verify that your computer is connected properly to the Router by checking the lights labeled “LAN 1,2,3,4”. The light which corresponds to the numbered port connected to your computer should be ON, if your computer is connected properly. If it is not, recheck your connections.

## ALTERNATE SETUP METHOD

### Alternative Method Step 2:

#### Set your Computer's Network Settings to Work with a DHCP Server

See the section in this manual called "Manually Configuring Network Settings" for directions.

### Alternative Method Step 3:

#### Configuring the Router Using the Web-Based Advanced User Interface

Using your Internet browser, you can access the Router's Web-Based Advanced User Interface. In your browser, type "192.168.2.1" (do not type in anything else such as "http://" or "www"). Then press the "Enter" key.

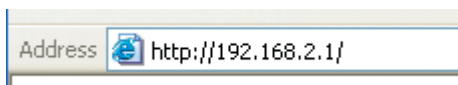

#### Logging into the Router

You will see the Router's home page in your browser window. The home page is visible to any user who wants to see it. To make any changes to the Router's settings, you have to log in. Clicking the "Login" button or clicking on any one of the links on the home page will take you to the login screen. The Router ships with no password entered. In the login screen, leave the password blank and click the "Submit" button to log in.



# ALTERNATE SETUP METHOD

## Logging out of the Router

One computer at a time can log in to the Router for the purposes of making changes to the settings of the Router. Once a user has logged in to make changes, there are two ways that the computer can be logged out. Clicking the “Logout” button will log the computer out. The second method is automatic. The login will time out after a specified period of time. The default login time out is 10 minutes. This can be changed from 1 to 99 minutes. For more information, see the section in this manual titled “Changing the Login Timeout Setting”.

## Understanding the Web-Based Advanced User Interface

The home page is the first page you will see when you access the Advanced User Interface (UI). The home page shows you a quick view of the Router’s status and settings. All advanced setup pages can be reached from this page.

The screenshot shows the Belkin Cable/DSL Gateway Router Setup Utility home page. The interface includes a top navigation bar with links for Home, Help, Logout, and Internet Status. A left sidebar contains a menu of setup categories. The main content area displays the 'Status' page, which is divided into four sections: Version Info, LAN Settings, Wireless Settings, and Features. Numbered callouts (1) through (10) identify specific UI elements:

- (1) Points to the left sidebar menu.
- (2) Points to the Home link in the top navigation bar.
- (3) Points to the Internet Status link in the top navigation bar.
- (4) Points to the Logout link in the top navigation bar.
- (5) Points to the Help link in the top navigation bar.
- (6) Points to the LAN Settings section in the Status page.
- (7) Points to the Features section in the Status page.
- (8) Points to the Wireless Settings section in the Status page.
- (9) Points to the Version Info section in the Status page.
- (10) Points to the Status page title.

Version Info	LAN Settings
Firmware Version: 1.01.05	LAN/WLAN MAC: 08-00-80-8F-AD-D8-7
Boot Version: 1.03.07	08-00-80-8F-DC-C4
Hardware: TSD7236-A	IP address: 192.168.2.1
Serial No.: BEL00W1	Subnet mask: 255.255.255.0
	DHCP Server: Enabled

Wireless Settings	Features
Wireless address: 30-30-80-0F-AD-C8	NAT: Enable
Connection Type: PPPoE	Firewall Settings: Enable
Subnet mask: 255.255.255.255	SNOS: Disabled
Wan IP: 66.125.214.13	Encryption: Disable
Default gateway: 66.125.215.254	
DNS Address: 206.13.29.12	

## ALTERNATE SETUP METHOD

### 1. Quick-Navigation Links

You can go directly to any of the Router's advanced UI pages by clicking directly on these links. The links are divided into logical categories and grouped by tabs to make finding a particular setting easier to find. Clicking on the purple header of each tab will show you a short description of the tab's function.

### 2. Home Button

The home button is available in every page of the UI. Pressing this button will take you back to the home page.

### 3. Internet Status Indicator

This indicator is visible in all pages of the Router, indicating the connection status of the Router. When the indicator says "connection OK" in GREEN, the Router is connected to the Internet. When the Router is not connected to the Internet, the indicator will read "no connection" in RED. The indicator is automatically updated when you make changes to the settings of the Router.

### 4. Login/Logout Button

This button enables you to log in and out of the Router with the press of one button. When you are logged into the Router, this button will change to read "Logout". Logging into the Router will take you to a separate login page where you will need to enter a password. When you are logged in to the Router, you can make changes to the settings. When you are finished making changes, you can log out of the Router by clicking the "Logout" button. For more information about logging into the Router, see the section called "Logging into the Router".

### 5. Help Button

The "Help" button gives you access to the Router's help pages. Help is also available on many pages by clicking "more info" next to certain sections of each page.

## ALTERNATE SETUP METHOD

### 6. LAN Settings

Shows you the settings of the Local Area Network (LAN) side of the Router. Changes can be made to the settings by clicking on any one of the links (IP Address, Subnet Mask, DHCP Server) or by clicking the “LAN” Quick Navigation link on the left side of the screen.

### 7. Features

Shows the status of the Router’s NAT, firewall, and wireless features. Changes can be made to the settings by clicking on any one of the links or by clicking the “Quick Navigation” links on the left side of the screen.

### 8. Internet Settings

Shows the settings of the Internet/WAN side of the Router that connects to the Internet. Changes to any of these settings can be made by clicking on the links or by clicking on the “Internet/WAN” Quick Navigation link on the left side of the screen.

### 9. Version Info

Shows the firmware version, boot-code version, hardware version, and serial number of the Router.

### 10. Page Name

The page you are on can be identified by this name. This manual will sometimes refer to pages by name. For instance “LAN > LAN Settings” refers to the “LAN Settings” page.

# ALTERNATE SETUP METHOD

## Alternative Method Step 4:

### Configuring your Router for Connection to your ISP

The “Internet/WAN” tab is where you will set up your Router to connect to your Internet Service Provider. The Router is capable of connecting to virtually any Internet Service Provider’s system provided you have correctly configured the Router’s settings for your ISP’s connection type. Your ISP connection settings are provided to you by your ISP. To configure the Router with the settings that your ISP gave you, click “Connection Type” **(A)** on the left side of the screen. Select the connection type you use. If your ISP gave you DNS settings, clicking “DNS” **(B)** allows you to enter DNS address entries for ISPs that require specific settings. Clicking “MAC address” **(C)** will let you clone your computer’s MAC address or type in a specific WAN MAC address, if required by your ISP. When you have finished making settings, the “Internet Status” indicator will read “connection OK” if your Router is set up properly.

The screenshot shows the Mikrotik WinBox interface for configuring the WAN settings. The left sidebar contains a navigation menu with the following items: LAN Settings, DHCP Shared List, Advanced DHCP, **Connection Type** (A), DNS (B), MAC ADDRESS (C), IP Address, Channel and IPsec, Bridge, Size of Access Point, Wireless Bridge, Firewall, Virtual Servers, DHCP IP Ranges, MAC Address Filtering, DNS, PPPoE, Security, and Settings. The main content area is titled "WAN" and contains the following text: "The Internet/WAN Tab is where you will set up your Router to connect to your Internet Service Provider. The Router is capable of connecting to virtually any Internet Service Provider's system provided that you have correctly configured the Router's settings for your ISP's connection type. To configure the Router to connect to your ISP, click on 'Connection Type' on the Internet/WAN Tab on the left of the screen." Below this text, there is a section titled "Connection Types supported:" with a bulleted list: "Dynamic: including ISPs that require a host name and ISPs that bind the connection to a specific MAC address.", "Static IP address: the Router supports a connection to an ISP which assign a static IP address.", "PPPoE: the Router supports a dynamic connection type which requires a PPPoE login for authentication.", "PPTP: For European users ONLY. The Router supports connections to European ISPs which connect via PPTP.", and "Telstra Bigpond: Australian users ONLY. The router supports connection to Telstra Bigpond."



# ALTERNATE SETUP METHOD

## Setting your Connection Type

From the connection type page, you can select the type of connection you use. Select the type of connection you use by clicking the radio button **(1)** next to your connection type and then clicking “Next” **(2)**.

The screenshot shows the BELKIN CoMo/DSL Gateway Setup Utility interface. On the left is a navigation menu with options like LAN Setup, DHCP Client List, Connection Type (highlighted), DNS, MAC Address, Port Setup, Firewall, and Utilities. The main content area is titled 'WAN > Connection Type' and contains the instruction 'Select your connection type:'. There are five radio button options: **Dynamic** (selected), **Static**, **PPPoE**, **PPPoE**, and **Telstra Big Pond**. Each option has a brief description. At the bottom right, there is a 'Next >' button.

## ALTERNATE SETUP METHOD

### Setting your ISP Connection Type to Dynamic IP

A dynamic connection type is the most common connection type found with cable modems. Setting the connection type to “dynamic” in many cases is enough to complete the connection to your ISP. Some dynamic connection types may require a host name. You can enter your host name in the space provided if you were assigned one. Your host name is assigned by your ISP. Some dynamic connections may require that you clone the MAC address of the PC that was originally connected to the modem.



#### 1. Host Name

This space is provided to enter a host name that needs to be visible to your ISP. Enter your host name here and click “Apply Changes” (3). If your ISP did not assign you a host name, or you are not sure, leave this blank.

#### 2. Change WAN MAC Address

If your ISP requires a specific MAC address to connect to the service, you can enter a specific MAC address or clone the current computer’s MAC address through this link.

## ALTERNATE SETUP METHOD

### Setting your ISP Connection Type to Static IP

A static IP address connection type is less common than other connection types. If your ISP uses static IP addressing, you will need your IP address, subnet mask, and ISP gateway address. This information is available from your ISP or on the paperwork that your ISP left with you. Type in your information, then click “Apply Changes” (5). After you apply the changes, the Internet Status indicator will read “connection OK” if your Router is set up properly.

The screenshot shows the Belkin Gateway Router Setup Utility interface. The title bar reads "BELKIN Gateway Router Setup Utility" and "Home | Help | Logout | Internet Status". The left sidebar contains a menu with options: LAN Setup, LAN Settings, DHCP Client List, **Advanced Setup**, Connection Type, DNS, WAN Address, LAN Address, Channel and SSID, Connections, Use as Access Point, Wireless Bridge, Firewall, Virtual Servers, Client IP Filters, WAN Address Filtering, DMZ, Host Ping Blocking, Security Log, **Utilities**, Parental Control, and Packet Router. The main content area is titled "WAN > Connection Type > Static IP" and contains the following text: "To enter your Static IP settings, type in your information below and click 'Apply changes'." Below this are three input fields: "IP Address >" (with four empty boxes), "Subnet Mask >" (with four empty boxes), and "ISP Gateway Address >" (with four empty boxes). There is a checkbox labeled "My ISP Provides more than one Static IP address? >". Below the checkbox is a link: "Click here to enter your DNS settings". At the bottom are two buttons: "Clear Changes" and "Apply Changes" (labeled with a circled 5).

#### 1. IP Address

Provided by your ISP. Enter your IP address here.

#### 2. Subnet Mask

Provided by your ISP. Enter your subnet mask here.

#### 3. ISP Gateway Address

Provided by your ISP. Enter the ISP gateway address here.

#### 4. My ISP Provides More Than One Static IP Address

If your ISP assigns you more than one static IP address, your Router is capable of handling up to five static WAN IP addresses. Select “My ISP provides more than one static IP address” and enter your additional addresses.

## ALTERNATE SETUP METHOD

### Setting your ISP Connection Type to Point-to-Point Tunneling Protocol (PPTP) [European Countries Only].

Some ISPs require a connection using PPTP protocol, a type of connection most common in European countries. This sets up a direct connection to the ISP's system. Type in the information provided by your ISP in the space provided. When you have finished, click "Apply Changes" **(9)**. After you apply the changes, the Internet Status indicator will read "connection OK" if your Router is set up properly.

1. LAN Setup  
2. DHCP Client List  
3. Connection Type  
4. WAN Settings  
5. PPTP Account >  
6. PPTP Password >  
7. Retype Password >  
8. Host Name >  
9. Apply Changes

#### 1. PPTP Account

Provided by your ISP. Enter your PPTP account name here.

#### 2. PPTP Password

Type in your password and retype it into the "Retype Password" box to confirm it.

#### 3. Host Name

Provided by your ISP. Enter your host name here.

## ALTERNATE SETUP METHOD

### **4. Service IP Address**

Provided by your ISP. Enter your service IP address here.

### **5. My IP Address**

Provided by your ISP. Enter the IP address here.

### **6. My Subnet Mask**

Provided by your ISP. Enter the IP address here.

### **7. Connection ID (optional)**

Provided by your ISP. If your ISP did not give you a connection ID, leave this blank.

### **8. Disconnect after X....**

The Disconnect feature is used to automatically disconnect the Router from your ISP when there is no activity for a specified period of time. For instance, placing a check mark next to this option and entering "5" into the minute field will cause the Router to disconnect from the Internet after five minutes of no Internet activity. This option should be used if you pay for your Internet service by the minute.

## ALTERNATE SETUP METHOD

### Setting your Connection Type if you are a Telstra® BigPond User

[Australia Only] Your user name and password are provided to you by Telstra BigPond. Enter this information below. Choosing your state from the drop-down menu **(6)** will automatically fill in your login server IP address. If your login server address is different than one provided here, you may manually enter the login server IP address by placing a check in the box next to “User decide login server manually” **(4)** and type in the address next to “Login Server” **(5)**. When you have entered all of your information, click “Apply Changes” **(7)**. After you apply the changes, the Internet Status indicator will read “connection OK” if your Router is set up properly.



#### 1. Select your State

Select your state from the drop-down menu **(6)**. The “Login Server” box will automatically be filled in with an IP address. If for some reason this address does not match the address that Telstra has given you, you can manually enter the login server address. See “User Decide Login Server Manually” **(4)**.

#### 2. User Name

Provided by your ISP. Type in your user name here.

## ALTERNATE SETUP METHOD

### 3. Password

Type in your password and retype it into the “Retype Password” box to confirm it.

### 4. User Decide Login Server Manually

If your login server IP address is not available in the “Select Your State” drop-down menu (6), you may manually enter the login server IP address by placing a check in the box next to “User decide login server manually” and type in the address next to “Login Server” (5).

### Setting Custom Domain Name Server (DNS) Settings

A “Domain Name Server” is a server located on the Internet that translates Universal Resource Links (URLs) like “www.belkin.com” to IP addresses. Many ISPs do not require you to enter this information into the Router. The “Automatic from ISP” box (1) should be checked if your ISP did not give you a specific DNS address. If you are using a static IP connection type, then you may need to enter a specific DNS address and secondary DNS address for your connection to work properly. If your connection type is dynamic or PPPoE, it is likely that you do not have to enter a DNS address. Leave the “Automatic from ISP” box checked. To enter the DNS address settings, uncheck the “Automatic from ISP” box and enter your DNS entries in the spaces provided. Click “Apply Changes” (2) to save the settings.

The screenshot shows the Belkin Cable/DSL Gateway Router Setup Utility interface. On the left is a navigation menu with options: LAN Setup, LAN Settings, DHCP Client List, Network Utility, Connection type, WAN, MAC Address, Wireless, Channel and SSID, Encryption, Use as Access Point, Wireless Bridge, Firewall, Virtual Servers, and Client IP Filters. The 'WAN' option is highlighted. The main content area is titled 'WAN > DNS'. It contains the following text: 'If your ISP provided you with a specific DNS address to use, enter the address in this window and click "Apply Changes".' Below this is a checked checkbox labeled 'Automatic from ISP'. There are two rows of input fields for 'DNS Address >' and 'Secondary DNS Address >', each with four boxes. At the bottom are two buttons: 'Clear Changes' and 'Apply Changes'. A callout (1) points to the 'Automatic from ISP' checkbox, and a callout (2) points to the 'Apply Changes' button.

## ALTERNATE SETUP METHOD

### **Configuring your WAN Media Access Controller (MAC) Address**

All network components including cards, adapters, and routers, have a unique “serial number” called a MAC address. Your ISP may record the MAC address of your computer’s adapter and only let that particular computer connect to the Internet service. When you install the Router, its own MAC address will be “seen” by the ISP and may cause the connection not to work. Belkin has provided the ability to clone (copy) the MAC address of the computer into the Router. This MAC address, in turn, will be seen by the ISP’s system as the original MAC address and will allow the connection to work. If you are not sure whether your ISP needs to see the original MAC address, simply clone the MAC address of the computer that was originally connected to the modem. Cloning the address will not cause any problems with your network.



## ALTERNATE SETUP METHOD

### Cloning your MAC Address

To clone your MAC address, make sure that you are using the computer that was **ORIGINALLY CONNECTED** to your modem before the Router was installed. Click the “Clone” button **(1)**. Click “Apply Changes” **(2)**. Your MAC address is now cloned to the Router.

### Entering a Specific MAC Address

In certain circumstances you may need a specific WAN MAC address. You can manually enter one in the “MAC Address” page. Type in a MAC address in the spaces provided **(3)** and click “Apply Changes” to save the changes. The Router’s WAN MAC address will now be changed to the MAC address you specified.

The screenshot shows the Belkin router's configuration utility. The main content area is titled "WAN > DNS". It contains the following text: "Some ISPs require that you clone (copy) the MAC address of your computer's network card into the Router. If you are not sure then simply clone the MAC address of the computer that was originally connected to the modem before installing the Router. Cloning your MAC address will not cause any problems with your network. Here help". Below this text, there is a "WAN Mac Address >" label followed by a text input field containing the MAC address "08 30 BD 8F AD D9". To the right of this field is callout (3). Below the input field is a "Clone Computer's MAC Address >" button with a "Clone" label, which is pointed to by callout (1). At the bottom of the main content area are two buttons: "Clear Changes" and "Apply Changes", with callout (2) pointing to the "Apply Changes" button. On the left side, there is a sidebar menu with categories: "LAN Setup", "Internet WAN", "Firewall", and "Utilities". The "Internet WAN" category is expanded, showing sub-items like "Connection Type", "DNS", "MAC Address", "Wireless", "Channel and SSID", "Encryption", "Wireless Access Point", "Wireless Bridge", "Virtual Servers", "DMZ IP Address", "MAC Address Filtering", "SNAT", "WAN Ping Blocking", "Security Log", "Utilities", "Parental Control", "Router's Router", "Router's Factory Default", "Save/Backup Settings", "Restore Previous Settings", "Firmware Update", and "System Settings".

# USING THE WEB-BASED ADVANCED USER INTERFACE

Using your Internet browser, you can access the Router's Web-Based Advanced User Interface. In your browser, type "192.168.2.1" (do not type in anything else such as "http://" or "www") then press the "Enter" key.

You will see the Router's home page in your browser window.

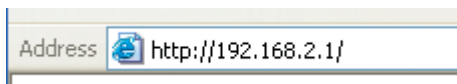

## Viewing the LAN Settings

Clicking on the header of the LAN tab **(1)** will take you to the LAN tab's header page. A quick description of the functions can be found here. To view the settings or make changes to any of the LAN settings, click on "LAN Settings" **(2)** or to view the list of connected computers, click on "DHCP client list" **(3)**.

**BELKIN** ConfigDSL Gateway Router Setup Utility

Home | Help | Logout | Internet Status: Connected

**(1)** LAN Settings  
**(2)** LAN Settings  
**(3)** DHCP Client List

**LAN >**

Your Router is equipped with a DHCP server that will automatically assign IP addresses to each computer on your network. The factory default settings for the DHCP server will work in most any application. If you need to make changes to the settings, you can do so.

The changes that you can make are:

- Change the Internet IP address of the Router. The default = 192.168.2.1
- Change the Subnet Mask. The default = 255.255.255.0
- Enable/Disable the DHCP Server Function. Default = ON (Enabled)
- Specify the Starting and Ending IP Pool Address. Default = Starting: 2 / Ending: 100
- Specify the IP address Lease Time. Default = Forever
- Specify a local Domain Name. Default = NONE

To make changes, click "LAN Settings" in the LAN tab to the left.

The Router will also provide you with a list of all client computers connected to the network. To view the list, click "DHCP client list" on the LAN tab to the left.

**Menu:**

- LAN Settings
- DHCP Client List
- Internet Wizard
- Connection Type
- DNS
- MAC Address
- Wireless
- Channel and SSID
- Bridge/Port
- Use as Access Point
- Wireless Bridge
- Firewall
- Web Servers
- Client IP Filter
- MAC Address Filtering
- DAD
- WAN Ping Bouncing
- Security Log
- Utilities
- Parental Control
- Restart Router
- Restore Factory Default
- Save/Backup Settings
- Restore Previous Settings
- Firmware Update
- System Settings

# USING THE WEB-BASED ADVANCED USER INTERFACE

## Changing LAN Settings

All settings for the internal LAN setup of the Router can be viewed and changed here.



### 1. IP Address

The “IP address” is the internal IP address of the Router. The default IP address is “192.168.2.1”. To access the advanced setup interface, type this IP address into the address bar of your browser. This address can be changed if needed. To change the IP address, type in the new IP address and click “Apply Changes”. The IP address you choose should be a non-routable IP. Examples of a non-routable IP are:

192.168.x.x (where x is anything between 0 and 255)

10.x.x.x (where x is anything between 0 and 255)

### 2. Subnet Mask

There is no need to change the subnet mask. This is a unique, advanced feature of your Belkin Router. It is possible to change the subnet mask if necessary, however, do NOT make changes to the subnet mask unless you have a specific reason to do so. The default setting is “255.255.255.0”.

## USING THE WEB-BASED ADVANCED USER INTERFACE

### 3. DHCP Server

The DHCP server function makes setting up a network very easy by assigning IP addresses to each computer on the network automatically. The default setting is “On”. The DHCP server can be turned OFF if necessary, however, in order to do so you must manually set a static IP address for each computer on your network. To turn off the DHCP server, select “Off” and click “Apply Changes”.

### 4. IP Pool

The range of IP addresses set aside for dynamic assignment to the computers on your network. The default is 2–100 (99 computers). If you want to change this number, you can do so by entering a new starting and ending IP address and clicking on “Apply Changes”. The DHCP server can assign 100 IP addresses automatically. This means that you cannot specify an IP address pool larger than 100 computers. For example, starting at 50 means you have to end at 150 or lower so as not to exceed the 100-client limit. The starting IP address must be lower in number than the ending IP address.

### 5. Lease Time

The length of time the DHCP server will reserve the IP address for each computer. We recommend that you leave the lease time set to “Forever”. The default setting is “Forever”, meaning that any time a computer is assigned an IP address by the DHCP server, the IP address will not change for that particular computer. Setting lease times for shorter intervals such as one day or one hour frees IP addresses after the specified period of time. This also means that a particular computer’s IP address may change over time. If you have set any of the other advanced features of the Router such as DMZ or client IP filters, these are dependent on the IP address. For this reason, you will not want the IP address to change.

### 6. Local Domain Name

The default setting is “Belkin”. You can set a local domain name (network name) for your network. There is no need to change this setting unless you have a specific advanced need to do so. You can name the network anything you want such as “MY NETWORK”.

## USING THE WEB-BASED ADVANCED USER INTERFACE

### Viewing the DHCP Client List Page

You can view a list of the computers (known as clients), which are connected to your network. You are able to view the IP address **(1)** of the computer, the host name **(2)** (if the computer has been assigned one), and the MAC address **(3)** of the computer's network interface card (NIC). Pressing the "Refresh" **(4)** button will update the list. If there have been any changes, the list will be updated.

LAN > DHCP Client List

This page shows you the IP address, Host Name and MAC address of each computer that is connected to your network. If the computer does not have a host name specified, then the Host Name field will be blank. Pressing "Refresh" will update the list.  
[/admin/console: list such device](#)

IP Address	Host Name	MAC Address
192.168.2.2	xp-test	30:10:b5:0c:b7:19
192.168.2.77	employee-01906a	30:50:da:62:11e8

Refresh

## USING THE WEB-BASED ADVANCED USER INTERFACE

### Configuring the Wireless Network Settings

The Wireless tab lets you make changes to the wireless network settings. From this tab you can make changes to the wireless network name (SSID), operating channel, encryption security settings, and configure the Router to be used as an access point.

### Changing the Wireless Network Name (SSID)

To identify your wireless network, a name called the SSID (Service Set Identifier) is used. The default SSID of the Router is “belkin54g”. You can change this to anything you want to or you can leave it unchanged. If there are other wireless networks operating in your area, you will want to make sure that your SSID is unique (does not match that of another wireless network in the area). To change the SSID, type in the SSID that you want to use in the SSID field **(1)** and click “Apply Changes” **(2)**. The change is immediate. If you make a change to the SSID, your wireless-equipped computers may also need to be reconfigured to connect to your new network name. Refer to the documentation of your wireless network adapter for information on making this change.



## USING THE WEB-BASED ADVANCED USER INTERFACE

### Using the Wireless Mode Switch

Your Router can operate in three different wireless modes: “54g-Auto”, “54g-Only”, and “54g-LRS”. The different modes are explained below.

#### 54g-Auto Mode

In this mode, the Router is compatible with 802.11b and 54g wireless clients simultaneously. This is the factory default mode and ensures successful operation with all Wi-Fi-compatible devices. If you have a mix of 802.11b and 54g clients in your network, we recommend setting the Router to 54g-Auto mode. This setting should only be changed if you have a specific reason to do so.

#### 54g-Only Mode

54g-Only mode works with 54g clients only. This mode is recommended only if you want to prevent 802.11b clients from accessing your network. To switch modes, select the desired mode from the “Wireless Mode” drop-down box. Then, click “Apply Changes”.

#### 54g-LRS Mode

We recommend you DO NOT use this mode unless you have a very specific reason to do so. This mode exists only to solve unique problems that may occur with some 802.11b client adapters and is NOT necessary for interoperability of 54g and 802.11b standards.

#### When to use 54g-LRS Mode

In some cases, older 802.11b clients may not be compatible with 54g wireless. These adapters tend to be of inferior design and may use older drivers or technology. 54g-LRS (Limited Rate Support) allows these clients to be compatible with the newer 54g technology. Switching to this mode can solve problems that sometimes occur with these clients. If you suspect that you are using a client adapter that falls into this category of adapters, first check with the adapter vendor to see if there is a driver update. If there is no driver update available, switching to 54g-LRS mode may fix your problem. ***Please note that switching to 54g-LRS mode may decrease 54g performance slightly.***

## USING THE WEB-BASED ADVANCED USER INTERFACE

### Turbo Mode

Turbo mode is enabled by default. It allows the Router or Access Point to use frame bursting to deliver the maximum throughput, 2 times faster than any standard 802.11g equipment, to 802.11g clients. This measurement is based on aggregate throughput in a mixed 802.11b and 802.11g environment. Belkin 802.11g clients with the latest driver will support Turbo mode. Clients that do not support Turbo mode will operate normally with it enabled. To switch Turbo mode off, select "OFF" (1) from the drop-down menu and click "Apply Changes".

Wireless > Channel and SSID

To make changes to the wireless settings of the router, make the changes here. Click "Apply Changes" to save the settings. Please Save.

Wireless Channel > 11

SSID > belkin54g

Wireless Mode > 54G+Auto

Broadcast SSID >  Here Info

Turbo Mode > Off (1)

Protected Mode > Off

NOTE: In most situations, best performance (throughput) is achieved with Protected Mode Off. If you are operating in an environment with HEAVY 802.11b traffic or interference, best performance may be achieved with Protected Mode On.

Clear Changes Apply Changes



## USING THE WEB-BASED ADVANCED USER INTERFACE

### Changing the Wireless Channel

There are a number of operating channels you can choose from. In the United States, there are 11 channels. In the United Kingdom and most of Europe, there are 13 channels. In a small number of other countries, there are other channel requirements. Your Router is configured to operate on the proper channels for the country you reside in. The default channel is 11. (unless you are in a country that does not allow channel 11). The channel can be changed if needed. If there are other wireless networks operating in your area, your network should be set to operate on a channel that is different than the other wireless networks. For best performance, use a channel that is at least five channels away from the other wireless network. For instance, if another network is operating on channel 11, then set your network to channel 6 or below. To change the channel, select the channel from the drop-down list. Click "Apply Changes". The change is immediate.

#### Wireless > Channel and SSID

To make changes to the wireless settings of the router, make the changes here. Click "Apply Changes" to save the settings. [More Info](#)

Wireless Channel >

SSID >

Wireless Mode >

Broadcast SSID >

Protected Mode >

11

1

2

3

4

5

6

7

8

9

10

11

NOTE: In most situations, best performance (throughput) is achieved with Protected Mode OFF. If you are operating in an environment with HEAVY 802.11b traffic or interference, best performance may be achieved with Protected Mode ON.

Clear Changes

Apply Changes

## USING THE WEB-BASED ADVANCED USER INTERFACE

### Using the Broadcast SSID Feature

*Note: This advanced feature should be employed by advanced users only.*

For security, you can choose not to broadcast your network's SSID. Doing so will keep your network name hidden from computers that are scanning for the presence of wireless networks. To turn off the broadcast of the SSID, remove the check mark from the box next to "Broadcast SSID", and then click "Apply Changes". The change is immediate. Each computer now needs to be set to connect to your specific SSID; an SSID of "ANY" will no longer be accepted. Refer to the documentation of your wireless network adapter for information on making this change.

### Protected Mode Switch

As part of the 802.11g specification, Protected mode ensures proper operation of 802.11g clients and access points when there is heavy 802.11b traffic in the operating environment. When protected mode is ON, 802.11g scans for other wireless network traffic before it transmits data. Therefore, using this mode in environments with HEAVY 802.11b traffic or interference achieves best performance results. If you are in an environment with very little—or no—other wireless network traffic, your best performance will be achieved with Protected mode OFF.

#### Wireless > Channel and SSID

To make changes to the wireless settings of the router, make the changes here. Click "Apply Changes" to save the settings. [More Info](#)

Wireless Channel >

11

SSID >

bobin54g

Wireless Mode >

54GAuto

Broadcast SSID >

[More Info](#)

Protected Mode >

Off  
On

NOTE: In most situations, best performance (throughput) is achieved with Protected Mode OFF. If you are operating in an environment with HEAVY 802.11b traffic or interference, best performance may be achieved with Protected Mode ON.

Clear Changes

Apply Changes

### Changing the Wireless Security Settings

Your Router is equipped with WPA (Wireless Protected Access), the latest security standard . It also supports the legacy security standard, WEP (Wired Equivalent Privacy). By default, wireless security is disabled. To enable security, you must first determine which standard you want to use. To access the security settings, click “Security” on the Wireless tab.

#### Setting WPA Security

*Note: To use WPA security, all your clients must be upgraded to drivers and software that support it. At the time of this manual's publication, a security patch download is available, for free, from Microsoft. This patch works only with the Windows XP operating system. You also need to download the latest driver for your Belkin 54g Wireless PCI or CardBus card from the Belkin support site. Other operating systems are not supported at this time. Microsoft's patch only supports devices with WPA-enabled drivers such as Belkin 54g products.*

There are two types of WPA security: WPA-PSK (no server) and WPA (with server). WPA-PSK uses a so-called pre-shared key as the security key. A pre-shared key is a password that is between eight and 40 characters long. It can be a combination of letters, numbers, and other characters. Each client uses the same key to access the network. Typically, this mode will be used in a home environment.

WPA (with server) is a configuration wherein a radius server distributes the keys to the clients automatically. This is typically used in a business environment.

#### Setting WPA-PSK (no server)

1. From the “Security Mode” drop-down menu, select “WPA-PSK (no server)”.
2. For Encryption Technique, select “TKIP” or “AES”. This setting will have to be identical on the clients that you set up.
3. Enter your pre-shared key. This can be from eight to 40 characters and can be letters, numbers, or symbols. This same key must be used on all of the clients that you set up. For example, your PSK might be something like: “Smith family network key”.

## USING THE WEB-BASED ADVANCED USER INTERFACE

- Click “Apply Changes” to finish. You must now set all clients to match these settings.



The screenshot shows the 'Wireless > Security' configuration page. The 'Security Mode' is set to 'WPA-PSK (HOME) (no server)'. The 'Encryption Technique' is set to 'TKIP'. The 'Pre-shared Key (PSK)' field contains a masked key (represented by asterisks). Below the PSK field, a note states: 'PSK can be a word or phrase up to 48 digits'. At the bottom of the form are two buttons: 'Clear Changes' and 'Apply Changes'.

### Setting WPA (with server) Settings

If your network uses a radius server to distribute keys to the clients, use this setting.

- From the “Security Mode” drop-down menu, select “WPA (with server)”.
- For Encryption Technique, select “TKIP” or “AES”. This setting will have to be identical on the clients that you set up.
- Enter the IP address of the radius server into the “Radius Server” fields
- Enter the radius key into the “Radius Key” field.
- Enter the key interval. Key interval is how often the keys are distributed (in packets).
- Click “Apply Changes” to finish. You must now set all clients to match these settings.



The screenshot shows the 'Wireless > Security' configuration page. The 'Security Mode' is set to 'WPA-RADIUS Server'. The 'Encryption Technique' is set to 'TKIP'. The 'Radius Server' field is split into four input boxes. The 'Radius Port' is set to '1812'. The 'Radius Key' field is empty. The 'Key Interval' is set to '15'. At the bottom of the form are two buttons: 'Clear Changes' and 'Apply Changes'.

## USING THE WEB-BASED ADVANCED USER INTERFACE

### Setting WEP Encryption

**Note to Mac users:** The Passphrase option will not operate with Apple® AirPort®. To configure encryption for your Mac computer, set the encryption using the manual method described in the next section.

1. Select “128-bit WP” or “64-bit WEP” from the drop-down menu.

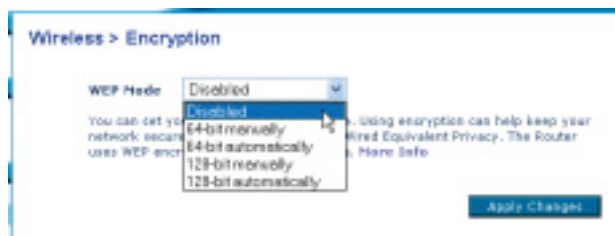

2. After selecting your WEP encryption mode, you can type in your HEX WEP key manually, or you can type in a passphrase in the “Passphrase” field and click “Generate” to create a WEP key from the passphrase. Click “Apply Changes” to finish. You must now set all of your clients to match these settings.



3. Encryption in the Router is now set. Each of your computers on your wireless network will now need to be configured with the same passphrase. Refer to the documentation of your wireless network adapter for information on making this change.

## USING THE WEB-BASED ADVANCED USER INTERFACE

### Using a Hexadecimal Key

A hexadecimal key is a mixture of numbers and letters from A–F and 0–9. 64-bit keys are five two-digit numbers. 128-bit keys are 13 two-digit numbers.

For instance:

**AF OF 4B C3 D4** = 64-bit key

**C3 03 OF AF OF 4B B2 C3 D4 4B C3 D4 E7** = 128-bit key

In the boxes below, make up your key by writing in two characters between A–F and 0–9. You will use this key to program the encryption settings on your Router and your wireless computers.

Example:

64-bit:

128-bit:

**Note to Mac users:** Original Apple AirPort products support 64-bit encryption only. Apple AirPort 2 products can support 64-bit or 128-bit encryption. Please check your product to see which version you are using. If you cannot configure your network with 128-bit encryption, try 64-bit encryption.

### Using the Access Point Mode

**Note:** *This advanced feature should be employed by advanced users only.* The Router can be configured to work as a wireless network access point. Using this mode will defeat the NAT IP sharing feature and DHCP server. In AP mode, the Router will need to be configured with an IP address that is in the same subnet as the rest of the network that you will bridge to. The default IP address is 192.168.2.254 and subnet mask is 255.255.255.0. These can be customized for your need.

1. Enable the AP mode by selecting “Enable” in the “Use as Access Point only” page. When you select this option, you will be able to change the IP settings.
2. Set your IP settings to match your network. Click “Apply Changes”.
3. Connect a cable from the WAN port on the Router to your existing network.

The Router is now acting as an Access Point. To access the Router advanced user interface again, type the IP address you specified into your browser’s navigation bar. You can set the encryption settings, MAC address filtering, SSID and channel normally.

## USING THE WEB-BASED ADVANCED USER INTERFACE

### Wireless Bridging

Wireless bridging works with the following models only:

F5D7230-4 54g Wireless Cable/DSL Gateway Router

F5D7130 54g Wireless Network Access Point

The following firmware version must be installed on the Access Point and the Router for proper operation:

F5D7230-4: Version 1.01.08 or higher

F5D7130: Version 1.01.08 or higher

### What is a Wireless Bridge?

A wireless bridge is actually a “mode” in which your Wireless Router can directly connect to a secondary Wireless Access Point. Note that you can only bridge your 54g Wireless Router (Model F5D7230-4) to a Belkin 54g Wireless Access Point (model F5D7130). Bridging with Access Points of other manufacturers is not supported at this time. You can use the bridge mode to extend the range of your wireless network, or add an extension of your network in another area of your office or home without running cables.

### Range Extension

Range extension will extend the wireless coverage area in your home or office. The example on the next page illustrates use of bridging to extend the range of your wireless network. In this example, the Router is set up to connect to an Access Point located in another area. Laptops can roam, or move between the two wireless coverage areas.



## USING THE WEB-BASED ADVANCED USER INTERFACE

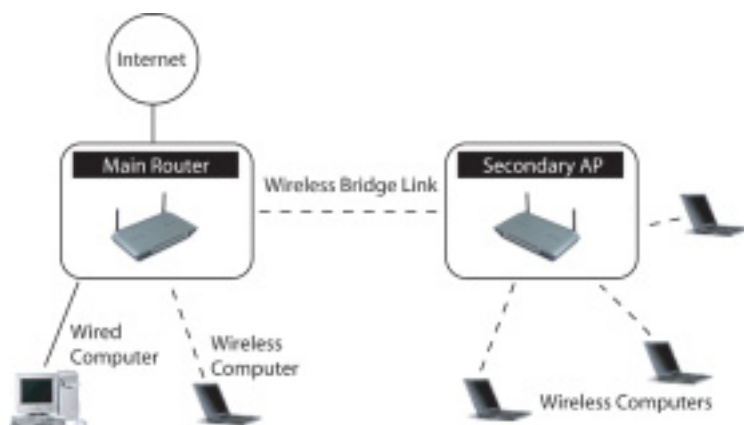

### Adding Another Network Segment Wirelessly

Bridging an Access Point to your Wireless Router allows you to add another network segment in another area in the home or office without running wires. Connecting a network switch or hub to the Access Point's RJ45 jack will allow a number of computers connected to the switch access to the rest of the network.

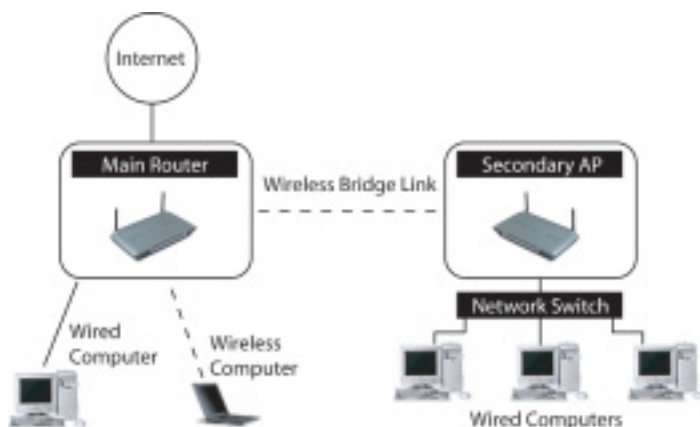

## USING THE WEB-BASED ADVANCED USER INTERFACE

### Setting Up a Bridge Between your Wireless Router and a Secondary Access Point

Bridging your Belkin Router to a secondary Access Point requires that you access the Router's Advanced Setup Utility and enter the MAC address of the Access Point in the appropriate area. There are also a few other requirements. PLEASE BE SURE TO FOLLOW THE STEPS BELOW, CAREFULLY.

1. Set your Access Point to the same channel as the Router. By default, the Router and Access Point channels are set to channel 11 at the factory. If you have never changed the channel, you don't need to do anything.
2. Find the Access Point's MAC address on the bottom label of the Access Point. There are two MAC addresses on the bottom label. You will need the MAC address named "WLAN MAC Address". The MAC address starts with 0030BD and is followed by six other numbers or letters (i.e. 0030BD-XXXXXX). Write the MAC address below. Go to the next step.

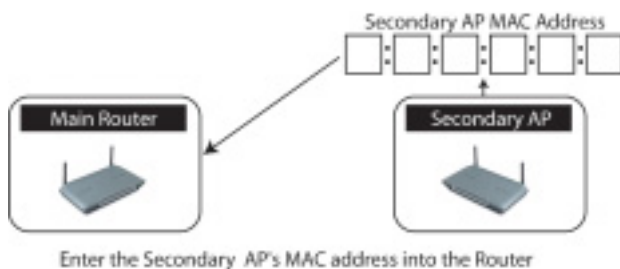

3. Place your secondary Access Point within range of your Wireless Router and near the area where you want to extend the range or add the network segment. Typically, indoor range should be between 50 and 150 feet.
4. Connect power to your Access Point. Make sure the Access Point is on and proceed to the next step.
5. From a computer already connected to your Router, access the Advanced Setup Utility by opening your browser. In the address bar, type in "192.168.2.1". Do not type in "www" or "http://" before the number.  
**Note: If you have changed your Router's IP address, use that IP address.**

## USING THE WEB-BASED ADVANCED USER INTERFACE

- You will see the Router's user interface in the browser window. Click "Wireless Bridge" (2) on the left-hand side of the screen. You will see the following screen.

The screenshot shows the Belkin router's web-based user interface. The left sidebar contains a menu with the following items: LAN Setup, LAN Settings, DHCP Grant List, Internet WPA, Connection Type, DNS, MAC Address, **Wireless**, Channel and SSID, Encryption, Use as Access Point, **Wireless Bridge**, Firewall, Virtual Servers, Client IP Filter, MAC Address Filtering, DMZ, WAN Ping Blocking, Security Log, Utilities, Parental Control, Restart Router, Restore Factory Default, Device/Setup Settings, Restore Previous Settings, Firmware Update, and System Settings. The 'Wireless' menu item is selected, and the 'Wireless Bridge' sub-item is circled in red and labeled (2). The main content area displays the 'Wireless > Wireless bridge' configuration page. It includes a title bar, a description of Wireless Bridging, and two checkboxes: 'Enable Wireless Bridging' (checked) and 'Enable ONLY specific Access Points to connect' (checked). The 'Enable ONLY specific Access Points to connect' checkbox is circled in red and labeled (1). Below this checkbox, there are four rows of MAC address input fields for AP1, AP2, AP3, and AP4. The AP1 field is circled in red and labeled (3). At the bottom of the page, there are 'Clear Changes' and 'Apply Changes' buttons.

- Check the box that says "Enable ONLY specific Access Points to connect" (1).
- In the field named AP1 (3), type in the MAC address of your secondary Access Point. When you have typed in the address, click "Apply Changes".
- Bridging is now set up.

# USING THE WEB-BASED ADVANCED USER INTERFACE

## Configuring the Firewall

Your Router is equipped with a firewall that will protect your network from a wide array of common hacker attacks including:

- IP Spoofing
- Land Attack
- Ping of Death (PoD)
- Denial of Service (DoS)
- IP with zero length
- Smurf Attack
- TCP Null Scan
- SYN flood
- UDP flooding
- Tear Drop Attack
- ICMP defect
- RIP defect
- Fragment flooding

The firewall also masks common ports that are frequently used to attack networks. These ports appear to be “Stealth” meaning that for all intents and purposes, they do not exist to a would-be hacker. You can turn the firewall function off if needed, however, it is recommended that you leave the firewall enabled. Disabling the firewall protection will not leave your network completely vulnerable to hacker attacks, but it is recommended that you leave the firewall enabled.

The screenshot shows the Belkin Cable/DSL Gateway Router Setup Utility web interface. The top navigation bar includes the Belkin logo, the title "Cable/DSL Gateway Router Setup Utility", and links for "Home", "Help", "Logout", and "Internet Status: Connected". A left-hand navigation menu lists various configuration options, with "Firewall" highlighted in blue. The main content area is titled "Firewall >" and contains the following text: "Your Router is equipped with a firewall that will protect your network from a wide array of common hacker attacks including Ping of Death (PoD) and Denial of Service (DoS) attacks. You can turn the firewall function off if needed, however, it is recommended that you leave the firewall enabled. Disabling the firewall protection will not leave your network completely vulnerable to hacker attacks, but it is recommended that you turn the firewall on whenever possible." Below this text, there is a "Firewall Enable / Disable" section with radio buttons for "Disable" and "Enable", where "Enable" is selected. At the bottom of this section are two buttons: "Clear Changes" and "Apply Changes".

# USING THE WEB-BASED ADVANCED USER INTERFACE

## Configuring Internal Forwarding Settings

The Virtual Servers function will allow you to route external (Internet) calls for services such as a web server (port 80), FTP server (Port 21), or other applications through your Router to your internal network. Since your internal computers are protected by a firewall, computers outside your network (over the Internet) cannot get to them because they cannot be “seen”. A list of common applications has been provided in case you need to configure the Virtual Server function for a specific application. If your application is not listed, you will need to contact the application vendor to find out which port settings you need.

Belkin Cable/DSL gateway Router Setup Utility

Home Help Logout Internet Status

### Firewall > Virtual servers

This function will allow you to route external (Internet) calls for services such as a web server (port 80), FTP server (Port 21), or other applications through your Router to your internal network. Name Info

Clear Changes Apply Changes

add Apple Works Add

clear entry Clear

	Enable	Description	Inbound port	Type	Private IP address	Private port
1.	<input type="checkbox"/>			TCP	192.168.2	
2.	<input type="checkbox"/>			TCP	192.168.2	
3.	<input type="checkbox"/>			TCP	192.168.2	
4.	<input type="checkbox"/>			TCP	192.168.2	

## Choosing an Application

Select your application from the drop-down list. Click “Add”. The settings will be transferred to the next available space in the screen. Click “Apply Changes” to save the setting for that application. To remove an application, select the number of the row that you want to remove then click “Clear”.

## Manually Entering Settings into the Virtual Server

To manually enter settings, enter the IP address in the space provided for the internal (server) machine, the port(s) required to pass (use a comma between multiple ports), select the port type (TCP or UDP), and click “Apply Changes”. You can only pass one port per internal IP address. Opening ports in your firewall can pose a security risk. You can enable and disable settings very quickly. It is recommended that you disable the settings when you are not using a specific application.

# USING THE WEB-BASED ADVANCED USER INTERFACE

## Setting Client IP Filters

The Router can be configured to restrict access to the Internet, e-mail, or other network services at specific days and times. Restriction can be set for a single computer, a range of computers, or multiple computers.

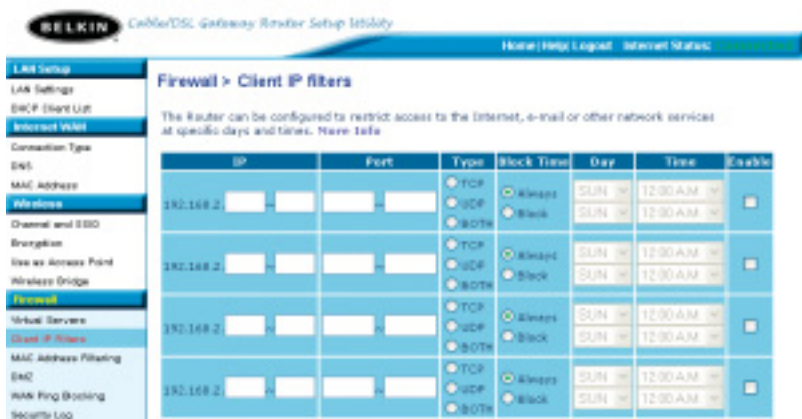

To restrict Internet access to a single computer for example, enter the IP address of the computer you wish to restrict access to in the IP fields (1). Next, enter "88" in both the port fields (2). Select "Both" (3). Select "Block" (4). You can also select "Always" to block access all of the time. Select the day to start on top (5), the time to start on top (6), the day to end on the bottom (7), and the time to stop (8) on the bottom. Select "Enable" (9). Click "Apply Changes". The computer at the IP address you specified will now be blocked from Internet access at the times you specified. Note: Be sure you have selected the correct time zone under "Utilities> System Settings> Time Zone".

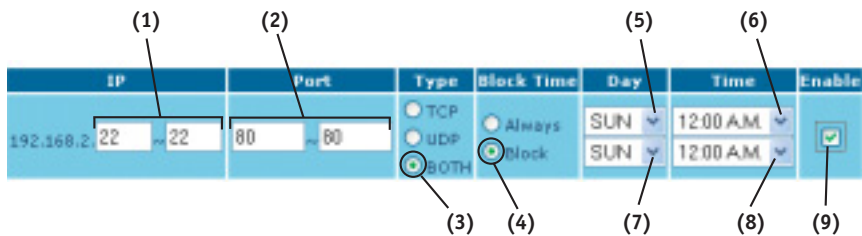

# USING THE WEB-BASED ADVANCED USER INTERFACE

## Setting MAC Address Filtering

The MAC address filter is a powerful security feature that allows you to specify which computers are allowed on the network. Any computer attempting to access the network that is not specified in the filter list will be denied access. When you enable this feature, you must enter the MAC address of each client (computer) on your network to allow network access to each. The “Block” feature lets you turn on and off access to the network easily for any computer without having to add and remove the computer’s MAC address from the list.

The screenshot shows the Belkin CaMerDxL Gateway Router Setup Utility interface. The left sidebar contains a navigation menu with options like LAN Setup, DHCP Client List, Wireless WMM, Connection Type, DNS, MAC Address, Wireless, Channel and SSID, Encryption, Use as Access Point, Wireless Bridge, Firewall, Virtual Servers, Client IP Filters, MAC Address Filtering (highlighted), DNS, WAN Ping Blocking, Security Log, IS Filters, Parental Control, Restart Router, Restore Factory Default, and Save/Backup Settings. The main content area is titled 'Firewall > MAC Address Filtering'. It includes a description: 'This feature lets you set up a list of allowed clients. When you enable this feature, you must enter the MAC address of each client on your network to allow network access to each. [More Info](#)'. Below this is a checkbox labeled 'Enable MAC Address Filtering >' which is checked. Underneath is a table titled 'MAC Address Filtering List >'. The table has three columns: 'Block', 'Host', and 'MAC Address'. The 'Block' column contains a checkbox, the 'Host' column is empty, and the 'MAC Address' column contains a text input field. To the right of the input field is a button labeled '<< Add'. Below the table are two buttons: 'Clear Changes' and 'Apply Changes'. Three numbered callouts (1, 2, 3) point to the 'Enable MAC Address Filtering' checkbox, the 'MAC Address' input field, and the '<< Add' button, respectively.

To enable this feature, select “Enable MAC Address Filtering” (1). Next, enter the MAC address of each computer on your network by clicking in the space provided (2) and entering the MAC address of the computer you want to add to the list. Click “Add” (3), then “Apply Changes” to save the settings. To delete a MAC address from the list, simply click “Delete” next to the MAC address you wish to delete. Click “Apply Changes” to save the settings.

**Note:** You will not be able to delete the MAC address of the computer you are using to access the Router’s administrative functions (the computer you are using now).

# USING THE WEB-BASED ADVANCED USER INTERFACE

## Enabling the Demilitarized Zone (DMZ)

The DMZ feature allows you to specify one computer on your network to be placed outside of the firewall. This may be necessary if the firewall is causing problems with an application such as a game or video conferencing application. Use this feature on a temporary basis. The computer in the DMZ is NOT protected from hacker attacks.



To put a computer in the DMZ, enter the last digits of its IP address in the IP field and select "Enable". Click "Apply Changes" for the change to take effect. If you are using multiple static WAN IP addresses, it is possible to select which WAN IP address the DMZ host will be directed to. Type in the WAN IP address you wish the DMZ host to direct to, enter the last two digits of the IP address of the DMZ host computer, select "Enable" and click "Apply Changes".



# USING THE WEB-BASED ADVANCED USER INTERFACE

## Blocking an ICMP Ping

Computer hackers use what is known as “pinging” to find potential victims on the Internet. By pinging a specific IP address and receiving a response from the IP address, a hacker can determine that something of interest might be there. The Router can be set up so it will not respond to an ICMP ping from the outside. This heightens the level of security of your Router.

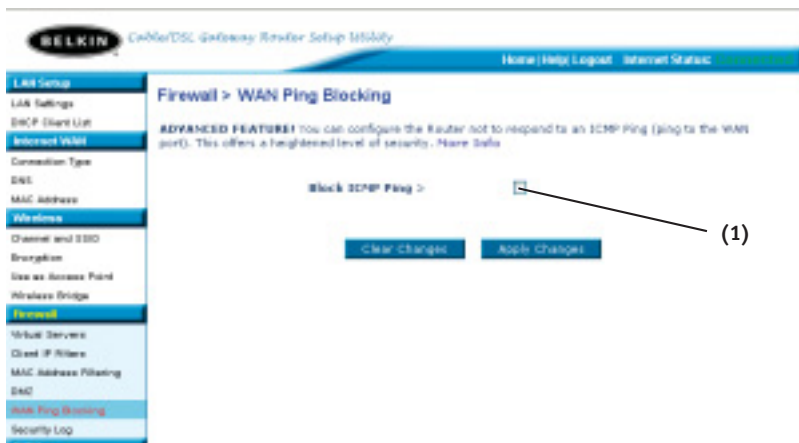

To turn off the ping response, select “Block ICMP Ping” **(1)** and click “Apply Changes”. The Router will not respond to an ICMP ping.

# USING THE WEB-BASED ADVANCED USER INTERFACE

## Utilities Tab

### Utilities

This screen lets you manage different parameters of the Router and perform certain administrative functions.

**BELKIN** Cable/DSL Gateway Router Setup Utility

Home / Help / Logout / Internet Status

### Utilities > Restart Router

This screen lets you manage different parameters of the Router and perform certain administrative functions.

- Parental Control**  
Belkin's Parental Control protects you and your kids from objectionable content on the web. Belkin's Parental Control is the filter you set up. Now you can surf the net with your kids except when you are not there.
- Restart Router**  
Sometimes it may be necessary to Reset or Reboot the Router if it begins working improperly. Resetting or Rebooting the Router will not delete any of your configuration settings.
- Restore Default Settings**  
Using this option will restore all of the settings in the Router to the factory (default) settings. It is recommended that you backup your settings before you restore all of the defaults.
- Save Current Configuration**  
You can save your current configuration by using this feature. Saving your configuration will allow you to restore it later if your settings are lost or changed. It is recommended that you backup your current configuration before performing a firmware update.
- Restore Previous Configuration**  
This option will allow you to restore a previously saved configuration.
- Firmware Update**  
From time to time, Belkin may release new versions of the Router's firmware. Firmware updates contain feature improvements and fixes to problems that may have existed.
- System Settings**  
The System Settings page is where you can enter a new administrator password, set the time zone, enable remote management and turn an on and off the NAT function of the Router.

## Parental Control

See separate Parental Control User Manual from Belkin.

## USING THE WEB-BASED ADVANCED USER INTERFACE

### Restarting the Router

Sometimes it may be necessary to restart or reboot the Router if it begins working improperly. Restarting or rebooting the Router will NOT delete any of your configuration settings.

### Restarting the Router to Restore Normal Operation

1. Click the "Restart Router" button.

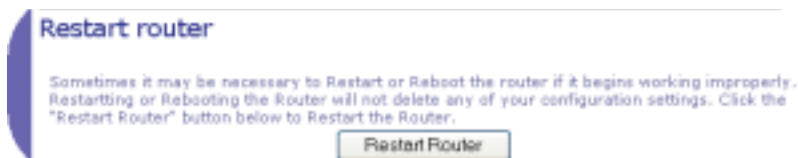

2. The following message will appear. Click "OK".

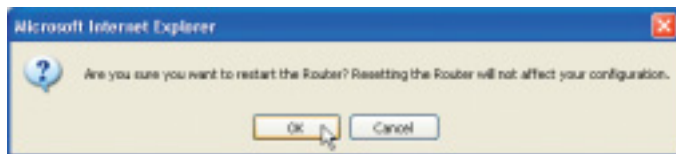

3. The following message will appear. Restarting the Router can take up to 60 seconds. It is important not to turn off the power to the Router during the restart.

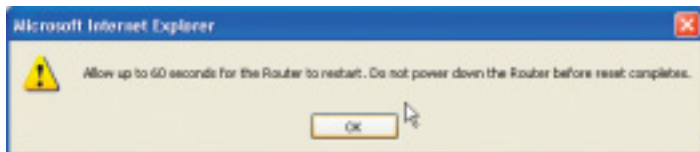

4. A 60-second countdown will appear on the screen. When the countdown reaches zero, the Router will be restarted. The Router home page should appear automatically. If not, type in the Router's address (default = 192.168.2.1) into the navigation bar of your browser.

## USING THE WEB-BASED ADVANCED USER INTERFACE

### Restoring Factory Default Settings

Using this option will restore all of the settings in the Router to the factory (default) settings. It is recommended that you back up your settings before you restore all of the defaults.

#### Utilities > Restore Factory Defaults

Restore factory defaults

Using this option will restore all of the settings in the Router to the factory (default) settings. It is recommended that you backup your settings before you restore all of the defaults. To restore the factory default settings, click the "Restore Defaults" button below.

Restore Defaults

1. Click the "Restore Defaults" button.
2. The following message will appear. Click "OK".

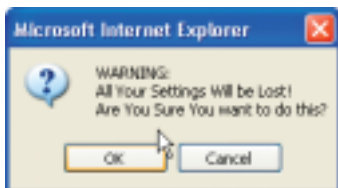

3. The following message will appear. Restoring the defaults includes restarting the Router. It can take up to 60 seconds. It is important not to turn the power to the Router off during the restart.

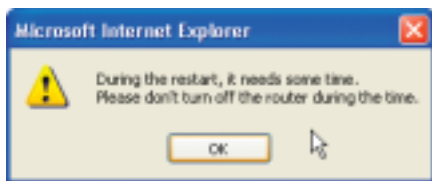

4. A 60-second countdown will appear on the screen. When the countdown reaches zero, the Router's defaults will be restored. The Router home page should appear automatically. If it does not, type in the Router's address (default = 192.168.2.1) into the navigation bar of your browser.

## USING THE WEB-BASED ADVANCED USER INTERFACE

### Saving a Current Configuration

You can save your current configuration by using this feature. Saving your configuration will allow you to restore it later if your settings are lost or changed. It is recommended that you back up your current configuration before performing a firmware update.

#### Utilities > Save/Backup current settings

You can save your current configuration by using this feature. Saving your configuration will allow you to restore it later if your settings are lost or changed. It is recommended that you backup your current configuration before performing a firmware update.

A blue rectangular button with the word "Save" in white text.

1. Click "Save". A window called "File Download" will open. Click "Save".

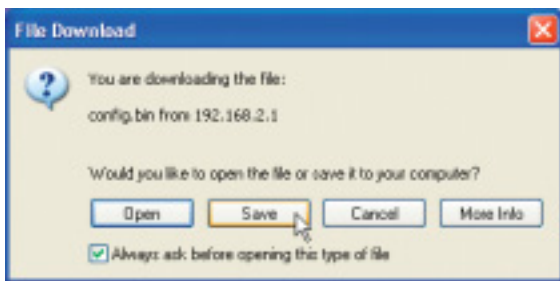

## USING THE WEB-BASED ADVANCED USER INTERFACE

2. A window will open that allows you to select the location where you want to save the configuration file. Select a location. You can name the file anything you want, or use the default name “Config”. Be sure to name the file so you can locate it yourself later. When you have selected the location and name of the file, click “Save”.

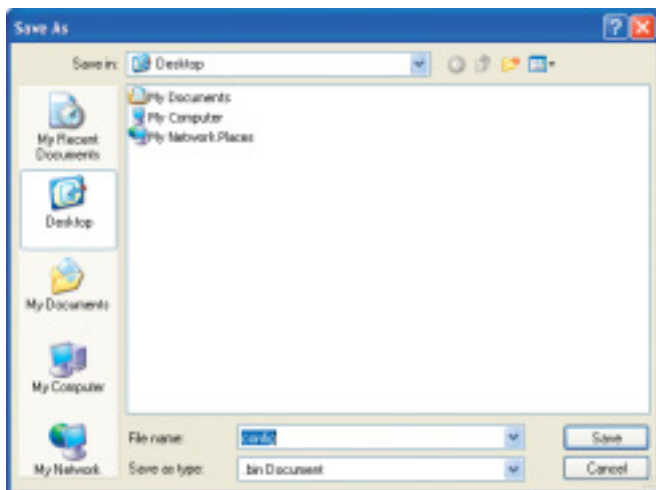

3. When the save is complete, you will see the window below. Click “Close”.

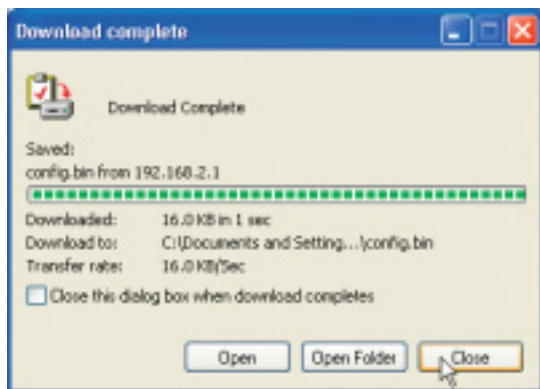

The configuration is now saved.

## USING THE WEB-BASED ADVANCED USER INTERFACE

### Restoring a Previous Configuration

This option will allow you to restore a previously saved configuration.

#### Utilities > Restore Previous Settings

This option will allow you to restore a previously saved configuration.



1. Click "Browse". A window will open that allows you to select the location of the configuration file. All configuration files end with a ".bin". Locate the configuration file you want to restore and double-click on it.

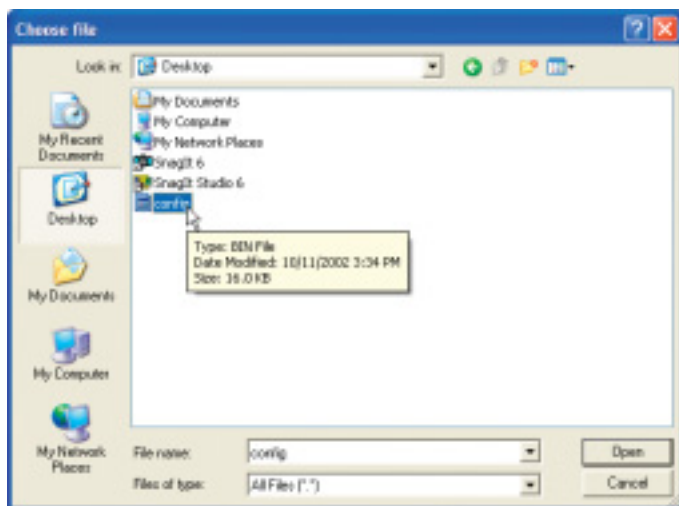

## USING THE WEB-BASED ADVANCED USER INTERFACE

2. You will be asked if you want to continue. Click "OK".

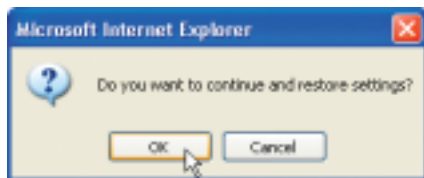

3. A reminder window will appear. It will take up to 60 seconds for the configuration restoration to complete. Click "OK".

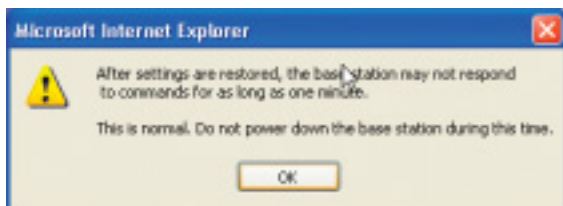

4. A 60-second countdown will appear on the screen. When the countdown reaches zero, the Router's configuration will be restored. The Router home page should appear automatically. If not, type in the Router's address (default = 192.168.2.1) into the navigation bar of your browser.



## USING THE WEB-BASED ADVANCED USER INTERFACE

### Updating Firmware

From time to time, Belkin may release new versions of the Router's firmware. Firmware updates contain feature improvements and fixes to problems that may have existed. When Belkin releases new firmware, you can download the firmware from the Belkin update website and update your Router's firmware to the latest version.

**Firmware Update**

From time to time, Belkin may release new versions of the Router's firmware. Firmware updates contain improvements and fixes to problems that may have existed. Click the link below to see if there is a new firmware update available for this Router.

NOTE: Please backup your current settings before updating to a new version of firmware. [Click Here](#) to go to the Save/Backup current settings page.

**Check For New Firmware Version**

Update Firmware >

Check Firmware (1)

Browse... (2)

Update

### Checking for a New Version of Firmware

The "Check Firmware" (1) button allows you to instantly check for a new version of firmware. When you click the button, a new browser window will appear informing you that either no new firmware is available or that there is a new version available. If a new version is available, you will have the option to download it.

## USING THE WEB-BASED ADVANCED USER INTERFACE

### Downloading a New Version of Firmware

If you click the “Check Firmware” button and a new version of firmware is available, you will see a screen such as the following.

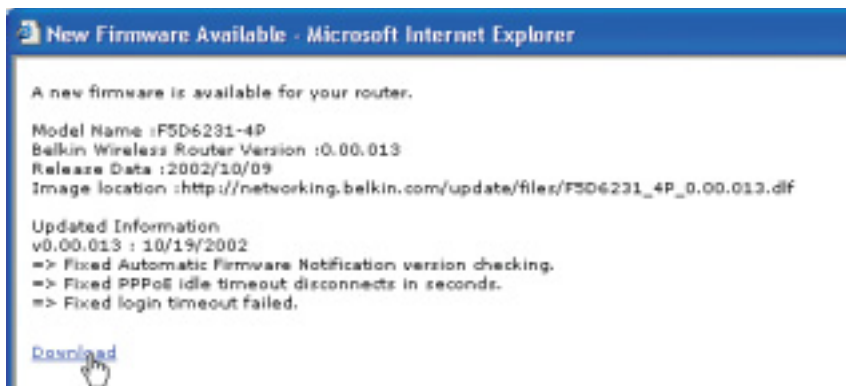

1. To download the new version of firmware, click “Download”.
2. A window will open that allows you to select the location where you want to save the firmware file. Select a location. You can name the file anything you want, or use the default name. Be sure to locate the file in a place where you can locate it yourself later. When you have selected the location, click “Save”.

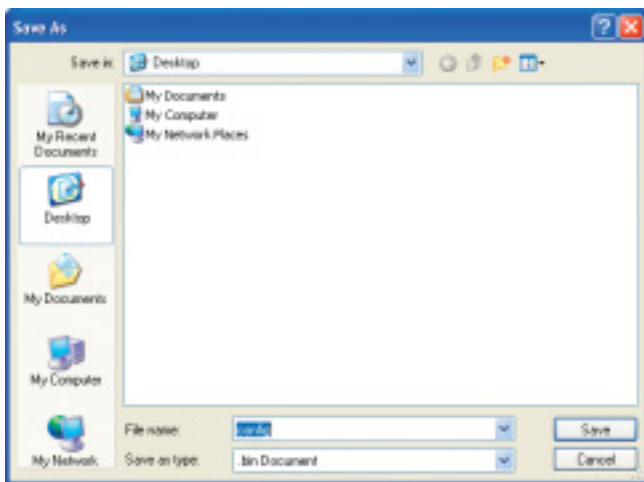

## USING THE WEB-BASED ADVANCED USER INTERFACE

- When the save is complete, you will see the following window. Click “Close”.

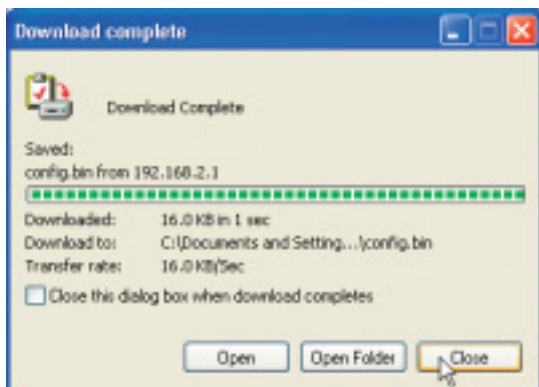

The download of the firmware is complete. To update the firmware, follow the next steps in “Updating the Router’s Firmware”.

### Updating the Router’s Firmware

- In the “Firmware Update” page, click “Browse” (2). A window will open that allows you to select the location of the firmware update file. All firmware files end with a “.dlf”.



- Browse to the firmware file you downloaded. Select the file by double-clicking on the file name.

## USING THE WEB-BASED ADVANCED USER INTERFACE

3. The “Update Firmware” box will now display the location and name of the firmware file you just selected. Click “Update”.

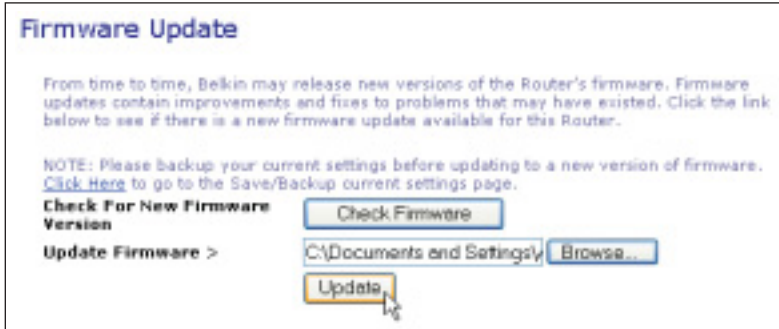

4. You will be asked if you are sure you want to continue. Click “OK”.

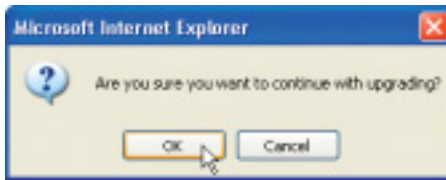

5. You will see one more message. This message tells you that the Router may not respond for as long as one minute as the firmware is loaded into the Router and the Router is rebooted. Click “OK”.



6. A 60-second countdown will appear on the screen. When the countdown reaches zero, the Router firmware update will be complete. The Router home page should appear automatically. If not, type in the Router's address (default = 192.168.2.1) into the navigation bar of your browser.

The firmware update is complete.

## USING THE WEB-BASED ADVANCED USER INTERFACE

### Changing System Settings

The “System Settings” page is where you can enter a new administrator password, set the time zone, enable remote management, and turn on and off the NAT function of the Router.

### Setting or Changing the Administrator Password

The Router ships with NO password entered. If you wish to add a password for greater security, you can set a password here. Write down your password and keep it in a safe place, as you will need it if you need to log into the Router in the future. It is also recommended that you set a password if you plan to use the remote management feature of your Router.

#### Administrator Password:

The Router ships with NO password entered. If you wish to add a password for more security, you can set a password here. [More Info](#)

- Type in current Password >

- Type in new Password >

- Confirm new Password >

- Login Timeout >

 (1-99 minutes)

### Changing the Login Timeout Setting

The login timeout option allows you to set the period of time that you can be logged into the Router’s advanced setup interface. The timer starts when there has been no activity. For example, you have made some changes in the advanced setup interface, then left your computer alone without clicking “Logout”. Assuming the timeout is set to 10 minutes, then 10 minutes after you leave, the login session will expire. You will have to login to the Router again to make any more changes. The login timeout option is for security purposes and the default is set to 10 minutes. *Note: Only one computer can be logged into the Router’s advanced setup interface at one time.*

## USING THE WEB-BASED ADVANCED USER INTERFACE

### Setting the Time and Time Zone

The Router keeps time by connecting to a Simple Network Time Protocol (SNTP) server. This allows the Router to synchronize the system clock to the global Internet. The synchronized clock in the Router is used to record the security log and control client filtering. Select the time zone that you reside in. If you reside in an area that observes Daylight Saving, then place a check mark in the box next to "Enable Daylight Saving". The system clock may not update immediately. Allow at least 15 minutes for the Router to contact the time servers on the Internet and get a response. You cannot set the clock yourself.

**Time and Time Zone:** April 22, 2003 11:12:36 AM  
Please set your time Zone. If you are in an area that observes daylight saving check this box. [More Info](#)

- Time Zone > [GMT-08:00] Pacific Time (US & Canada): Tijuana ▾

- Daylight Savings >  Automatically Adjust Daylight Saving

### Enabling Remote Management

Before you enable this advanced feature of your Belkin Router, **MAKE SURE YOU HAVE SET THE ADMINISTRATOR PASSWORD**. Remote management allows you to make changes to your Router's settings from anywhere on the Internet. There are two methods of remotely managing the Router. The first is to allow access to the Router from anywhere on the Internet by selecting "Any IP address can remotely manage the Router". By typing in your WAN IP address from any computer on the Internet, you will be presented with a login screen where you need to type in the password of your Router. The second method is to allow a specific IP address only to remotely manage the Router. This is more secure, but less convenient. To use this method, enter the IP address you know you will be accessing the Router from in the space provided and select "Only this IP address can remotely manage the Router". Before you enable this function, it is **STRONGLY RECOMMENDED** that you set your administrator password. Leaving the password empty will potentially open your Router to intrusion.

#### Remote Management:

**ADVANCED FEATURE!** Remote management allows you to make changes to your Router's settings from anywhere on the Internet. Before you enable this function, **MAKE SURE YOU HAVE SET THE ADMINISTRATOR PASSWORD**. [More Info](#)

Any IP address can remotely manage the router.

- Only this IP address can remotely manage the router>  .  .  .

## USING THE WEB-BASED ADVANCED USER INTERFACE

### Enabling/Disabling NAT (Network Address Translation)

**Note:** *This advanced feature should be employed by advanced users only.*

Before enabling this function, **MAKE SURE YOU HAVE SET THE ADMINISTRATOR PASSWORD.** Network Address Translation (NAT) is the method by which the Router shares the single IP address assigned by your ISP with the other computers on your network. This function should only be used if your ISP assigns you multiple IP addresses or you need NAT disabled for an advanced system configuration. If you have a single IP address and you turn NAT off, the computers on your network will not be able to access the Internet. Other problems may also occur. Turning off NAT will disable your firewall functions.

#### NAT Enabling:

**ADVANCED FEATURE!** Allows you to turn the Network Address Translation feature of the Router off. In almost every case you would NOT want to turn this feature off. [More Info](#)

- NAT Enable / Disable >

Enable  Disable

### Enabling/Disabling UPnP

UPnP (Universal Plug-and-Play) is yet another advanced feature offered by your Belkin Router. It is a technology that offers seamless operation of voice messaging, video messaging, games, and other applications that are UPnP-compliant. Some applications require the Router's firewall to be configured in a specific way to operate properly. This usually requires opening TCP and UDP ports, and in some instances, setting trigger ports. An application that is UPnP-compliant has the ability to communicate with the Router, basically "telling" the Router which way it needs the firewall configured. The Router ships with the UPnP feature disabled. If you are using any applications that are UPnP-compliant, and wish to take advantage of the UPnP features, you can enable the UPnP feature. Simply select "Enable" in the "UPnP Enabling" section of the "Utilities" page. Click "Apply Changes" to save the change.

#### UPnP Enabling:

**ADVANCED FEATURE!** Allows you to turn the UPnP feature of the Router off. [More Info](#)

- UPnP Enable / Disable >

Enable  Disable

## USING THE WEB-BASED ADVANCED USER INTERFACE

### Enabling/Disabling Auto Firmware Update

This innovation provides the Router with the built-in capability to automatically check for a new version of firmware and alert you that the new firmware is available. When you log into the Router's advanced interface, the Router will perform a check to see if new firmware is available. If so, you will be notified. You can choose to download the new version or ignore it. The Router ships with this feature enabled. If you want to disable it, select "Disable" and click "Apply Changes".

#### Auto Update Firmware Enabling:

**ADVANCED FEATURE!** Allows you to update firmware automatically of the Router off. [More Info](#)

- Auto Update Firmware **Enable /**  Enable  Disable **Disable >**



## MANUALLY CONFIGURING NETWORK SETTINGS

Set up the computer that is connected to the cable or DSL modem FIRST using these steps. You can also use these steps to add computers to your Router after the Router has been set up to connect to the Internet.

### Manually Configuring Network Settings in Mac OS up to 9.x

1. Pull down the Apple menu. Select “Control Panels” and select “TCP/IP”.
2. You will see the TCP/IP control panel. Select “Ethernet Built-In” or “Ethernet” in the “Connect via:” drop-down menu (1).

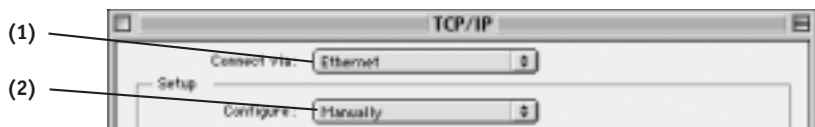

3. Next to “Configure” (2), if “Manually” is selected, your Router will need to be set up for a static IP connection type. Write the address information in the table below. You will need to enter this information into the Router.

IP Address:	<input type="text"/>
Subnet Mask:	<input type="text"/>
Router Address:	<input type="text"/>
Name Server Address:	<input type="text"/>

4. If not already set, at “Configure:”, choose “Using DHCP Server”. This will tell the computer to obtain an IP address from the Router.

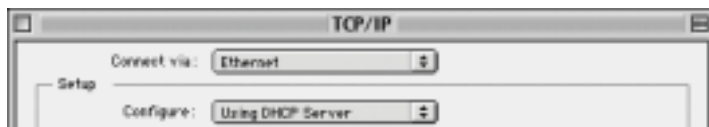

5. Close the window. If you made any changes, the following window will appear. Click “Save”.



Restart the computer. When the computer restarts, your network settings are now configured for use with the Router.

# MANUALLY CONFIGURING NETWORK SETTINGS

## Manually Configuring Network Settings in Mac OS X

1. Click on the “System Preferences” icon.



2. Select “Network” (1) from the “System Preferences” menu.



3. Select “Built-in Ethernet” (2) next to “Show” in the Network menu.

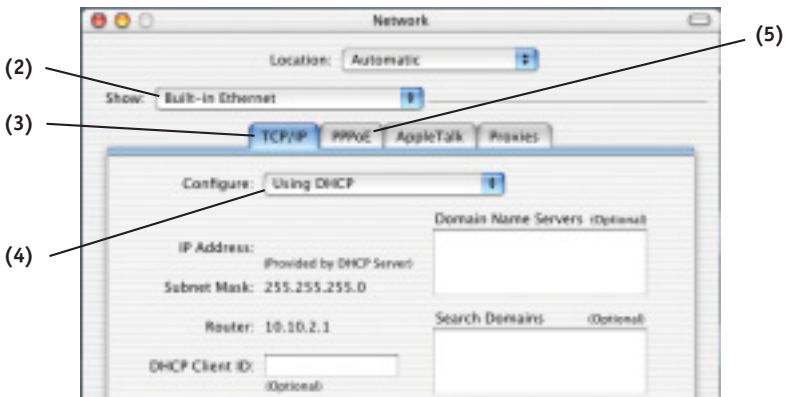

## MANUALLY CONFIGURING NETWORK SETTINGS

4. Select the “TCP/IP” tab **(3)**. Next to “Configure” **(4)**, you should see “Manually” or “Using DHCP”. If you do not, check the PPPoE tab **(5)** to make sure that “Connect using PPPoE” is NOT selected. If it is, you will need to configure your Router for a PPPoE connection type using your user name and password.
5. If “Manually” is selected, your Router will need to be set up for a static IP connection type. Write the address information in the table below. You will need to enter this information into the Router.

IP address:	<input type="text"/>
Subnet Mask:	<input type="text"/>
Router Address:	<input type="text"/>
Name Server Address:	<input type="text"/>

6. If not already selected, select “Using DHCP” next to “Configure” **(4)**, then click “Apply Now”.

Your network settings are now configured for use with the Router.

# MANUALLY CONFIGURING NETWORK SETTINGS

## Manually Configuring Network Settings in Windows 2000, NT, or XP

1. Click “Start”, “Settings”, then “Control Panel”.
2. Double-click on the “Network and dial-up connections” icon (Windows 2000) or the “Network” icon (Windows XP).
3. Right-click on the “Local Area Connection” associated with your network adapter and select “Properties” from the drop-down menu.
4. In the “Local Area Connection Properties” window, click “Internet Protocol (TCP/IP)” and click the “Properties” button. The following screen will appear:

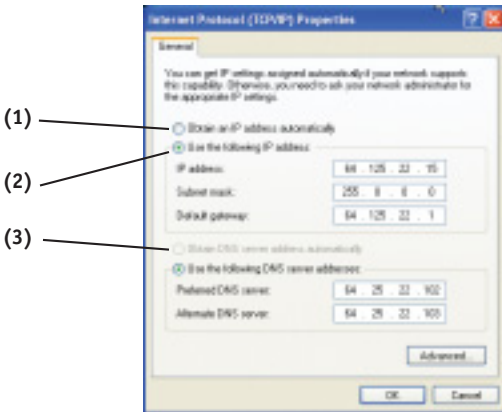

5. If “Use the following IP address” (2) is selected, your Router will need to be set up for a static IP connection type. Write the address information the table below. You will need to enter this information into the Router.

IP address:	<input type="text"/>
Subnet Mask:	<input type="text"/>
Default gateway:	<input type="text"/>
Preferred DNS server:	<input type="text"/>
Alternate DNS server:	<input type="text"/>

6. If not already selected, select “Obtain an IP address automatically” (1) and “Obtain DNS server address automatically” (3). Click “OK”.

Your network settings are now configured for use with the Router.

# MANUALLY CONFIGURING NETWORK SETTINGS

## Manually Configuring Network Settings in Windows 98 or Me

1. Right-click on “My Network Neighborhood” and select “Properties” from the drop-down menu.
2. Select “TCP/IP -> settings” for your installed network adapter. You will see the following window.

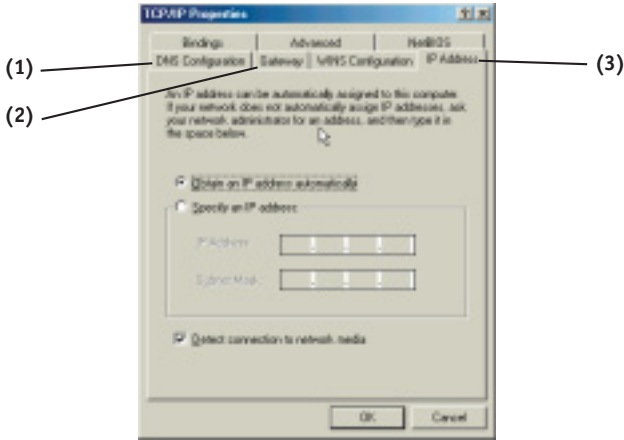

3. If “Specify and IP address” is selected, your Router will need to be set up for a static IP connection type. Write the address information in the table below. You will need to enter this information into the Router.
4. Write the IP address and subnet mask from the “IP Address” tab (3).
5. Click the “Gateway” tab (2). Write the gateway address down in the chart.
6. Click the “DNS Configuration” tab (1). Write the DNS address(es) in the chart.

IP address:	<input type="text"/>
Subnet Mask:	<input type="text"/>
Default gateway:	<input type="text"/>
Preferred DNS server:	<input type="text"/>
Alternate DNS server:	<input type="text"/>

7. If not already selected, select “Obtain IP address automatically” on the IP address tab. Click “OK”.

Restart the computer. When the computer restarts, your network settings are now configured for use with the Router.

## RECOMMENDED WEB BROWSER SETTINGS

In most cases, you will not need to make any changes to your web browser's settings. If you are having trouble accessing the Internet or the advanced web-based user interface, then change your browser's settings to the recommended settings in this section.

### Internet Explorer 4.0 or Higher

1. Start your web browser. Select "Tools" then "Internet Options".

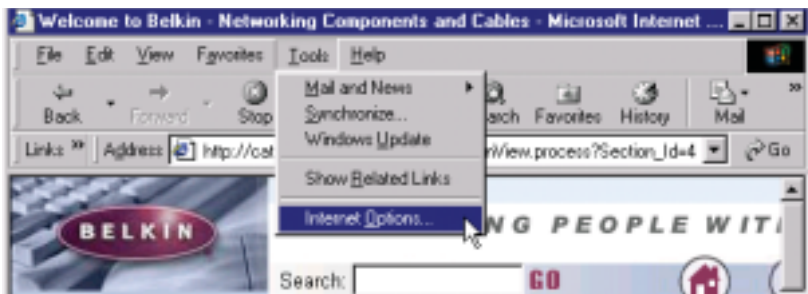

2. In the "Internet Options" screen, there are three selections: "Never dial a connection", "Dial whenever a network connection is not present", and "Always dial my default connection". If you can make a selection, select "Never dial a connection". If you cannot make a selection, go to the next step.

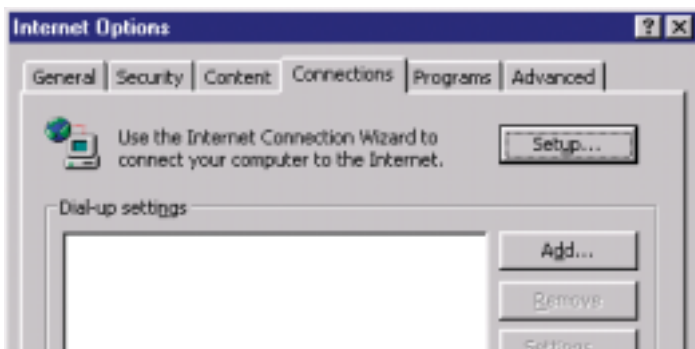

## RECOMMENDED WEB BROWSER SETTINGS

3. Under the “Internet Options” screen, click on “Connections” and select “LAN Settings...”.
4. Make sure there are no check marks next to any of the displayed options: “Automatically detect settings”, “Use automatic configuration script”, and “Use a proxy server”. Click “OK”. Then click “OK” again in the “Internet Options” page.

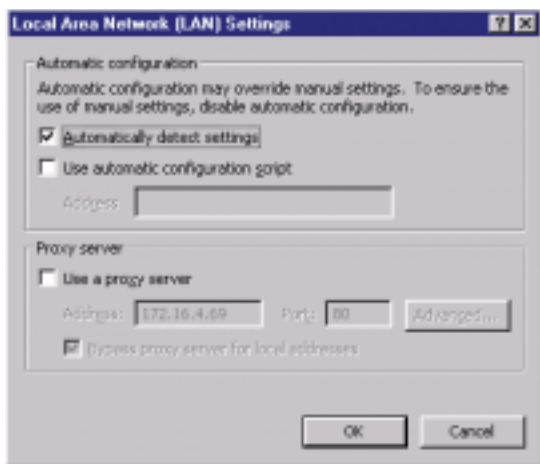

## RECOMMENDED WEB BROWSER SETTINGS

### Netscape Navigator 4.0 or Higher

1. Start Netscape. Click on “Edit” then “Preferences”.
2. In the “Preferences” window, click on “Advanced” then select “Proxies”. In the “Proxies” window, select “Direct connection to the Internet”.

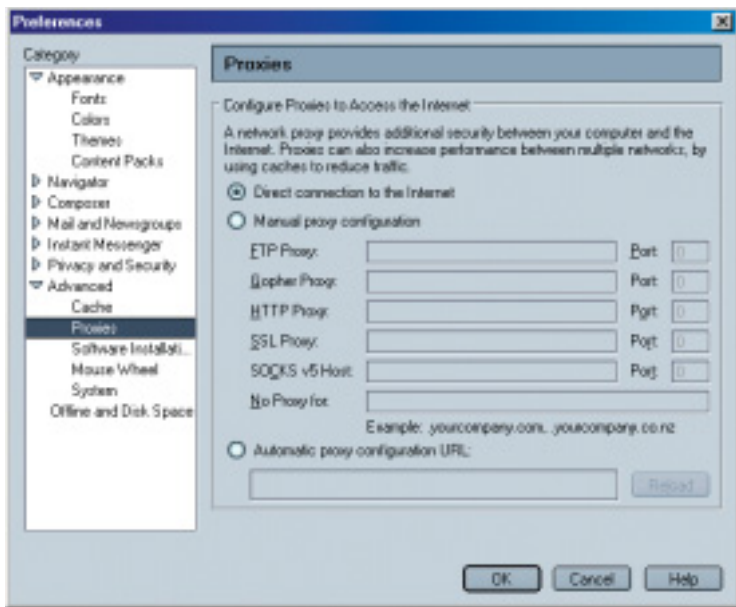



## TROUBLESHOOTING

You can find technical support information at [www.networking.belkin.com](http://www.networking.belkin.com) or [www.belkin.com](http://www.belkin.com) through the tech support area. If you want to contact technical support by phone, please call 800-223-5546. Technical support is available 24 hours a day, 7 days a week.

### Problem

**The Easy Install Wizard is not able to connect my Router to the Internet.**

### Possible Cause/Solution

1. The software must be run from the computer that is connected to the modem. The Internet connection must be active and working at the time of installation. Connect your computer back to the modem and make sure the Internet connection is working. Once you have verified that the Internet connection is working, run the Easy Install Wizard again.
2. If your ISP requires a user name and password, make sure that you have typed in your user name and password correctly. Some user names require that the ISP's domain be at the end of the name. Example "myname@myisp.com". The "@myisp.com" part of the user name may need to be typed as well as your user name.
3. Make sure that the modem is ON. Check the wall adapter and the power connection at the modem. Some modems have a power switch. Make sure the power switch is in the ON position.

## TROUBLESHOOTING

### **The Easy Install Wizard is not able to find my Router.**

1. Make sure that the Router is ON. The Power/Ready light will be on GREEN and SOLID. Check the power supply connection at the wall and the Router.
2. Make sure that the LAN link light that corresponds to the port you connected to the computer is ON. Check the network cable going from the computer to the Router.
3. If the Easy Install Wizard told you that it detected multiple network adapters, run the Easy Install Wizard again and try a different adapter.

### **The WAN link LED is not on or I cannot connect to the cable or DSL modem.**

1. Check the connection between the Router and the cable or DSL modem. Make sure the network cable from the cable or DSL modem is connected to the port on the Router labeled "Internet/WAN".
2. Make sure the cable or DSL modem is powered and switched on.
3. Make sure the Router has power. The Power/Ready LED should be illuminated.
4. Make sure the cable between the modem and the Router is the cable that was provided with the modem.

## TROUBLESHOOTING

**My connection type is “static IP address”. I cannot connect to the Internet.**

1. Since your connection type is “static IP address”, your ISP must assign you the IP address, subnet mask, and gateway address. Make sure that the Router’s connection type is configured as “Static IP Address” and verify your settings.
2. Your ISP may bind your connection to the MAC address of your computer’s NIC. Clone your MAC address.

**My connection type is “dynamic IP address”. I cannot connect to the Internet.**

1. Make sure your computers are correctly configured and all network cables are properly connected.
2. Make sure the cable or DSL line is properly attached on your cable or DSL modem. Refer to the manual of your modem to verify that it works normally.
3. Make sure the network cable between the modem and the barricade is well connected. Power off the modem; wait a few seconds and then power it on again.
4. Your ISP may bind your connection to the MAC address of your computer’s NIC. Clone your MAC address.

**My connection type is “PPPoE”. I cannot connect to the Internet.**

1. Since your connection type is PPPoE, your ISP will assign you a user name and password and sometimes a service name. Make sure the Router connection type is configured as “PPPoE” and these settings are entered properly.
2. Make sure your computers are correctly configured and all network cables are properly connected.
3. Make sure the coaxial cable or DSL line is properly attached on your cable or DSL modem. Refer to the manual of your modem to verify it works normally.
4. Make sure the network cable between the modem and the Router is well connected. Power off the modem for a few seconds and power on it again.
5. Your ISP may bind your connection to the MAC address of your computer’s NIC. Clone your MAC address.

# INFORMATION

## FCC Statement

### DECLARATION OF CONFORMITY WITH FCC RULES FOR ELECTROMAGNETIC COMPATIBILITY

We, Belkin Corporation, of 501 West Walnut Street, Compton, CA 90220, declare under our sole responsibility that the product,

F5D7230-4

to which this declaration relates, complies with Part 15 of the FCC Rules. Operation is subject to the following two conditions: (1) this device may not cause harmful interference, and (2) this device must accept any interference received, including interference that may cause undesired operation.

## Caution: Exposure to Radio Frequency Radiation.

The radiated output power of this device is far below the FCC radio frequency exposure limits. Nevertheless, the device shall be used in such manner that the potential for human contact normal operation is minimized.

When connecting an external antenna to the device, the antenna shall be placed in such a manner to minimize the potential for human contact during normal operation. In order to avoid the possibility of exceeding the FCC radio frequency exposure limits, human proximity to the antenna shall not be less than 20cm (8 inches) during normal operation.

## Federal Communications Commission Notice

This equipment has been tested and found to comply with the limits for a Class B digital device, pursuant to Part 15 of the FCC Rules. These limits are designed to provide reasonable protection against harmful interference in a residential installation.

This equipment generates, uses, and can radiate radio frequency energy. If not installed and used in accordance with the instructions, it may cause harmful interference to radio or television reception, which can be determined by turning the equipment off and on, the user is encouraged to try and correct the interference by one or more of the following measures:

- Reorient or relocate the receiving antenna.
- Increase the distance between the equipment and the receiver.
- Connect the equipment to an outlet on a circuit different from that to which the receiver is connected.
- Consult the dealer or an experienced radio/TV technician for help.

## Modifications

The FCC requires the user to be notified that any changes or modifications to this device that are not expressly approved by Belkin Corporation may void the users authority to operate the equipment.

## Canada-Industry Canada (IC)

The wireless radio of this device complies with RSS 139 & RSS 210 Industry Canada. This Class B digital complies with Canadian ICES-003.

Cet appareil numérique de la classe B conforme à la norme NMB-003 du Canada.

## Europe-European Union Notice

Radio products with the CE 0682 or CE alert marking comply with the R&TTE Directive (1995/5/EC) issued by the Commission of the European Community.

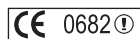

Compliance with this directive implies conformity to the following European Norms (in brackets are the equivalent international standards).

- EN 60950 (IEC60950) – Product Safety
- EN 300 328 Technical requirement for radio equipment
- ETS 300 826 General EMC requirements for radio equipment.



To determine the type of transmitter, check the identification label on your Belkin product.

Products with the CE marking comply with the EMC Directive (89/336/EEC) and the Low Voltage Directive (72/23/EEC) issued by the Commission of the European Community. Compliance with these directives implies conformity to the following European Norms (in brackets are the equivalent international standards).

- EN 55022 (CISPR 22) – Electromagnetic Interference
- EN 55024 (IEC61000-4-2,3,4,5,6,8,11)- Electromagnetic Immunity
- EN 61000-3-2 (IEC61000-3-2) - Power Line Harmonics
- EN 61000-3-3 (IEC61000) – Power Line Flicker
- EN 60950 (IEC60950) – Product Safety



Products that contain the radio transmitter are labeled with CE 0682 or CE alert marking and may also carry the CE logo.

## **Belkin Corporation Limited Lifetime Product Warranty**

Belkin Corporation warrants this product against defects in materials and workmanship for its lifetime. If a defect is discovered, Belkin will, at its option, repair or replace the product at no charge provided it is returned during the warranty period, with transportation charges prepaid, to the authorized Belkin dealer from whom you purchased the product. Proof of purchase may be required.

This warranty does not apply if the product has been damaged by accident, abuse, misuse, or misapplication; if the product has been modified without the written permission of Belkin; or if any Belkin serial number has been removed or defaced.

THE WARRANTY AND REMEDIES SET FORTH ABOVE ARE EXCLUSIVE IN LIEU OF ALL OTHERS, WHETHER ORAL OR WRITTEN, EXPRESSED OR IMPLIED. BELKIN SPECIFICALLY DISCLAIMS ANY AND ALL IMPLIED WARRANTIES, INCLUDING, WITHOUT LIMITATION, WARRANTIES OF MERCHANTABILITY AND FITNESS FOR A PARTICULAR PURPOSE.

No Belkin dealer, agent, or employee is authorized to make any modification, extension, or addition to this warranty.

BELKIN IS NOT RESPONSIBLE FOR SPECIAL, INCIDENTAL, OR CONSEQUENTIAL DAMAGES RESULTING FROM ANY BREACH OF WARRANTY, OR UNDER ANY OTHER LEGAL THEORY, INCLUDING BUT NOT LIMITED TO, LOST PROFITS, DOWNTIME, GOODWILL, DAMAGE TO OR REPROGRAMMING OR REPRODUCING ANY PROGRAM OR DATA STORED IN, OR USED WITH, BELKIN PRODUCTS.

Some states do not allow the exclusion or limitation of incidental or consequential damages or exclusions of implied warranties, so the above limitations of exclusions may not apply to you. This warranty gives you specific legal rights, and you may also have other rights that vary from state to state.







belkin.com

**Belkin Corporation**

501 West Walnut Street  
Compton • CA • 90220 • USA  
Tel: 310.898.1100  
Fax: 310.898.1111

**Belkin Components, Ltd.**

Express Business Park  
Shipton Way • Rushden • NN10 6GL  
United Kingdom  
Tel: +44 (0) 1933 35 2000  
Fax: +44 (0) 1933 31 2000

**Belkin Components B.V.**

Starpac Building • Boeing Avenue 333  
1119 PH Schiphol-Rijk • The Netherlands  
Tel: +31 (0) 20 654 7300  
Fax: +31 (0) 20 654 7349

**Belkin, Ltd.**

7 Bowen Crescent • West Gosford  
NSW 2250 • Australia  
Tel: +61 (0) 2 4372 8600  
Fax: +61 (0) 2 4372 8603

**Belkin Tech Support**

US: 310.898.1100 ext. 2263  
800.223.5546 ext. 2263  
Europe: 00 800 223 55 460  
Australia: 1800 666 040

**P74219-A**