

EnGenius®

Wireless-N 300 + 300Mbps Long Range Ceiling Mount Dual Concurrent Access Point



EAP600

Wireless-N 300 + 300Mbps Long Range Ceiling Mount Dual Concurrent Access Point

V1.0

Table of Contents

1	Introduction	4
1.1	Features and Benefits	4
1.2	Package Contents	5
1.3	System Requirements	6
1.4	Applications	6
2	Before you Begin	9
2.1	Considerations for Wireless Installation	9
2.2	Computer Settings (in Windows XP/Windows 7)	10
2.3	Computer Settings in Apple Mac OS X	13
2.4	Hardware Installation	14
3	Configuring Your Access Point.....	19
3.1	Default Settings.....	19
3.2	Web Configuration	20
4	Building a Wireless Network.....	22
4.1	Access Point Mode	22
4.2	WDS AP Mode	23
4.3	WDS Bridge Mode	24
4.4	Repeater mode	25
5	Status	26
5.1	Save/Reload	26
5.2	Main	27
5.3	2.4G/5G Wireless Client List	30
5.4	2.4G/5G Connection Status	31
5.5	2.4G/5G WDS Link List.....	32
5.6	System Log	33
6	System	34
6.1	Operation Mode	34

6.2	IP Settings.....	35
6.3	Spanning Tree Setting	36
7	2.4G/5G Wireless	38
7.1	Wireless Network	38
7.2	Wireless Security	45
7.3	Site Survey.....	49
7.4	Wireless MAC Filtering.....	53
7.5	Wireless Advanced	55
7.6	WPS (Wi-Fi Protected Setup)	57
7.7	WDS Link Settings	60
8	Management	62
8.1	Administration	62
8.2	Management VLAN Settings.....	63
8.3	Wireless Traffic Shaping	65
8.4	SNMP Settings.....	66
8.5	Backup/Restore	68
8.6	Auto Reboot Settings	69
8.7	Firmware Upgrade	70
8.8	Time Setting.....	71
8.9	Log.....	72
8.10	Diagnostics	73
8.11	LED Control	74
8.12	Logout.....	75
8.13	Reset.....	76
	Appendix A – FCC Interference Statement.....	77
	Appendix B – IC Interference Statement	78
	Appendix C – CE Interference Statement.....	79

Revision History

Version	Date	Notes
1.0	2012/07/30	First Release

1 Introduction

The **EAP600** is a high-powered, long-range dual-band concurrent wireless 802.11a/b/g/n access point with four major functional modes. The EAP600 is designed to operate in numerous environments from large homes, small and medium-sized businesses, multiple-floor offices, hotels and other venues to larger enterprise deployments. Its high-powered, long-range characteristics make it a cost-effective alternative to ordinary access points that don't have the range and reach to connect to a growing number of wireless users who wish to connect to a large home or business network.

The EAP600 supports the 2.4GHz frequency band under 802.11 b/g/n mode while at the same time providing 5GHz band for communicating or transferring files in a less congested network frequency band.

The EAP600 delivers up to 6x faster wireless speeds and 7x extended coverage than legacy 802.11a/b/g wireless devices. Even though the EAP600 has been designed and engineered for traffic heavy and demanding business environments it is also quite at home in larger house scenarios because it efficiently extends the wireless range of an existing home router, especially in very architecturally-challenging structures to provide whole home connectivity.

To protect sensitive data during wireless transmissions, the EAP600 offers different encryption settings for wireless transmissions including industry-standard WPA and WPA2 encryption. The EAP600 also includes MAC address filtering to allow network administrators to offer network access only to known computers and other devices based on their MAC addresses.

1.1 Features and Benefits

Features	Benefits
High Speed Data Rate Up to 300 Mbps for each band (2.4GHz / 5GHz)	Capable of handling heavy data payloads such as HD multimedia streaming.
10/100/1000 Gigabit Ethernet	Support up to 1000Mbps wired networking speed.

IEEE 802.11n Compliant and Backwards Compatible with 802.11 a/b/g devices	Fully compatible with IEEE 802.11 a/b/g/n devices.
Multi-Function	Allowing users to select any one of the following modes: Access Point, WDS AP, WDS Bridge, and Repeater depending on their specific networking deployment need.
Support Multiple SSID in AP mode (up to 8 in each frequency band)	Allow clients to access different networks through a single access point and assign different policies and functions for each SSID through the built in software.
WPA/WPA2/IEEE 802.1x Support	Powerful data security.
MAC Address Filtering in AP Mode	For more secure network connections with known users and devices.
User Isolation Support (AP mode)	Offers an additional layer of protection within the network by isolating specific client users.
Power-over-Ethernet (IEEE802.3at/af)	Allows installers to deploy the access point in locations via a PoE connection (Ethernet cable) where a power outlet may not be available.
Save User Settings	Enables network administrators to save their device settings so firmware upgrades do not permanently delete previous device settings.
SNMP Remote Configuration Management	Allows remote connection to configure or manage the EAP600 easily.
QoS (WMM) support	Prioritizes bandwidth-intensive and sensitive data traffic.

1.2 Package Contents

The EAP600 package contains the following items (all items must be in package to issue a refund):

- EAP600 Access Point

- 12V/2A 100V~240V Power Adapter
- RJ-45 Ethernet LAN Cable
- Wall Mount Kit: Mounting Bracket, Wall/Ceiling Mounting Hardware Kit, T-Rail Mounting Hardware Kit
- CD with User's Manual
- Quick Installation Guide

1.3 System Requirements

The following are the Minimum System Requirements in order to configure the device.

- Computer with an Ethernet interface or wireless network capability
- Windows OS (XP, Vista, 7), Mac OS, or Linux-based operating systems
- Web-Browsing Application (i.e.: Internet Explorer, Firefox, Safari, or another similar browser application)

1.4 Applications

Wireless LAN (WLAN) products are easy to install and highly efficient. The following list describes some of the many applications made possible through the power and flexibility of WLANs:

a) Difficult-to-Wire Environments

There are many situations where wires cannot be installed or deployed easily or cannot be hidden from view. Older buildings, sites with multiple buildings, and/or areas make the installation of an Ethernet-based LAN impossible, impractical or expensive.

b) Temporary Workgroups

Create temporary workgroups/networks in more open areas within a building – auditoriums, amphitheater classrooms, ballrooms, arenas, exhibition centers, temporary offices where one wants either a permanent or temporary Wireless LAN established.

c) The Ability to Access Real-Time Information

Doctors/Nurses, Point-of-Sale Employees, and/or Warehouse Workers can access real-time information while dealing with patients, serving customers, and/or processing information.

d) Frequently Changing Environments

Set up networks in environments that change frequently (i.e.: Show Rooms, Exhibits, etc.).

e) Small Office and Home Office (SOHO) Networks

SOHO users need a cost-effective, easy and quick installation of a small network.

f) Wireless Extensions to Existing Ethernet-based Networks

Devices like the EAP600 enable network administrators, installers and end-users to extend the range and reach of an existing Ethernet-based network.

g) Training/Educational Facilities

Training sites at corporations or students at universities use wireless connectivity to ease access to information, information exchanges, and learning.

2 Before you Begin

This section will guide you through the installation process. Placement of the EnGenius EAP600 is essential to maximize the access point's performance. Avoid placing the EAP600 in an enclosed space such as a closet, cabinet, or stairwell.

2.1 Considerations for Wireless Installation

The operating distance of all wireless devices cannot be pre-determined due to a number of unknown obstacles in the environment that the device is deployed in. These could be the number, thickness, and location of walls, ceilings, or other objects that the EAP600's wireless signals must pass through. Here are some key guidelines to allow the EAP600 to have optimal wireless range.

- Keep the number of walls and/or ceilings between the EAP600 and other network devices to a minimum. Each wall and/or ceiling can reduce the signal strength, resulting in lower signal strength.
- Building materials makes a difference. A solid metal door and/or aluminum studs may have a significant negative effect on the signal strength of the EAP600. Locate your wireless devices carefully so the signal can pass through a drywall and/or open doorways. Materials such as glass, steel, metal, concrete, water (example: fish tanks), mirrors, file cabinets and/or brick can also diminish wireless signal strength.
- Interference from your other electrical devices and/or appliances that generate RF noise can also diminish the EAP600's signal strength. The most common types of devices are microwaves or cordless phones.

2.2 Computer Settings (in Windows XP/Windows 7)

In order to use the EAP600, you must first configure the TCP/IPv4 connection of your Windows OS computer system.

- Click **Start** button and open **Control Panel**.



Windows XP

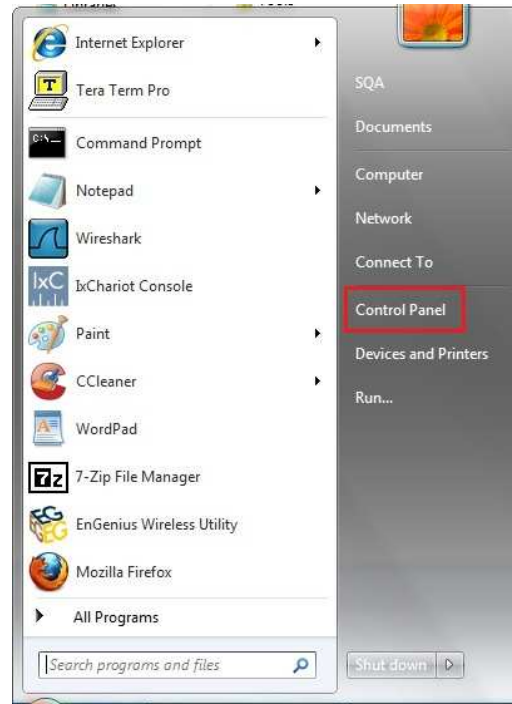

Windows 7

- In **Windows XP**, click **Network Connections**

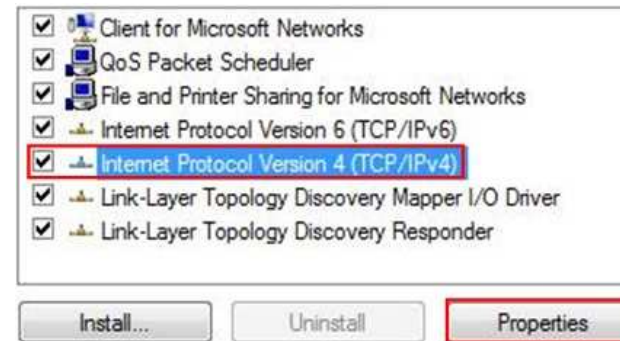

- In **Windows 7**, click **View Network Status and Tasks** in the **Network and Internet** section, then select **Change adapter settings**

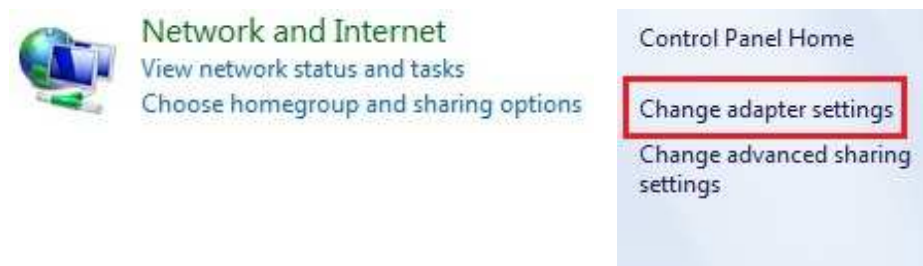

- Right click on **Local Area Connection** and select **Properties**

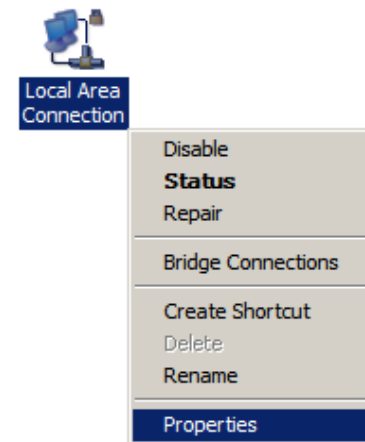

- Select "**Internet Protocol Version 4 (TCP/IPv4)**" and then select **Properties**

- Select **Use the following IP address** and enter an IP address that is different from the EAP600 and subnet mask then click **OK**.

Note: Ensure that the IP address and subnet mask are on the same subnet as the device.

For example: EAP600 IP address: 192.168.1.1
 PC IP address: 192.168.1.2 – 192.168.1.255
 PC subnet mask: 255.255.255.0

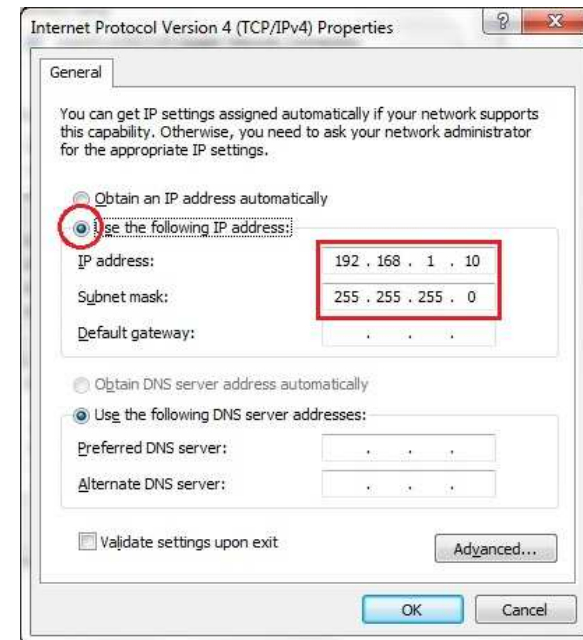

2.3 Computer Settings in Apple Mac OS X

- Go to **System Preferences** (can be opened in the **Applications** folder or selecting it in the Apple Menu)
- Select **Network** in the **Internet & Network** section
- Highlight **Ethernet**
- In **Configure IPv4**, select **Manually**
- Enter an IP address that is different from the EAP600 and subnet mask then press **OK**

Note: Ensure that the IP address and subnet mask are on the same subnet as the device.

For example: EAP600 IP address: 192.168.1.1

PC IP address: 192.168.1.2 – 192.168.1.255

PC subnet mask: 255.255.255.0

- Click **Apply** when done.

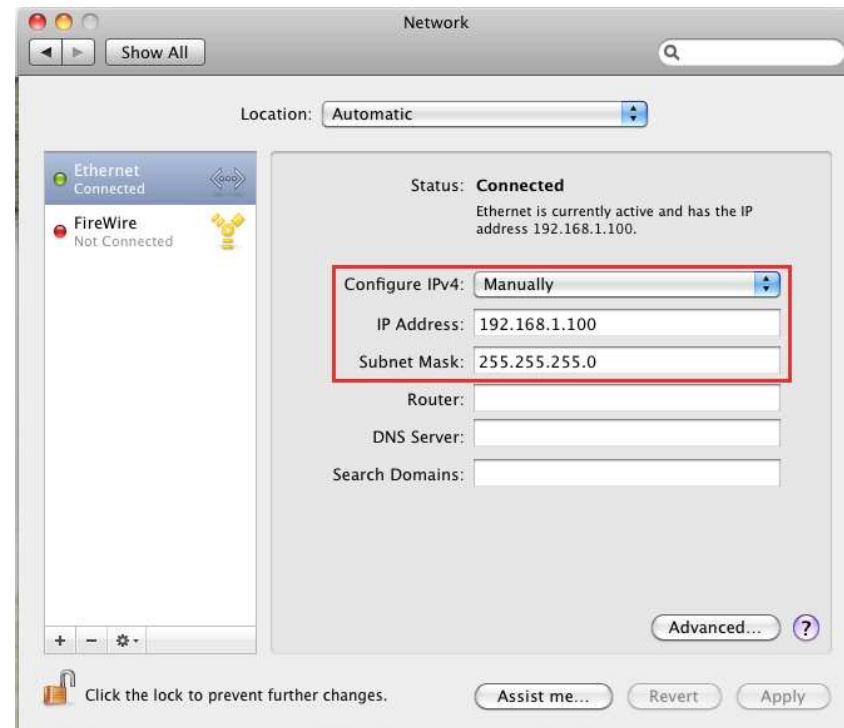

2.4 Hardware Installation

1. Ensure that the computer in use has an Ethernet Controller (RJ-45 Ethernet Port). For more information, verify with your computer's user manual.
2. Connect one end of the Category 5e Ethernet cable into the RJ-45 port of the EAP600 and the other end to the RJ-45 port of the computer. Ensure that the cable is securely connected to both the EAP600 and the computer.
3. Connect the Power Adapter DC connector to the DC-IN port of the EAP600 and the Power Adapter to an available electrical outlet. Once both connections are secure, verify the following:
 - a) Ensure that the **POWER** light is on (it will be orange).
 - b) Ensure that the **2.4GHz/5GHz WLAN** light is on (it will be green for 5G, blue for 2.4G).
 - c) Ensure that the **LAN (Computer/EAP600 Connection)** light is on (it will be blue).
 - d) Once all three lights are on, proceed to set up the access point using the computer.

This diagram depicts the hardware configuration.

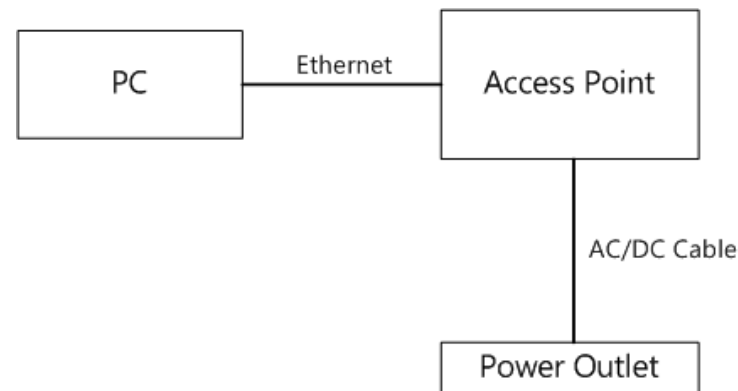

Mounting the EAP600

Using the provided hardware, the EAP600 can be attached to a ceiling or wall.

To attach the EAP600 to a ceiling or wall using the mounting bracket:

- 1) Attach the mounting bracket to the wall or ceiling using the provided wall/ceiling mounting hardware kit.
- 2) Insert the provided short screws into the bottom cover of the EAP600.

Leave enough of the screws exposed to ensure that the unit can be attached to the mounting bracket.

If extra space is required, use the provided spacers and long screws from the T-Rail mounting hardware kit to increase the space between the unit and the mounting bracket.

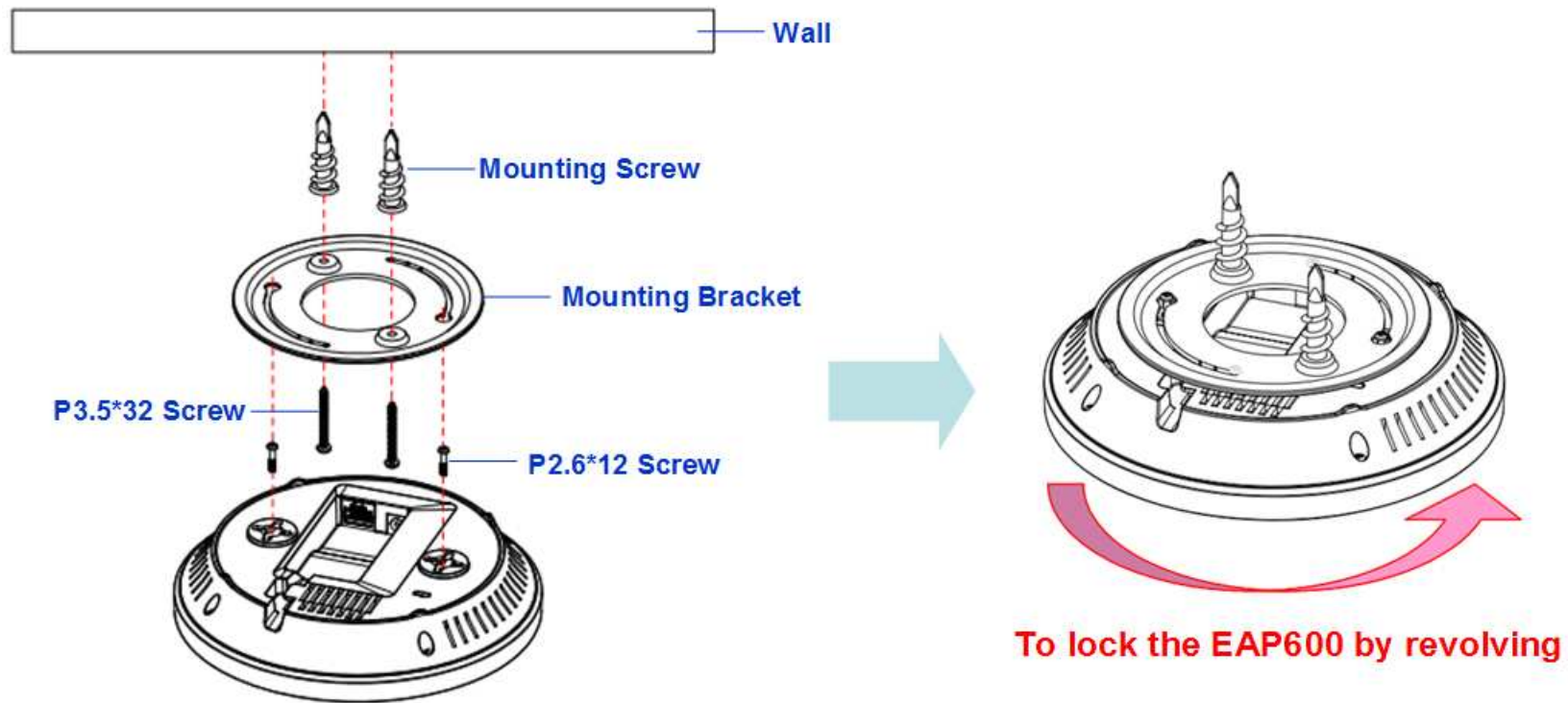

- 3) Mount the EAP600 on the mounting bracket by rotating the unit clockwise about 90 degrees to secure it in place.

To attach the EAP600 to a ceiling using the provided T-rail connectors:

- 1) Attach the T-rail connectors to the bottom cover of the EAP600 using the provided short screws. Two sizes of T-rail connectors are included in the mounting hardware kit: 15/16in (2.38cm) and 9/16in (1.43cm). If extra space is required to accommodate drop ceiling tiles, use the provided spacers and long screws.

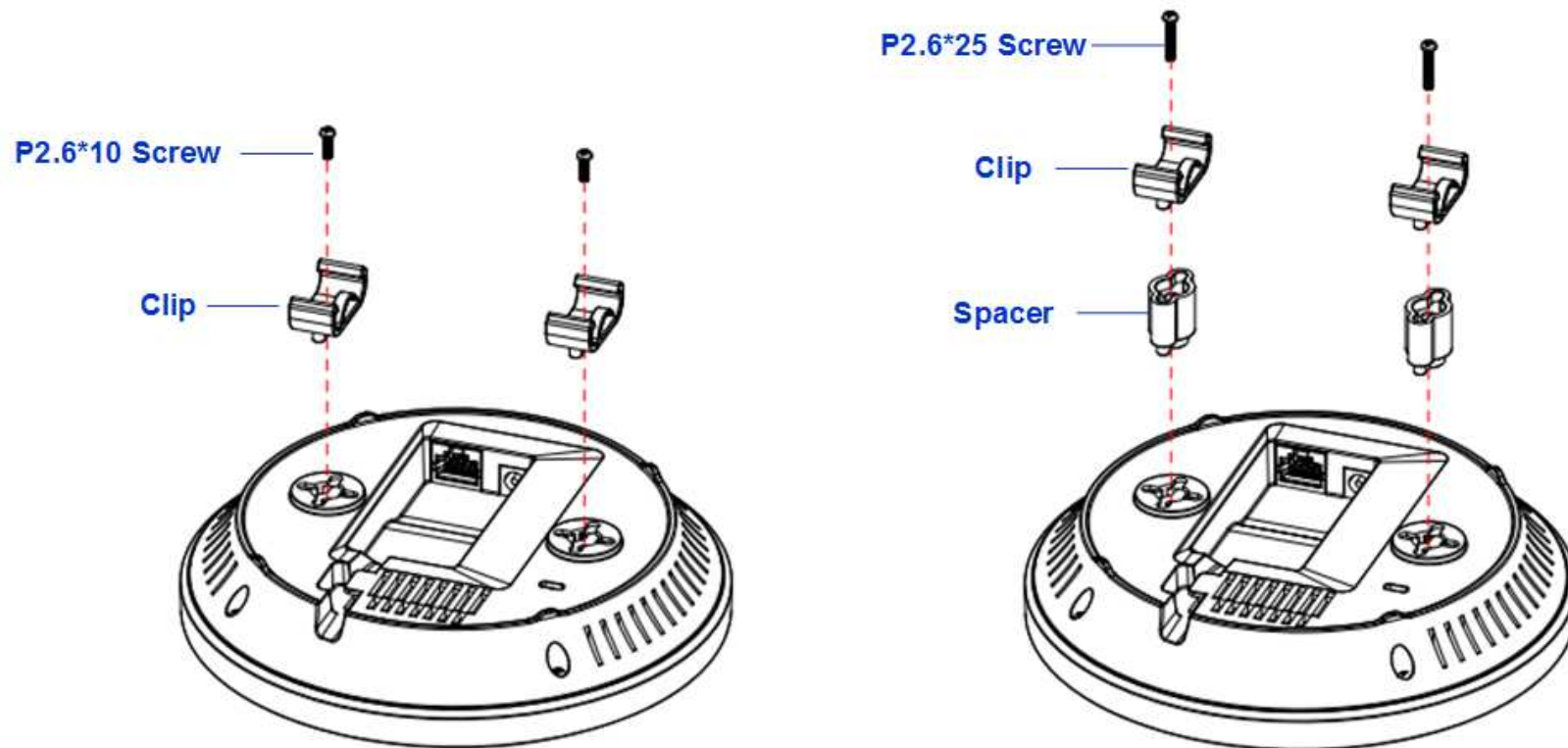

- 2) Line up the connected T-rail connectors with an appropriately sized rail and press the unit onto the rail until it snaps into place.

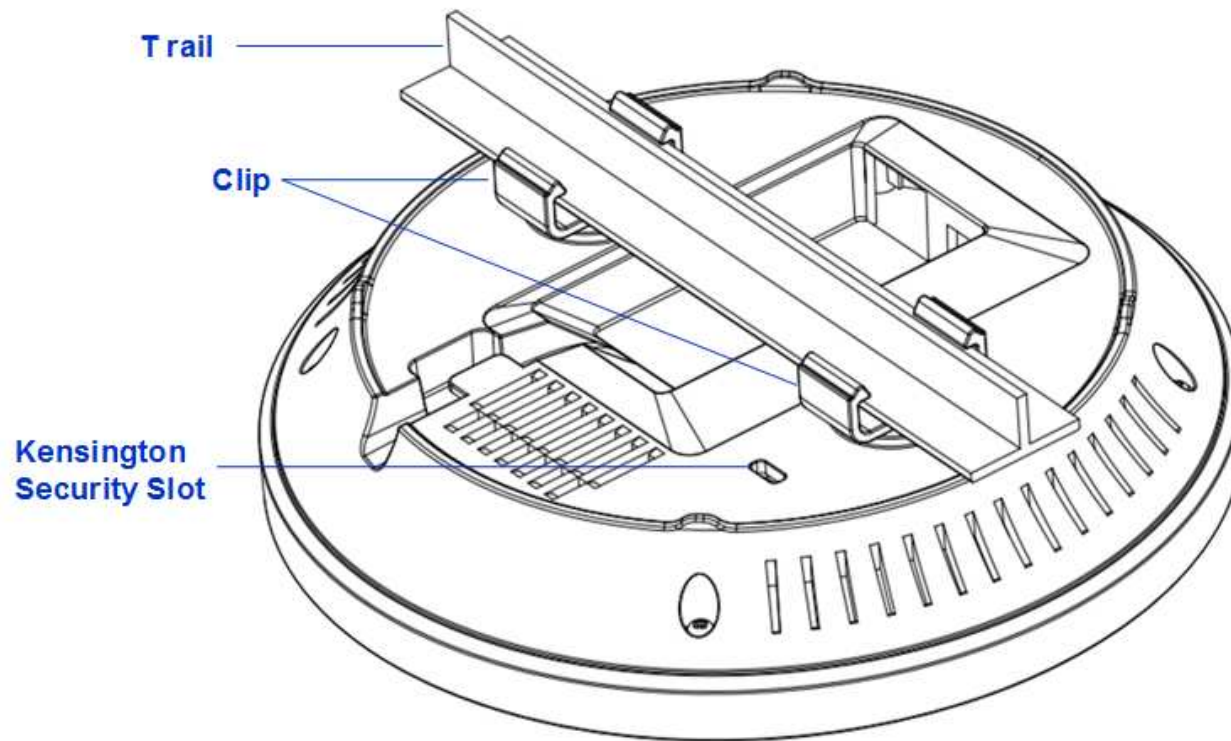

Note: To protect your EAP600, use the Kensington security slot to attach a cable lock (cable lock is not included).

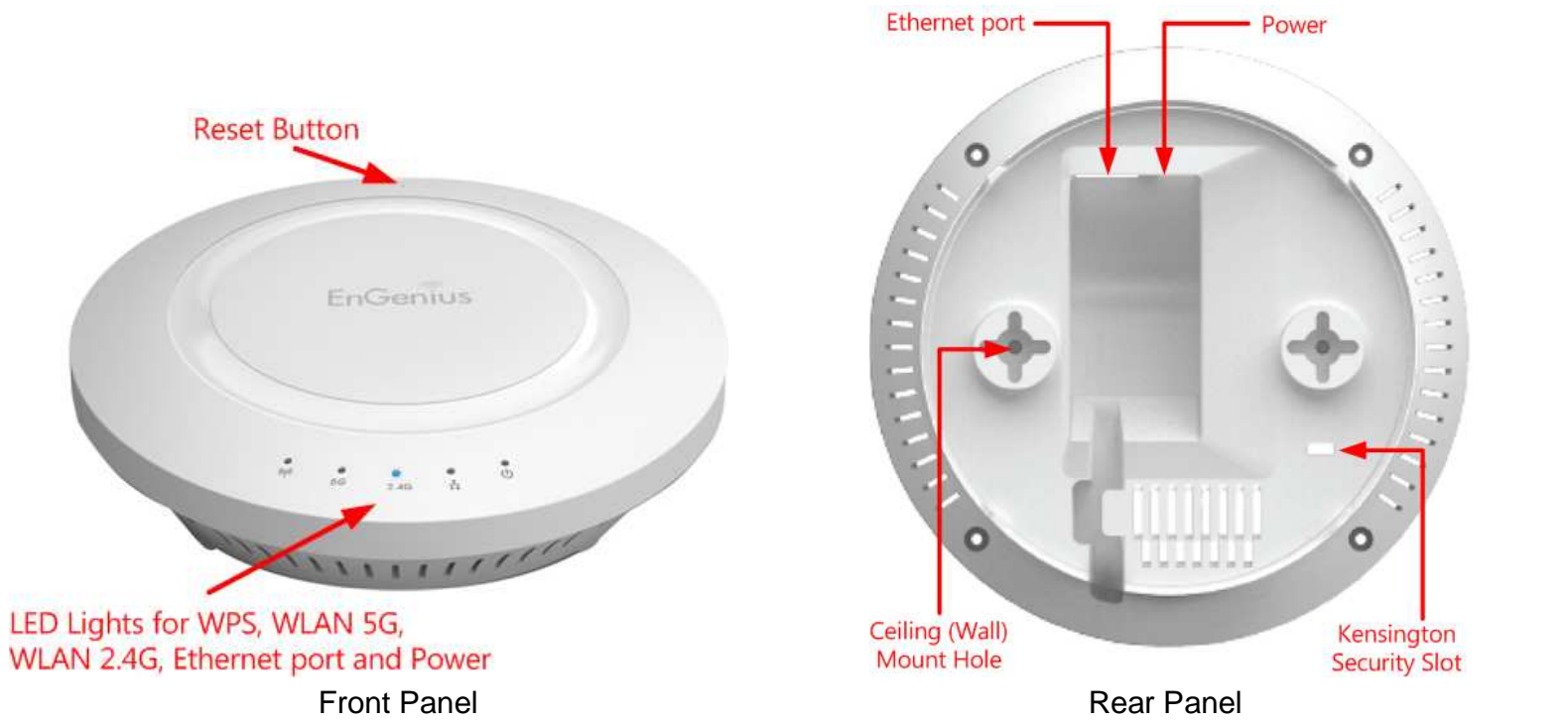

Front Panel	
Reset Button	One click for reset the device. Press over 10 seconds for reset to factory default.
LED Lights	LED lights for WPS, WLAN 5G, WLAN 2.4G, Ethernet port and Power.
Rear Panel	
Power	DC IN for Power.
Ethernet Port	Ethernet port for RJ-45 cable.
Ceiling (Wall) Mount Hole	Using the provided hardware, the EAP600 can be attached to a ceiling or wall.
Kensington Security Slot	To protect your EAP600, use the Kensington security slot to attach a cable lock.

3 Configuring Your Access Point

This section will show you how to configure the device using the web-based configuration interface.

3.1 Default Settings

Please use your Ethernet port or wireless network adapter to connect the Access Point.

Default Settings

IP Address	192.168.1.1
Username / Password	admin / admin
Operation Mode	AP / AP

3.2 Web Configuration

- Open a web browser (Internet Explorer/Firefox/Safari) and enter the IP Address **http://192.168.1.1**

Note: If you have changed the default LAN IP Address of the Access Point, ensure you enter the correct IP Address.



- The default username and password are **admin**. Once you have entered the correct username and password, click the **Login** button to open the web-base configuration page.

A screenshot of the EnGenius login page. The page title is "EnGenius". Below the title, there are two input fields: "Username: admin" and "Password: ●●●●". At the bottom of the form, there are two buttons: "Login" and "Reset".

- If successful, you will be logging in and see the EAP600 User Menu.

System Information

Device Name	EAP600
Ethernet MAC Address	00:02:6F:D7:AC:6C
2.4G Wireless MAC Address (SSID/MAC)	1 00:02:6F:D7:AC:6C
	2 N/A
	3 N/A
	4 N/A
	5 N/A
	6 N/A
	7 N/A
	8 N/A
5G Wireless MAC Address (SSID/MAC)	1 00:02:6F:D7:AC:6D
	2 N/A
	3 N/A
	4 N/A
	5 N/A
	6 N/A
	7 N/A
	8 N/A
Country	N/A
Current Time	Tue Jul 10 12:17:11 UTC 2012
Firmware Version	1.1.11
Management VLAN ID	Untagged

LAN Settings

IP Address	192.168.1.1
Subnet Mask	255.255.255.0
Default Gateway	192.168.1.1
Primary DNS	0.0.0.0
Secondary DNS	0.0.0.0
DHCP Client	Disabled
Spanning Tree Protocol	Disabled

Current 2.4G Wireless Settings

Operation Mode	Access Point
Wireless Mode	802.11 B/G/N Mixed
Channel Bandwidth	20-40 MHz
Frequency/Channel	2.437 GHz (Channel 6)

4 Building a Wireless Network

The EAP600 has the ability to operate in various modes. This chapter describes the operating modes of the EAP600.

4.1 Access Point Mode

In Access Point Mode, EAP600 behaves like a central connection for stations or clients that support IEEE 802.11a/b/g/n networks. The stations and clients must be configured to use the same SSID (Service Set Identifier) and security password to associate with the EAP600. The EAP600 supports up to eight SSIDs at the same time for secure access.



4.2 WDS AP Mode

The EAP600 also supports WDS AP mode. This operating mode allows wireless connections to the EAP600 using WDS technology. In this mode, configure the MAC addresses in both Access Points to enlarge the wireless area by enabling WDS Link settings. WDS supports four AP MAC addresses.



4.3 WDS Bridge Mode

In WDS Bridge Mode, the EAP600 can wirelessly connect different LANs by configuring the MAC address and security settings of each EAP600 device. Use this mode when two wired LANs located a small distance apart want to communicate with each other. The best solution is to use the EAP600 to wirelessly connect two wired LANs, as shown in the following figure.

WDS Bridge Mode can establish four WDS links, creating a star-like network.

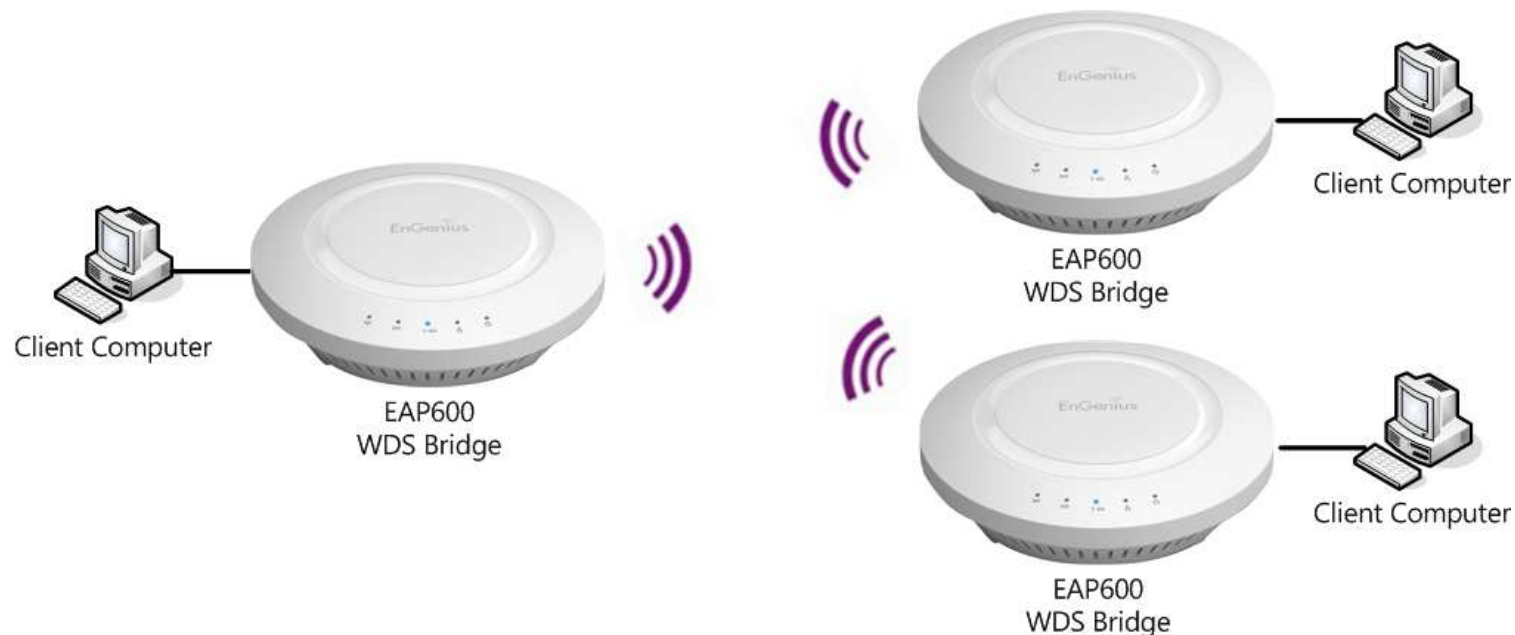

Note: WDS Bridge Mode does not act as an Access Point. Access Points linked by WDS are using the same frequency channel. More Access Points connected together may lower throughput. This configuration can be susceptible to generate endless network loops in your network, so it is recommended to enable the Spanning Tree function to prevent this from happening.

4.4 Repeater mode

The Repeater mode is used to regenerate or replicate signals from a wireless router or other access point/station that is unable to reach certain areas in a building. When this mode is activated in the EAP600, the EAP600 receives the wireless signal from an existing router or AP and relays it to other devices within its range so they can join the network.



5 Status

The **Status** section contains the following options: **Main**, **2.4G/5G Wireless Client List**, **2.4G/5G Connection Status**, **2.4G/5G WDS Link List** and **System Log**.

The following sections describe these options.

5.1 Save/Reload

This page lets you save and apply the settings shown under **Unsaved changes list**, or cancel the unsaved changes and revert them to the previous settings that were in effect.

Save/Reload

[Home](#)[Reset](#)

Unsaved changes list

```
wireless.cfg03378f.ssid=EnGenius
wireless.cfg03378f.encryption=psk2 aes
wireless.cfg03378f.key=12345678
wireless.cfg03378f.bssid=00:02:6F:10:10:14
wireless.cfg03378f.WDScompatibleMTEK=0
wireless.cfg03378f.PreferBSSIDEnable=0
wireless.wifi0.channel=1
```

[Save & Apply](#)[Revert](#)

5.2 Main

Clicking the **Main** link under the **Status** menu or clicking **Home** at the top-right of the EAP600 Page shows the status information about the current operating mode.

- The **System Information** section shows general system information such as Device Name, MAC Address, Current Time, Firmware Version, and Management VLAN ID (**Note:** VLAN ID is only applicable in Access Point or WDS AP mode).

System Information

Device Name	EAP600
Ethernet MAC Address	00:02:6F:D7:AC:6C
2.4G Wireless MAC Address (SSID/MAC)	1 00:02:6F:D7:AC:6C
	2 N/A
	3 N/A
	4 N/A
	5 N/A
	6 N/A
	7 N/A
	8 N/A
5G Wireless MAC Address (SSID/MAC)	1 00:02:6F:D7:AC:6D
	2 N/A
	3 N/A
	4 N/A
	5 N/A
	6 N/A
	7 N/A
	8 N/A
Current Time	Thu May 17 15:09:01 UTC 2012
Firmware Version	1.1.7
Management VLAN ID	Untagged

- The **LAN Settings** section shows the Local Area Network settings such as the LAN IP Address, Subnet Mask, and DNS Address.

LAN Settings

IP Address	192.168.1.1
Subnet Mask	255.255.255.0
Default Gateway	192.168.1.1
Primary DNS	0.0.0.0
Secondary DNS	0.0.0.0
DHCP Client	Disabled
Spanning Tree Protocol	Disabled

- The **Current 2.4G/5G Wireless Settings** section shows wireless information such as Operating Mode, Frequency, and Channel. Since the EAP600 supports multiple-SSIDs, information about each SSID, the ESSID and security settings, are displayed (**Note:** Profile Settings is only applicable in Access Point, WDS AP).

Current 2.4G Wireless Settings

Operation Mode	Access Point
Wireless Mode	802.11 B/G/N Mixed
Channel Bandwidth	20-40 MHz
Frequency/Channel	2.412 GHz (Channel 1)
Profile Settings (SSID/Security/VID/802.1Q)	1 EnGeniusD7AC6C-2.4G/None/1/OFF
	2 N/A
	3 N/A
	4 N/A
	5 N/A
	6 N/A
	7 N/A
	8 N/A
Distance	1 Km

Current 5G Wireless Settings

Operation Mode	Access Point
Wireless Mode	802.11 A/N Mixed
Channel Bandwidth	20-40 MHz
Frequency/Channel	5.18 GHz (Channel 36)
Profile Settings (SSID/Security/VID/802.1Q)	1 EnGeniusD7AC6D-5G/None/51/OFF
	2 N/A
	3 N/A
	4 N/A
	5 N/A
	6 N/A
	7 N/A
	8 N/A
Distance	1 Km

5.3 2.4G/5G Wireless Client List

Clicking the **2.4G/5G Wireless Client List** link under the **Status** menu displays the list of clients associated to the EAP600's 2.4GHz/5GHz, along with the MAC addresses and signal strength for each client. Clicking **Refresh** updates the client list.

Note: Only applicable in Access Point, WDS AP, and Repeater mode.

2.4G / Client List

[Home](#)[Reset](#)

SSID:#	MAC Address	RSSI(dBm)
SSID1:#1	00:02:6f:4d:f2:1e	-23
SSID1:#2	00:02:6f:11:ac:93	-31

[Refresh](#)

5G / Client List

[Home](#)[Reset](#)

SSID:#	MAC Address	RSSI(dBm)
SSID51:#1	00:02:6f:63:69:19	-38

[Refresh](#)

5.4 2.4G/5G Connection Status

Click on the **2.4G/5G Connection Status** link under the **Status** menu. This page displays the current status of the Network, including Network Type, SSID, BSSID, Connection Status, Wireless Mode, Current Channel, Security, Data Rate, Noise Level, and Signal Strength.

Note: Only applicable in Repeater mode.

2.4G / Connection Status

[Home](#)
[Reset](#)

Network Type	Repeater
SSID	EnGenius
BSSID	00:02:6F:C7:EB:70
Connection Status	Associated
Wireless Mode	IEEE 802.11b/g/n Mixed
Current Channel	2.412 GHz(Channel 1)
Security	WPA2-PSK AES
Tx Data Rates(Mbps)	300 Mbps
Current noise level	-95 dBm
Signal strength	-52 dBm

5G / Connection Status

[Home](#)
[Reset](#)

Network Type	Repeater
SSID	EnGenius
BSSID	00:02:6F:C7:EB:74
Connection Status	Associated
Wireless Mode	IEEE 802.11n/a Mixed
Current Channel	5.745 GHz(Channel 149)
Security	WPA2-PSK AES
Tx Data Rates(Mbps)	300 Mbps
Current noise level	-95 dBm
Signal strength	-34 dBm

5.5 2.4G/5G WDS Link List

Click on the **2.4G/5G WDS Link List** link under the **Status** menu. This page displays the current status of the WDS link, including WDS Link ID, MAC Address, Link Status and RSSI.

Note: Only applicable in WDS AP and WDS Bridge mode.

2.4G / WDS Link List

[Home](#)[Reset](#)

WDS Link ID	MAC Address	Link Status	RSSI (dBm)
1	00:02:6f:ca:e6:be	UP	-96

[Refresh](#)

5G / WDS Link List

[Home](#)[Reset](#)

WDS Link ID	MAC Address	Link Status	RSSI (dBm)
1	00:02:6f:11:22:33	DOWN	--

[Refresh](#)

5.6 System Log

The EAP600 automatically logs (records) events of possible interest in its internal memory. To view the logged information, click the **System Log** link under the **Status** menu. If there is not enough internal memory to log all events, older events are deleted from the log. When powered down or rebooted, the log will be cleared.

Home
Reset

Show log type
All

```

May 17 16:10:03 EAP600 user.notice root: starting ntpclient
May 17 16:10:01 EAP600 cron.err crond[1107]: USER root pid 487 cmd . /etc/hotplug.d/iface/20-ntpcli
May 17 16:05:03 EAP600 user.notice root: starting ntpclient
May 17 16:05:01 EAP600 cron.err crond[1107]: USER root pid 472 cmd . /etc/hotplug.d/iface/20-ntpcli
May 17 16:00:03 EAP600 user.notice root: starting ntpclient
May 17 16:00:01 EAP600 cron.err crond[1107]: USER root pid 457 cmd . /etc/hotplug.d/iface/20-ntpcli
May 17 15:55:04 EAP600 user.notice root: starting ntpclient
May 17 15:55:02 EAP600 cron.err crond[1107]: USER root pid 442 cmd . /etc/hotplug.d/iface/20-ntpcli
May 17 15:50:04 EAP600 user.notice root: starting ntpclient
May 17 15:50:01 EAP600 cron.err crond[1107]: USER root pid 3561 cmd . /etc/hotplug.d/iface/20-ntpcli
May 17 15:45:03 EAP600 user.notice root: starting ntpclient
May 17 15:45:01 EAP600 cron.err crond[1107]: USER root pid 2691 cmd . /etc/hotplug.d/iface/20-ntpcli
May 17 15:40:03 EAP600 user.notice root: starting ntpclient
May 17 15:40:01 EAP600 cron.err crond[1107]: USER root pid 2040 cmd . /etc/hotplug.d/iface/20-ntpcli
May 17 15:35:03 EAP600 user.notice root: starting ntpclient
May 17 15:35:01 EAP600 cron.err crond[1107]: USER root pid 1818 cmd . /etc/hotplug.d/iface/20-ntpcli
May 17 15:30:03 EAP600 user.notice root: starting ntpclient
May 17 15:30:01 EAP600 cron.err crond[1107]: USER root pid 1803 cmd . /etc/hotplug.d/iface/20-ntpcli
May 17 15:25:03 EAP600 user.notice root: starting ntpclient
May 17 15:25:01 EAP600 cron.err crond[1107]: USER root pid 1788 cmd . /etc/hotplug.d/iface/20-ntpcli
May 17 15:20:03 EAP600 user.notice root: starting ntpclient
May 17 15:20:01 EAP600 cron.err crond[1107]: USER root pid 1773 cmd . /etc/hotplug.d/iface/20-ntpcli

```

Refresh
Clear

System Log	
Refresh	Update the log.
Clear	Clear the log.

6 System

6.1 Operation Mode

The EAP600 supports four operating modes: Access Point, WDS AP, WDS Bridge, and Repeater.

System Properties

[Home](#)
[Reset](#)

System Properties

Device Name	EAP600 (1 to 32 characters)
Operation Mode	2.4G Wireless Configuration <input checked="" type="radio"/> Access Point <input type="radio"/> WDS <input type="radio"/> Repeater 5G Wireless Configuration <input checked="" type="radio"/> Access Point <input type="radio"/> WDS <input type="radio"/> Repeater

[Accept](#)
[Cancel](#)

System Properties

Device Name	Enter a name for the device. The name you type appears in SNMP management. This name is not the SSID and is not broadcast to other devices.
Operation Mode	Use the radio button to select an operating mode.
Save & Apply / Cancel	Click Save & Apply to confirm the changes or Cancel to cancel and return previous settings.

6.2 IP Settings

This page allows you to modify the device's IP settings.

IP Settings

[Home](#)
[Reset](#)

System Information

IP Network Setting	<input type="radio"/> Obtain an IP address automatically (DHCP) <input checked="" type="radio"/> Specify an IP address
IP Address	192 . 168 . 1 . 1
IP Subnet Mask	255 . 255 . 255 . 0
Default Gateway	192 . 168 . 1 . 1
Primary DNS	0 . 0 . 0 . 0
Secondary DNS	0 . 0 . 0 . 0

[Accept](#)
[Cancel](#)

IP Settings	
IP Network Setting	Select whether the device IP address will use the static IP address specified in the IP Address field or be obtained automatically when the device connects to a DHCP server.
IP Address	The IP Address of this device.
IP Subnet Mask	The IP Subnet Mask of this device.
Default Gateway	The Default Gateway of this device. Leave it blank if you are unsure of this setting.
Primary / Secondary DNS	The primary / secondary DNS address for this device.

6.3 Spanning Tree Setting

This page allows you to modify the Spanning Tree settings. Enabling Spanning Tree protocol will prevent network loops in your LAN network.

Spanning Tree Settings

[Home](#)
[Reset](#)

Spanning Tree Status	<input type="radio"/> On <input checked="" type="radio"/> Off
Bridge Hello Time	2 seconds (1-10)
Bridge Max Age	20 seconds (6-40)
Bridge Forward Delay	4 seconds (4-30)
Priority	32768 (0-65535)

[Accept](#)
[Cancel](#)

Spanning Tree	
Spanning Tree Status	Enable or disable the Spanning Tree function.
Bridge Hello Time	Specify Bridge Hello Time, in seconds. This value determines how often the device sends handshake packets to communicate information about the topology throughout the entire Bridged Local Area Network.
Bridge Max Age	Specify Bridge Max Age, in seconds. If another bridge in the spanning tree does not send a hello packet for a long period of time, it is assumed to be dead.
Bridge Forward Delay	Specify Bridge Forward Delay, in seconds. Forwarding delay time is the time spent in each of the Listening and Learning states before the Forwarding state is entered. This delay is provided so that when a new bridge comes onto a busy network, it analyzes data traffic before participating.
Priority	Specify the Priority Number. A smaller number has greater priority.

Accept / CancelClick **Accept** to confirm the changes or **Cancel** to cancel and return previous settings.

7 2.4G/5G Wireless

7.1 Wireless Network

This page displays the current status of the Wireless settings of the EAP600.

Access Point / WDS AP mode:

2.4G / Wireless Network

Home

Reset

Wireless Mode	802.11 B/G/N Mixed ▾
Channel HT Mode	20/40MHz ▾
Extension Channel	Upper Channel ▾
Channel / Frequency	Ch1-2.412GHz ▾ <input checked="" type="checkbox"/> Auto
AP Detection	Scan

Current Profiles				
SSID	Security	VID	Enable	Edit
EnGeniusD7AC6C-2.4G	None	1	<input checked="" type="checkbox"/>	Edit
EnGeniusD7AC6C_2-2.4G	None	2	<input type="checkbox"/>	Edit
EnGeniusD7AC6C_3-2.4G	None	3	<input type="checkbox"/>	Edit
EnGeniusD7AC6C_4-2.4G	None	4	<input type="checkbox"/>	Edit
EnGeniusD7AC6C_5-2.4G	None	5	<input type="checkbox"/>	Edit
EnGeniusD7AC6C_6-2.4G	None	6	<input type="checkbox"/>	Edit
EnGeniusD7AC6C_7-2.4G	None	7	<input type="checkbox"/>	Edit
EnGeniusD7AC6C_8-2.4G	None	8	<input type="checkbox"/>	Edit

Accept

Cancel

5G / Wireless Network

[Home](#) [Reset](#)

Wireless Mode	802.11 A/N Mixed ▾
Channel HT Mode	20/40MHz ▾
Extension Channel	Upper Channel ▾
Channel / Frequency	Ch36-5180GHz ▾ <input checked="" type="checkbox"/> Auto
AP Detection	<input type="button" value="Scan"/>

Current Profiles				
SSID	Security	VID	Enable	Edit
EnGeniusD7AC6D-5G	None	51	<input checked="" type="checkbox"/>	<input type="button" value="Edit"/>
EnGeniusD7AC6D_2-5G	None	52	<input type="checkbox"/>	<input type="button" value="Edit"/>
EnGeniusD7AC6D_3-5G	None	53	<input type="checkbox"/>	<input type="button" value="Edit"/>
EnGeniusD7AC6D_4-5G	None	54	<input type="checkbox"/>	<input type="button" value="Edit"/>
EnGeniusD7AC6D_5-5G	None	55	<input type="checkbox"/>	<input type="button" value="Edit"/>
EnGeniusD7AC6D_6-5G	None	56	<input type="checkbox"/>	<input type="button" value="Edit"/>
EnGeniusD7AC6D_7-5G	None	57	<input type="checkbox"/>	<input type="button" value="Edit"/>
EnGeniusD7AC6D_8-5G	None	58	<input type="checkbox"/>	<input type="button" value="Edit"/>

2.4G/5G Wireless Network (Access Point / WDS AP mode)	
Wireless Mode	Wireless mode supports 802.11b/g/n mixed mode in 2.4G and 802.11a/n mixed mode in 5G.
Channel HT Mode	The default channel bandwidth is 20/40MHz. The larger the channel, the better the transmission quality and speed.
Extension Channel	Select upper or lower channel. Your selection may affect the Auto channel function.
Channel / Frequency	Select the channel and frequency appropriate for your country's regulation.
Auto	Check this option to enable auto-channel selection.

AP Detection	AP Detection can select the best channel to use by scanning nearby areas for Access Points.
Current Profile	Configure up to eight different SSIDs (four in WDS AP mode). If many client devices will be accessing the network, you can arrange the devices into SSID groups. Click Edit to configure the profile and check whether you want to enable extra SSID.
Accept / Cancel	Click Accept to confirm the changes or Cancel to cancel and return previous settings.

2.4G/5G SSID Profile

2.4G / SSID Profile

Wireless Setting

SSID	EnGeniusD7AC6C-2.4G (1 to 32 characters)
Suppressed SSID	<input type="checkbox"/>
Station Separation	<input checked="" type="radio"/> Enable <input type="radio"/> Disable

Wireless Security

Security Mode	Disabled ▼
---------------	------------

5G / SSID Profile

Wireless Setting

SSID	EnGeniusD7AC6D-5G (1 to 32 characters)
Suppressed SSID	<input type="checkbox"/>
Station Separation	<input checked="" type="radio"/> Enable <input type="radio"/> Disable

Wireless Security

Security Mode	Disabled ▼
---------------	------------

2.4G/5G SSID Profile	
SSID	Specify the SSID for the current profile.
Suppressed SSID	Check this option to hide the SSID from clients. If checked, the SSID will not appear in the site survey.
Station Separation	Click the appropriate radio button to allow or prevent communication between client devices.
Wireless Security	See the Wireless Security section.
Save / Cancel	Click Save to accept the changes or Cancel to cancel and return previous settings.

Repeater mode:

2.4G / Wireless Network

Home Reset

Wireless Mode	802.11 B/G/N Mixed ▾
SSID	Specify the static SSID : AP SSID <input type="text"/> (1 to 32 characters) Or press the button to search for any available WLAN Service. <input type="button" value="Site Survey"/>
Prefered BSSID	<input type="checkbox"/> <input type="text"/> : <input type="text"/> : <input type="text"/> : <input type="text"/> : <input type="text"/> : <input type="text"/>

Wireless Security

Changing the wireless security settings may cause this wireless client to associate with a different one. This may temporarily disrupt your configuration session.

Security Mode	Disabled ▾
---------------	------------

Accept Cancel

5G / Wireless Network

Home Reset

Wireless Mode	802.11 A/N Mixed ▾
SSID	Specify the static SSID : AP SSID <input type="text"/> (1 to 32 characters) Or press the button to search for any available WLAN Service. <input type="button" value="Site Survey"/>
Prefered BSSID	<input type="checkbox"/> <input type="text"/> : <input type="text"/> : <input type="text"/> : <input type="text"/> : <input type="text"/> : <input type="text"/>

Wireless Security

Changing the wireless security settings may cause this wireless client to associate with a different one. This may temporarily disrupt your configuration session.

Security Mode	Disabled ▾
---------------	------------

Accept Cancel

2.4G/5G Wireless Network (Repeater mode)	
Wireless Mode	Wireless mode supports 802.11b/g/n mixed mode in 2.4G and 802.11a/n mixed mode in 5G.
SSID	The SSID is a unique named shared amongst all the points of the wireless network. The SSID must be identical on all points of the wireless network and cannot exceed 32 characters. You may specify an SSID or select one from the Site Survey .
Site Survey	Click on Site Survey to search the existing Access Points.
Preferred BSSID	Specify the BSSID (Access Point's MAC Address).
Wireless Security	The encryption is using. It must be the same as Access Point's encryption.
Accept / Cancel	Click Accept to confirm the changes or Cancel to cancel and return previous settings.

7.2 Wireless Security

The Wireless Security section lets you configure the EAP600's security modes: WEP, WPA-PSK, WPA2-PSK, WPA-PSK Mixed, WPA, WPA2, and WPA Mixed. It is strongly recommend to use WPA2-PSK.

WEP Encryption:

Wireless Security	
Security Mode	WEP ▾
Auth Type	Open System ▾
Input Type	Hex ▾
Key Length	40/64-bit (10 hex digits or 5 ASCII char) ▾
Default Key	1 ▾
Key1	1234567890
Key2	
Key3	
Key4	

WEP Encryption	
Auth Type	Select Open System or Shared Key .
Input type	ASCII : Regular Text (recommended) HEX : Hexadecimal Numbers (For advanced users)
Key Length	Select the desired option and ensure the wireless clients use the same setting. Choices are 64, 128, 152-bit password lengths.
Default Key	Select the key you wish to be default. Transmitted data is ALWAYS encrypted using the Default Key; the other Keys are for decryption only. You must enter a Key Value for the Default Key .
Encryption Key #	Enter the key value or values you wish to use. Only the Key selected as Default is required. The

	others are optional.
--	----------------------

WPA-PSK (WPA Pre-Shared Key) Encryption:

Wireless Security

Security Mode	WPA-PSK Mixed ▾
Encryption	Both(TKIP+AES) ▾
Passphrase	12345678 (8 to 63 characters) or (64 Hexadecimal characters)
Group Key Update Interval	3600 seconds(30~3600, 0: disabled)

WPA-PSK (WPA Pre-Shared Key) Encryption	
Encryption	Select the WPA encryption type you would like. Please ensure that your wireless clients use the same settings.
Passphrase	Wireless clients must use the same key to associate the device. If using ASCII format, the Key must be from 8 to 63 characters in length. If using HEXformat, the Key must be 64 HEX characters in length.
Group Key Update Interval	Specify how often, in seconds, the group key changes.

WPA Encryption: Only in Access Point / WDS AP mode

Wireless Security

Security Mode	WPA Mixed ▾
Encryption	Both(TKIP+AES) ▾
Radius Server	<input type="text"/> . <input type="text"/> . <input type="text"/> . <input type="text"/>
Radius Port	1812 <input type="text"/>
Radius Secret	<input type="text"/>
Group Key Update Interval	3600 <input type="text"/> seconds(30~3600, 0: disabled)
Radius Accounting	Enable ▾
Radius Accounting Server	<input type="text"/> . <input type="text"/> . <input type="text"/> . <input type="text"/>
Radius Accounting Port	1813 <input type="text"/>
Radius Accounting Secret	<input type="text"/>
Interim Accounting Interval	600 <input type="text"/> seconds(60~600)

WPA Encryption	
Encryption	Select the WPA encryption type you would like. Please ensure that your wireless clients use the same settings.
Radius Server	Enter the IP address of the Radius server.
Radius Port	Enter the port number used for connections to the Radius server.
Radius Secret	Enter the secret required to connect to the Radius server.
Group Key Update Interval	Specify how often, in seconds, the group key changes.
Radius Accounting	Enable or disable accounting feature.
Radius Accounting Server	Enter the IP address of the Radius accounting server.
Radius Accounting Port	Enter the port number used for connections to the Radius accounting server.
Radius Accounting Secret	Enter the secret required to connect to the Radius accounting server.

Interim Accounting Interval	Specify how often, in seconds, the accounting data sends.
------------------------------------	---

Note: 802.11n does not allow WEP/WPA-PSK TKIP/WPA2-PSK TKIP security mode. The connection mode will automatically change from 802.11n to 802.11g.

7.3 Site Survey

Use this feature to scan nearby Access Points.

Note: Only applicable in Repeater mode.

1. Click **Site Survey**.

Wireless Network

[Home](#)[Reset](#)

Wireless Mode	802.11 B/G/N Mixed ▾
SSID	Specify the static SSID : AP SSID <input type="text"/> (1 to 32 characters) Or press the button to search for any available WLAN Service. <input type="button" value="Site Survey"/>
Preferred BSSID	<input type="checkbox"/> <input type="text"/> : <input type="text"/> : <input type="text"/> : <input type="text"/> : <input type="text"/> : <input type="text"/>

Wireless Security

Changing the wireless security settings may cause this wireless client to associate with a different one. This may temporarily disrupt your configuration session.

Security Mode	Disabled ▾
---------------	------------

2. Scanning the nearby Access Points

Scanning

Please wait...

3. The EAP600 will list the available access points after site survey.

Site Survey

2GHz Site Survey

:Infrastructure :Ad_hoc

BSSID	SSID	Channel	Signal Level	Type	Security	Mode
00:02:6F:B9:3A:30	SQA-ADSL	1	-66 dBm	11g/n	WPA2-PSK	<input checked="" type="checkbox"/>
00:0C:F6:54:A9:79		6	-72 dBm	11g/n	WPA2-PSK	<input checked="" type="checkbox"/>
00:02:6F:9C:3D:84	EnGenius9C3D84	11	-85 dBm	11b/g	WPA-PSK	<input checked="" type="checkbox"/>
00:03:7F:BE:F2:25	ADDA_TEST	11	-84 dBm	11g/n	WPA/WPA2-PSK	<input checked="" type="checkbox"/>
00:03:7F:BE:F0:C0	EAP350- antennatesting	11	-52 dBm	11g/n	WPA2-PSK	<input checked="" type="checkbox"/>
00:02:6F:10:10:14	EnGenius	4	-38 dBm	11g/n	WPA2-PSK	<input checked="" type="checkbox"/>
00:02:6F:51:F9:38	EnGenius51F938	11	-79 dBm	11g/n	none	<input checked="" type="checkbox"/>
00:02:6F:B3:4F:38	SENAOWL	1	-83 dBm	11g/n	WEP	<input checked="" type="checkbox"/>
00:02:6F:6D:0B:EF	yenger	4	-83 dBm	11b/g	WEP	<input checked="" type="checkbox"/>
06:03:7F:BE:F1:1D	EnGenius2	6	-89 dBm	11g/n	none	<input checked="" type="checkbox"/>
00:1B:11:62:71:C3	dlink	2	-90 dBm	11g/n	none	<input checked="" type="checkbox"/>
00:40:05:C7:49:4C	default	6	-90 dBm	11b	none	<input checked="" type="checkbox"/>

Refresh

Site Survey (Repeater mode)

BSSID	Access Point's wireless MAC address.
SSID	SSID that the Access Point is broadcasting.
Channel	Channel that the Access Point is using.
Signal Level (dBm)	Signal strength from the Access Point to your station.
Type	The band that the Access Point is using.
Security	Encryption method that the Access Point is using to secure data over the WLAN.
Refresh	Click Refresh to rescan nearby Access Point.

4. Select an Access Point and click that Access Point's BSSID.

Site Survey

2GHz Site Survey

 Infrastructure  Ad_hoc

BSSID	SSID	Channel	Signal Level	Type	Security	Mode
00:02:6F:B9:3A:30	SQA-ADSL	1	-66 dBm	11g/n	WPA2-PSK	
00:0C:F6:54:A9:79		6	-72 dBm	11g/n	WPA2-PSK	
00:02:6F:9C:3D:84	EnGenius9C3D84	11	-85 dBm	11b/g	WPA-PSK	
00:03:7F:BE:F2:25	ADDA_TEST	11	-84 dBm	11g/n	WPA/WPA2-PSK	
00:03:7F:BE:F0:C0	EAP350- antennatesting	11	-52 dBm	11g/n	WPA2-PSK	
00:02:6F:10:10:14	EnGenius	4	-38 dBm	11g/n	WPA2-PSK	
00:02:6F:51:F9:38	EnGenius51F938	11	-79 dBm	11g/n	none	
00:02:6F:B3:4F:38	SENAOWL	1	-83 dBm	11g/n	WEP	
00:02:6F:6D:0B:EF	yenger	4	-83 dBm	11b/g	WEP	
06:03:7F:BE:F1:1D	EnGenius2	6	-89 dBm	11g/n	none	
00:1B:11:62:71:C3	dlink	2	-90 dBm	11g/n	none	
00:40:05:C7:49:4C	default	6	-90 dBm	11b	none	

Refresh

5. Enter the correct security setting.

Wireless Network

Home

Reset

Wireless Mode	802.11 B/G/N Mixed ▾
SSID	Specify the static SSID : EnGenius (1 to 32 characters) Or press the button to search for any available WLAN Service. <input type="button" value="Site Survey"/>
Preferred BSSID	<input type="checkbox"/> 00 : 02 : 6F : 10 : 10 : 14

Wireless Security

Changing the wireless security settings may cause this wireless client to associate with a different one. This may temporarily disrupt your configuration session.

Security Mode	WPA2-PSK ▾
Encryption	AES ▾
Passphrase	12345678 (8 to 63 characters) or (64 Hexadecimal characters)

7.4 Wireless MAC Filtering

Wireless MAC Filtering is used to allow or deny network access to wireless clients (computers, tablet PCs, NAS, smartphones, etc.) according to their MAC addresses. You can manually add a MAC address to restrict the permission to access EAP600. The default setting is **Disable Wireless MAC Filter**.

Note: Only applicable in Access Point and WDS AP mode.

2.4G / Wireless MAC Filter

[Home](#)
[Reset](#)

 ACL Mode
 : : : : :

#	MAC Address	
1	00:02:6F:30:9A:12	<input type="button" value="Delete"/>

5G / Wireless MAC Filter

[Home](#)
[Reset](#)

 ACL Mode
 : : : : :

#	MAC Address	
---	-------------	--

Wireless MAC Filter (Access Point / WDS AP mode)

ACL Mode	Determines whether network access is granted or denied to clients whose MAC addresses appear in the MAC Address table on this page. Choices are: Disabled , Deny MAC in the list , or Allow MAC in the list .
MAC Address	Enter the MAC address of the wireless client.
Add	Click Add to add the MAC address to the MAC Address table.
Delete	Delete the selected entries.
Apply	Click Apply to apply the changes.

7.5 Wireless Advanced

This page allows you to configure wireless advance settings. It is recommended that the default settings are used unless the user has experience with more advanced networking features.

2.4G / Wireless Advanced Settings

[Home](#)
[Reset](#)

Data Rate	Auto ▾
RTS/CTS Threshold (1 - 2346)	2346 bytes
Distance (1-30km)	1 km
Aggregation:	<input checked="" type="radio"/> Enable <input type="radio"/> Disable 32 Frames 50000 Bytes(Max)

[Accept](#)
[Cancel](#)

5G / Wireless Advanced Settings

[Home](#)
[Reset](#)

Data Rate	Auto ▾
RTS/CTS Threshold (1 - 2346)	2346 bytes
Distance (1-30km)	1 km
Aggregation:	<input checked="" type="radio"/> Enable <input type="radio"/> Disable 32 Frames 50000 Bytes(Max)

[Accept](#)
[Cancel](#)

2.4G/5G Wireless Advanced

Data Rate	Select a data rate from the drop-down list. The data rate affects throughput of data in the EAP600. The lower the data rate, the throughput will be lower, but so will the transmission distance.
RTS/CTS Threshold	Specify the threshold package size for RTC/CTS. A small number causes RTS/CTS packets to be sent more often and consumes more bandwidth.
Distance	Specify the distance between Access Points and clients. Longer distances may drop high-speed connections.
Aggregation	Merges data packets into one packet. This option reduces the number of packets, but increases packet sizes.
Accept / Cancel	Click Accept to confirm the changes or Cancel to cancel and return previous settings.

7.6 WPS (Wi-Fi Protected Setup)

Wi-Fi Protected Setup (WPS) feature complies with the Wi-Fi Alliance WPS standard and makes it easier to quickly add client devices to an established, security-enabled Wi-Fi network.

WPS reduces the user steps required to configure a network and supports two methods that are familiar to most consumers to configure a network and enable security.

Note: Only applicable in Access Point and WDS AP mode.

2.4G / WPS Setting
Home
Reset

WPS	<input checked="" type="radio"/> Enable <input type="radio"/> Disable
WPS current status	Configured Release Configuration
Self Pin Code	43384990
SSID	EnGeniusD7AC6C-2.4G
Authentication Mode	WPA-PSK Mixed TKIP/AES
Passphrase Key	12345678
WPS Via Push Button	Start to Process
WPS Via Pin	<input type="text"/> Start to Process

Accept
Cancel

5G / WPS Setting

Home

Reset

WPS	<input checked="" type="radio"/> Enable <input type="radio"/> Disable
WPS current status	Configured <input type="button" value="Release Configuration"/>
Self Pin Code	43384990
SSID	EnGeniusD7AC6D-5G
Authentication Mode	WPA-PSK Mixed TKIP/AES
Passphrase Key	12345678
WPS Via Push Button	<input type="button" value="Start to Process"/>
WPS Via Pin	<input type="text"/> <input type="button" value="Start to Process"/>

Accept

Cancel

WPS (Wi-Fi Protected Setup)	
WPS	Select to Enable or Disable the WPS feature.
WPS Current Status	Shows whether the WPS function is Configured or unConfigured . When it is Configured, the WPS has been used to authorize connection between the device and wireless clients.
Self Pin Code	The PIN code of this device.
SSID	The SSID (wireless network name) used when connecting using WPS.
Authentication Mode	Shows the encryption method used by the WPS process.
Passphrase Key	This is the passphrase key that is randomly generated during the WPS process. It is required if wireless clients that do not support WPS attempts to connect to the wireless network.
WPS via Push Button	Click this button to initialize WPS feature using the push button method.

WPS via PIN	Enter the PIN code of the wireless device and click this button to initialize WPS feature using the PIN method.
--------------------	---

7.7 WDS Link Settings

Using WDS (Wireless Distribution System) will allow a network administrator or installer to connect to Access Points wirelessly. Doing so will extend the wired infrastructure to locations where cabling is not possible or inefficient to implement.

Note: Compatibility between different brands and models of access points is not guaranteed. It is recommended that the WDS network be created using the same models for maximum compatibility.

Also note: All Access Points in the WDS network needs to use the same Channel and Security settings.

To create a WDS network, please enter the MAC addresses of the Access Points that you want included in the WDS. There can be a maximum of four access points.

Note: Only applicable in WDS AP and WDS Bridge mode.

2.4G / WDS Link Settings

[Home](#)
[Reset](#)

Security	None ▾
AES Passphrase	<input type="text"/> (8-63 ASCII characters or 64 hexadecimal digits)

Caution: NAWDS was enabled, you need assign Wifi Channel manually later.

ID	MAC Address	Mode
1	00 : 02 : 6F : 11 : 22 : 33	Enable ▾
2	: : : : : :	Disable ▾
3	: : : : : :	Disable ▾
4	: : : : : :	Disable ▾

[Accept](#)
[Cancel](#)

5G / WDS Link Settings

Home

Reset

Security	None ▾
AES Passphrase	<input type="text"/> (8-63 ASCII characters or 64 hexadecimal digits)

Caution: NAWDS was enabled, you need assign Wifi Channel manually later.

ID	MAC Address	Mode
1	00 : 02 : 6F : 44 : 55 : 66	Enable ▾
2	: : : : : :	Disable ▾
3	: : : : : :	Disable ▾
4	: : : : : :	Disable ▾

Accept

Cancel

2.4G/5G WDS Link Settings

Security	Select None or AES from drop-down list.
AES Passphrase	Enter the key values you wish to use. Other AP(s) must use the same key to establish WDS link.
MAC Address	Enter the Access Point's MAC address to which you want to extend the wireless area.
Mode	Select Disable or Enable from the drop-down list.
Accept / Cancel	Click Accept to confirm the changes or Cancel to cancel and return previous settings.

8 Management

8.1 Administration

This page allows you to change the EAP600 username and password. By default, the username is **admin** and the password is: **admin**. The password can contain 0 to 12 alphanumeric characters and is case sensitive.

Login Setting

[Home](#)
[Reset](#)

New Name	<input type="text" value="admin"/>
Old Password	<input type="password"/>
New Password	<input type="password"/>
Confirm Password	<input type="password"/>

Login Setting	
New Name	Enter a new username for logging in to the New Name entry box.
Old Password	Enter the old password for logging in to the Old Password entry box.
New Password	Enter the new password for logging in to the New Password entry box.
Confirm Password	Re-enter the new password in the Confirm Password entry box for confirmation.
Save/Apply / Cancel	Click Save/Apply to apply the changes or Cancel to return previous settings.

8.2 Management VLAN Settings

This page allows you to assign a VLAN tag to the packets. A VLAN is a group of computers on a network whose software has been configured so that they behave as if they were on a separate Local Area Network (LAN). Computers on VLAN do not have to be physically located next to one another on the LAN.

Note: Only applicable in Access Point and WDS AP mode.

Management VLAN Settings

Home

Reset

2.4G Current Profiles				
SSID	Security	Isolation	VID	Enable
EnGeniusD7AC6C-2.4G	WPA-PSK Mixed TKIP/AES	<input type="checkbox"/>	1	<input checked="" type="checkbox"/>
EnGeniusD7AC6C_2-2.4G	None	<input type="checkbox"/>	2	<input type="checkbox"/>
EnGeniusD7AC6C_3-2.4G	None	<input type="checkbox"/>	3	<input type="checkbox"/>
EnGeniusD7AC6C_4-2.4G	None	<input type="checkbox"/>	4	<input type="checkbox"/>
EnGeniusD7AC6C_5-2.4G	None	<input type="checkbox"/>	5	<input type="checkbox"/>
EnGeniusD7AC6C_6-2.4G	None	<input type="checkbox"/>	6	<input type="checkbox"/>
EnGeniusD7AC6C_7-2.4G	None	<input type="checkbox"/>	7	<input type="checkbox"/>
EnGeniusD7AC6C_8-2.4G	None	<input type="checkbox"/>	8	<input type="checkbox"/>

5G Current Profiles				
SSID	Security	Isolation	VID	Enable
EnGeniusD7AC6D-5G	WPA-PSK Mixed TKIP/AES	<input type="checkbox"/>	51	<input checked="" type="checkbox"/>
EnGeniusD7AC6D_2-5G	None	<input type="checkbox"/>	52	<input type="checkbox"/>
EnGeniusD7AC6D_3-5G	None	<input type="checkbox"/>	53	<input type="checkbox"/>
EnGeniusD7AC6D_4-5G	None	<input type="checkbox"/>	54	<input type="checkbox"/>
EnGeniusD7AC6D_5-5G	None	<input type="checkbox"/>	55	<input type="checkbox"/>
EnGeniusD7AC6D_6-5G	None	<input type="checkbox"/>	56	<input type="checkbox"/>
EnGeniusD7AC6D_7-5G	None	<input type="checkbox"/>	57	<input type="checkbox"/>
EnGeniusD7AC6D_8-5G	None	<input type="checkbox"/>	58	<input type="checkbox"/>

Caution: If you reconfigure the Management VLAN ID, you may lose connectivity to the access point. Verify that the switch and DHCP server can support the reconfigured VLAN ID, and then re-connect to the new IP address.

Management VLAN ID	<input checked="" type="radio"/> No VLAN tag <input type="radio"/> Specified VLAN ID <input type="text"/> (must be in the range 1 ~ 4094.)
--------------------	--

Accept

Cancel

Management VLAN (Only applicable in Access Point mode)	
Profile Isolation	Restricted client to communicate with different VID by selecting the radio button.
VLAN ID	Specify the VLAN tag for each profile.
Management VLAN ID	If your network includes VLANs, you can specify a VLAN ID for packets pass through the Access Point with a tag. Otherwise, select No VLAN tag .
Accept / Cancel	Click Accept to confirm the changes or Cancel to cancel and return previous settings.

Note:

1. If you reconfigure the Management VLAN ID, you may lose your connection to the EAP600. Verify that the DHCP server supports the reconfigured VLAN ID and then reconnect to the EAP600 using the new IP address.
2. Clicking **Accept** does not apply the changes. To apply them, use Status > Save/Load (see section 5.1).

8.3 Wireless Traffic Shaping

Traffic shaping regulates the flow of packets leaving an interface to deliver improved Quality of Service.

Wireless Traffic Shaping

[Home](#)
[Reset](#)

Enable Traffic Shaping	<input checked="" type="radio"/> Enable <input type="radio"/> Disable
Incoming Traffic Limit	<input type="text" value="1000"/> kbit/s (512-99999999)
Outgoing Traffic Limit	<input type="text" value="2000"/> kbit/s (512-99999999)

[Accept](#)
[Cancel](#)

Wireless Traffic Shaping	
Enable Traffic Shaping	Check this option to enable wireless traffic shaping.
Incoming Traffic Limit	Specify the wireless transmission speed used for downloading.
Outgoing Traffic Limit	Specify the wireless transmission speed used for uploading.
Accept / Cancel	Click Accept to confirm the changes or Cancel to cancel and return previous settings.

8.4 SNMP Settings

This page allows you to assign the Contact Details, Location, Community Name, and Trap Settings for Simple Network Management Protocol (SNMP). This is a networking management protocol used to monitor network attached devices. SNMP allows messages (called protocol data units) to be sent to various parts of the network. Upon receiving these messages, SNMP compatible devices (called agents) return the data stored in their Management Information Bases.

SNMP Settings

[Home](#)
[Reset](#)

SNMP	<input checked="" type="radio"/> Enable <input type="radio"/> Disable
Contact	<input type="text"/>
Location	<input type="text"/>
Community Name (Read Only)	public
Community Name (Read/Write)	private
Trap Destination Address	<input type="text"/>
Trap Destination Community Name	public
SNMPv3	<input checked="" type="radio"/> v3Enable <input type="radio"/> v3Disable
User Name	admin
Auth Protocol	MD5 ▾
Auth Key	12345678
Priv Protocol	DES ▾
Priv Key	12345678
Engine ID	<input type="text"/>

[Save/Apply](#)
[Cancel](#)

SNMP	
SNMP Enable/Disable	Enable or Disable SNMP feature.
Contact	Specify the contact details of the device
Location	Specify the location of the device.
Community Name (Read Only)	Specify the password for the SNMP community for read only access.
Community Name (Read/Write)	Specify the password for the SNMP community with read/write access.
Trap	
Trap Destination Address	Specify the IP address of the computer that will receive the SNMP traps.
Trap Destination Community Name	Specify the password for the SNMP trap community.
SNMPv3	
SNMPv3 Enable/Disable	Enable or Disable SNMPv3 feature.
User Name	Specify the username for SNMPv3.
Auth Protocol	Select the authentication protocol type: MDS or SHA .
Auth Key	Specify the authentication key for authentication.
Priv Protocol	Select the privacy protocol type: DES .
Priv Key	Specify the privacy key for privacy.
Engine ID	Specify the engine ID for SNMPv3.
Save/Apply / Cancel	Click Save/Apply to apply the changes or Cancel to return previous settings.

8.5 Backup/Restore

This page allows you to save the current device configurations. When you save the configurations, you also can reload the saved configurations into the device through the **Restore Saved Settings from A File** section. If extreme problems occur, or if you have set the EAP600 wrongly, you can use the **Factory Default** button in the **Revert to Factory Default Settings** section to restore all the configurations of the EAP600 to the original default settings.

Backup/Restore Settings

[Home](#)
[Reset](#)

Save A Copy of Current Settings

Restore Saved Settings from A File

Revert to Factory Default Settings

Backup/Restore	
Save A Copy of Current Settings	Click Backup to save the current configured settings.
Restore Saved Settings from A File	To restore settings that have been previously backed up, click Browse , select the file, and click Restore .
Revert to Factory Default Settings	Click Factory Default button to restore the EAP600 to its factory default settings.

8.6 Auto Reboot Settings

You can specify how long to reboot the EAP600 periodically.

Auto Reboot Settings

[Home](#)
[Reset](#)

Auto Reboot Setting	Disable ▾
Frequency of Auto Reboot	Min ▾ 10 Mins ▾

Auto Reboot Settings	
Auto Reboot Setting	Enable or disable the auto reboot function.
Frequency of Auto Reboot	To specify the time to reboot the EAP600 by Min, Hour, Day or Week.
Save/Apply / Cancel	Click Save/Apply to apply the changes or Cancel to return previous settings.

8.7 Firmware Upgrade

This page allows you to upgrade the firmware of the EAP600.

Firmware Upgrade

[Home](#)[Reset](#)

Current firmware version: 1.1.11

Locate and select the upgrade file from your hard disk:

To perform the Firmware Upgrade:

1. Click the **Browse** button and navigate the OS File System to the location of the upgrade file.
2. Select the upgrade file. The name of the file will appear in the *Upgrade File* field.
3. Click the **Upload** button to commence the firmware upgrade.

Note: The device is unavailable during the upgrade process and must restart when the upgrade is completed. Any connections to or through the device will be lost.

8.8 Time Setting

This page allows you to set the internal clock of the EAP600.

Time Settings

[Home](#)
[Reset](#)

Time

Manually Set Date and Time
 2012 / 06 / 15 12 : 34 [Synchronize with PC](#)

Automatically Get Date and Time
 Time Zone: UTC+00:00 Gambia, Liberia, Morocco
 User defined NTP Server: 209.81.9.7

Enable Daylight Saving
 Start Time: January 1st Sun 12 am
 End Time: January 1st Mon 12 am

[Save/Apply](#) [Cancel](#)

Time	
Manually Set Date and Time	Manually specify the date and time.
Automatically Get Date and Time	Select a time zone from the drop-down list and check whether you want to enter the IP address of an NTP server or use the default NTP server to get have the internal clock set automatically.
Enable Daylight Saving	Check whether daylight savings applies to your area.

8.9 Log

This page allows you to setup Syslog and local log functions of the EAP600.

Log

[Home](#)
[Reset](#)

Syslog

Syslog	Disable ▾
Log Server IP Address	0 . 0 . 0 . 0

Local log

Local Log	Enable ▾
-----------	----------

Log	
Syslog	Enable or disable the syslog function.
Log Server IP Address	Enter the IP address of the log server.
Local Log	Enable or disable the local log service.
Save/Apply / Cancel	Click Save/Apply to apply the changes or Cancel to return previous settings.

8.10 Diagnostics

This page allows you to analyze the connection quality of the EAP600 and trace the routing table to a target in the network.

Diagnostics

[Home](#)
[Reset](#)

Ping Test Parameters

Target IP	<input type="text"/>
Ping Packet Size	64 Bytes
Number of Pings	4
<input type="button" value="Start Ping"/>	

Traceroute Test Parameters

Traceroute target	<input type="text"/>
<input type="button" value="Start Traceroute"/>	

Diagnosis	
Target IP	Enter the IP address you would like to search.
Ping Packet Size	Enter the packet size of each ping.
Number of Pings	Enter the number of times you want to ping.
Start Ping	Click Start Ping to begin pinging target device (via IP).
Traceroute Target	Enter an IP address or domain name you want to trace.
Start Traceroute	Click Start Traceroute to begin the trace route operation.

8.11 LED Control

This page allows you to control LED on/off for Power, LAN interface, 2.4G/5G WLAN interface and WPS.

LED Control

[Home](#)[Reset](#)

LED Control

Power LED	<input checked="" type="radio"/> ON <input type="radio"/> OFF
LAN LED	<input checked="" type="radio"/> ON <input type="radio"/> OFF
2.4G LED	<input checked="" type="radio"/> ON <input type="radio"/> OFF
5G LED	<input checked="" type="radio"/> ON <input type="radio"/> OFF
WPS LED	<input checked="" type="radio"/> ON <input type="radio"/> OFF

[Save/Apply](#)[Cancel](#)

8.12 Logout

Click [**Logout**] in **Management** menu to logout.



8.13 Reset

In some circumstances, it may be required to force the device to reboot. Click on **Reboot the Device** to reboot the EAP600.

Reset

[Home](#)[Reset](#)

The System Settings section allows you to reboot the device, or restore the device to the factory default settings. Restoring the unit to the factory default settings will erase all settings, including any rules you have created.

System Commands

[Reboot the Device](#)[Restore to Factory Defaults](#)

Appendix A – FCC Interference Statement

Federal Communication Commission Interference Statement

This equipment has been tested and found to comply with the limits for a Class B digital device, pursuant to Part 15 of the FCC Rules. These limits are designed to provide reasonable protection against harmful interference in a residential installation. This equipment generates, uses and can radiate radio frequency energy and, if not installed and used in accordance with the instructions, may cause harmful interference to radio communications. However, there is no guarantee that interference will not occur in a particular installation. If this equipment does cause harmful interference to radio or television reception, which can be determined by turning the equipment off and on, the user is encouraged to try to correct the interference by one of the following measures:

- Reorient or relocate the receiving antenna.
- Increase the separation between the equipment and receiver.
- Connect the equipment into an outlet on a circuit different from that to which the receiver is connected.
- Consult the dealer or an experienced radio/TV technician for help.

FCC Caution: Any changes or modifications not expressly approved by the party responsible for compliance could void the user's authority to operate this equipment.

This device complies with Part 15 of the FCC Rules. Operation is subject to the following two conditions: (1) This device may not cause harmful interference, and (2) this device must accept any interference received, including interference that may cause undesired operation.

This transmitter must not be co-located or operating in conjunction with any other antenna or transmitter.

Operations in the 5.15-5.25GHz band are restricted to indoor usage only.

IMPORTANT NOTE:

FCC Radiation Exposure Statement:

This equipment complies with FCC radiation exposure limits set forth for an uncontrolled environment. This equipment should be installed and operated with minimum distance 21cm between the radiator & your body.

Note: The country code selection is for non-US model only and is not available to all US model. Per FCC regulation, all WiFi product marketed in US must fixed to US operation channels only.

Appendix B – IC Interference Statement

Industry Canada statement:

This device complies with RSS-210 of the Industry Canada Rules. Operation is subject to the following two conditions: (1) This device may not cause harmful interference, and (2) this device must accept any interference received, including interference that may cause undesired operation.

Ce dispositif est conforme à la norme CNR-210 d'Industrie Canada applicable aux appareils radio exempts de licence. Son fonctionnement est sujet aux deux conditions suivantes: (1) le dispositif ne doit pas produire de brouillage préjudiciable, et (2) ce dispositif doit accepter tout brouillage reçu, y compris un brouillage susceptible de provoquer un fonctionnement indésirable.

Caution :

- (i) the device for operation in the band 5150-5250 MHz is only for indoor use to reduce the potential for harmful interference to co-channel mobile satellite systems;
- (ii) high-power radars are allocated as primary users (i.e. priority users) of the bands 5250-5350 MHz and 5650-5850 MHz and that these radars could cause interference and/or damage to LE-LAN devices.

Avertissement:

- (i) les dispositifs fonctionnant dans la bande 5150-5250 MHz sont réservés uniquement pour une utilisation à l'intérieur afin de réduire les risques de brouillage préjudiciable aux systèmes de satellites mobiles utilisant les mêmes canaux;
- (ii) De plus, les utilisateurs devraient aussi être avisés que les utilisateurs de radars de haute puissance sont désignés utilisateurs principaux (c.-à-d., qu'ils ont la priorité) pour les bandes 5250-5350 MHz et 5650-5850 MHz et que ces radars pourraient causer du brouillage et/ou des dommages aux dispositifs LAN-EL.

IMPORTANT NOTE: (For mobile devices usage)

Radiation Exposure Statement:

This equipment complies with IC radiation exposure limits set forth for an uncontrolled environment. This equipment should be installed and operated with minimum distance 21cm between the radiator & your body.

NOTE IMPORTANTE: (Pour l'utilisation de dispositifs mobiles)

Déclaration d'exposition aux radiations:

Cet équipement est conforme aux limites d'exposition aux rayonnements IC établies pour un environnement non contrôlé. Cet équipement doit être installé et utilisé avec un minimum de 21cm de distance entre la source de rayonnement et votre corps.

Appendix C – CE Interference Statement

Europe – EU Declaration of Conformity

This device complies with the essential requirements of the R&TTE Directive 1999/5/EC. The following test methods have been applied in order to prove presumption of conformity with the essential requirements of the R&TTE Directive 1999/5/EC:

- EN60950-1
- Safety of Information Technology Equipment

- EN50385
- Generic standard to demonstrate the compliance of electronic and electrical apparatus with the basic restrictions related to human exposure to electromagnetic fields (0 Hz - 300 GHz)

- EN 300 328
- Electromagnetic compatibility and Radio spectrum Matters (ERM); Wideband Transmission systems; Data transmission equipment operating in the 2,4 GHz ISM band and using spread spectrum modulation techniques; Harmonized EN covering essential requirements under article 3.2 of the R&TTE Directive

- EN 301 489-1
- Electromagnetic compatibility and Radio Spectrum Matters (ERM); ElectroMagnetic Compatibility (EMC) standard for radio equipment and services; Part 1: Common technical requirements

- EN 301 489-17
- Electromagnetic compatibility and Radio spectrum Matters (ERM); ElectroMagnetic Compatibility (EMC) standard for radio equipment and services; Part 17: Specific conditions for 2,4 GHz wideband transmission systems and 5 GHz high performance RLAN equipment

- EN 301 893
- Broadband Radio Access Networks (BRAN); 5 GHz high performance RLAN; Harmonized EN covering essential requirements of article 3.2 of the R&TTE Directive









This device is a 2.4 GHz/5 GHz wideband transmission system (transceiver), intended for use in all EU member states and EFTA countries, except in France and Italy where restrictive use applies.









In Italy the end-user should apply for a license at the national spectrum authorities in order to obtain authorization to use the device for setting up outdoor radio links and/or for supplying public access to telecommunications and/or network services.

This device may not be used for setting up outdoor radio links in France and in some areas the RF output power may be limited to 10 mW EIRP in

the frequency range of 2454 – 2483.5 MHz. For detailed information the end-user should contact the national spectrum authority in France.

CE 0560

 Česky [Czech]	<i>[Jméno výrobce]</i> tímto prohlašuje, že tento <i>[typ zařízení]</i> je ve shodě se základními požadavky a dalšími příslušnými ustanoveními směrnice 1999/5/ES.
 Dansk [Danish]	Undertegnede <i>[fabrikantens navn]</i> erklærer herved, at følgende udstyr <i>[udstyrets typebetegnelse]</i> overholder de væsentlige krav og øvrige relevante krav i direktiv 1999/5/EF.
 Deutsch [German]	Hiermit erklärt <i>[Name des Herstellers]</i> , dass sich das Gerät <i>[Gerätetyp]</i> in Übereinstimmung mit den grundlegenden Anforderungen und den übrigen einschlägigen Bestimmungen der Richtlinie 1999/5/EG befindet.
 Eesti [Estonian]	Käesolevaga kinnitab <i>[tootja nimi = name of manufacturer]</i> seadme <i>[seadme tüüp = type of equipment]</i> vastavust direktiivi 1999/5/EÜ põhinõuetele ja nimetatud direktiivist tulenevatele teistele asjakohastele sätetele.
 English	Hereby, <i>[name of manufacturer]</i> , declares that this <i>[type of equipment]</i> is in compliance with the essential requirements and other relevant provisions of Directive 1999/5/EC.
 Español [Spanish]	Por medio de la presente <i>[nombre del fabricante]</i> declara que el <i>[clase de equipo]</i> cumple con los requisitos esenciales y cualesquiera otras disposiciones aplicables o exigibles de la Directiva 1999/5/CE.
 Ελληνική [Greek]	ΜΕ ΤΗΝ ΠΑΡΟΥΣΑ <i>[name of manufacturer]</i> ΔΗΛΩΝΕΙ ΟΤΙ <i>[type of equipment]</i> ΣΥΜΜΟΡΦΩΝΕΤΑΙ ΠΡΟΣ ΤΙΣ ΟΥΣΙΩΔΕΙΣ ΑΠΑΙΤΗΣΕΙΣ ΚΑΙ ΤΙΣ ΛΟΙΠΕΣ ΣΧΕΤΙΚΕΣ ΔΙΑΤΑΞΕΙΣ ΤΗΣ ΟΔΗΓΙΑΣ 1999/5/EK.
 Français [French]	Par la présente <i>[nom du fabricant]</i> déclare que l'appareil <i>[type d'appareil]</i> est conforme aux exigences essentielles et aux autres dispositions pertinentes de la directive 1999/5/CE.
 Italiano [Italian]	Con la presente <i>[nome del costruttore]</i> dichiara che questo <i>[tipo di apparecchio]</i> è conforme ai requisiti essenziali ed alle altre disposizioni pertinenti stabilite dalla direttiva 1999/5/CE.
Latviski [Latvian]	Ar šo <i>[name of manufacturer / izgatavotāja nosaukums]</i> deklarē, ka <i>[type of equipment / iekārtas tips]</i> atbilst Direktīvas 1999/5/EK būtiskajām prasībām un citiem ar to saistītajiem noteikumiem.

Lietuvių [Lithuanian]	Šiuo <i>[manufacturer name]</i> deklaruoja, kad šis <i>[equipment type]</i> atitinka esminius reikalavimus ir kitas 1999/5/EB Direktyvos nuostatas.
 Nederlands [Dutch]	Hierbij verklaart <i>[naam van de fabrikant]</i> dat het toestel <i>[type van toestel]</i> in overeenstemming is met de essentiële eisen en de andere relevante bepalingen van richtlijn 1999/5/EG.
 Malti [Maltese]	Hawnhekk, <i>[isem tal-manifattur]</i> , jiddikjara li dan <i>[il-mudel tal-prodott]</i> jikkonforma mal- ħtiġijiet essenzjali u ma provvedimenti oħrajn rilevanti li hemm fid-Dirrettiva 1999/5/EC.
 Magyar [Hungarian]	Alulírott, <i>[gyártó neve]</i> nyilatkozom, hogy a <i>[... típus]</i> megfelel a vonatkozó alapvető követelményeknek és az 1999/5/EC irányelv egyéb előírásainak.
 Polski [Polish]	Niniejszym <i>[nazwa producenta]</i> oświadczam, że <i>[nazwa wyrobu]</i> jest zgodny z zasadniczymi wymogami oraz pozostałymi stosownymi postanowieniami Dyrektywy 1999/5/EC.
 Português [Portuguese]	<i>[Nome do fabricante]</i> declara que este <i>[tipo de equipamento]</i> está conforme com os requisitos essenciais e outras disposições da Directiva 1999/5/CE.
 Slovensko [Slovenian]	<i>[Ime proizvajalca]</i> izjavlja, da je ta <i>[tip opreme]</i> v skladu z bistvenimi zahtevami in ostalimi relevantnimi določili direktive 1999/5/ES.
Slovensky [Slovak]	<i>[Meno výrobcu]</i> týmto vyhlasuje, že <i>[typ zariadenia]</i> spĺňa základné požiadavky a všetky príslušné ustanovenia Smernice 1999/5/ES.
 Suomi [Finnish]	<i>[Valmistaja = manufacturer]</i> vakuuttaa täten että <i>[type of equipment = laitteen tyyppimerkintä]</i> tyyppinen laite on direktiivin 1999/5/EY oleellisten vaatimusten ja sitä koskevien direktiivin muiden ehtojen mukainen.
 Svenska [Swedish]	Härmed intygar <i>[företag]</i> att denna <i>[utrustningstyp]</i> står i överensstämmelse med de väsentliga egenskapskrav och övriga relevanta bestämmelser som framgår av direktiv 1999/5/EG.