

Wireless VoIP WGR615VV2 Manual

NETGEAR

NETGEAR, Inc.
4500 Great America Parkway
Santa Clara, CA 95054 USA

1.0
Version 1.0
September 2004

September 2004

Trademarks

NETGEAR is a trademark of Netgear, Inc.

Microsoft, Windows, and Windows NT are registered trademarks of Microsoft Corporation.

Other brand and product names are registered trademarks or trademarks of their respective holders.

Statement of Conditions

In the interest of improving internal design, operational function, and/or reliability, NETGEAR reserves the right to make changes to the products described in this document without notice.

NETGEAR does not assume any liability that may occur due to the use or application of the product(s) or circuit layout(s) described herein.

Federal Communications Commission (FCC) Compliance Notice: Radio Frequency Notice

This equipment has been tested and found to comply with the limits for a Class B digital device, pursuant to part 15 of the FCC Rules. These limits are designed to provide reasonable protection against harmful interference in a residential installation. This equipment generates, uses, and can radiate radio frequency energy and, if not installed and used in accordance with the instructions, may cause harmful interference to radio communications. However, there is no guarantee that interference will not occur in a particular installation. If this equipment does cause harmful interference to radio or television reception, which can be determined by turning the equipment off and on, the user is encouraged to try to correct the interference by one or more of the following measures:

- Reorient or relocate the receiving antenna.
- Increase the separation between the equipment and receiver.
- Connect the equipment into an outlet on a circuit different from that to which the receiver is connected.
- Consult the dealer or an experienced radio/TV technician for help.

Customer Support

Refer to the Support Information Card that shipped with your Wireless Router.

Users Information

Changes or modifications not expressly approved by the party responsible for compliance could void the user's authority to operate the equipment.

CAUTION:

- 1) To comply with FCC RF exposure compliance requirements, a separation distance of at least 20 cm must be maintained between the antenna of this device and all persons.
- 2) This transmitter must not be co-located or operating in conjunction with any other antenna or transmitter.

Contents

Chapter 1

About This Guide

Audience, Conventions, and Formats	1-1
Tips for Printing This Manual	1-2

Chapter 2

Getting to Know Your NETGEAR Wireless Router

Package Contents	2-1
The Front Panel	2-2
The Rear Panel	2-3

Chapter 3

Connecting the Router to the Internet

Prepare to Install Your Wireless Router	3-1
First, Connect the Wireless Router to the Internet	3-1
Now, Set Up a Computer for Wireless Connectivity	3-6
Troubleshooting Tips	3-7
Overview of How to Access the Wireless Router	3-8
How to Log On to the Wireless Router After Configuration Settings Have Been Applied	3-9
How to Bypass the Configuration Assistant	3-10
How to Manually Configure Your Internet Connection	3-10
Using the Smart Setup Wizard	3-12
NETGEAR Product Registration, Support, and Documentation	3-13

Chapter 4

Optimizing Wireless Connectivity and Security

Observe Performance, Placement, and Range Guidelines	4-1
Implement Appropriate Wireless Security	4-2
Understanding Wireless Settings	4-3
Information to Gather Before Changing Basic Wireless Settings	4-6
Default Factory Settings	4-7

How to Set Up and Test Basic Wireless Connectivity	4-7
How to Configure WEP	4-9
How to Configure WPA-PSK Wireless Security	4-11
How to Restrict Wireless Access by MAC Address	4-11
Chapter 5	
Doing Basic Router Housekeeping	
Changing the Administrator Password	5-1
Configuration File Management	5-2
Restoring and Backing Up the Configuration	5-2
Erasing the Configuration	5-3
Upgrading the Wireless Router Software	5-3
Chapter 6	
Troubleshooting Common Problems	
Basic Functioning	6-1
Power Light Not On	6-1
Lights Never Turn Off	6-2
LAN or Internet (WAN) Port Lights Not On	6-2
Troubleshooting the Web Configuration Interface	6-2
Troubleshooting the ISP Connection	6-3
Troubleshooting a TCP/IP Network Using a Ping Utility	6-5
Testing the LAN Path to Your Router	6-5
Testing the Path from Your Computer to a Remote Device	6-6
Restoring the Default Configuration and Password	6-7
Appendix A	
Technical Specifications	
Glossary	
List of Glossary Terms	G-1

Chapter 1

About This Guide

This chapter describes the intended audience, scope, conventions, and formats of this manual.

Audience, Conventions, and Formats

This reference manual assumes that the reader has basic computer and Internet skills. However, basic computer network, Internet, and firewall technologies tutorial information is provided in the Appendices and on the Netgear Web site.

This guide uses the following typographical conventions:

Table 1-1. Typographical Conventions

<i>italics</i>	Emphasis, books, CDs, URL names
bold	User input
SMALL CAPS	Screen text, file and server names, extensions, commands, IP addresses

This guide uses the following format to highlight special messages:

	Note: This format is used to highlight information of importance or special interest.
---	--

This manual is written for NETGEAR wireless routers.

Table 1-2. Manual Publication Details

Manual Publication Date	September 2004
-------------------------	----------------

	Note: Product updates are available on the NETGEAR Web site at http://kbserver.netgear.com .
---	---

Chapter 2

Getting to Know Your NETGEAR Wireless Router

NETGEAR wireless routers provide connections for multiple computers to the Internet through an external broadband access device such as a cable modem or DSL modem that is normally intended for use by a single computer. This chapter introduces the NETGEAR Wireless Router.

Package Contents

The product package should contain the following items:

- Wireless Router.
- AC power adapter.
- A Category 5 (CAT5) Ethernet cable.
- The Setup CD, including:
 - This guide.
 - Application Notes and other helpful information.
- Registration, Warranty Card, and Support Information Card.

If any of the parts are incorrect, missing, or damaged, contact your NETGEAR dealer. Keep the carton, including the original packing materials, in case you need to return the router for repair.

The Front Panel

The front of the wireless router includes these status lights you can use to verify connections.

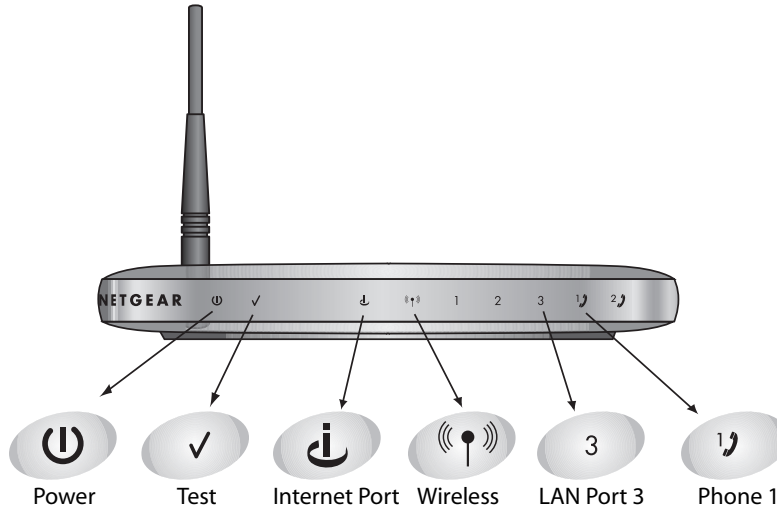

Figure 2-1: wireless router Front Panel

Viewed from left to right, the table below describes the lights on the front panel of the router.

Table 2-1. Status Light Descriptions

Label	Activity	Description
Power	On Green Solid Off	Power is supplied to the router. Power is not supplied to the router.
Test	Blinking Off	The router is performing its diagnostic test. The router successfully completed its diagnostic test.
Internet Port	On Blink	The Internet port has detected a link with an attached device. Data is being transmitted or received by the Internet port.
Wireless	On	The 802.11g wireless interface is enabled.
Internet Port	On Blink	The Internet port has detected a link with an attached device. Data is being transmitted or received by the Internet port.
Phone Port	Off On	The phone port has not yet been provisioned by the service provider. The phone port has been provisioned by the service provider.
LAN Ports	Green Amber	The LAN port has detected a 100 Mbps link with an attached device. The LAN port has detected a 10 Mbps link with an attached device.

The Rear Panel

The rear panel of the wireless router contains the items listed below.

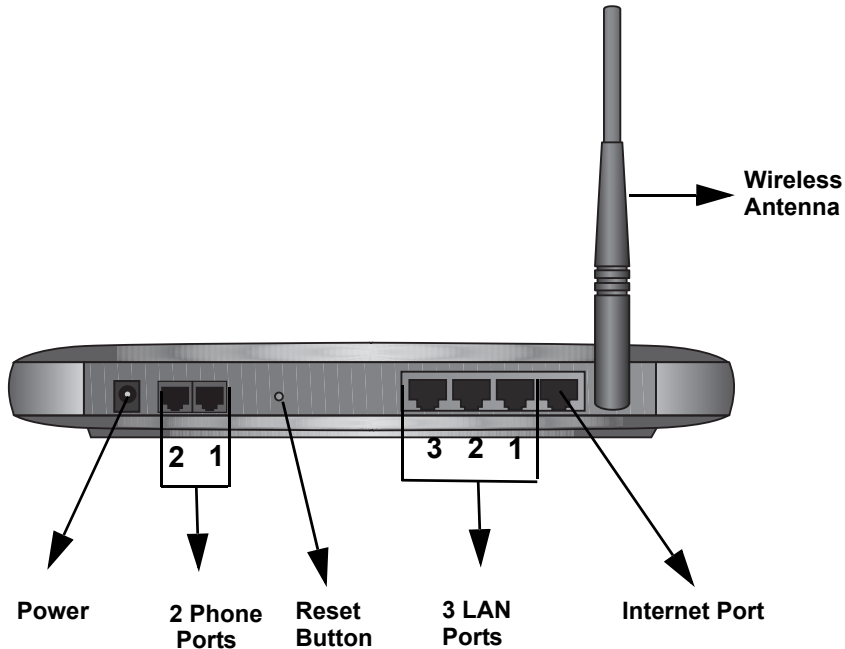

Figure 1-2: wireless router Rear Panel

Viewed from left to right, the rear panel contains the following features:

- Outlet for **12V DC @ 1.5A output** AC power adapter
- Two phone ports
- Factory default reset push button for [Restoring the Default Configuration and Password](#)
- Three LAN phone ports
- Internet (WAN) Ethernet port for connecting the router to a cable or DSL modem
- Wireless antenna

Chapter 3

Connecting the Router to the Internet

This chapter describes how to set up the router on your local area network (LAN) and connect to the Internet. You will find out how to configure your wireless router for Internet access.

Follow these instructions to set up your router.

Prepare to Install Your Wireless Router

- *For Cable Modem Service:* When you perform the wireless router setup steps be sure to use the computer you first registered with your cable ISP.
- *For DSL Service:* You may need information such as the DSL login name/e-mail address and password in order to complete the wireless router setup.

Before proceeding with the wireless router installation, familiarize yourself with the contents of the Setup CD, especially this manual and the tutorials for configuring computers for networking.

First, Connect the Wireless Router to Your Network

1. CONNECT THE WIRELESS ROUTER, THE COMPUTER, AND THE MODEM

- a. Turn off your computer.
- b. Turn off the cable or DSL broadband modem.

- c. Locate the Ethernet cable (cable 1 in the diagram) that connects your PC to the modem.

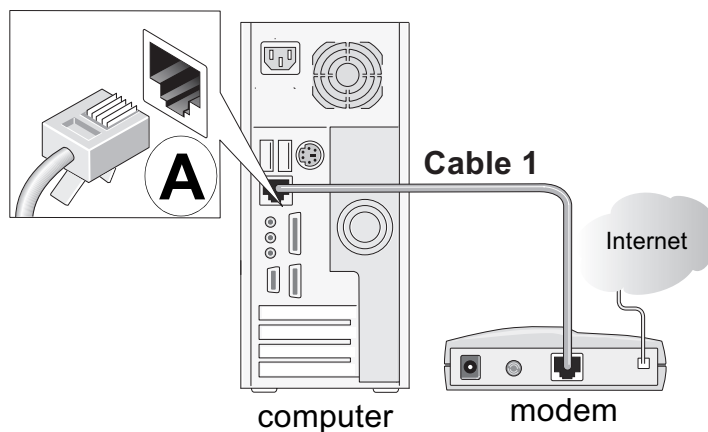

Figure 3-1: Disconnect the Ethernet cable from the computer

- d. Disconnect the cable at the computer end only, point A in the diagram above.
- e. Look at the label on the bottom of the wireless router. Locate the Internet port. Securely insert the Ethernet cable from your modem (cable 1 in the diagram below) into the Internet port of the wireless router as shown in point B of the diagram below.

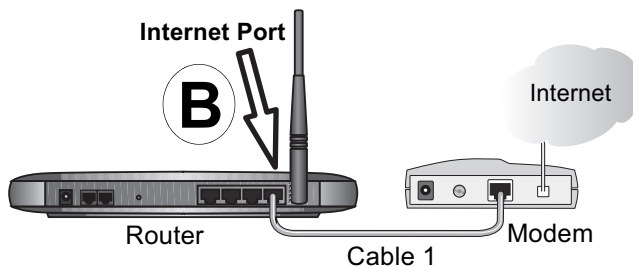

Figure 3-2: Connect the wireless router to the modem

Note: Place the wireless router in a location which conforms to the [“Observe Performance, Placement, and Range Guidelines”](#) on page 4-1. The stand provided with the wireless router provides a convenient, space-saving way of installing the wireless router. Avoid stacking it on other electronic equipment.

- f. Securely insert the cable that came with your wireless router (the NETGEAR cable in the diagram below) into a LAN port on the router such as LAN port 4 (point C in the diagram), and the other end into the Ethernet port of your computer (point D in the diagram).

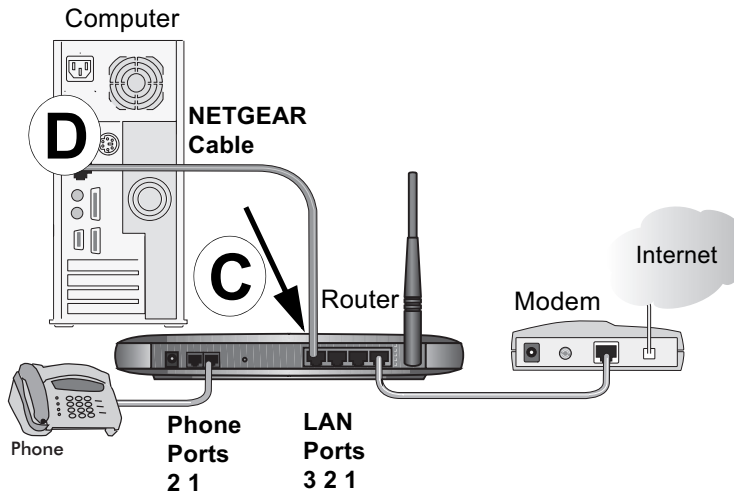

Figure 3-3: Connect the computer to the wireless router

If you have a voice service or plan to order it, connect a telephone to Phone Port 1 on the wireless router using a standard phone cord (not included).

Your network cables are connected and you are ready to restart your network.

2. RESTART YOUR NETWORK IN THE CORRECT SEQUENCE

Warning: Failure to restart your network in the correct sequence could prevent you from connecting to the Internet.

- a. First, plug in and turn on the broadband modem. Wait about 2 minutes.
- b. Now, plug in the power cord to your wireless router. Wait about 2 minutes.
- c. Last, turn on your computer.

Note: For DSL customers, if software logs you in to the Internet, *do not* run that software. You may need to go to the Internet Explorer Tools menu, Internet Options, Connections tab page where you can select “Never dial a connection.”

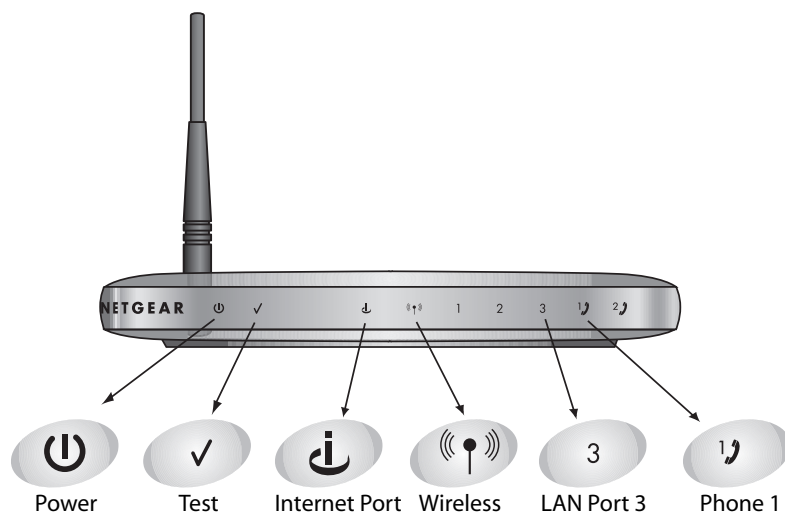

Figure 3-4: Verify the connections according to the status lights on the wireless router

- d. Check the wireless router status lights to verify the following:
- *Power:* The power light should turn solid green. If it does not, see [“Troubleshooting Tips” on page 3-7](#).
 - *Test:* The test light should be off. The test light blinks when the router is first turned on then goes off. If after 2 minutes it is still on, see the Troubleshooting Tips below.
 - *Internet:* The Internet port light should be lit. If not, make sure the Ethernet cable is securely attached to the wireless router Internet port and the modem, and the modem is powered on.
 - *Wireless:* The wireless lights should be lit. If not, see [“Troubleshooting Tips” on page 3-7](#).
 - *LAN:* A LAN light should be lit. Green indicates your computer is communicating at 100 Mbps; yellow indicates 10 Mbps. If a LAN light is not lit, check that the Ethernet cable from the computer to the router is securely attached at both ends, and that the computer is turned on.
 - *Phone:* The Phone light will not be lit until your phone service provider provisions the phone service. Check the user guide from your phone service provider for details on provisioning the phone service.

3. OPEN A BROWSER AND LOG IN TO THE ROUTER

For DSL customers, if your Internet service provider had you install software logs you in to the Internet, *do not* run that software. If such software automatically starts when you open a browser, you may need to go to the Internet Explorer Tools menu, Internet Options, Connections tab page where you can select “Never dial a connection.”

1. From the Ethernet connected computer you just set up, open a browser such as Internet Explorer or Netscape® Navigator.

Note: If your browser connects you to the Internet, you can skip this section and proceed to the [Now, Set Up a Computer for Wireless Connectivity](#) section below.

2. Connect to the wireless router by typing **http://192.168.61.1** in the address field of your browser, then click **Enter**.



3. For security reasons, the router has its own user name and password. When prompted, enter **admin** for the router user name and **password** for the router password, both in lower case letters.

Note: The router user name and password are not the same as any user name or password you may use to log in to your Internet connection.

A login window like the one shown below opens:



Figure 3-5: Login window

Note: If you cannot connect to the wireless router, verify your cables are connected correctly, that the router is powered on, and that the networking setup of your computer is set to obtain its settings automatically via DHCP. It should be set to obtain *both* IP and DNS server addresses automatically, which is usually so. For help with this, please see the tutorials on the CD.

After logging in to the router, you will see the Internet connection Smart Wizard on the settings main page.

Use the Smart Wizard to Configure Your Wireless Router



1. You are now connected to the router. If you do not see the menu above, click the Setup Wizard link on the upper left of the main menu.
2. Click **Next** to proceed. Input your ISP settings, as needed.

Note: If you choose not to use the Setup Smart Wizard, you can manually configure your Internet connection settings by following the procedures in the Setup Manual on the CD.

Unless your ISP automatically assigns your configuration automatically via DHCP, you will need the configuration parameters from your ISP.

3. When the router successfully detects an active Internet service, the router's Internet LED goes on. The Setup Smart Wizard reports which connection type it discovered, and displays the appropriate configuration menu. If the Setup Smart Wizard finds no connection, you will be prompted to check the physical connection between your router and the cable or DSL modem.
4. The Setup Smart Wizard will report the type of connection it finds and prompts you for the settings.
5. At the end of the Setup Wizard, click the **Test** button to verify your Internet connection and register your product. If you have trouble connecting to the Internet, use the Basic Setup Troubleshooting Tips below to correct basic problems, or refer to the Setup Manual on the CD.

You are now connected to the Internet and the wireless feature of the wireless router is enabled! Next, configure your wireless computer.

Now, Set Up a Computer for Wireless Connectivity

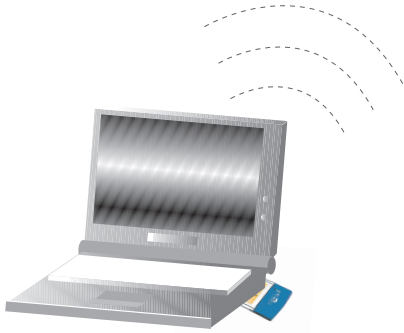

Wireless Adapter in a Notebook Computer

Configure the wireless adapter to match your wireless router settings exactly. If you changed the default Network Name (SSID), be sure to use what you set in the wireless router.

WIRELESS FEATURE	DEFAULT SETTING
802.11g Network Name (SSID)	NETGEAR
WEP or WPA Security	Disabled

Warning: The Network Name (SSID) is case sensitive. Typing nETgear for the SSID will not work.

Note: If your wireless adapter does not support WPA, you must reconfigure the wireless router according to the options available on your wireless adapter.

If you need to verify the wireless settings of your wireless router, go to a computer that is connected via an Ethernet cable to the wireless router and simply open a browser. Enter **http://192.168.61.1** in your browser. Then, when prompted, enter **admin** as the user name and **password** for the password both in lower case letters.

You are now wirelessly connected to the Internet with strong security!

Troubleshooting Tips

Here are some tips for correcting simple problems you may have.

Be sure to restart your network in this sequence:

1. Turn off *and* unplug the modem, turn off the wireless router, and turn off the computer
2. Turn on the modem, wait two minutes
3. Turn on the wireless router and wait 1 minute
4. Turn on the computer.

Make sure the Ethernet cables are securely plugged in.

- The Internet status light on the wireless router will be lit if the Ethernet cable to the wireless router from the modem is plugged in securely and the modem and wireless router are turned on.
- For each powered on computer connected to the wireless router with a securely plugged in Ethernet cable, the corresponding wireless router LAN port status light will be lit. The label on the bottom of the wireless router identifies the number of each LAN port.

Make sure the wireless settings in the computer and router match exactly.

The Wireless Network Name (SSID) and security settings of the router and wireless computer must match exactly.

Make sure the network settings of the computer are correct.

- LAN and wirelessly connected computers *must* be configured to obtain an IP address automatically via DHCP. Please see [Appendix C, “Preparing Your Network”](#) or the animated tutorials on the CD for help with this.
- Some cable modem ISPs require you to use the MAC address of the computer registered on the account. If so, in the Router MAC Address section of the Basic Settings menu, select “Use this Computer’s MAC Address.” The router will then capture and use the MAC address of the computer that you are now using. You must be using the computer that is registered with the ISP. Click **Apply** to save your settings. Restart the network in the correct sequence.

Check the router status lights to verify correct router operation.

- If the Power light does not turn solid green within 2 minutes after turning the router on, reset the router according to the instructions in [“Restoring the Default Configuration and Password” on page 6-7](#).
- If the Wireless light does not come on, verify that the wireless feature is turned on according to the instructions in [“Understanding Wireless Settings” on page 4-3](#).

How to Manually Configure Your Internet Connection

You can manually configure your router using the menu below, or you can allow the Setup Wizard to determine your configuration as described in the previous section.

ISP Does Not Require Login

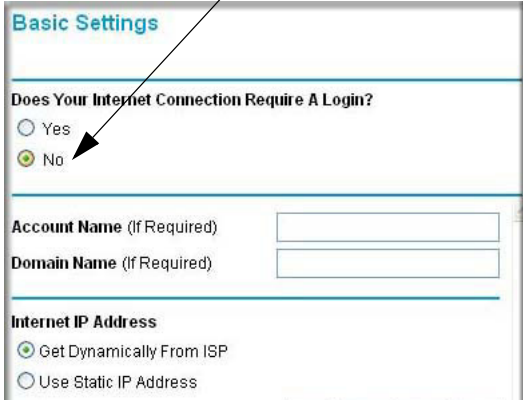

ISP Does Require Login

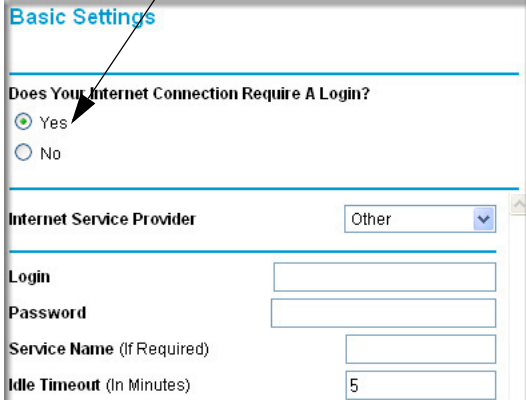

Figure 3-6: Browser-based configuration Basic Settings menus

You can manually configure the router using the Basic Settings menu shown in [Figure 3-6](#) using these steps:

1. Connect to the wireless router by typing **http://192.168.61.1** in the address field of your browser, then click **Enter**.
2. For security reasons, the wireless router has its own user name and password. When prompted, enter **admin** for the router user name and **password** for the router password, both in lower case letters.
3. Click **Basic Settings** on the Setup menu.
4. If your Internet connection does not require a login, click No at the top of the Basic Settings menu and fill in the settings according to the instructions below. If your Internet connection does require a login, click Yes, and skip to step 5.
 - a. Enter your Account Name (may also be called Host Name) and Domain Name. These parameters may be necessary to access your ISP's services such as mail or news servers.

b. Internet IP Address:

If your ISP has assigned you a permanent, fixed (static) IP address for your computer, select “Use static IP address”. Enter the IP address that your ISP assigned. Also enter the netmask and the Gateway IP address. The Gateway is the ISP’s router to which your router will connect.

c. Domain Name Server (DNS) Address:

If you know that your ISP does not automatically transmit DNS addresses to the router during login, select “Use these DNS servers” and enter the IP address of your ISP’s Primary DNS Server. If a Secondary DNS Server address is available, enter it also.

Note: If you enter an address here, restart the computers on your network so that these settings take effect.

d. Router’s MAC Address:

This section determines the Ethernet MAC address that will be used by the router on the Internet port. Some ISPs will register the Ethernet MAC address of the network interface card in your computer when your account is first opened. They will then only accept traffic from the MAC address of that computer. This feature allows your router to masquerade as that computer by “cloning” its MAC address.

To change the MAC address, select “**Use this Computer’s MAC address.**” The router will then capture and use the MAC address of the computer that you are now using. You must be using the one computer that is allowed by the ISP. Or, select “Use this MAC address” and type it in here.

e. Click **Apply** to save your settings.

5. If your Internet connection does require a login, fill in the settings according to the instructions below. Select Yes if you normally must launch a login program such as Enternet or WinPOET in order to access the Internet.

Note: After you finish setting up your router, you will no longer need to launch the ISP’s login program on your computer in order to access the Internet. When you start an Internet application, your router will automatically log you in.

- a. Select your Internet service provider from the drop-down list.

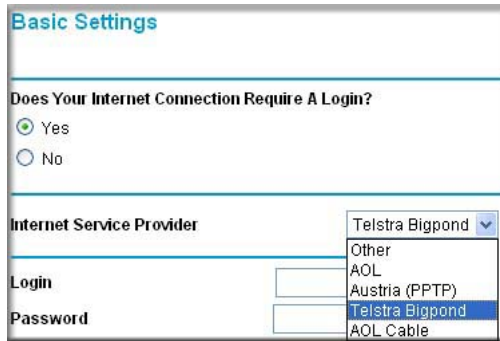

The screenshot shows a web interface titled "Basic Settings". It contains a section "Does Your Internet Connection Require A Login?" with radio buttons for "Yes" (selected) and "No". Below this is a section for "Internet Service Provider" with a dropdown menu currently showing "Telstra Bigpond". To the left of the dropdown are input fields for "Login" and "Password". The dropdown menu is open, showing a list of ISPs: "Other", "AOL", "Austria (PPTP)", "Telstra Bigpond" (highlighted), and "AOL Cable".

Figure 3-7: Basic Settings ISP list

Note: Not all ISPs are listed here. The ones on this list have special requirements.

- b. The screen will change according to the ISP settings requirements of the ISP you select.
- c. Fill in the parameters for your Internet service provider.
- d. Click **Apply** to save your settings. Click the Test button to verify you have Internet access.

Chapter 4

Optimizing Wireless Connectivity and Security

This chapter describes how to configure the wireless features of your wireless router. In planning your wireless network, you should consider the level of security required. You should also select the physical placement of your firewall in order to maximize the network speed.

The full manual with detailed how to instructions is available via the Documentation link in the configuration utility of the wireless router.

Observe Performance, Placement, and Range Guidelines

The operating distance or range of your wireless connection can vary significantly based on the physical placement of the wireless firewall. The latency, data throughput performance, and notebook power consumption of wireless adapters also vary depending on your configuration choices.



Note: Failure to follow these guidelines can result in significant performance degradation or inability to wirelessly connect to the router. For complete range/performance specifications, please see [Appendix A, “Technical Specifications.”](#)

For best results, place your firewall:

- Near the center of the area in which your computers will operate.
- In an elevated location such as a high shelf where the wirelessly connected computers have line-of-sight access (even if through walls).
- Away from sources of interference, such as computers, microwaves, and 2.4 GHz cordless phones.
- Away from large metal surfaces.
- Put the antenna in a vertical position for best side-to-side coverage. Put the antenna in a horizontal position for best up-and-down coverage.

The time it takes to establish a wireless connection can vary depending on both your security settings and placement. WEP or WPA connections can take slightly longer to establish.

Implement Appropriate Wireless Security



Note: Indoors, computers can connect over 802.11b/g wireless networks at ranges of up to 300 feet. Such distances can allow for others outside of your immediate area to access your network.

Unlike wired network data, your wireless data transmissions can be received well beyond your walls by anyone with a compatible adapter. For this reason, use the security features of your wireless equipment. The wireless router provides highly effective security features which are covered in detail in this chapter. Deploy the security features appropriate to your needs.

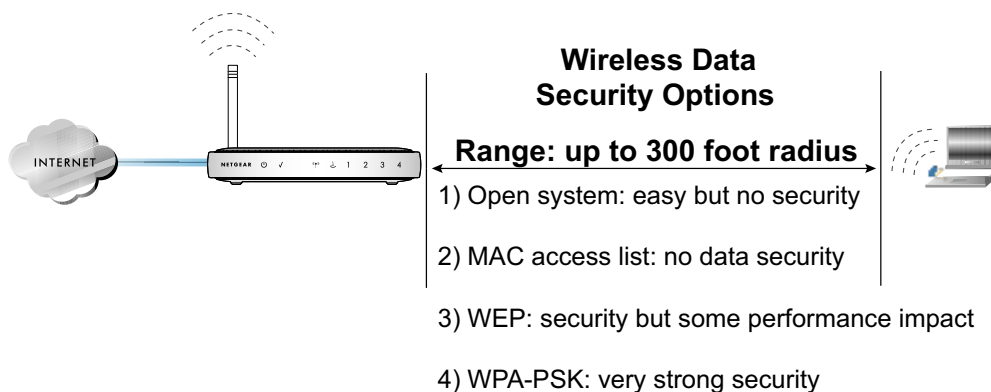

Figure 4-1: wireless router wireless data security options

There are several ways you can enhance the security of your wireless network.

- **Restrict Access Based on MAC Address.** You can restrict access to only trusted computers so that unknown computers cannot wirelessly connect to the wireless router. MAC address filtering adds an obstacle against unwanted access to your network, but the data broadcast over the wireless link is fully exposed.
- **Turn Off the Broadcast of the Wireless Network Name SSID.** If you disable broadcast of the SSID, only devices that have the correct SSID can connect. This nullifies the wireless network ‘discovery’ feature of some products such as Windows XP, but the data is still fully exposed to a determined snoop using specialized test equipment like wireless sniffers.
- **WEP.** Wired Equivalent Privacy (WEP) data encryption provides data security. WEP Shared Key authentication and WEP data encryption will block all but the most determined eavesdropper.

- **WPA-PSK.** Wi-Fi Protected Access (WPA) data encryption provides strong data security. WPA-PSK will block eavesdropping. Because this is a new standard, wireless device driver and software availability may be limited.
- **Turn Off the Wired LAN.** If you disable the wireless LAN, wireless devices cannot communicate with the router at all. You might choose to turn off the wireless the LAN when you are away and the others in the household all use wired connections.

Understanding Wireless Settings

To configure the Wireless settings of your firewall, click the Wireless link in the main menu of the browser interface.

- **Name (SSID).** The SSID is also known as the wireless network name. Enter a value of up to 32 alphanumeric characters. In a setting where there is more than one wireless network, different wireless network names provide a means for separating the traffic. Any device you want to participate in a particular wireless network will need to use this SSID for that network.
- **Region.** This field identifies the region where the wireless router can not be used.
- **Channel.** This field determines which operating frequency will be used. It should not be necessary to change the wireless channel unless you notice interference problems with another nearby access point. The user can use channel 1-11 in USA, 1-13 in Europe.
- **Mode.** This field determines which data communications protocol will be used.
- **Security Options.** These options are the wireless security features you can enable. The table below identifies the various basic wireless security options.
- **Allow Broadcast of Name (SSID).** If you disable broadcast of the SSID, only devices that have the correct SSID can connect. Disabling SSID broadcast nullifies the wireless network 'discovery' feature of some products such as Windows XP.
- **Enable Wireless Access Point.** If you disable the wireless access point, wireless devices cannot connect to the wireless router.
- **Wireless Card Access List.** When the Trusted PCs Only radio button is selected, the wireless router checks the MAC address of the wireless station and only allows connections to computers identified on the trusted computers list.

Table 4-1. Basic Wireless Security Options

Field	Description
Automatic	No wireless security.
WEP	<p>WEP offers the following options:</p> <ul style="list-style-type: none">• Open System With Open Network Authentication and 64- or 128-bit WEP Data Encryption, the wireless router <i>does</i> perform 64- or 128-bit data encryption but <i>does not</i> perform any authentication.• Shared Key Shared Key authentication encrypts the SSID and data. Choose the Encryption Strength (64- or 128-bit data encryption). Manually enter the key values or enter a word or group of printable characters in the Passphrase box. Manually entered keys <i>are</i> case sensitive but passphrase characters <i>are not</i> case sensitive. Note: Not all wireless adapter configuration utilities support passphrase key generation.• Auto
WPA-PSK	<p>WPA-Pre-shared Key <i>does</i> perform authentication, uses 128-bit data encryption and dynamically changes the encryption keys making it nearly impossible to circumvent. Enter a word or group of printable characters in the Password Phrase box. These characters <i>are</i> case sensitive.</p> <p>Note: Not all wireless adapter configuration utilities support WPA. Furthermore, client software is required on the client. Windows XP and Windows 2000 with Service Pack 3 do include the client software that supports WPA. Nevertheless, the wireless adapter hardware and driver must also support WPA.</p>

Information to Gather Before Changing Basic Wireless Settings

Before customizing your wireless settings, print this form and record the following information.

- **802.11g Wireless Network Name (SSID):** _____

The SSID, identifies the wireless network. You can use up to 32 alphanumeric characters. The SSID *is* case sensitive. The SSID in the wireless adapter card must match the SSID of the wireless router. In some configuration utilities (such as in Windows XP), the term “wireless network name” is used instead of SSID.

- **If WEP Authentication is Used.** Circle one: **Open System, Shared Key, or Auto.**

Note: If you select Shared Key, the other devices in the network will not connect unless they are set to Shared Key as well and are configured with the correct key.

- **WEP Encryption key size.** Choose one: **64-bit** or **128-bit**. Again, the encryption key size must be the same for the wireless adapters and the wireless router.
- **Data Encryption (WEP) Keys.** There are two methods for creating WEP data encryption keys. Whichever method you use, record the key values in the spaces below.

- **Passphrase method.** _____ These characters *are* case sensitive. Enter a word or group of printable characters and click the Generate Keys button. Not all wireless devices support the passphrase method.
- **Manual method.** These values *are not* case sensitive. For 64-bit WEP, enter 10 hex digits (any combination of 0-9 or a-f). For 128-bit WEP, enter 26 hex digits.

Key 1: _____

Key 2: _____

Key 3: _____

Key 4: _____

- **If WPA-PSK Authentication is Used.**

- **Passphrase:** _____ These characters *are* case sensitive. Enter a word or group of printable characters. When you use WPA-PSK, the other devices in the network will not connect unless they are set to WPA-PSK as well and are configured with the correct Passphrase.

Use the procedures described in the reference manual to configure the wireless router.

Default Factory Settings

When you first receive your wireless router, the default factory settings are shown below. You can restore these defaults with the Factory Default Restore button on the rear panel. After you install the wireless router, use the procedures below to customize any of the settings to better meet your networking needs.

WIRELESS FEATURE	DEFAULT SETTING
Wireless Access Point	Enabled
Wireless Access List (MAC Filtering)	All wireless stations allowed
SSID broadcast	Enabled
Network Name (SSID)	NETGEAR
WPA and WEP Security	Disabled

Warning: The Network Name (SSID) and passphrase are case sensitive. Typing nETgear for the SSID will not work.

Chapter 5

Doing Basic Router Housekeeping

This chapter describes how to use some of the maintenance features of your Wireless Router. These features can be found by clicking on the Maintenance heading in the Main Menu of the browser interface. Other maintenance features not presented in this chapter can be found accessed via links in the browser interface of the wireless router to the documentation and in the help screens.

Changing the Administrator Password



Note: Before changing the wireless router password, follow the instructions under “[Configuration File Management](#)” on page 5-2 to save your configuration settings. If you forget the new password, you will have to reset the wireless router back to the factory defaults to be able to log in using the default password of password. This means you will have to restore all the wireless router configuration settings. If you ever have to reset the wireless router back to the factory defaults, you can restore your settings from the backup configuration file.

The default password for the wireless router’s Web Configuration Manager is **password**. Change this password to a more secure password.

From the Main Menu of the browser interface, under the Maintenance heading, select Set Password to bring up the menu shown below.

Change Password

Old password

New password

Repeat new password

Figure 5-1: Set Password menu

To change the password, first enter the old password, then enter the new password twice. Click Apply.

Upgrading the Wireless Router Software

From the Main Menu of the browser interface, under the Maintenance heading, select the Router Upgrade link display the menu shown below.

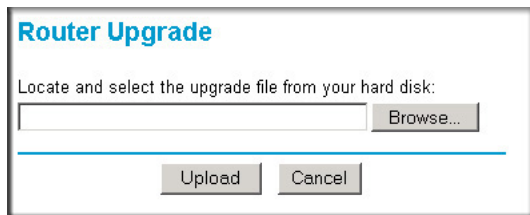

Router Upgrade

Locate and select the upgrade file from your hard disk:

Browse...

Upload Cancel

Figure 5-2: Router Upgrade menu

To upload new firmware:

1. Download and unzip the new software file from NETGEAR.
2. In the Router Upgrade menu, click the Browse button and browse to the location of the upgrade file
3. Click Upload.

Note: When uploading software to the wireless router, it is important not to interrupt the Web browser by closing the window, clicking a link, or loading a new page. If the browser is interrupted, it may corrupt the software. When the upload is complete, your wireless router will automatically restart. The upgrade process will typically take about one minute.

In some cases, you may need to reconfigure the wireless router after upgrading.

Chapter 6

Troubleshooting Common Problems

This chapter gives information about troubleshooting your Wireless Router. After each problem description, instructions are provided to help you diagnose and solve the problem.

Basic Functioning

After you turn on power to the router, the following sequence of events should occur:

1. When power is first applied, verify that the Power light  is on.
2. After approximately 10 seconds, verify that:
 - a. The power light is solid green.
 - b. The LAN port lights are lit for any local ports that are connected.
 - c. The Internet port light is lit.

If a port's light is lit, a link has been established to the connected device. If a LAN port is connected to a 100 Mbps device, verify that the port's light is green. If the port is 10 Mbps, the light will be amber.

If any of these conditions does not occur, refer to the appropriate following section.

Power Light Not On

If the Power and other lights are off when your router is turned on:

- Make sure that the power cord is properly connected to your router and that the power supply adapter is properly connected to a functioning power outlet.
- Check that you are using the [12V DC @ 1.5A output](#) power adapter supplied by NETGEAR for this product.

If the error persists, you have a hardware problem and should contact technical support.

Lights Never Turn Off

When the router is turned on, the lights turn on for about 10 seconds and then turn off. If all the lights stay on, there is a fault within the router.

If all lights are still on one minute after power up:

- Cycle the power to see if the router recovers.
- Clear the router's configuration to factory defaults. This will set the router's IP address to 192.168.61.1. This procedure is explained in [“Restoring the Default Configuration and Password” on page 6-7](#).

If the error persists, you might have a hardware problem and should contact technical support.

LAN or Internet (WAN) Port Lights Not On

If either the LAN lights or Internet light do not light when the Ethernet connection is made, check the following:

- Make sure that the Ethernet cable connections are secure at the router and at the hub or workstation.
- Make sure that power is turned on to the connected hub or workstation.
- Be sure you are using the correct cable:
 - When connecting the router's Internet port to a cable or DSL modem, use the cable that was supplied with the cable or DSL modem. This cable could be a standard straight-through Ethernet cable or an Ethernet crossover cable.

Troubleshooting the Web Configuration Interface

If you are unable to access the router's Web Configuration interface from a computer on your local network, check the following:

- Check the Ethernet connection between the computer and the router as described in the previous section.

- Make sure your computer's IP address is on the same subnet as the router. If you are using the default addressing schemes, your computer's address should be in the range of 192.168.61.2 to 192.168.61.253. Refer to [“Verifying TCP/IP Properties” on page C-8](#) or [“Verifying TCP/IP Properties for Macintosh Computers” on page C-19](#) to find your computer's IP address. Follow the instructions in [Appendix C](#) to configure your computer.

Note: If your computer's IP address is shown as 169.254.x.x, the computer is not configured correctly for your network. Recent versions of Windows and MacOS will generate and assign a 169.254.x.x IP address if the computer cannot reach a DHCP server. These auto-generated addresses are in the range of 169.254.x.x. If your IP address is in this range, check the connection from the computer to the router and reboot your computer.

- Make sure your browser has Java, JavaScript, or ActiveX enabled. If you are using Internet Explorer, click Refresh to be sure the Java applet is loaded.
- Try quitting the browser and launching it again.
- Make sure you are using the correct login information. The URL for the router is <http://www.routerlogin.net> or <http://www.routerlogin.com>. The factory default login name is **admin** and the password is **password**, both in lower case letters. Make sure that CAPS LOCK is off when entering this information.

If the router does not save changes you have made in the Web Configuration Interface, check the following:

- When entering configuration settings, be sure to click the APPLY button before moving to another menu or tab, or your changes are lost.
- Click the Refresh or Reload button in the Web browser. The changes may have occurred, but the Web browser may be caching the old configuration.

Troubleshooting the ISP Connection

If your router is unable to access the Internet, you should first determine whether the router is able to obtain a WAN IP address from the ISP. Unless you have been assigned a static IP address, your router must request an IP address from the ISP. You can determine whether the request was successful using the Web Configuration Manager.

To check the WAN IP address:

1. Launch your browser and select an external site such as www.netgear.com
2. Access the Main Menu of the router's configuration at <http://www.routerlogin.net>.

3. Under the Maintenance heading, select Router Status
4. Check that an IP address is shown for the WAN Port
If 0.0.0.0 is shown, your router has not obtained an IP address from your ISP.

If your router is unable to obtain an IP address from the ISP, you may need to force your cable or DSL modem to recognize your new router by performing the following procedure:

1. Turn off power to the cable or DSL modem.
2. Turn off power to your router.
3. Wait five minutes and reapply power to the cable or DSL modem.
4. When the modem's lights indicate that it has reacquired sync with the ISP, reapply power to your router.
5. Then restart your computer.

If your router is still unable to obtain an IP address from the ISP, the problem may be one of the following:

- Your ISP may require a login program.
Ask your ISP whether they require PPP over Ethernet (PPPoE) or some other type of login.
- If your ISP requires a login, you may have incorrectly set the login name and password in the router.
- Your ISP may check for your computer's host name.
Assign the computer Host Name of your ISP account as the Account Name in the Basic Settings menu.
- Your ISP only allows one Ethernet MAC address to connect to Internet, and may check for your computer's MAC address. In this case:
Inform your ISP that you have bought a new network device, and ask them to use the router's MAC address.

OR

Configure your router to spoof your computer's MAC address. This can be done in the Basic Settings menu.

If your router can obtain an IP address, but your computer is unable to load any Web pages from the Internet:

- Your computer may not recognize any DNS server addresses.

A DNS server is a host on the Internet that translates Internet names (such as www addresses) to numeric IP addresses. Typically your ISP will provide the addresses of one or two DNS servers for your use. If you entered a DNS address during the router's configuration, reboot your computer and verify the DNS address as described in [“Install or Verify Windows Networking Components” on page C-9](#). Alternatively, you may configure your computer manually with DNS addresses, as explained in your operating system documentation.

- Your computer may not have the router configured as its TCP/IP gateway.

If your computer obtains its information from the router by DHCP, reboot the computer and verify the gateway address as described in [“Install or Verify Windows Networking Components” on page C-9](#).

Troubleshooting a TCP/IP Network Using a Ping Utility

Most TCP/IP terminal devices and routers contain a ping utility that sends an echo request packet to the designated device. The device then responds with an echo reply. Troubleshooting a TCP/IP network is made very easy by using the ping utility in your computer or workstation.

Testing the LAN Path to Your Router

You can ping the router from your computer to verify that the LAN path to your router is set up correctly.

To ping the router from a running Windows 95 or later:

1. From the Windows toolbar, click on the Start button and select Run.
2. In the field provided, type Ping followed by the IP address of the router, as in this example:

```
ping 192.168.61.1
```

3. Click on OK.

You should see a message like this one:

```
Pinging <IP address> with 32 bytes of data
```

If the path is working, you see this message:

```
Reply from < IP address >: bytes=32 time=NN ms TTL=xxx
```

If the path is not working, you see this message:

```
Request timed out
```

If the path is not functioning correctly, you could have one of the following problems:

- Wrong physical connections
 - Make sure the LAN port LED is on. If the LED is off, follow the instructions in [“LAN or Internet \(WAN\) Port Lights Not On”](#) on page 6-2.
 - Check that the corresponding Link LEDs are on for your network interface card and for the hub ports (if any) that are connected to your workstation and router.
- Wrong network configuration
 - Verify that the Ethernet card driver software and TCP/IP software are both installed and configured on your computer or workstation.
 - Verify that the IP address for your router and your workstation are correct and that the addresses are on the same subnet.

Testing the Path from Your Computer to a Remote Device

After verifying that the LAN path works correctly, test the path from your computer to a remote device. From the Windows run menu, type:

```
PING -n 10 <IP address>
```

where *<IP address>* is the IP address of a remote device such as your ISP's DNS server.

If the path is functioning correctly, replies as in the previous section are displayed. If you do not receive replies:

- Check that your computer has the IP address of your router listed as the default gateway. If the IP configuration of your computer is assigned by DHCP, this information will not be visible in your computer's Network Control Panel. Verify that the IP address of the router is listed as the default gateway as described in [“Install or Verify Windows Networking Components”](#) on page C-9.
- Check to see that the network address of your computer (the portion of the IP address specified by the netmask) is different from the network address of the remote device.
- Check that your cable or DSL modem is connected and functioning.
- If your ISP assigned a host name to your computer, enter that host name as the Account Name in the Basic Settings menu.

- Your ISP could be rejecting the Ethernet MAC addresses of all but one of your computers. Many broadband ISPs restrict access by only allowing traffic from the MAC address of your broadband modem, but some ISPs additionally restrict access to the MAC address of a single computer connected to that modem. If this is the case, you must log in to the router and use the Basic Settings menu to configure your router to “clone” or “spoof” the MAC address from the authorized computer.

Restoring the Default Configuration and Password

This section explains how to restore the factory default configuration settings, changing the router’s administration password to **password**. You can erase the current configuration and restore factory defaults in two ways:

- Use the Erase function of the router (see [“Erasing the Configuration” on page 5-3](#)).
- Use the Default Reset button on the rear panel of the router. Use this method for cases when the administration password or IP address is not known.

To restore the factory default configuration settings without knowing the administration password or IP address, you must use the Default Reset button on the rear panel of the router.

1. Press and hold the Default Reset button until the power light blinks on (about 10 seconds).
2. Release the Default Reset button and wait for the router to reboot.

If the wireless router fails to restart or the power light continues to blink or turns solid amber, the unit may be defective. If the error persists, you might have a hardware problem and should contact technical support.

Appendix A

Technical Specifications

This appendix provides technical specifications for the Wireless Router.

Network Protocol and Standards Compatibility

Data and Routing Protocols: TCP/IP, RIP-1, DHCP
PPP over Ethernet (PPPoE)

Power Adapter

All regions (output): 12V DC @ 1.5A output

Environmental Specifications

Operating temperature: 0° to 40° C (32° to 104° F)

Operating humidity: 90% maximum relative humidity, noncondensing

Electromagnetic Emissions

Meets requirements of: FCC Part 15 Class B

Interface Specifications

The router incorporates Auto Uplink™ technology which eliminates the need for crossover cables.

LAN: 10BASE-T or 100BASE-Tx, RJ-45, autosensing and capable of full-duplex or half-duplex operation.

WAN: 10BASE-T or 100BASE-Tx, RJ-45, autosensing and capable of full-duplex or half-duplex operation.

Wireless

Radio Data Rates 1, 2, 5.5, 6, 9, 12, 18, 24, 36, 48, and 54 Mbps
Auto Rate Sensing

Frequency 2.4Ghz

Data Encoding: 802.11b/g 2.4GHz to 2.5GHz CCK and OFDM Modulation

Maximum Computers Per Wireless Network: Limited by the amount of wireless network traffic generated by each node. Typically up to 30 nodes.

Operating Frequency Ranges: 2.412~2.462 GHz (US)

802.11 Security: 40-bits (also called 64-bits) and 128-bits WEP and WPA

Appendix C

Preparing Your Network

This appendix describes how to prepare your network to connect to the Internet through the Wireless Router and how to verify the readiness of broadband Internet service from an Internet service provider (ISP).



Note: If an ISP technician configured your computer during the installation of a broadband modem, or if you configured it using instructions provided by your ISP, you may need to copy the current configuration information for use in the configuration of your firewall. Write down this information before reconfiguring your computers. Refer to [“Obtaining ISP Configuration Information for Windows Computers”](#) on page C-21 or [“Obtaining ISP Configuration Information for Macintosh Computers”](#) on page C-22 for further information.

What You Need To Use a Router with a Broadband Modem

You need to prepare these three things before you begin:

Cabling and Computer Hardware

To use the wireless router on your network, each computer must have an 802.11g or 802.11b wireless adapter or an installed Ethernet Network Interface Card (NIC) and an Ethernet cable. If the computer will connect to your network using an Ethernet NIC at 100 Mbps, you must use a Category 5 (Cat 5) cable such as the one provided with your router. For an explanation of Ethernet cabling, see [“Ethernet Cabling”](#) on page B-11. The cable or DSL broadband modem must provide a standard 10 Mbps (10BASE-T) or 100 Mbps (100BASE-Tx) Ethernet interface.

Computer Network Configuration Requirements

The wireless router includes a built-in Web Configuration Manager. To access the configuration menus on the wireless router, you must use a Java-enabled Web browser program which supports HTTP uploads such as Microsoft Internet Explorer or Netscape Navigator. Use Internet Explorer or Netscape Navigator 4.0 or above.

For the initial setup of your router, you will need to connect a computer to the router. This computer has to be set to automatically get its TCP/IP configuration from the router via DHCP.

Note: For help with DHCP configuration, please use the Windows TCP/IP Configuration Tutorials on the *NETGEAR Wireless Router Setup CD*, or in this appendix.

Internet Configuration Requirements

Depending on how your Internet service set up your account, you may need one or more of these configuration parameters to connect your router to the Internet:

- Host and Domain Names
- ISP Login Name and Password
- ISP Domain Name Server (DNS) Addresses
- Fixed IP Address which is also known as Static IP Address

Where Do I Get the Internet Configuration Parameters?

There are several ways you can gather the required Internet connection information.

- Your Internet service provides all the information needed to connect to the Internet. If you cannot locate this information, you can ask your Internet service to provide it or you can try one of the options below.
- If you have a computer already connected using the Internet, you can gather the configuration information from that computer.
 - For Windows 95/98/ME, open the Network control panel, select the TCP/IP entry for the Ethernet adapter, and click Properties. Record all the settings for each tab page.
 - For Windows 2000/XP, open the Local Area Network Connection, select the TCP/IP entry for the Ethernet adapter, and click Properties. Record all the settings for each tab page.
 - For Macintosh computers, record the settings in the TCP/IP or Network control panel.
- You may also refer to the *NETGEAR Wireless Router Setup CD* for the NETGEAR Router ISP Guide which provides Internet connection information for many ISPs.

Once you locate your Internet configuration parameters, you may want to record them on the page below.

Record Your Internet Connection Information

Print this page. Fill in the configuration parameters from your Internet Service Provider (ISP).

ISP Login Name: The login name and password are case sensitive and must be entered exactly as given by your ISP. Some ISPs use your full e-mail address as the login name. The Service Name is not required by all ISPs. If you connect using a login name and password, enter the following:

Login Name: _____

Password: _____

Service Name: _____

Fixed or Static IP Address: If you have a static IP address, record the following information. For example, 169.254.141.148 could be a valid IP address.

Fixed or Static Internet IP Address: _____

Gateway IP Address: _____

Subnet Mask: _____

ISP DNS Server Addresses: If you were given DNS server addresses, fill in the following:

Primary DNS Server IP Address: _____

Secondary DNS Server IP Address: _____

Host and Domain Names: Some ISPs use a specific host or domain name like **CCA7324-A** or **home**. If you haven't been given host or domain names, you can use the following examples as a guide:

- If your main e-mail account with your ISP is **aaa@yyy.com**, then use **aaa** as your host name. Your ISP might call this your account, user, host, computer, or system name.
- If your ISP's mail server is **mail.xxx.yyy.com**, then use **xxx.yyy.com** as the domain name.

ISP Host Name: _____ ISP Domain Name: _____

For Wireless Access: See the configuration worksheet at [“Information to Gather Before Changing Basic Wireless Settings”](#) on page 4-5.

Preparing Your Computers for TCP/IP Networking

Computers access the Internet using a protocol called TCP/IP (Transmission Control Protocol/Internet Protocol). Each computer on your network must have TCP/IP installed and selected as its networking protocol. If a Network Interface Card (NIC) is already installed in your computer, then TCP/IP is probably already installed as well.

Most operating systems include the software components you need for networking with TCP/IP:

- Windows® 95 or later includes the software components for establishing a TCP/IP network.
- Windows 3.1 does not include a TCP/IP component. You need to purchase a third-party TCP/IP application package such as NetManage Chameleon.
- Macintosh Operating System 7 or later includes the software components for establishing a TCP/IP network.
- All versions of UNIX or Linux include TCP/IP components. Follow the instructions provided with your operating system or networking software to install TCP/IP on your computer.

In your IP network, each computer and the firewall must be assigned a unique IP addresses. Each computer must also have certain other IP configuration information such as a subnet mask (netmask), a domain name server (DNS) address, and a default gateway address. In most cases, you should install TCP/IP so that the computer obtains its specific network configuration information automatically from a DHCP server during bootup. For a detailed explanation of the meaning and purpose of these configuration items, refer to “[Appendix B, “Network, Routing, and Firewall Basics.”](#)”

The wireless router is shipped preconfigured as a DHCP server. The firewall assigns the following TCP/IP configuration information automatically when the PCs are rebooted:

- PC or workstation IP addresses—192.168.61.2 through 192.168.61.253
- Subnet mask—255.255.255.0
- Gateway address (the firewall)—192.168.61.1

These addresses are part of the IETF-designated private address range for use in private networks.

Configuring Windows 95, 98, and Me for TCP/IP Networking

As part of the PC preparation process, you need to manually install and configure TCP/IP on each networked PC. Before starting, locate your Windows CD; you may need to insert it during the TCP/IP installation process.

Install or Verify Windows Networking Components

To install or verify the necessary components for IP networking:

1. On the Windows taskbar, click the Start button, point to Settings, and then click Control Panel.

2. Double-click the Network icon.

The Network window opens, which displays a list of installed components:

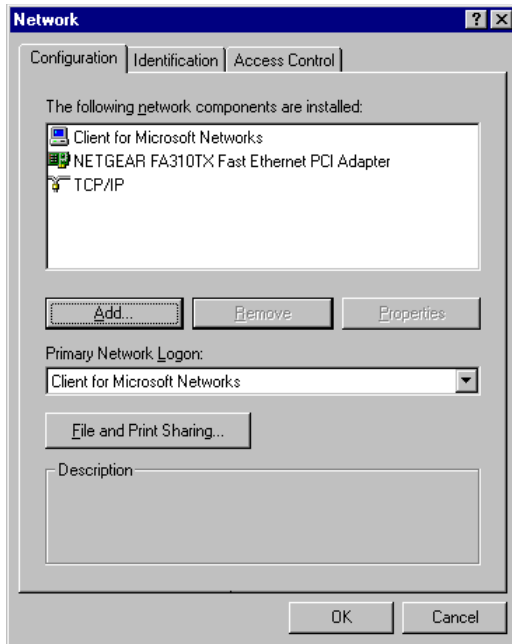

You must have an Ethernet adapter, the TCP/IP protocol, and Client for Microsoft Networks.



Note: It is not necessary to remove any other network components shown in the Network window in order to install the adapter, TCP/IP, or Client for Microsoft Networks.

If you need to install a new adapter, follow these steps:

- a. Click the Add button.
- b. Select Adapter, and then click Add.
- c. Select the manufacturer and model of your Ethernet adapter, and then click OK.

If you need TCP/IP:

- a. Click the Add button.
- b. Select Protocol, and then click Add.

- c. Select Microsoft.
- d. Select TCP/IP, and then click OK.

If you need Client for Microsoft Networks:

- a. Click the Add button.
 - b. Select Client, and then click Add.
 - c. Select Microsoft.
 - d. Select Client for Microsoft Networks, and then click OK.
3. Restart your PC for the changes to take effect.

Enabling DHCP to Automatically Configure TCP/IP Settings in Windows 95B, 98, and Me

After the TCP/IP protocol components are installed, each PC must be assigned specific information about itself and resources that are available on its network. The simplest way to configure this information is to allow the PC to obtain the information from a DHCP server in the network.

You will find there are many similarities in the procedures for different Windows systems when using DHCP to configure TCP/IP.

The following steps will walk you through the configuration process for each of these versions of Windows.

1

Locate your **Network Neighborhood** icon.

- If the Network Neighborhood icon is on the Windows desktop, position your mouse pointer over it and right-click your mouse button.
- If the icon is not on the desktop,
 - Click **Start** on the task bar located at the bottom left of the window.
 - Choose **Settings**, and then **Control Panel**.
 - Locate the **Network Neighborhood** icon and click on it. This will open the Network panel as shown below.

2

Verify the following settings as shown:

- Client for Microsoft Network exists
- Ethernet adapter is present
- TCP/IP is present
- **Primary Network Logon** is set to Windows logon

Click on the **Properties** button. The following TCP/IP Properties window will display.

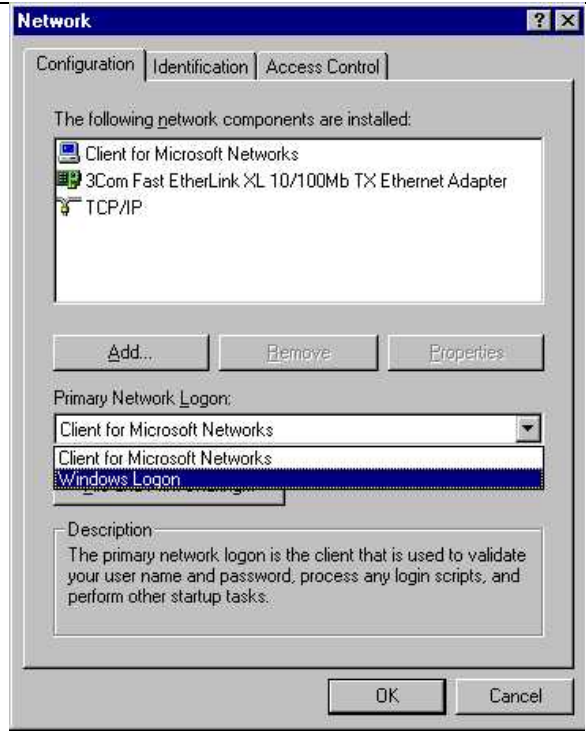

3

- By default, the **IP Address** tab is open on this window.
- Verify the following:
 - **Obtain an IP address automatically** is selected. If not selected, click in the radio button to the left of it to select it. This setting is required to enable the DHCP server to automatically assign an IP address.
 - Click **OK** to continue.

Restart the PC.

Repeat these steps for each PC with this version of Windows on your network.

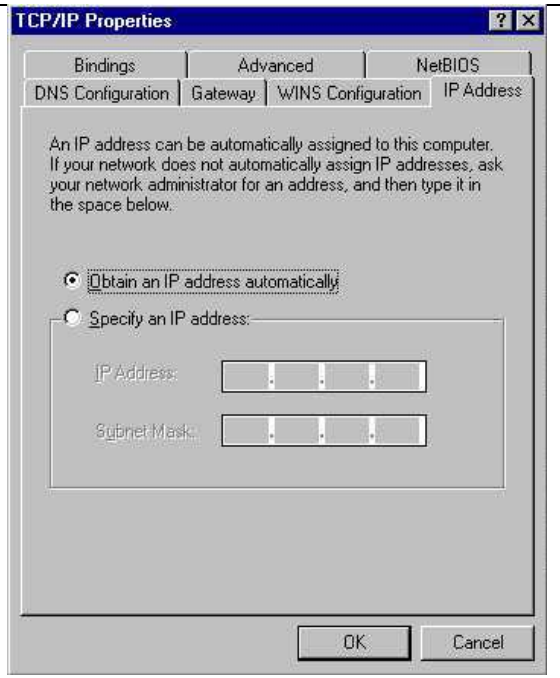

Selecting Windows' Internet Access Method

1. On the Windows taskbar, click the Start button, point to Settings, and then click Control Panel.
2. Double-click the Internet Options icon.
3. Select "I want to set up my Internet connection manually" or "I want to connect through a Local Area Network" and click Next.
4. Select "I want to connect through a Local Area Network" and click Next.
5. Uncheck all boxes in the LAN Internet Configuration screen and click Next.
6. Proceed to the end of the Wizard.

Verifying TCP/IP Properties

After your PC is configured and has rebooted, you can check the TCP/IP configuration using the utility *wiipcfg.exe*:

1. On the Windows taskbar, click the Start button, and then click Run.

2. Type `winiipcfg`, and then click OK.

The IP Configuration window opens, which lists (among other things), your IP address, subnet mask, and default gateway.

3. From the drop-down box, select your Ethernet adapter.

The window is updated to show your settings, which should match the values below if you are using the default TCP/IP settings that NETGEAR recommends for connecting through a router or gateway:

- The IP address is between 192.168.61.2 and 192.168.61.253
- The subnet mask is 255.255.255.0
- The default gateway is 192.168.61.1

Configuring Windows NT4, 2000 or XP for IP Networking

As part of the PC preparation process, you may need to install and configure TCP/IP on each networked PC. Before starting, locate your Windows CD; you may need to insert it during the TCP/IP installation process.

Install or Verify Windows Networking Components

To install or verify the necessary components for IP networking:

1. On the Windows taskbar, click the Start button, point to Settings, and then click Control Panel.
2. Double-click the Network and Dialup Connections icon.
3. If an Ethernet adapter is present in your PC, you should see an entry for Local Area Connection. Double-click that entry.
4. Select Properties.
5. Verify that 'Client for Microsoft Networks' and 'Internet Protocol (TCP/IP)' are present. If not, select Install and add them.
6. Select 'Internet Protocol (TCP/IP)', click Properties, and verify that "Obtain an IP address automatically is selected.
7. Click OK and close all Network and Dialup Connections windows.
8. Then, restart your PC.

DHCP Configuration of TCP/IP in Windows XP, 2000, or NT4

You will find there are many similarities in the procedures for different Windows systems when using DHCP to configure TCP/IP.

The following steps will walk you through the configuration process for each of these versions of Windows.

DHCP Configuration of TCP/IP in Windows XP

1

Locate your **Network Neighborhood** icon.

- Select **Control Panel** from the Windows XP new Start Menu.
- Select the **Network Connections** icon on the Control Panel. This will take you to the next step.

2

- Now the Network Connection window displays.

The Connections List that shows all the network connections set up on the PC, located to the right of the window.

- Right-click on the **Connection** you will use and choose **Status**.

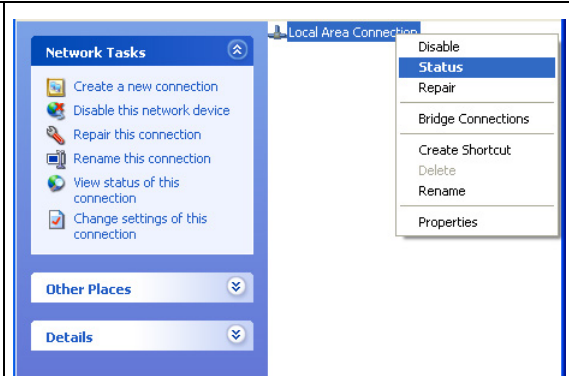

3

- Now you should be at the Local Area Network Connection Status window. This box displays the connection status, duration, speed, and activity statistics.
- Administrator logon access rights are needed to use this window.
- Click the **Properties** button to view details about the connection.

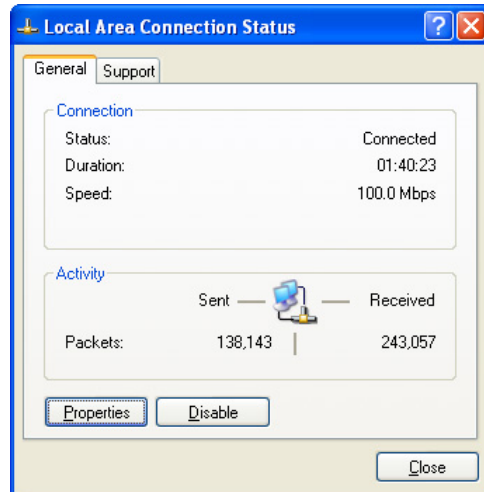

4

- The TCP/IP details are presented on the Support tab page.
- Select **Internet Protocol**, and click **Properties** to view the configuration information.

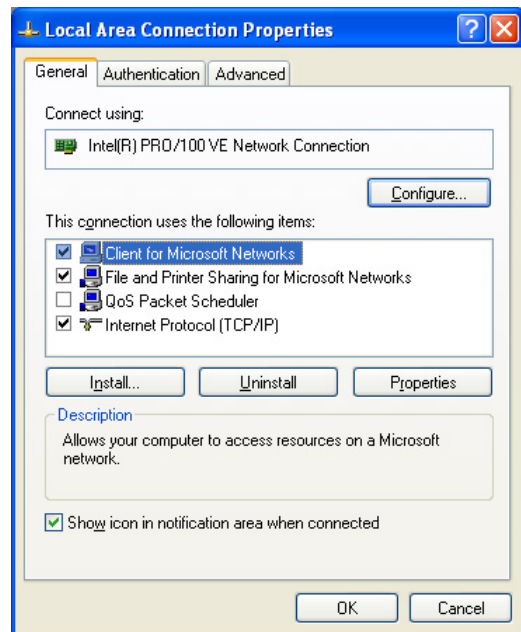

5

- Verify that the **Obtain an IP address automatically** radio button is selected.
- Verify that **Obtain DNS server address automatically** radio button is selected.
- Click the **OK** button.

This completes the DHCP configuration of TCP/IP in Windows XP.

Repeat these steps for each PC with this version of Windows on your network.

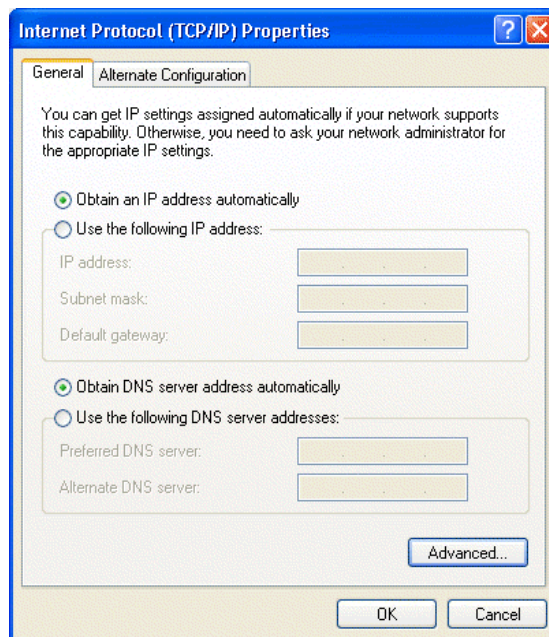

DHCP Configuration of TCP/IP in Windows 2000

Once again, after you have installed the network card, TCP/IP for Windows 2000 is configured. TCP/IP should be added by default and set to DHCP without your having to configure it. However, if there are problems, follow these steps to configure TCP/IP with DHCP for Windows 2000.

1

- Click on the **My Network Places** icon on the Windows desktop. This will bring up a window called Network and Dial-up Connections.
- Right click on **Local Area Connection** and select **Properties**.

2

- The **Local Area Connection Properties** dialog box appears.
- Verify that you have the correct Ethernet card selected in the **Connect using:** box.
- Verify that at least the following two items are displayed and selected in the box of “Components checked are used by this connection:”
 - Client for Microsoft Networks and
 - Internet Protocol (TCP/IP)
- Click **OK**.

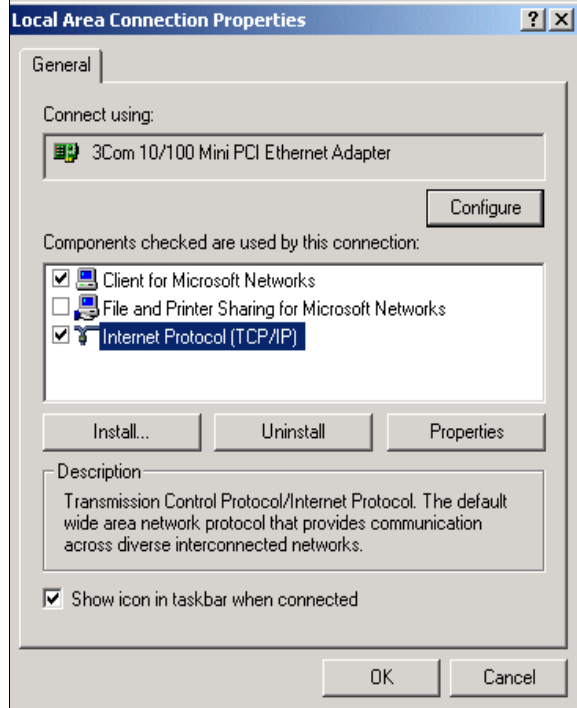

3

- With Internet Protocol (TCP/IP) selected, click on **Properties** to open the Internet Protocol (TCP/IP) Properties dialogue box.
- Verify that
 - **Obtain an IP address automatically** is selected.
 - **Obtain DNS server address automatically** is selected.
- Click **OK** to return to Local Area Connection Properties.

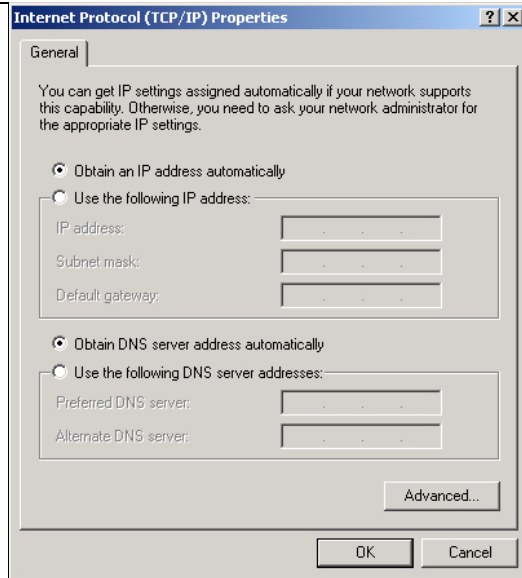

4

- Click **OK** again to complete the configuration process for Windows 2000.

Restart the PC.

Repeat these steps for each PC with this version of Windows on your network.

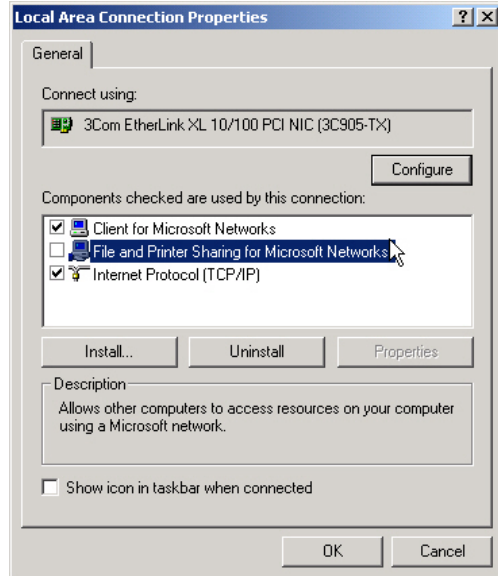

DHCP Configuration of TCP/IP in Windows NT4

Once you have installed the network card, you need to configure the TCP/IP environment for Windows NT 4.0. Follow this procedure to configure TCP/IP with DHCP in Windows NT 4.0.

1

- Choose **Settings** from the Start Menu, and then select **Control Panel**. This will display Control Panel window.

2

- Double-click the **Network** icon in the Control Panel window.
The Network panel will display.
- Select the **Protocols** tab to continue.

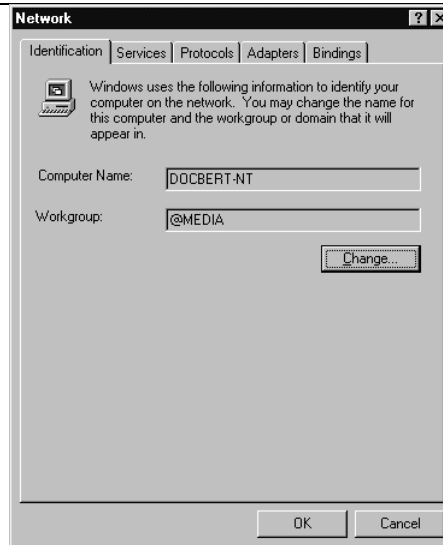

3

- Highlight the **TCP/IP Protocol** in the **Network Protocols** box, and click on the **Properties** button.

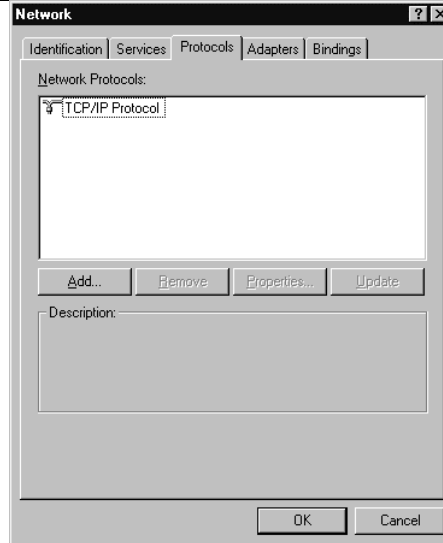

4

- The **TCP/IP Properties** dialog box now displays.
- Click the **IP Address** tab.
- Select the radio button marked **Obtain an IP address from a DHCP server**.
- Click **OK**. This completes the configuration of TCP/IP in Windows NT.

Restart the PC.

Repeat these steps for each PC with this version of Windows on your network.

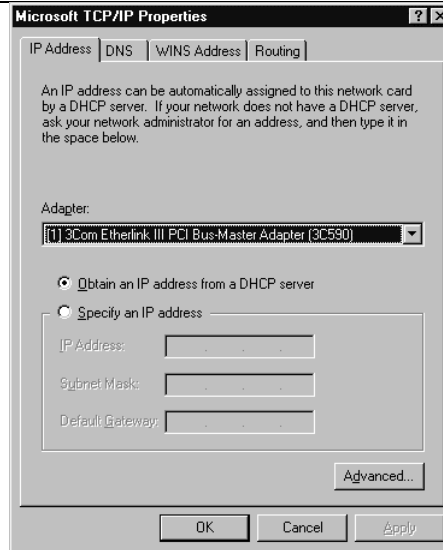

Verifying TCP/IP Properties for Windows XP, 2000, and NT4

To check your PC's TCP/IP configuration:

1. On the Windows taskbar, click the Start button, and then click Run.

The Run window opens.

2. Type `cmd` and then click OK.

A command window opens

3. Type `ipconfig /all`

Your IP Configuration information will be listed, and should match the values below if you are using the default TCP/IP settings that NETGEAR recommends for connecting through a router or gateway:

- The IP address is between 192.168.61.2 and 192.168.61.254
- The subnet mask is 255.255.255.0

- The default gateway is 192.168.61.1

4. Type `exit`

Configuring the Macintosh for TCP/IP Networking

Beginning with Macintosh Operating System 7, TCP/IP is already installed on the Macintosh. On each networked Macintosh, you will need to configure TCP/IP to use DHCP.

MacOS 8.6 or 9.x

1. From the Apple menu, select Control Panels, then TCP/IP.

The TCP/IP Control Panel opens:

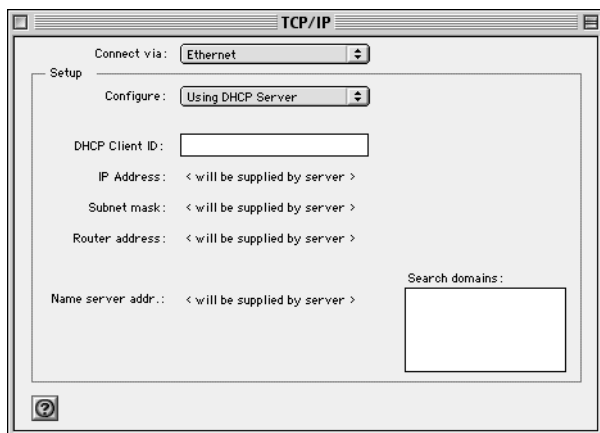

2. From the “Connect via” box, select your Macintosh’s Ethernet interface.

3. From the “Configure” box, select Using DHCP Server.

You can leave the DHCP Client ID box empty.

4. Close the TCP/IP Control Panel.

5. Repeat this for each Macintosh on your network.

MacOS X

1. From the Apple menu, choose System Preferences, then Network.

2. If not already selected, select Built-in Ethernet in the Configure list.
3. If not already selected, Select Using DHCP in the TCP/IP tab.
4. Click Save.

Verifying TCP/IP Properties for Macintosh Computers

After your Macintosh is configured and has rebooted, you can check the TCP/IP configuration by returning to the TCP/IP Control Panel. From the Apple menu, select Control Panels, then TCP/IP.

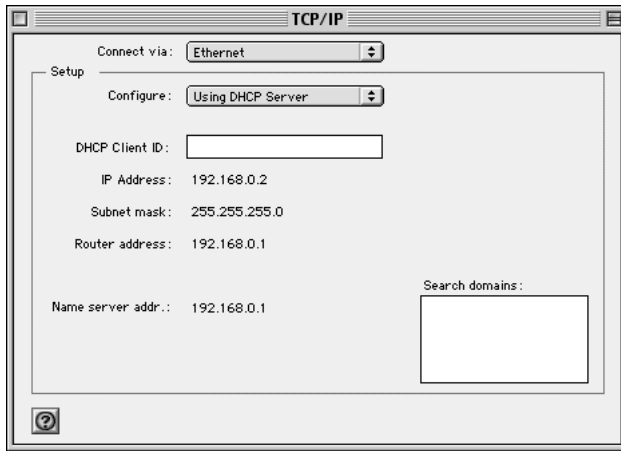

The panel is updated to show your settings, which should match the values below if you are using the default TCP/IP settings that NETGEAR recommends:

- The IP Address is between 192.168.61.2 and 192.168.61.254
- The Subnet mask is 255.255.255.0
- The Router address is 192.168.61.1

If you do not see these values, you may need to restart your Macintosh or you may need to switch the “Configure” setting to a different option, then back again to “Using DHCP Server”.

Verifying the Readiness of Your Internet Account

For broadband access to the Internet, you need to contract with an Internet service provider (ISP) for a single-user Internet access account using a cable modem or DSL modem. This modem must be a separate physical box (not a card) and must provide an Ethernet port intended for connection to a Network Interface Card (NIC) in a computer. Your firewall does not support a USB-connected broadband modem.

For a single-user Internet account, your ISP supplies TCP/IP configuration information for one computer. With a typical account, much of the configuration information is dynamically assigned when your PC is first booted up while connected to the ISP, and you will not need to know that dynamic information.

In order to share the Internet connection among several computers, your firewall takes the place of the single PC, and you need to configure it with the TCP/IP information that the single PC would normally use. When the firewall's Internet port is connected to the broadband modem, the firewall appears to be a single PC to the ISP. The firewall then allows the PCs on the local network to masquerade as the single PC to access the Internet through the broadband modem. The method used by the firewall to accomplish this is called Network Address Translation (NAT) or IP masquerading.

Are Login Protocols Used?

Some ISPs require a special login protocol, in which you must enter a login name and password in order to access the Internet. If you normally log in to your Internet account by running a program such as WinPOET or EnterNet, then your account uses PPP over Ethernet (PPPoE).

When you configure your router, you will need to enter your login name and password in the router's configuration menus. After your network and firewall are configured, the firewall will perform the login task when needed, and you will no longer need to run the login program from your PC. It is not necessary to uninstall the login program.

What Is Your Configuration Information?

More and more, ISPs are dynamically assigning configuration information. However, if your ISP does not dynamically assign configuration information but instead used fixed configurations, your ISP should have given you the following basic information for your account:

- An IP address and subnet mask
- A gateway IP address, which is the address of the ISP's router
- One or more domain name server (DNS) IP addresses
- Host name and domain suffix

For example, your account's full server names may look like this:

`mail.xxx.yyy.com`

In this example, the domain suffix is `xxx.yyy.com`.

If any of these items are dynamically supplied by the ISP, your firewall automatically acquires them.

If an ISP technician configured your PC during the installation of the broadband modem, or if you configured it using instructions provided by your ISP, you need to copy the configuration information from your PC's Network TCP/IP Properties window or Macintosh TCP/IP Control Panel before reconfiguring your PC for use with the firewall. These procedures are described next.

Obtaining ISP Configuration Information for Windows Computers

As mentioned above, you may need to collect configuration information from your PC so that you can use this information when you configure the wireless router. Following this procedure is only necessary when your ISP does not dynamically supply the account information.

To get the information you need to configure the firewall for Internet access:

1. On the Windows taskbar, click the Start button, point to Settings, and then click Control Panel.
2. Double-click the Network icon.

The Network window opens, which displays a list of installed components.

3. Select TCP/IP, and then click Properties.

The TCP/IP Properties dialog box opens.

4. Select the IP Address tab.

If an IP address and subnet mask are shown, write down the information. If an address is present, your account uses a fixed (static) IP address. If no address is present, your account uses a dynamically-assigned IP address. Click "Obtain an IP address automatically".

5. Select the Gateway tab.

If an IP address appears under Installed Gateways, write down the address. This is the ISP's gateway address. Select the address and then click Remove to remove the gateway address.

6. Select the DNS Configuration tab.

If any DNS server addresses are shown, write down the addresses. If any information appears in the Host or Domain information box, write it down. Click Disable DNS.

7. Click OK to save your changes and close the TCP/IP Properties dialog box.

You are returned to the Network window.

8. Click OK.

9. Reboot your PC at the prompt. You may also be prompted to insert your Windows CD.

Obtaining ISP Configuration Information for Macintosh Computers

As mentioned above, you may need to collect configuration information from your Macintosh so that you can use this information when you configure the wireless router. Following this procedure is only necessary when your ISP does not dynamically supply the account information.

To get the information you need to configure the firewall for Internet access:

1. From the Apple menu, select Control Panels, then TCP/IP.

The TCP/IP Control Panel opens, which displays a list of configuration settings. If the "Configure" setting is "Using DHCP Server", your account uses a dynamically-assigned IP address. In this case, close the Control Panel and skip the rest of this section.

2. If an IP address and subnet mask are shown, write down the information.
3. If an IP address appears under Router address, write down the address. This is the ISP's gateway address.
4. If any Name Server addresses are shown, write down the addresses. These are your ISP's DNS addresses.
5. If any information appears in the Search domains information box, write it down.
6. Change the "Configure" setting to "Using DHCP Server".
7. Close the TCP/IP Control Panel.

Restarting the Network

Once you've set up your computers to work with the firewall, you must reset the network for the devices to be able to communicate correctly. Restart any computer that is connected to the firewall.

After configuring all of your computers for TCP/IP networking and restarting them, and connecting them to the local network of your wireless router, you are ready to access and configure the firewall.

Glossary

Use the list below to find definitions for technical terms used in this manual.

List of Glossary Terms

802.11b

IEEE specification for wireless networking at 11 Mbps using direct-sequence spread-spectrum (DSSS) technology and operating in the unlicensed radio spectrum at 2.5GHz.

802.11g

A soon to be ratified IEEE specification for wireless networking at 54 Mbps using direct-sequence spread-spectrum (DSSS) technology and operating in the unlicensed radio spectrum at 2.5GHz. 802.11g is backwards compatible with 802.11b.

Cat 5

Category 5 unshielded twisted pair (UTP) cabling. An Ethernet network operating at 10 Mbits/second (10BASE-T) will often tolerate low quality cables, but at 100 Mbits/second (10BASE-Tx) the cable must be rated as Category 5, or Cat 5 or Cat V, by the Electronic Industry Association (EIA).

This rating will be printed on the cable jacket. Cat 5 cable contains eight conductors, arranged in four twisted pairs, and terminated with an RJ45 type connector. In addition, there are restrictions on maximum cable length for both 10 and 100 Mbits/second networks.

DHCP

An Ethernet protocol specifying how a centralized DHCP server can assign network configuration information to multiple DHCP clients. The assigned information includes IP addresses, DNS addresses, and gateway (router) addresses.

DNS

Short for Domain Name System (or Service), an Internet service that translates domain names into IP addresses.

Because domain names are alphabetic, they're easier to remember. The Internet however, is really based on IP addresses. Every time you use a domain name, therefore, a DNS service must translate the name into the corresponding IP address. For example, the domain name `www.example.com` might translate to `198.105.232.4`. The DNS system is, in fact, its own network. If one DNS server doesn't know how to translate a particular domain name, it asks another one, and so on, until the correct IP address is returned.

Domain Name

A descriptive name for an address or group of addresses on the Internet. Domain names are of the form of a registered entity name plus one of a number of predefined top level suffixes such as .com, .edu, .uk, etc. For example, in the address mail.NETGEAR.com, mail is a server name and NETGEAR.com is the domain.

DSL

Short for digital subscriber line, but is commonly used in reference to the asymmetric version of this technology (ADSL) that allows data to be sent over existing copper telephone lines at data rates of from 1.5 to 9 Mbps when receiving data (known as the downstream rate) and from 16 to 640 Kbps when sending data (known as the upstream rate).

ADSL requires a special ADSL modem. ADSL is growing in popularity as more areas around the world gain access.

Dynamic Host Configuration Protocol

DHCP. An Ethernet protocol specifying how a centralized DHCP server can assign network configuration information to multiple DHCP clients. The assigned information includes IP addresses, DNS addresses, and gateway (router) addresses.

Gateway

A local device, usually a router, that connects hosts on a local network to other networks.

IP

Internet Protocol is the main internetworking protocol used in the Internet. Used in conjunction with the Transfer Control Protocol (TCP) to form TCP/IP.

IP Address

A four-byte number uniquely defining each host on the Internet, usually written in dotted-decimal notation with periods separating the bytes (for example, 134.177.244.57).

Ranges of addresses are assigned by Internic, an organization formed for this purpose.

ISP

Internet service provider.

Internet Protocol

The main internetworking protocol used in the Internet. Used in conjunction with the Transfer Control Protocol (TCP) to form TCP/IP.

local area network

LAN. A communications network serving users within a limited area, such as one floor of a building.

A LAN typically connects multiple personal computers and shared network devices such as storage and printers. Although many technologies exist to implement a LAN, Ethernet is the most common for connecting personal computers.

MAC address

The Media Access Control address is a unique 48-bit hardware address assigned to every network interface card. Usually written in the form 01:23:45:67:89:ab.

Mbps

Megabits per second.

Point-to-Point Protocol

PPP. A protocol allowing a computer using TCP/IP to connect directly to the Internet.

PPPoE

PPPoE. PPP over Ethernet is a protocol for connecting remote hosts to the Internet over an always-on connection by simulating a dial-up connection.

PPTP

Point-to-Point Tunneling Protocol. A method for establishing a virtual private network (VPN) by embedding Microsoft's network protocol into Internet packets.

router

A device that forwards data between networks. An IP router forwards data based on IP source and destination addresses.

SSID

A Service Set Identification is a thirty-two character (maximum) alphanumeric key identifying a wireless local area network. For the wireless devices in a network to communicate with each other, all devices must be configured with the same SSID.

This is typically the configuration parameter for a wireless PC card. It corresponds to the ESSID in the wireless Access Point and to the wireless network name. *See also* Wireless Network Name and ESSID.

Subnet Mask

A mask used to determine what subnet an IP address belongs to. Subnetting enables a network administrator to further divide an IP address into two or more subnets.

An IP address has two components, the network address and the host address. For example, consider the IP address 150.215.017.009. Assuming this is part of a Class B network, the first two numbers (150.215) represent the Class B network address, and the second two numbers (017.009) identify a particular host on this network.

Subnetting enables the network administrator to further divide the host part of the address into two or more subnets. In this case, a part of the host address is reserved to identify the particular subnet. This is easier to see if we show the IP address in binary format. The full address is: 10010110.11010111.00010001.00001001

The Class B network part is: 10010110.11010111

and the host address is 00010001.00001001

If this network is divided into 14 subnets, however, then the first 4 bits of the host address (0001) are reserved for identifying the subnet.

The subnet mask is the network address plus the bits reserved for identifying the subnetwork. (By convention, the bits for the network address are all set to 1, though it would also work if the bits were set exactly as in the network address.) In this case, therefore, the subnet mask would be 11111111.11111111.11110000.00000000. It's called a mask because it can be used to identify the subnet to which an IP address belongs by performing a bitwise AND operation on the mask and the IP address. The result is the subnetwork address: Subnet Mask 255.255.240.000 11111111.11111111.11110000.00000000
IP Address 150.215.017.009 10010110.11010111.00010001.00001001
Subnet Address 150.215.016.000 10010110.11010111.00010000.00000000

The subnet address, therefore, is 150.215.016.000.

TCP/IP

The main internetworking protocols used in the Internet. The Internet Protocol (IP) used in conjunction with the Transfer Control Protocol (TCP) form TCP/IP.

WAN

Wide Area Network. A long distance link used to extend or connect remotely located local area networks. The Internet is a large WAN.

WEP

Wired Equivalent Privacy is a data encryption protocol for 802.11b wireless networks. All wireless nodes and access points on the network are configured with a 64-bit or 128-bit Shared Key for data encryption.

Wi-Fi

A trade name for the 802.11b wireless networking standard, given by the Wireless Ethernet Compatibility Alliance (WECA, see <http://www.wi-fi.net>), an industry standards group promoting interoperability among 802.11b devices.

Wireless Network Name (SSID)

Wireless Network Name (SSID) is the name assigned to a wireless network. This is the same as the SSID or ESSID configuration parameter.

WPA

Wi-Fi Protected Access (WPA) is a specification of standards-based, interoperable security enhancements that increase the level of data protection and access control for existing and future wireless LAN systems.