

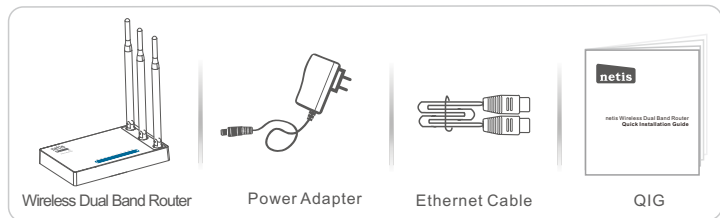

netis Wireless Dual Band Router
Quick Installation Guide



1.Package Contents



*This QIG is for all netis wireless dual band routers, including models- WF2471, WF2471D, WF2710, WF2710D, WF2722, WF2722D, WF2780, WF2780D, WF2891, WF2891D, etc.

* The product model shown in this QIG is WF2710, as an example.

2.Hardware Connection

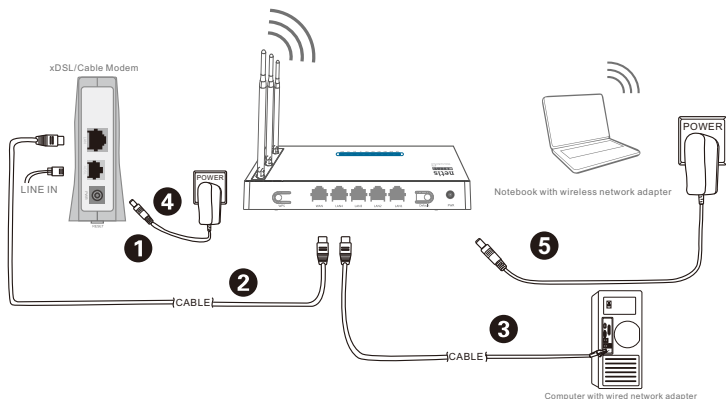

2.1. Power off your Modem.

2.2. Connect the **WAN** port on netis Router to the Modem's **LAN** port with an Ethernet cable.

2.3. Connect your computer to one of the **LAN** ports on netis Router with an Ethernet cable.

2.4. Power on your Modem.

2.5. Plug the provided Power Adapter into the **PWR** jack of netis Router and the other end to a standard electrical socket. Then wait for one minute.

3. Configure the Router via Web Management Page

3.1. Set the IP address of the wired network adapter on your computer as “Automatic” or “DHCP”.

For Windows 8/ 7/Vista

- 1) Go to “Settings” (Win 8)/ “Start” (Win 7/Vista)> “Control Panel”.
- 2) Left-click on “Network and Internet”> “Network and Sharing Center”> “Change adapter settings” (Win 8/7)/ “Manage network connections” (Win Vista).
- 3) Right-click on “Local Area Connection” and left-click on “Properties”.
- 4) Double-click on “Internet Protocol Version 4 (TCP/IPv4)”.
- 5) Select “Obtain an IP address automatically” and “Obtain DNS server address automatically” then left-click on “OK”.

For Windows XP/2000

- 1) Go to “Start”> “Control Panel”.
- 2) Left-click on “Network and Internet Connections”> “Network Connections”.
- 3) Right-click on “Local Area Connection” and left-click on “Properties”.
- 4) Double-click on “Internet Protocol (TCP/IP)”.
- 5) Select “Obtain an IP address automatically” and “Obtain DNS server address automatically” then left-click on “OK”.

For MAC OS

- 1) Click on the “Apple” menu> “System Preferences”.
- 2) Click on the “Network” icon.
- 3) Click on “Ethernet” in the left side box and click on “Advanced” in the lower right corner.
- 4) In the top options, select “TCP/IP”.
- 5) In the pull-down menu next to “Configure Ipv4”, select “Using DHCP”.
- 6) Click “OK” then “Apply”.

3.2. Open your browser and type **192.168.1.1** in the address field to visit router’s web management page.

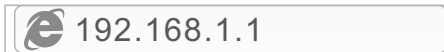

3. 3. Select the language as you need on the top box, default is in English.

1) In “**Quick Setup**” page, select your **Internet Connection Type**.

If “**DHCP (Cable Modem)**” is selected, the router will automatically receive the IP parameters from your ISP (Internet Service Provider).

If “**Static IP**” is selected, please enter the **IP Address/Subnet Mask/Default Gateway/DNS Servers** given by your ISP.

If “**PPPoE**” is selected, please enter the **Username** and **Password** given by your ISP.

2) Under **Wireless Setup**, configure your wireless network name (SSID) and password.

3) Left-click on “**Save**” to make your settings take effect.

The screenshot shows the netis router's configuration interface. At the top, there's a language dropdown menu set to 'English' and an 'Advanced' button with a gear icon. The main heading is 'Quick Setup'. Below this, there are two main sections: 'Internet Connection Type' and 'Wireless Setup'. In the 'Internet Connection Type' section, there's a blue cloud icon labeled 'internet' and four radio button options: 'DHCP' (selected), 'Static IP', 'PPPoE', and 'Other'. The 'Wireless Setup' section features a green wireless signal icon labeled 'Wireless' and two identical configuration blocks for 2.4G and 5G networks. Each block has a text input for SSID (both set to 'netis_2.4G_30E6CE' and 'netis_5G_30E6CE'), a security dropdown (both set to 'Enable'), and a text input for password (both set to 'password'). A note below each password field says '(Please enter 8-63 characters.)'. At the bottom of the form is a 'Save' button.

Tip 1:

IP address: 192.168.1.1

2.4G default SSID: netis_2.4G_XXXXXX 5G default SSID: netis_5G_XXXXXX

Default wireless password: password

(XXXXXX: Last 6 digits of LAN MAC Address)

Tip 2:

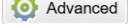
You can click on  button on the top for other Internet connection types and further settings.

4. Troubleshooting

Q How do I restore my netis Router's configuration to its default settings?

A With the router powered on, use a pin to press and hold the **Default** button on the rear panel for 8 to 10 seconds before releasing it. The router will reboot and all configurations are back to factory default.

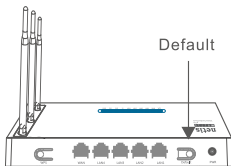

Q What can I do if my Internet cannot be accessed?

A 1) Check to verify the hardware connections are correct. Please refer to the **“Hardware Connection”** step.
 2) Login to netis Router's web management page and ensure that you set the correct Internet Connection Type. For cable modem users, please configure **“MAC Clone”** additionally.

On the left-side menu, left-click on  **Advanced** > **“Network”**> **“WAN”**. And in the middle page, left-click on **“Advanced”**> **“MAC Clone”** and then **“Save”** it.

MAC Address : 08:10:76:3a:70:fb

MAC Clone

Default MAC

- 3) Reboot the modem first and then netis Router. Wait for one minute before you check the Internet again.
 4) If Internet access is not available, please connect your computer directly to your modem and try the Internet again.
 If the Internet is still not working, please contact your ISP for further help.

Technical Support:

USA/ Canada:

Toll Free: +1 866 71 network (+1 866 716 3896)

E-mail: usa_support@netis-systems.com

Other Regions:

E-mail: support@netis-systems.com

NETIS SYSTEMS CO., LTD.

www.netis-systems.com

MADE IN CHINA



Router Inalámbrico de Doble Banda netis
Guía de Instalación Rápida



1. Contenido del Empaque

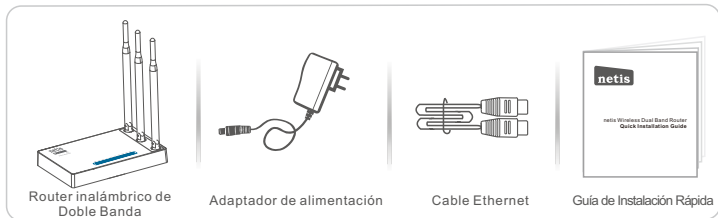

*Esta guía de instalación rápida es para todos los router inalámbricos netis de doble banda, incluidos los modelos- WF2471, WF2471D, WF2710, WF2710D, WF2722, WF2722D, WF2780, WF2780D, WF2891, WF2891D, etc.

*El ejemplo del modelo del producto que se muestra en esta Guía de Instalación Rápida es WF2710.

2. Conexión del Hardware

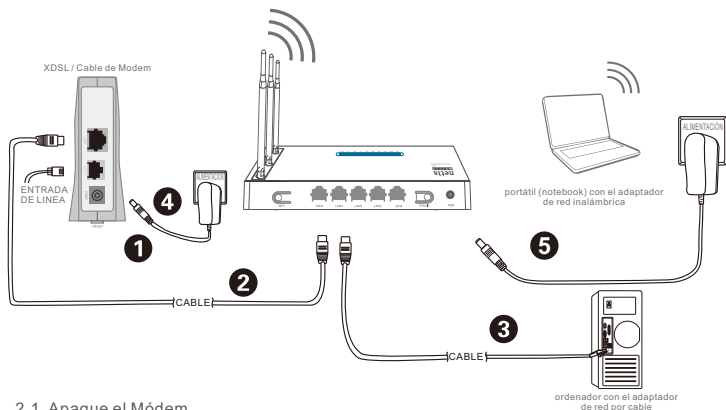

- 2.1. Apague el Módem.
- 2.2. Conecte el puerto de **red de área amplia (WAN)** del Router netis al puerto de **red de área local (LAN)** del módem con un cable Ethernet.
- 2.3. Conecte su ordenador a uno de los puertos de **red de área local (LAN)** del router netis con un cable Ethernet.
- 2.4. Encienda el Módem.
- 2.5. Conecte el adaptador de alimentación suministrado en el conector de **alimentación (PWR)** del router netis y el otro extremo a una toma de corriente estándar. Luego, espere durante un minuto.

3. Configurar el Módem Router a través de la Página Web de Administración

- 3.1. Configure la dirección IP del adaptador de red por cable en su ordenador como **“Automático”** o **“Protocolo de configuración dinámica del host (DHCP)”**.

Para Windows 8/ 7/Vista

- 1) Vaya a **“Configuración”** (Windows 8) / **“Inicio”** (Windows 7/Vista) > **“Panel de control”**.
- 2) Haga clic izquierdo en **“Redes e internet”** > **“Redes y Recursos compartidos”** **“Cambio de configuración del adaptador”** > (Windows 8/7) / **“Administrador de conexiones de red”** (Windows Vista).
- 3) Haga clic derecho sobre **“Conexión de área local”** y haga clic sobre **“Propiedades”**.
- 4) Haga doble clic en **“Protocolo de Internet Versión 4 (TCP/IPv4)”**.
- 5) Seleccione **“Obtener una dirección IP automáticamente”** y **“Obtener la dirección del servidor de sistema de nombre de dominio (DNS) automáticamente”** y luego haga clic sobre **“OK”**.

Para Windows XP/2000

- 1) Vaya a **“inicio”** > **“Panel de Control”**.
- 2) Haga clic izquierdo en **“Redes y conexiones de internet”**.
- 3) Haga clic derecho sobre **“Conexión de área local”** y haga clic sobre **“Propiedades”**.
- 4) Haga doble clic en **“Protocolo de Internet (TCP/IP)”**.
- 5) Seleccione **“Obtener una dirección IP automáticamente”** y **“Obtener la dirección del servidor de sistema de nombre de dominio (DNS) automáticamente”** y luego haga clic sobre **“OK”**.

Para MAC OS

- 1) Haga clic en menú **“Apple”** > **“Sistema de preferencias”**.
- 2) Haga clic en el icono de **“Red”**.
- 3) Haga clic en **“Ethernet”** en el cuadro de la izquierda y haga clic en **“Opciones Avanzadas”** en la esquina inferior derecha.
- 4) En las opciones superiores, seleccione **“TCP / IP”**.
- 5) En el menú desplegable junto a **“Configurar Ipv4”**, seleccione **“Usar Protocolo de configuración dinámica del host (DHCP)”**.
- 6) Haga clic en **“OK”** y luego en **“Aplicar”**.

- 3.2. Abra su navegador y escriba **192.168.1.1** en la barra de direcciones para visitar la página web de gestión del router.



3. 3. Seleccione el idioma de acuerdo a sus necesidades en el cuadro de la parte superior, Inglés es el idioma predeterminado.

- 1) En la página “**Configuración rápida**”, seleccione el tipo de conexión a Internet.
Si se selecciona “**DHCP(cable módem)**”, el router recibirá automáticamente los parámetros IP de su Proveedor de servicio de Internet (ISP).
Si se selecciona “**IP estática**”, por favor, introduzca la **Dirección IP de WAN / Máscara de subred / Puerta de enlace predeterminada / DNS** provistas por su proveedor de Servicio de Internet (ISP).
Si se selecciona “**PPPoE**”, introduzca el **Nombre de usuario** y **Contraseña** facilitado por su Proveedor de Servicio de Internet (ISP).
- 2) Según la **Configuración inalámbrica**, configure el nombre de la red inalámbrica el Identificador configurado de servicio (SSID) y la contraseña.
- 3) Haga clic izquierdo en “**Guardar**” para que los ajustes surtan efecto.

The screenshot shows the netis router's configuration interface. At the top, there is a language dropdown set to 'Español' and an 'Advanced' button with a gear icon. The main heading is 'Configuración rápida'. Under 'Tipo de conexión a Internet', there are four radio buttons: 'DHCP' (selected), 'IP estática IP', 'PPPoE', and 'Otro'. Below this is the 'Configuración inalámbrica' section, which includes two rows of settings for 2.4G and 5G SSIDs. Each row has a text input field for the SSID, an 'Avanzada' section with 'Desactivar' and 'Activar' radio buttons, and a 'Contraseña' text input field with a note '(Ingrese de 8 a 63 caracteres.)'. A 'Guardar' button is located at the bottom of the form.

Consejo 1:

Dirección IP predeterminada: 192.168.1.1

SSID 2.4G predeterminado: netis_2.4G_XXXXXX

SSID 5G predeterminado: netis_5G_XXXXXX

Contraseña inalámbrica predeterminada: password
(XXXXXX: Últimos 6 dígitos de la Dirección LAN MAC)

Consejo 2:

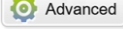
Puede hacer clic en el botón de  **Advanced** en la parte superior para otros tipos de conexión a Internet y otros ajustes.

4. Solución de Problemas

Q ¿Cómo puedo restablecer la configuración del router netis a su configuración predeterminada?

A Con el router encendido, utilice un bolígrafo para presionar y mantener el botón **Predeterminado (Default)** en el panel trasero unos 8 a 10 segundos antes de soltarlo. El router se reiniciará y todas las configuraciones vuelven a los valores predeterminados de fábrica.

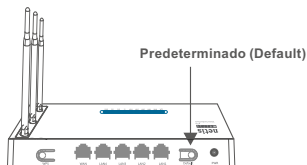

Q ¿Qué puedo hacer si mi Internet no es accesible?

- A**
- 1) Verificar si todas las conexiones de hardware son correctas. Por favor, consulte el paso **“Conexión del Hardware”**.
 - 2) Entrar a la página web de gestión de Router netis y asegúrese de establecer el tipo correcto de conexión a Internet. Para los usuarios de módem por cable, configure **“Clonar MAC”**, además.

En el menú de la izquierda, haga clic izquierdo en  **Advanced** > **“Red”**> **“WAN (Red de área amplia)”**. Y en la página central, haga clic en **“Avanzado”**> **“Clonar MAC”** y luego **“Guardar”**.

Dirección MAC : 08:10:76:3a:70:fb

Clonar MAC

Restaurar MAC

- 3) Reinicie el módem y luego el Router netis. Espere un minuto antes de comprobar de nuevamente Internet.
- 4) Si el acceso a Internet no está disponible, conecte el equipo directamente al módem e intente de nuevamente Internet. Si Internet continúa sin funcionar, póngase en contacto con su Proveedor de Servicios de Internet (ISP) para obtener ayuda.

Soporte Técnico: support@netis-systems.com



Router de Banda Dupla Wireless da netis
Guia de Instalação Rápida



1. Conteúdos da Embalagem

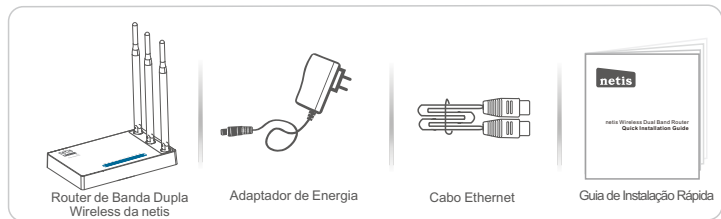

* Este Guia de Instalação Rápida é para todos os routers de banda dupla wireless da netis, incluindo os modelos - WF2471, WF2471D, WF2710, WF2710D, WF2722, WF2722D, WF2780, WF2780D, WF2891, WF2891D, etc.

* O modelo do produto mostrado como exemplo neste Guia é o WF2710.

2. Conexão de Hardware

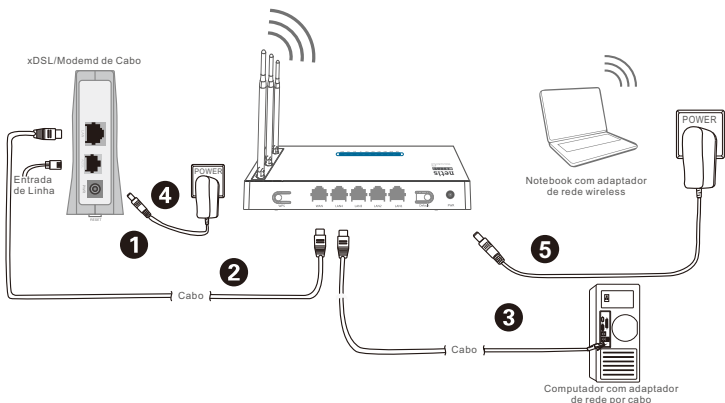

2.1. Desligue o seu Modem.

2.2. Ligue a porta **WAN** do Router da netis à porta **LAN** do Modem com um cabo Ethernet.

2.3. Ligue o seu computador a uma das portas **LAN** do Router da netis com um cabo Ethernet.

2.4. Ligue o seu Modem.

2.5. Ligue o Adaptador de Energia à entrada **PWR** do Router da netis e a outra ponta a uma tomada eléctrica padrão. Aguarde um minuto.

3. Configuração do Router através da Página de Gestão Web

3.1. Defina o endereço IP do adaptador de rede com cabo no seu computador para “Automático” ou “DHCP”.

Para Windows 8/ 7/Vista

- 1) Vá a “Definições” (Win 8)/ “Iniciar” (Win 7/Vista) > “Painel de Controlo”.
- 2) Clique em “Rede e Internet” > “Rede e Centro de Partilha” > “Alterar as definições do adaptador” (Win 8/7)/ “Gerir conexões de rede” (Win Vista).
- 3) Clique em “Conexão de Área Local” com o botão direito do rato e, de seguida, em “Propriedades”.
- 4) Faça duplo clique em “Protocolo de Internet Versão 4 (TCP/IPv4)”.
- 5) Seleccione “Obter um endereço IP automaticamente” e “Obter um endereço de servidor DNS automaticamente” e, de seguida, clique em “OK”.

Para Windows XP/2000

- 1) Vá a “Iniciar” > “Painel de Controlo”.
- 2) Clique em “Conexões de Rede e Internet” > “Conexões de Rede”.
- 3) Clique em “Conexão de Área Local” com o botão direito do rato e, de seguida, em “Propriedades”.
- 4) Faça duplo clique em “Protocolo de Internet (TCP/IP)”.
- 5) Seleccione “Obter um endereço IP automaticamente” e “Obter um endereço de servidor DNS automaticamente” e, de seguida, clique em “OK”.

Para SO MAC

- 1) Clique no menu “Apple” > “Preferências do Sistema”.
- 2) Clique no ícone “Rede”.
- 3) Clique em “Ethernet” na caixa de diálogo da esquerda e clique em “Avançadas” no canto inferior direito.
- 4) Nas opções superiores, seleccione “TCP/IP”.
- 5) No menu que desliza para baixo perto de “Configuração de IPv4”, seleccione “Utilizar DHCP”.
- 6) Clique em “OK” e de seguida em “Aplicar”.

3.2. Abra o seu navegador e digite **192.168.1.1** no campo de endereço para visitar a página de gestão web do router.



3.3. Selecciono o idioma que deseja na caixa superior. O padrão é Inglês.

1) Na página de “**Configuração rápida**”, selecciono o seu **Tipo de ligação à Internet**.

Se “**DHCP (cable modem)**” estiver seleccionado, o router irá receber automaticamente os parâmetros IP do seu ISP (Fornecedor de Serviço de Internet).

Se “**IP estático**” estiver seleccionado, digite o **Endereço IP da WAN/Máscara de sub-rede/Gateway predefinido/Servidores DNS** fornecidos pelo seu ISP.

Se “**PPPoE**” estiver seleccionado, digite o **Nome de utilizador** e a **Senha** fornecidos pelo seu ISP.

2) Na **Configuração sem fios**, configure o seu nome de rede wireless (SSID) e palavra passe.

3) Clique em “**Guardar**” para aplicar as suas definições.

The screenshot shows the Netis router's configuration interface. At the top left is the 'netis' logo. To its right is a language dropdown menu set to 'Português' and an 'Advanced' button with a gear icon. The main heading is 'Configuração rápida'. Below this, there are two sections: 'Tipo de ligação à Internet' and 'Configuração sem fios'. The 'Tipo de ligação à Internet' section has a cloud icon and four radio buttons: 'DHCP' (selected), 'IP estático', 'PPPoE', and 'Outro'. The 'Configuração sem fios' section has a wireless signal icon and two rows of settings. The first row is for '2.4G' with SSID 'netis_2.4G_30E6CE', an 'Avançada' section with 'Desativar' and 'Ativar' (selected) radio buttons, and a 'Senha' field with 'password' and a note '(Introduza entre 8 e 63 caracteres.)'. The second row is for '5G' with SSID 'netis_5G_30E6CE', an 'Avançada' section with 'Desativar' and 'Ativar' (selected) radio buttons, and a 'Senha' field with 'password' and a note '(Introduza entre 8 e 63 caracteres.)'. At the bottom center is a 'Guardar' button.

Dica 1:

Endereço IP padrão: 192.168.1.1

SSID 2.4G padrão: netis_2.4G_XXXXXX SSID 5G padrão: netis_5G_XXXXXX

Palavra passé wireless padrão: password

(XXXXXX: 6 últimos dígitos do LAN Endereço MAC)

Dica 2:

Pode clicar no botão  (Avançadas) no topo para outros tipo de conexão à Internet e mais definições.

4. Resolução de Problemas

Q Como restauro a minha configuração do Router da netis para as suas definições de fábrica?

A Com o router ligado, utilize um pin para pressionar e manter o botão **Default (Padrão)** no painel traseiro durante 8 a 10 segundos. O router irá reiniciar e todas as configurações irão voltar aos padrões de fábrica.

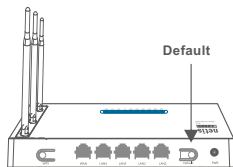

Q O que posso fazer se não conseguir aceder à Internet?

- A**
- 1) Verifique se as conexões de hardware estão correctas. Refira ao ponto "**Conexão de Hardware**".
 - 2) Faça o login na página de gestão web do Router e assegure-se que definiu o Tipo de Conexão de Internet correcto. Para os utilizadores de modem por cabo, configure também o "**Clone MAC**".

No menu do lado esquerdo, clique em  **Advanced** (**Avançadas**)> "**Rede**"> "**WAN**". Na página do meio, clique em "**Avançadas**"> "**Clone MAC**" e, de seguida, em "**Guardar**".

Endereço MAC : 08:10:76:3a:70:fb

Clone MAC

MAC predefinido

- 3) Reinicie o modem primeiro e depois o Router da netis. Aguarde um minuto antes de verificar a Internet novamente.
- 4) Se o acesso à Internet não estiver disponível, ligue o seu computador directamente ao modem e tente ligar à Internet novamente. Se a Internet não estiver a funcionar, contacte o seu ISP para mais informações.

Apoio Técnico: support@netis-systems.com



ROUTEUR DOUBLE BANDE
GUIDE D'INSTALLATION RAPIDE



1-Contenu de la boîte

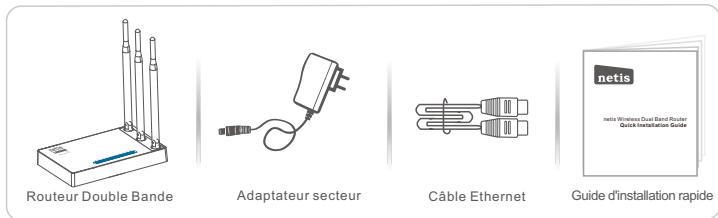

*Ce guide d' installation rapide concerne Routeur Double Bande: WF2471, WF2471D, WF2710, WF2710D, WF2722, WF2722D, WF2780, WF2780D, WF2891, WF2891D.

2-Connexion du matériel

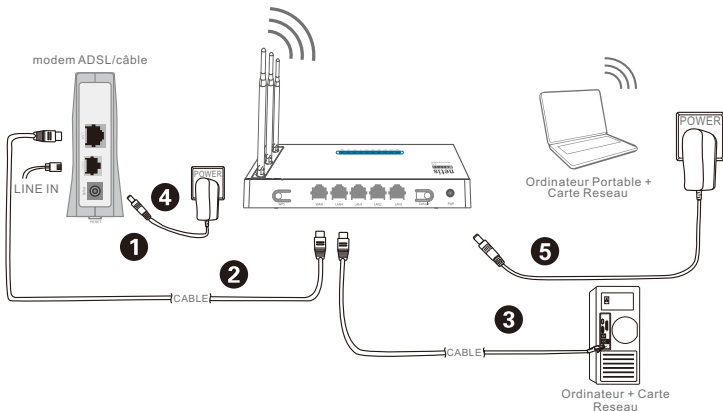

2-1-Eteignez votre modem.

2-2-Connectez le port **WAN** du routeur sur le port **LAN** du modem à l'aide d'un câble Ethernet.

2-3-Connectez votre ordinateur sur l'un des ports **LAN** du routeur à l'aide d'un câble Ethernet.

2-4-Allumez votre modem.

2-5-Branchez l'adaptateur secteur fourni sur le jack **PWR** qui se trouve sur le routeur et sur une prise murale puis attendez quelques minutes.

3-Configuration du routeur par page web

3-1-Paramétrez l'adresse IP de l'adaptateur réseau de votre ordinateur en tant que **Automatique** ou **DHCP**.

Sous Windows 8/7/Vista

- 1) Allez dans **Paramétrage** (Windows8)/ **Démarrer** (Windows7/Vista) puis dans le **Panneau de Configuration**.
- 2) Faites un clic droit souris sur **Réseau et Internet** > **Réseau et centre de Partage** > **Modifier les paramètres** (Windows8/7) / **Gérer les connexions réseau** (Windows Vista).
- 3) Faites un clic droit souris sur **Connexions au réseau local** et cliquez sur les **Propriétés**.
- 4) Faites un double clic sur **Protocoles Internet v4 (TCP/IPv4)**.
- 5) Sélectionnez **Obtenir une adresse IP automatiquement** et Obtenir le **DNS automatiquement** puis cliquez sur **OK**.

Sous Windows XP/2000

- 1) Allez dans **Démarrer** > **Panneau de Configuration**.
- 2) Faites un clic droit souris sur **Connexions Réseau et Internet** et **Connexions Réseau**.
- 3) Faites un clic droit souris sur **Connexions au Réseau local** et cliquez sur **Propriétés**.
- 4) Faites un double clic sur **Protocole Internet (TCP/IP)**.
- 5) Sélectionnez **Obtenir une adresse IP automatiquement** puis cliquez sur **OK**.

Sous MacOS

- 1) Cliquez sur le menu Apple et allez dans les **Préférences système**.
- 2) Cliquez sur l'icône **Réseau**.
- 3) Cliquez sur **Ethernet** et sur **Avancé**.
- 4) Sélectionnez **TCP/IP**.
- 5) Allez dans **Configure IPv4** > **DHCP**.
- 6) Cliquez sur **OK** puis sur **Appliquer**.

3-2-Ouvrez votre navigateur Internet et tapez l'adresse IP **192.168.1.1** dans la barre des adresses pour accéder à la page web du routeur.

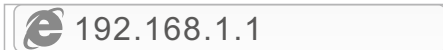

3-3- Sélectionnez la langue de l'interface, par défaut en anglais.

Sur la page **Configuration rapide**, sélectionnez le **Type de connexion Internet**.

>Si l'option **DHCP(Câble Modem)** est sélectionnée, le routeur reçoit automatiquement les paramètres IP de votre FAI.

>Si l'option **IP statique** est sélectionnée, entrez les paramètres IP donnés par votre FAI.

>Si l'option **PPPoE** est sélectionnée, entrez le nom et le mot de passe donnés par votre FAI.

Dans **Configuration sans fil** configurez le SSID du routeur.

Cliquez sur **Enregistrer** pour sauvegarder vos paramètres.

The screenshot shows the Netis router configuration page. At the top, there is a language dropdown set to 'Français' and an 'Advanced' button with a gear icon. The main heading is 'Configuration rapide'. Underneath, there is a section for 'Type de connexion Internet' with a cloud icon and four radio button options: DHCP (selected), IP statique, PPPoE, and Autre. Below this is the 'Configuration sans fil' section with a wireless icon. It contains two sections for 2.4G and 5G wireless settings. Each section has a text input for SSID (pre-filled with 'netis_2.4G_30E6CE' and 'netis_5G_30E6CE' respectively), a radio button for 'Avancés' (set to 'Activer'), and a text input for 'Mot de passe' (pre-filled with 'password'). A note below each password field says '(Veuillez entrer entre 8 et 63 caractères.)'. At the bottom of the configuration area is an 'Enregistrer' button.

Paramètres par défaut

Adresse IP	192.168.1.1
SSID 2.4G	netis_2.4G_XXXXXX
SSID 5G	netis_5G_XXXXXX
Mot de passe	password

(XXXXXX: 6 derniers chiffres de LAN Adresse MAC)

Vous pouvez cliquer sur le bouton  pour plus d'options.

4-Dépannage

Restaurer les paramètres par défaut

Allumez le routeur et appuyez pendant 8 à 10 secondes sur le bouton **DEFAULT** qui se trouve au dos du routeur. Le routeur redémarre avec les paramètres par défaut.

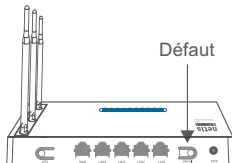

Impossible d'accéder à Internet

- 1) Vérifiez les connexions.
- 2) Faites un login vers la page de gestion web du routeur et vérifiez que vous avez paramétré le bon type de connexion Internet. Pour un modem câblé cliquez sur **Advanced(Avancé) > Réseau > WAN** et cliquez sur **Avancé** puis sur **Clone MAC** et **Save**.

Adresse MAC : 08:10:76:3a:70:fb

Clone MAC

MAC par défaut

- 3) Redémarrez le modem en premier puis le routeur. Attendez quelques minutes avant de vérifier à nouveau la connexion Internet.
- 4) Si vous n'avez toujours pas de connexion Internet, connectez l'ordinateur directement sur votre modem et essayez à nouveau. En cas de persistance du problème, contactez votre FAI.

Support technique : support@netis-systems.com

Appendix : FCC Statement

This equipment has been tested and found to comply with the limits for a Class B digital device, pursuant to part 15 of the FCC Rules. These limits are designed to provide reasonable protection against harmful interference in a residential installation. This equipment generates uses and can radiate radio frequency energy and, if not installed and used in accordance with the instructions, may cause harmful interference to radio communications. However, there is no guarantee that interference will not occur in a particular installation. If this equipment does cause harmful interference to radio or television reception, which can be determined by turning the equipment off and on, the user is encouraged to try to correct the interference by one or more of the following measures:

- Reorient or relocate the receiving antenna.
- Increase the separation between the equipment and receiver.
- Connect the equipment into an outlet on a circuit different from that to which the receiver is connected.
- Consult the dealer or an experienced radio/TV technician for help.

FCC Radiation Exposure Statement

This device complies with FCC radiation exposure limits set forth for an uncontrolled environment and it also complies with Part 15 of the FCC RF Rules. This transmitter must not be co-located or operating in conjunction with any other antenna or transmitter. This equipment should be installed and operated with a minimum distance of 20 centimeters between the radiator and your body.

This device complies with Part 15 of the FCC Rules. Operation is subject to the following two conditions:

- (1) this device may not cause harmful interference, and
- (2) this device must accept any interference received, including interference that may cause undesired operation.

Caution!

Any changes or modifications not expressly approved by the party responsible for compliance could void the user's authority to operate the equipment.

PKUM05249

NETIS SYSTEMS CO., LTD.
www.netis-systems.com
MADE IN CHINA

