



7368 Intelligent Services Access Manager ONT

7368 ISAM ONT G-240W-F Product Guide

3FE-47087-AAAA-TCZZA

Issue: 01

Nokia is a registered trademark of Nokia Corporation. Other products and company names mentioned herein may be trademarks or tradenames of their respective owners.

The information presented is subject to change without notice. No responsibility is assumed for inaccuracies contained herein.

© 2017 Nokia.

Contains proprietary/trade secret information which is the property of Nokia and must not be made available to, or copied or used by anyone outside Nokia without its written authorization. Not to be used or disclosed except in accordance with applicable agreements.

1 Preface

This preface provides general information about the documentation set for optical network terminals (ONTs).

1.1 Scope

This documentation set provides information about safety, features and functionality, ordering, hardware installation and maintenance, and software installation procedures for the current release.

1.2 Audience

This documentation set is intended for planners, administrators, operators, and maintenance personnel involved in installing, upgrading, or maintaining the ONTs.

1.3 Required knowledge

The reader must be familiar with general telecommunications principles.

1.4 Acronyms and initialisms

The expansions and optional descriptions of most acronyms and initialisms appear in the glossary.

1.5 Assistance and ordering phone numbers

Nokia provides global technical support through regional call centers. Phone numbers for the regional call centers are available at the following URL: <http://support.alcatel-lucent.com>.

For ordering information, contact your Nokia sales representative.

1.6 Nokia quality processes

Nokia's ONT quality practices are in compliance with TL 9000 requirements. These requirements are documented in the Fixed Networks Quality Manual 3FQ-30146-6000-QRZZA. The quality practices adequately ensure that technical requirements and customer end-point requirements are met. The customer or its representatives may be allowed to perform on-site quality surveillance audits, as agreed upon during contract negotiations

1.7 Safety information

For safety information, see the appropriate safety guidelines chapter.

1.8 Documents

Documents are available using ALED or OLCS.

Procedure 1 To download a ZIP file package of the customer documentation

-
- 1 Navigate to <http://support.alcatel-lucent.com> and enter your user name and password. If you are a new user and require access to this service, please contact your Nokia sales representative.

 - 2 From the Technical Content for drop-down menu, choose the product.

 - 3 Click on Downloads: Electronic Delivery.

 - 4 Choose Documentation from the drop-down menu and click Next.

 - 5 Select the image from the drop-down menu and click Next.

 - 6 Follow the on-screen directions to download the file.
-

Procedure 2 To access individual documents

Individual PDFs of customer documents are also accessible through the Nokia Customer Support website.

- 1 Navigate to <http://support.alcatel-lucent.com> and enter your user name and password. If you are a new user and require access to this service, please contact your Nokia sales representative.
 - 2 From the Technical Content for drop-down menu, choose the product.
 - 3 Click on Manuals and Guides to display a list of customer documents by title and part number. You can filter this list using the Release drop-down menu.
 - 4 Click on the PDF to open or save the file.
-

1.9 Special information

The following are examples of how special information is presented in this document.



Danger — Danger indicates that the described activity or situation may result in serious personal injury or death; for example, high voltage or electric shock hazards.



Warning — Warning indicates that the described activity or situation may, or will, cause equipment damage or serious performance problems.



Caution — Caution indicates that the described activity or situation may, or will, cause service interruption.



Note — A note provides information that is, or may be, of special interest.

1.9.1 Procedures with options or substeps

When there are options in a procedure, they are identified by letters. When there are required substeps in a procedure, they are identified by roman numerals.

Procedure 3 Example of options in a procedure

At step 1, you can choose option a or b. At step 2, you must do what the step indicates.

-
- 1 This step offers two options. You must choose one of the following:
 - a This is one option.
 - b This is another option.
-

- 2 You must perform this step.
-

Procedure 4 Example of required substeps in a procedure

At step 1, you must perform a series of substeps within a step. At step 2, you must do what the step indicates.

-
- 1 This step has a series of substeps that you must perform to complete the step. You must perform the following substeps:
 - i This is the first substep.
 - ii This is the second substep.
 - iii This is the third substep.
-

- 2 You must perform this step.
-

1.10 Multiple PDF document search

You can use Adobe Reader Release 6.0 and later to search multiple PDF files for a common term. Adobe Reader displays the results in a single display panel. The results are grouped by PDF file, and you can expand the entry for each file.



Note — The PDF files in which you search must be in the same folder.

Procedure 5 To search multiple PDF files for a common term

-
- 1 Open Adobe Acrobat Reader.

 - 2 Choose Edit→Search from the Acrobat Reader main menu. The Search PDF panel appears.

 - 3 Enter the search criteria.

 - 4 Click on the All PDF Documents In radio button.

 - 5 Select the folder in which to search using the drop-down menu.

 - 6 Click on the Search button.

Acrobat Reader displays the search results. You can expand the entries for each document by clicking on the + symbol.

Table of contents

1	Preface	3
1.1	Scope.....	3
1.2	Audience.....	3
1.3	Required knowledge.....	3
1.4	Acronyms and initialisms.....	3
1.5	Assistance and ordering phone numbers.....	3
1.6	Nokia quality processes.....	4
1.7	Safety information.....	4
1.8	Documents.....	4
1.9	Special information.....	5
1.9.1	Procedures with options or substeps.....	6
1.10	Multiple PDF document search.....	7
2	ETSI ONT safety guidelines	17
2.1	Safety instructions.....	17
2.1.1	Safety instruction boxes.....	17
2.1.2	Safety-related labels.....	18
2.2	Safety standards compliance.....	19
2.2.1	EMC, EMI, and ESD compliance.....	19
2.2.2	Equipment safety standard compliance.....	19
2.2.3	Environmental standard compliance.....	20
2.2.4	Laser product standard compliance.....	20
2.2.5	Resistibility requirements compliance.....	20
2.2.6	Acoustic noise emission standard compliance.....	20
2.3	Electrical safety guidelines.....	20
2.3.1	Power supplies.....	21
2.3.2	Cabling.....	21
2.3.3	Protective earth.....	21
2.4	ESD safety guidelines.....	21
2.5	Laser safety guidelines.....	21
2.5.1	Laser classification.....	22
2.5.1.1	Laser warning labels.....	22
2.5.2	Transmit optical output.....	24
2.5.3	Normal laser operation.....	24
2.5.4	Location class.....	25
2.6	Environmental requirements.....	25
3	ETSI environmental and CRoHS guidelines	27
3.1	Environmental labels.....	27
3.1.1	Overview.....	27
3.1.2	Environmental related labels.....	27
3.1.2.1	Products below Maximum Concentration Value (MCV) label.....	27
3.1.2.2	Products containing hazardous substances above Maximum Concentration Value (MCV) label.....	28
3.2	Hazardous Substances Table (HST).....	29

3.3 Other environmental requirements..... 30

7368 ISAM ONT G-240W-F Product Guide

3.3.1 ONT environmental requirements 30

3.3.2 Storage 30

3.3.3 Transportation 30

3.3.4 Stationary use 30

3.3.5 Thermal limitations..... 30

3.3.6 Material content compliance..... 31

3.3.7 End-of-life collection and treatment 31

4 ANSI ONT safety guidelines 33

4.1 Safety instructions 33

4.1.1 Safety instruction boxes in customer documentation 33

4.1.2 Safety-related labels 34

4.2 Safety standards compliance 35

4.2.1 EMC, EMI, and ESD standards compliance 36

4.2.2 Equipment safety standard compliance 36

4.2.3 Environmental standards compliance..... 37

4.2.4 Laser product standards compliance..... 37

4.2.5 Resistibility requirements compliance..... 38

4.3 Laser safety guidelines 38

4.3.1 Laser warning labels 38

4.3.2 Laser classification 40

4.3.3 Transmit optical output..... 41

4.3.4 Normal laser operation..... 41

4.3.5 Location class..... 41

4.4 Electrical safety guidelines..... 42

4.4.1 Power supplies 42

4.4.2 Cabling..... 42

4.4.3 Protective earth 42

4.5 ESD safety guidelines..... 42

4.6 Environmental requirements 43

5 G-240W-F unit data sheet 45

5.1 G-240W-F part numbers and identification 45

5.2 G-240W-F general description..... 47

5.2.1 TR-069 support 48

5.2.2 TR-104 parameter extension support for voice service..... 49

5.2.3 Mobile offload support 49

5.2.4 Bridged Residential Gateway (BRG) support..... 49

5.3 G-240W-F software and installation feature support..... 50

5.4 G-240W-F interfaces and interface capacity..... 50

5.4.1 G-240W-F connections and components 51

5.5 G-240W-F LEDs..... 53

5.6 G-240W-F detailed specifications 54

5.7 G-240W-F GEM ports and T-CONTs 55

5.8 G-240W-F performance monitoring statistics 55

5.9 G-240W-F functional blocks..... 57

5.10 G-240W-F standards compliance..... 60

5.10.1 Energy-related products standby and off modes compliance 61

5.11	G-240W-F special considerations	61
5.11.1	Wi-Fi service.....	61

7368 ISAM ONT G-240W-F Product Guide

5.11.1.1	Wi-Fi physical features.....	62
5.11.1.2	Wi-Fi standards and certifications	62
5.11.1.3	Wi-Fi GUI features.....	62
5.11.2	G-240W-F ONT considerations and limitations.....	62
6	Install a G-240W-F indoor ONT	65
6.1	Purpose.....	65
6.2	General	65
6.3	Prerequisites	65
6.4	Recommended tools.....	65
6.5	Safety information.....	66
6.6	Procedure.....	67
7	Replace a G-240W-F indoor ONT	73
7.1	Purpose.....	73
7.2	General	73
7.3	Prerequisites	73
7.4	Recommended tools.....	73
7.5	Safety information.....	74
7.6	Procedure.....	75
8	Configure a G-240W-F indoor ONT.....	81
8.1	General	81
8.2	HGU mode GUI configuration	81
8.2.1	Login.....	81
8.2.2	Device and connection status.....	82
8.2.3	Network configuration	93
8.2.4	Security configuration	109
8.2.5	Application configuration.....	119
8.2.6	Maintenance.....	128
8.2.7	RG troubleshooting counters.....	140
8.3	SFU mode GUI configuration	142
8.3.1	Login.....	142
8.3.2	Device and connection status.....	143
8.3.3	Network configuration	146
8.3.4	Maintenance.....	147
8.4	Operator ID	151
9	ONT configuration file over OMCI	153
9.1	Purpose.....	153
9.2	Supported configuration file types	153
9.2.1	Filename conventions	155
9.3	ONT configuration file over OMCI.....	155

List of figures

2	ETSI ONT safety guidelines	17
Figure 1	PSE certification	19
Figure 2	Laser product label	22
Figure 3	Laser classification label.....	23
Figure 4	Laser warning labels	24
3	ETSI environmental and CRoHS guidelines	27
Figure 5	Products below MCV value label.....	28
Figure 6	Products above MCV value label.....	29
Figure 7	Recycling/take back/disposal of product symbol.....	31
4	ANSI ONT safety guidelines	33
Figure 8	Sample safety label on the ONT equipment	35
Figure 9	Sample laser product label showing CDRH 21 CFR compliance	37
Figure 10	Laser product label	39
Figure 11	Laser classification label	39
Figure 12	Laser warning labels	40
Figure 13	Sample laser product safety label on the ONT equipment	41
5	G-240W-F unit data sheet	45
Figure 14	G-240W-F indoor ONT physical connections (back view)	51
Figure 15	G-240W-F ONT Reset, LED, WLAN, and WPS buttons and fiber optic connection (bottom and side view).....	52
Figure 16	G-240W-F indoor ONT LEDs	53
Figure 17	Single-residence Wi-Fi ONT with Gigabit Ethernet and POTS and without RF video.....	58
Figure 18	G-240W-F ONT hardware block	59
Figure 19	G-240W-F ONT product label	60
Figure 20	G-240W-F ONT safety label.....	61
6	Install a G-240W-F indoor ONT	65
Figure 21	G-240W-F indoor ONT wall mounting holes (bottom view)	67
Figure 22	G-240W-F indoor ONT connections (back view)	68
Figure 23	G-240W-F ONT Reset, LED, WLAN, and WPS buttons and fiber optic connection (bottom and side view).....	69
Figure 24	G-240W-F indoor ONT with fiber cover open	69
7	Replace a G-240W-F indoor ONT	73
Figure 25	G-240W-F indoor ONT Reset, LED, WLAN, and WPS buttons (side)	75
Figure 26	G-240W-F indoor ONT connections (back view)	76
Figure 27	G-240W-F indoor ONT fiber optic port (bottom view).....	77
8	Configure a G-240W-F indoor ONT	81
Figure 28	Web login window.....	82
Figure 29	Device Information window	83
Figure 30	LAN status window	84
Figure 31	WAN status window.....	86

Figure 32	WAN status IPv6 window.....	87
Figure 33	Home networking information window.....	89
Figure 34	Optics module status window.....	90
Figure 35	LAN ports Statistics window.....	91
Figure 36	Voice Information window.....	92
Figure 37	LAN network window.....	94
Figure 38	LAN IPv6 network window.....	96
Figure 39	WAN network window.....	98
Figure 40	WAN DHCP window.....	99
Figure 41	Wireless 2.4GHz network window.....	100
Figure 42	Wireless Schedule window.....	103
Figure 43	IP Routing network window.....	104
Figure 44	DNS network window.....	105
Figure 45	TR-069 network window.....	107
Figure 46	QoS Config window (L2).....	108
Figure 47	Firewall window.....	110
Figure 48	MAC filter window.....	111
Figure 49	IP filter window.....	112
Figure 50	URL Filter window.....	114
Figure 51	Parental Control window.....	115
Figure 52	DMZ and ALG window.....	116
Figure 53	Access Control window.....	118
Figure 54	Port forwarding window.....	120
Figure 55	Port Triggering window.....	121
Figure 56	DDNS window.....	122
Figure 57	NTP window.....	123
Figure 58	USB window.....	124
Figure 59	UPnP and DLNA window.....	126
Figure 60	Voice setting window.....	127
Figure 61	Password window.....	129
Figure 62	Speed Test window.....	130
Figure 63	LOID Config window.....	131
Figure 64	SLID configuration window.....	132
Figure 65	Device management window.....	133
Figure 66	Backup and Restore window.....	134
Figure 67	Firmware upgrade window.....	135
Figure 68	Reboot window.....	136
Figure 69	Factory default window.....	137
Figure 70	Diagnostics window.....	138
Figure 71	Log window.....	139
Figure 72	RG Troubleshooting Counters window.....	141
Figure 73	Web login window.....	143
Figure 74	Device Information window.....	144
Figure 75	Optics module status window.....	145
Figure 76	Wireless Schedule window.....	146
Figure 77	Password window.....	148
Figure 78	LOID Authentication window.....	149
Figure 79	SLID configuration window.....	150

List of tables

2	ETSI ONT safety guidelines	17
Table 1	Safety labels.....	18
4	ANSI ONT safety guidelines.....	33
Table 2	Safety labels.....	34
5	G-240W-F unit data sheet.....	45
Table 3	Identification of G-240W-F indoor ONTs.....	45
Table 4	G-240W-F indoor ONT interface connection capacity	51
Table 5	G-240W-F indoor ONT physical connections.....	52
Table 6	G-240W-F indoor ONT LEDs.....	53
Table 7	G-240W-F indoor ONT physical specifications.....	54
Table 8	G-240W-F indoor ONT power consumption specifications	55
Table 9	G-240W-F indoor ONT environmental specifications.....	55
Table 10	G-240W-F indoor ONT capacity for GEM ports and T-CONTs	55
Table 11	Package S ONTs ONTENET performance monitoring statistics	56
Table 12	Package S ONTs ONTL2UNI performance monitoring statistics.....	56
Table 13	Package S ONTs PONONTTC, PONONTMCTC, PONONTTCHSI, PONONTTCES, PONONTTCFLOW, PONONTTCVOIP performance monitoring statistics	57
Table 14	Package S ONTs PONONTTC aggregate performance monitoring statistics.....	57
Table 15	G-240W-F ONT considerations and limitations	62
8	Configure a G-240W-F indoor ONT	81
Table 16	Device Information parameters.....	83
Table 17	LAN status parameters.....	85
Table 18	WAN status parameters	86
Table 19	WAN status IPv6 parameters	88
Table 20	Home networking parameters	89
Table 21	Optics module status parameters.....	90
Table 22	Voice Information parameters	92
Table 23	LAN network parameters.....	94
Table 24	LAN IPv6 network parameters.....	96
Table 25	WAN network parameters	98
Table 26	WAN DHCP parameters.....	100
Table 27	WiFi 2.4G network parameters.....	101
Table 28	IP Routing network parameters	104
Table 29	DNS network parameters	106
Table 30	TR-069 network parameters.....	107
Table 31	QoS Config parameters.....	108
Table 32	Firewall parameters.....	111
Table 33	MAC filter parameters	112
Table 34	IP filter parameters.....	113
Table 35	URL Filter parameters.....	114
Table 36	Parental control parameters	115
Table 37	DMZ and ALG parameters	117

Table 38	Access control parameters.....	118
Table 39	Port forwarding parameters.....	120
Table 40	Port triggering parameters	121
Table 41	DDNS parameters	123
Table 42	USB parameters	124
Table 43	Voice setting parameters	127
Table 44	Password parameters	130
Table 45	LOID configuration parameters	131
Table 46	SLID configuration parameters	132
Table 47	Device management parameters	134
Table 48	RG Troubleshooting Counters parameters	141
Table 49	Device Information parameters	144
Table 50	Optics module status parameters.....	145
Table 51	Password parameters	148
Table 52	LOID configuration parameters	149
Table 53	SLID configuration parameters	150
9	ONT configuration file over OMCI	153
Table 54	Supported configuration files.....	154

2 ETSI ONT safety guidelines

This chapter provides information about the mandatory regulations that govern the installation and operation of the optical network terminals (ONTs).

2.1 Safety instructions

This section describes the safety instructions that are provided in the ONT customer documentation and on the equipment.

2.1.1 Safety instruction boxes

The safety instruction boxes are provided in the ONT customer documentation. Observe the instructions to meet safety requirements.

The following is an example of the Danger box.



Danger — Possibility of personal injury.

The Danger box indicates that the described activity or situation may pose a threat to personal safety. It calls attention to a situation or procedure which, if not correctly performed or adhered to, may result in death or serious physical harm.

Do not proceed beyond a Danger box until the indicated conditions are fully understood and met.

The following is an example of the Warning box.



Warning 1 — Possibility of equipment damage.

Warning 2 — Possibility of data loss.

The Warning box indicates that the described activity or situation may, or will, cause equipment damage, loss of data, or serious performance problems. It identifies a possible equipment-damaging situation or provides essential information to avoid the degradation of system operations or data.

Do not proceed beyond a warning until the indicated conditions are fully understood and met.

The following is an example of the Caution box.



Caution 1 — Possibility of service interruption.

Caution 2 — Service interruption.

The Caution box indicates that the described activity or situation may, or will, cause service interruption.

Do not proceed beyond a caution until the indicated conditions are fully understood and met.

The following is an example of the Note box.



Note — Information of special interest.

The Note box provides information that assists the personnel working with ONTs. It does not provide safety-related instructions.

2.1.2 Safety-related labels

The ONT equipment is labeled with the specific safety instructions and compliance information that is related to a variant of the ONT. Observe the instructions on the safety labels.

Table 1 provides sample safety labels on the ONT equipment.

Table 1 Safety labels

Description	Label text
ESD warning	Caution: This assembly contains an electrostatic sensitive device.
Laser classification	Class 1 laser product
PSE marking	These power supplies are Japan PSE certified and compliant with Japan VCCI emissions standards.

Figure 1 shows the PSE certification.

Figure 1 PSE certification

 Warning	This is a Class B product based on the standard of the Voluntary Control Council for Interference from Information Technology Equipment (VCCI). If this is used near a radio or television receiver in a domestic environment, it may cause radio interference. Install and use the equipment according to the instruction manual.
警告	VCCI準拠クラスB機器（日本） この機器は、Information Technology EquipmentのVoluntary Control Council for Interference (VCCI)の規格に準拠したクラスB製品です。この機器をラジオやテレビ受信機の近くで使用した場合、混信が発生する恐れがあります。本機器の設置および使用に際しては、取扱説明書に従ってください。

19841

2.2 Safety standards compliance

This section describes the ONT compliance with the European safety standards.

2.2.1 EMC, EMI, and ESD compliance

The ONT equipment complies with the following EMC, EMI, and ESD requirements:

- EN 300-328 v1.9.1 wide band data transmission standards for 2.4GHz bands
- EN 300-386 V1.5.1: Electromagnetic Compatibility and Radio Spectrum Matters (ERM): Telecommunications Network Equipment; Electromagnetic Compatibility (EMC) requirements; Electrostatic Discharge (ESD) requirements
- EN 55022 (2006): Class B, Information Technology Equipment, Radio Disturbance Characteristics, limits and methods of measurement
- EN 55024 (2010): Information Technology Equipment, Immunity Characteristics, limits and methods of measurement
- European Council Directive 2004/108/EC
- EN 300-386 V1.4.1: 2008
- EN 55022:2006 Class B (ONTs)

2.2.2 Equipment safety standard compliance

The ONT equipment complies with the requirements of EN 60950-1, Safety of Information Technology Equipment for use in a restricted location (per R-269).

2.2.3 Environmental standard compliance

The ONT equipment complies with the EN 300 019 European environmental standards.

2.2.4 Laser product standard compliance

For most ONTs, the ONT equipment complies with EN 60825-1 and IEC 60825-2 for laser products. If there is an exception to this compliance regulation, you can find this information in the standards compliance section of the unit data sheet in this Product Guide.

2.2.5 Resistibility requirements compliance

The ONT equipment complies with the requirements of ITU Recommendation K.21 for resistibility of telecommunication equipment installed in customer premises to over voltage and overcurrents.

2.2.6 Acoustic noise emission standard compliance

The ONT equipment complies with EN 300 753 acoustic noise emission limit and test methods.

2.3 Electrical safety guidelines

This section provides the electrical safety guidelines for the ONT equipment.



Note 1 — The ONTs comply with the U.S. National Electrical Code. However, local electrical authorities have jurisdiction when there are differences between the local and U.S. standards.

Note 2 — The ONTs comply with BS EN 61140.

2.3.1 Power supplies

The use of any non-Nokia approved power supplies or power adapters is not supported or endorsed by Nokia. Such use will void any warranty or support contract with Nokia. Such use greatly increases the danger of damage to equipment or property.

2.3.2 Cabling

The following are the guidelines regarding cables used for the ONT equipment:

- All cables must be approved by the relevant national electrical code.
- The cables for outdoor installation of ONTs must be suitable for outdoor use.
- POTS wiring run outside the subscriber premises must comply with the requirements of local electrical codes. In some markets, the maximum allowed length of the outside run is 140 feet (43 m). If the outside run is longer, NEC requires primary protection at both the exit and entry points for the wire.

2.3.3 Protective earth

Earthing and bonding of the ONTs must comply with the requirements of local electrical codes.

2.4 ESD safety guidelines

The ONT equipment is sensitive to ESD. Operations personnel must observe the following ESD instructions when they handle the ONT equipment.



Caution — This equipment is ESD sensitive. Proper ESD protections should be used when you enter the TELCO Access portion of the ONT.

During installation and maintenance, service personnel must wear wrist straps to prevent damage caused by ESD.

2.5 Laser safety guidelines

Observe the following instructions when you perform installation, operations, and maintenance tasks on the ONT equipment.

Only qualified service personnel who are extremely familiar with laser radiation hazards should install or remove the fiber optic cables and units in this system.



Danger — There may be invisible laser radiation at the fiber optic cable when the cable is removed from the connector. Avoid direct exposure to the laser beam.

Observe the following danger for laser hazard. Eyes can be damaged when they are exposed to a laser beam. Take necessary precautions before you plug in the optical modules.



Danger — Possibility of equipment damage. Risk of eye damage by laser radiation.

2.5.1 Laser classification

The ONT is classified as a Class 1 laser product based on its transmit optical output.

2.5.1.1 Laser warning labels

The following figures show the labels related to laser product, classification and warning.

Figure 2 shows a laser product label.

Figure 2 Laser product label

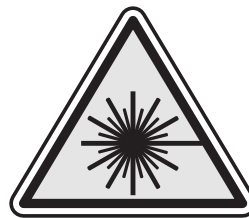

18455

Figure 3 shows a laser classification label. Laser classification labels may be provided in other languages.

Figure 3 Laser classification label

Figure 4 shows a laser warning label and an explanatory label for laser products. Labels and warning may be provided in other languages. The explanatory label provides the following information:

- a warning that calls attention to the invisible laser radiation
- an instruction against staring into the beam or viewing directly with optical instruments
- wavelength
- normal output power
- maximum output power

Figure 4 Laser warning labels

18993

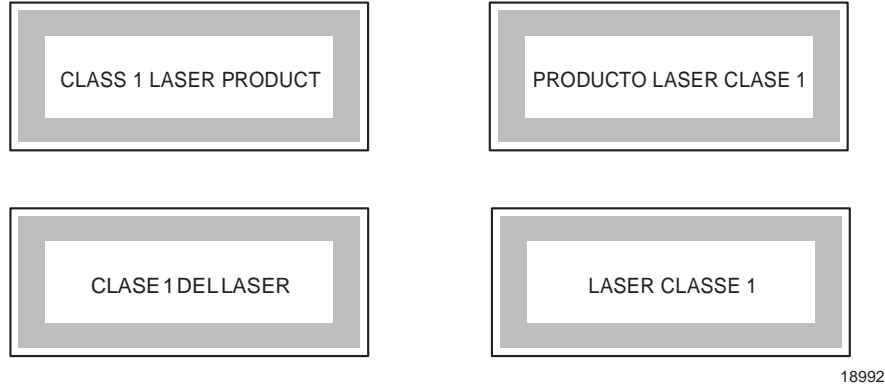
2.5.2 Transmit optical output

The maximum transmit optical output of an ONT is +5 dBm.

2.5.3 Normal laser operation

In normal operation, fiber cable laser radiation is always off until it receives signal from the line terminal card.

Eyes can be damaged when they exposed to a laser beam. Operating personnel must observe the instructions on the laser explanatory label before plugging in the optical module.



Danger — Risk of eye damage by laser radiation.

2.5.4 Location class

Use cable supports and guides to protect the receptacles from strain.

2.6 Environmental requirements

See the ONT technical specification documentation for more information about temperature ranges.

During operation in the supported temperature range, condensation inside the ONT caused by humidity is not an issue. To avoid condensation caused by rapid changes in temperature and humidity, Nokia recommends:

- The door of the ONT not be opened until temperature inside and outside the enclosure has stabilized.
- If the door of the ONT must be opened after a rapid change in temperature or humidity, use a dry cloth to wipe down the metal interior to prevent the risk of condensation.
- When high humidity is present, installation of a cover or tent over the ONT helps prevent condensation when the door is opened.

3 ETSI environmental and CRoHS guidelines

This chapter provides information about the ETSI environmental China Restriction of Hazardous Substances (CRoHS) regulations that govern the installation and operation of the optical line termination (OLT) and optical network termination (ONT) systems. This chapter also includes environmental operation parameters of general interest.

3.1 Environmental labels

This section describes the environmental instructions that are provided with the customer documentation, equipment, and location where the equipment resides.

3.1.1 Overview

CRoHS is applicable to Electronic Information Products (EIP) manufactured or sold and imported in the territory of the mainland of the People's Republic of China. EIP refers to products and their accessories manufactured by using electronic information technology, including electronic communications products and such subcomponents as batteries and cables.

3.1.2 Environmental related labels

Environmental labels are located on appropriate equipment. The following are sample labels.

3.1.2.1 Products below Maximum Concentration Value (MCV) label

Figure 5 shows the label that indicates a product is below the maximum concentration value, as defined by standard SJ/T11363-2006 (Requirements for Concentration Limits for Certain Hazardous Substances in Electronic Information Products). Products with this label are recyclable. The label may be found in this documentation or on the product.

Figure 5 Products below MCV value label



18986

3.1.2.2 Products containing hazardous substances above Maximum Concentration Value (MCV) label

Figure 6 shows the label that indicates a product is above the maximum concentration value, as defined by standard SJ/T11363-2006 (Requirements for Concentration Limits for Certain Hazardous Substances in Electronic Information Products). The number contained inside the label indicates the Environment-Friendly User Period (EFUP) value. The label may be found in this documentation or on the product.

Figure 6 Products above MCV value label

18985

Together with major international telecommunications equipment companies, Nokia has determined it is appropriate to use an EFUP of 50 years for network infrastructure equipment and an EFUP of 20 years for handsets and accessories. These values are based on manufacturers' extensive practical experience of the design, manufacturing, maintenance, usage conditions, operating environments, and physical condition of infrastructure and handsets after years of service. The values reflect minimum values and refer to products operated according to the intended use conditions. See "[Hazardous Substances Table \(HST\)](#)" for more information.

3.2 Hazardous Substances Table (HST)

This section describes the compliance of the OLT and ONT equipment to the CRoHS standard when the product and subassemblies contain hazardous substances beyond the MCV value. This information is found in this user documentation where part numbers for the product and subassemblies are listed. It may be referenced in other OLT and ONT documentation.

In accordance with the People's Republic of China Electronic Industry Standard Marking for the Control of Pollution Caused by Electronic Information Products (SJ/T11364-2006), customers may access the Nokia Hazardous Substance Table, in Chinese, from the following location:

- <http://www.alcatel-sbell.com.cn/wwwroot/images/upload/private/1/media/ChinaRoHS.pdf>

3.3 Other environmental requirements

Observe the following environmental requirements when handling the P-OLT or ONT equipment.

3.3.1 ONT environmental requirements

See the ONT technical specification documentation for more information about temperature ranges.

3.3.2 Storage

According to ETS 300-019-1-1 - Class 1.1, storage of OLT equipment must be in Class 1.1, weather-protected, temperature-controlled locations.

3.3.3 Transportation

According to EN 300-019-1-2 - Class 2.3, transportation of the OLT equipment must be in packed, public transportation with no rain on packing allowed.

3.3.4 Stationary use

According to EN 300-019-1-3 - Class 3.1/3.2/3.E, stationary use of OLT equipment must be in a temperature-controlled location, with no rain allowed, and with no condensation allowed.

3.3.5 Thermal limitations

When the OLT is installed in the CO or CEV, install air filters on the P-OLT. The thermal limitations for OLT operation in a CO or CEV are:

- operating temperature: 5°C to 40°C (41°F to 104°F)
- short-term temperature: -5°C to 50°C (23°F to 122°F)
- operating relative humidity: 5% to 85%
- short-term relative humidity: 5% to 95%, but not to exceed 0.024 kg of water/kg

3.3.6 Material content compliance

European Union (EU) Directive 2002/95/EC, “Restriction of the use of certain Hazardous Substances” (RoHS), restricts the use of lead, mercury, cadmium, hexavalent chromium, and certain flame retardants in electrical and electronic equipment. This Directive applies to electrical and electronic products placed on the EU market after 1 July 2006, with various exemptions, including an exemption for lead solder in network infrastructure equipment. Nokia products shipped to the EU after 1 July 2006 comply with the EU RoHS Directive.

Nokia has implemented a material/substance content management process. The process is described in: Nokia process for ensuring RoHS Compliance (1AA002660031ASZZA). This ensures compliance with the European Union Directive 2011/65/EU on the Restriction of the Use of Certain Hazardous Substances in Electrical and Electronic Equipment (RoHS2). With the process equipment is assessed in accordance with the Harmonised Standard EN50581:2012 (CENELEC) on Technical documentation for the assessment of electrical and electronic products with respect to the restriction of hazardous substances.

3.3.7 End-of-life collection and treatment

Electronic products bearing or referencing the symbol shown in Figure 7, when put on the market within the European Union (EU), shall be collected and treated at the end of their useful life, in compliance with applicable EU and local legislation. They shall not be disposed of as part of unsorted municipal waste. Due to materials that may be contained in the product, such as heavy metals or batteries, the environment and human health may be negatively impacted as a result of inappropriate disposal.



Note — In the European Union, a solid bar under the symbol for a crossed-out wheeled bin indicates that the product was put on the market after 13 August 2005.

Figure 7 Recycling/take back/disposal of product symbol



At the end of their life, the OLT and ONT products are subject to the applicable local legislations that implement the European Directive 2012/19EU on waste electrical and electronic equipment (WEEE).

There can be different requirements for collection and treatment in different member states of the European Union.

In compliance with legal requirements and contractual agreements, where applicable, Nokia will offer to provide for the collection and treatment of Nokia products bearing the logo shown in Figure 7 at the end of their useful life, or products displaced by Nokia equipment offers. For information regarding take-back of equipment by Nokia, or for more information regarding the requirements for recycling/disposal of product, contact your Nokia account manager or Nokia take back support at sustainability.global@nokia.com.

4 ANSI ONT safety guidelines

This chapter provides information about the mandatory regulations that govern the installation and operation of the optical network terminals or units (ONTs or ONUs) in the North American or ANSI market.

4.1 Safety instructions

This section describes the safety instructions that are provided in the ONT customer documentation and on the equipment.

4.1.1 Safety instruction boxes in customer documentation

The safety instruction boxes are provided in the ONT customer documentation. Observe the instructions to meet safety requirements.

The following is an example of the Danger box.



Danger — Possibility of personal injury.

The Danger box indicates that the described activity or situation may pose a threat to personal safety. It calls attention to a situation or procedure which, if not correctly performed or adhered to, may result in death or serious physical harm.

Do not proceed beyond a Danger box until the indicated conditions are fully understood and met.

The following is an example of the Warning box.



Warning 1 — Possibility of equipment damage.

Warning 2 — Possibility of data loss.

The Warning box indicates that the described activity or situation may, or will, cause equipment damage, loss of data, or serious performance problems. It identifies a possible equipment-damaging situation or provides essential information to avoid the degradation of system operations or data.

Do not proceed beyond a warning until the indicated conditions are fully understood and met.

The following is an example of the Caution box.



Caution 1 — Possibility of service interruption.

Caution 2 — Service interruption.

The Caution box indicates that the described activity or situation may, or will, cause service interruption.

Do not proceed beyond a caution until the indicated conditions are fully understood and met.

The following is an example of the Note box.



Note — Information of special interest.

The Note box provides information that assists the personnel working with ONTs. It does not provide safety-related instructions.

4.1.2 Safety-related labels

The ONT equipment is labeled with specific safety compliance information and instructions that are related to a variant of the ONT. Observe the instructions on the safety labels.

Table 2 provides examples of the text in the various ONT safety labels.

Table 2 Safety labels

Description	Label text
UL compliance	Communication service equipment US listed. Type 3R enclosure - Rainproof.
TUV compliance	Type 3R enclosure - Rainproof.
ESD warning	Caution: This assembly contains electrostatic sensitive device.
Laser classification	Class 1 laser product
Laser product compliance	This laser product conforms to all applicable standards of 21 CFR 1040.10 at date of manufacture.
FCC standards compliance	Tested to comply with FCC standards for home or office use.
CDRH compliance	Complies with 21 CFR 1040.10 and 1040.11 except for deviations pursuant to Laser Notice No. 50, dated June 24, 2007

(1 of 2)

Description	Label text
Operation conditions	This device complies with Part 15 of the FCC Rules. Operation is subject to the following two conditions: (1) this device may not cause harmful interference, and (2) this device must accept any interference received, including interference that may cause undesired operation.
Canadian standard compliance (modular ONT)	This Class A digital apparatus complies with Canadian ICES-003.
Canadian standard compliance (outdoor ONT)	This Class B digital apparatus complies with Canadian ICES-003.
CE marking	There are various CE symbols for CE compliance.

(2 of 2)

Figure 8 shows a sample safety label on the ONT equipment.

Figure 8 Sample safety label on the ONT equipment

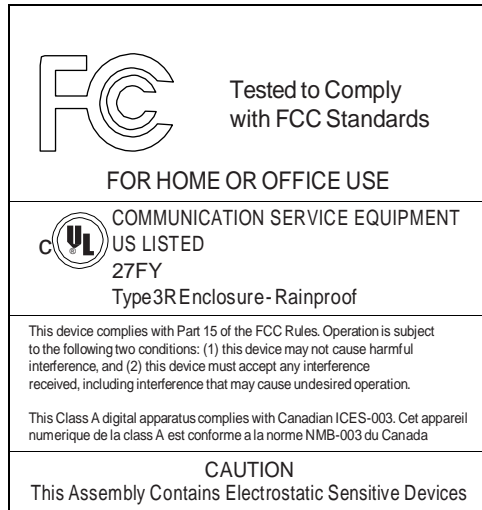

18533

4.2 Safety standards compliance

This section describes the ONT compliance with North American safety standards.



Warning — Changes or modifications to this unit not expressly approved by the party responsible for compliance could void the user's authority to operate the equipment.

4.2.1 EMC, EMI, and ESD standards compliance

The ONT equipment complies with the following requirements:

- Federal Communications Commission (FCC) CFR 47, Part 15, Subpart B, Class A requirements for OLT equipment
- GR-1089-CORE requirements, including:
 - Section 3 Electromagnetic Interference, Emissions Radiated and Conducted
 - Section 3 Immunity, Radiated and Conducted
 - Section 2 ESD Discharge Immunity: System Level Electrostatic Discharge and EFT Immunity: Electrically Fast Transients

This equipment has been tested and found to comply with the limits for a Class B digital device, pursuant to Part 15 of the FCC Rules. These limits are designed to provide reasonable protection against harmful interference in a residential installation. This equipment generates, uses and can radiate radio frequency energy and, if not installed and used in accordance with the instructions, may cause harmful interference to radio communications.

However, there is no guarantee that interference will not occur in a particular installation. If this equipment does cause harmful interference to radio or television reception, which can be determined by turning the equipment off and on, the user is encouraged to try to correct the interference by one or more of the following measures:

- Reorient or relocate the receiving antenna.
- Increase the separation between the equipment and receiver.
- Connect the equipment into an outlet on a circuit different from that to which the receiver is needed.
- Consult the dealer or an experienced radio/TV technician for help.

4.2.2 Equipment safety standard compliance

The ONT equipment complies with the requirements of UL60950-1, Outdoor ONTs to “Communication Service Equipment” (CSE) and Indoor ONTs to Information Technology Equipment (ITE).

4.2.3 Environmental standards compliance

The ONT equipment complies with the following standards:

- GR-63-CORE (NEBS): requirements related to operating, storage, humidity, altitude, earthquake, office vibration, transportation and handling, fire resistance and spread, airborne contaminants, illumination, and acoustic noise
- GR-487-CORE: requirements related to rain, chemical, sand, and dust
- GR-487 R3-82: requirements related to condensation
- GR-3108: Requirements for Network Equipment in the Outside Plant (OSP)
- TP76200: Common Systems Equipment Interconnections Standards

4.2.4 Laser product standards compliance

The ONT equipment complies with 21 CFR 1040.10 and CFR 1040.11, except for deviations pursuant to Laser Notice No. 50, dated June 24, 2007” or to 21 CFR 1040.10 U.S. Center for Devices and Radiological Health (CDRH) of the Food and Drug Administration (FDA) Laser Notice 42 for ONTs containing Class 1 Laser modules certified by original manufactures.

Per CDRH 21 CFR 10.40.10 (h) (1) (iv) distributors of Class 1 laser products, such as Nokia ONTs shall leave the following Laser Safety cautions with the end user.

- “Class 1 Laser Product”
- “Caution – Use of controls or adjustments or performance of procedures other than those specified herein may result in hazardous radiation exposure.”

Figure 9 shows a laser product label.

Figure 9 Sample laser product label showing CDRH 21 CFR compliance

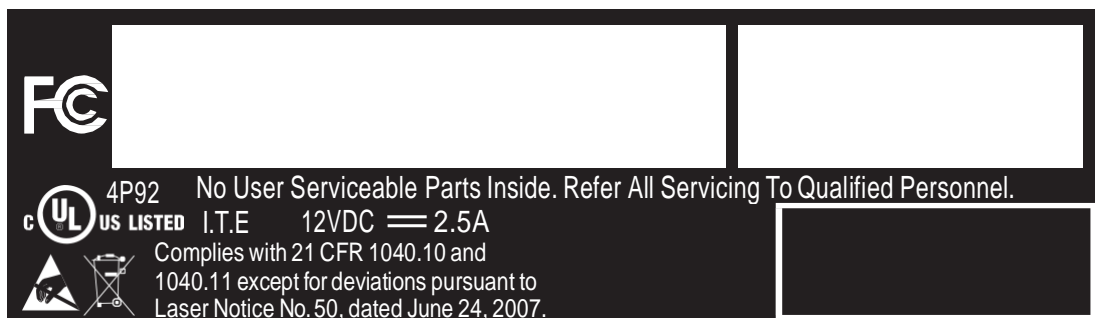

22813

4.2.5 Resistibility requirements compliance

The ONT equipment complies with the requirements of ITU Recommendation K.21 for resistibility of telecommunication equipment installed in customer premises to overvoltage and overcurrents.

4.3 Laser safety guidelines

Only qualified service personnel who are extremely familiar with laser radiation hazards should install or remove the fiber optic cables and units in this system.

Observe the following warnings when you perform installation, operations, and maintenance tasks on the ONT equipment.



Danger — There may be invisible laser radiation at the fiber optic cable when the cable is removed from the connector. Avoid direct exposure to beam.

Observe the following danger for a laser hazard. Eyes can be damaged when they are exposed to a laser beam. Take necessary precautions before you plug in the optical modules.



Danger — Possibility of equipment damage. Risk of eye damage by laser radiation.

Per CDRH 21 CFR 10.40.10 (h) (1) (iv) distributors of Class 1 laser products, such as Nokia ONTs shall leave the following Laser Safety cautions with the end user.

- a) "Class 1 Laser Product"
- b) "Caution – Use of controls or adjustments or performance of procedures other than those specified herein may result in hazardous radiation exposure."

4.3.1 Laser warning labels

The following figures show sample labels related to laser product, classification and warning.

Figure 10 shows a laser product label.

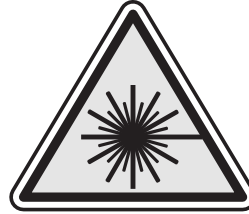
Figure 10 Laser product label

18455

Figure 11 shows a laser classification label. Laser classification labels may be provided in other languages.

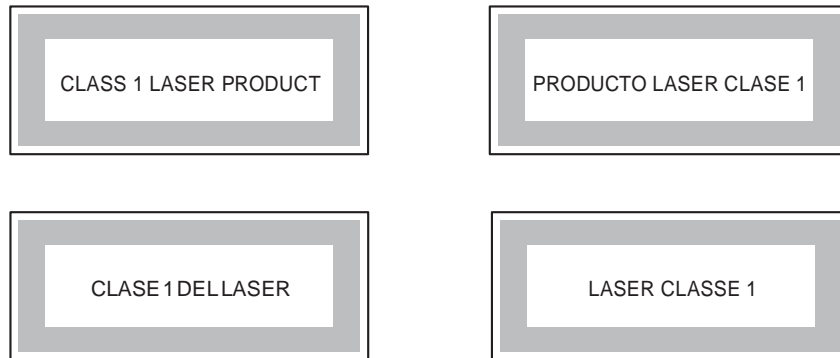
Figure 11 Laser classification label

18992

Figure 12 shows a laser warning label and an explanatory label for laser products. Explanatory labels may be provided in other languages. The explanatory label provides the following information:

- a warning that calls attention to the invisible laser radiation
- an instruction against staring into the beam or viewing directly with optical instruments
- wavelength
- normal output power
- maximum output power

Figure 12 Laser warning labels

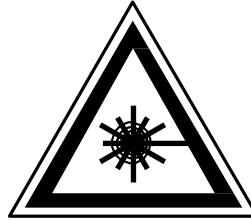

Laser Warning Label

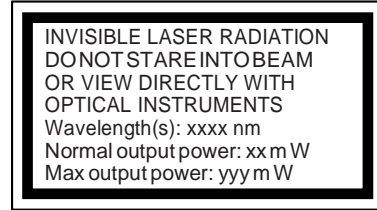

Laser Warning Label

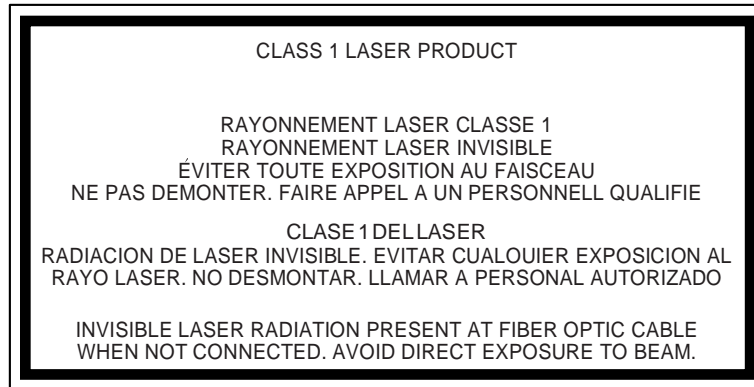

Laser Warning Label

18993

4.3.2 Laser classification

The ONT is classified as a Class 1 laser product based on its transmit optical output.

For Class 1 laser products, lasers are safe under reasonably foreseeable conditions of operation, including the use of optical instruments for intrabeam viewing.

Figure 13 shows a sample laser product safety label on the ONT equipment.

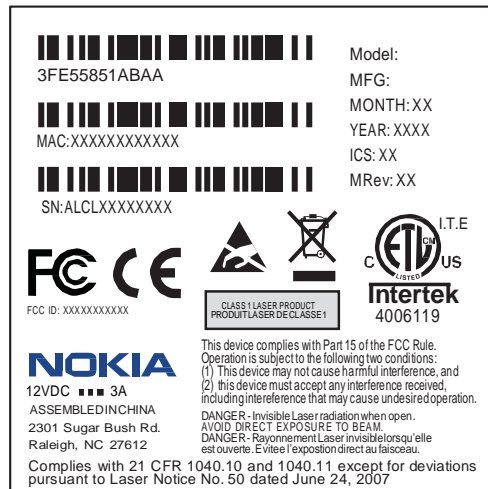
Figure 13 Sample laser product safety label on the ONT equipment

18532

4.3.3 Transmit optical output

The maximum transmit optical output of an ONT is +5 dBm.

4.3.4 Normal laser operation

In normal operation, fiber cable laser radiation is always off until it receives signal from the line terminal card.

Operating personnel must observe the instructions on the laser explanatory label before plugging in the optical module.



Danger — Risk of eye damage by laser radiation.

4.3.5 Location class

Use cable supports and guides to protect the receptacles from strain.

4.4 Electrical safety guidelines

This section provides the electrical safety guidelines for the ONT equipment.



Note — The ONTs comply with the U.S. National Electrical Code. However, local electrical authorities have jurisdiction when there are differences between the local and U.S. standards.

4.4.1 Power supplies

The use of any non-Nokia approved power supplies or power adapters is not supported or endorsed by Nokia. Such use will void any warranty or support contract with Nokia. Such use greatly increases the danger of damage to equipment or property.

4.4.2 Cabling

The following are the guidelines regarding cables used for the ONT equipment:

- Use only cables approved by the relevant national electrical code.
- Use cables suitable for outdoor use for outdoor installation of ONTs.
- The ONTs have been evaluated for use with external POTS wiring without primary protection that may not exceed 140 ft (43 m) in reach. However, the power cable must not exceed 100 ft (31 m).

4.4.3 Protective earth

Earthing and bonding of the ONTs must comply with the requirements of NEC article 250 or local electrical codes.

4.5 ESD safety guidelines

The ONT equipment is sensitive to ESD. Operations personnel must observe the following ESD instructions when they handle the ONT equipment.



Caution — This equipment is ESD sensitive. Proper ESD protections should be used when entering the TELCO Access portion of the ONT.

During installation and maintenance, service personnel must wear wrist straps to prevent damage caused by ESD.

Nokia recommends that you prepare the site before you install the ONT equipment. In addition, you must control relative humidity, use static dissipating material for furniture or flooring, and restrict the use of air conditioning.

4.6 Environmental requirements

See the ONT technical specification documentation for temperature ranges for ONTs.

During operation in the supported temperature range, condensation inside the ONT caused by humidity is not an issue. To avoid condensation caused by rapid changes in temperature and humidity, Nokia recommends:

- The door of the ONT not be opened until temperature inside and outside the enclosure has stabilized.
- If the door of the ONT must be opened after a rapid change in temperature or humidity, use a dry cloth to wipe down the metal interior to prevent the risk of condensation.
- When high humidity is present, installation of a cover or tent over the ONT helps prevent condensation when the door is opened.

5 G-240W-F unit data sheet

- 5.1** [G-240W-F part numbers and identification](#)
- 5.2** [G-240W-F general description](#)
- 5.3** [G-240W-F software and installation feature support](#)
- 5.4** [G-240W-F interfaces and interface capacity](#)
- 5.5** [G-240W-F LEDs](#)
- 5.6** [G-240W-F detailed specifications](#)
- 5.7** [G-240W-F GEM ports and T-CONTs](#)
- 5.8** [G-240W-F performance monitoring statistics](#)
- 5.9** [G-240W-F functional blocks](#)
- 5.10** [G-240W-F standards compliance](#)
- 5.11** [G-240W-F special considerations](#)

5.1 G-240W-F part numbers and identification

Table 3 provides part numbers and identification information for the G-240W-F indoor ONT.

Table 3 Identification of G-240W-F indoor ONTs

Ordering kit part number	Provisioning part number	Description	CLEI	CPR	ECI/Bar code

3FE 46649 AA	3FE 46597 AC	<p>Package S GPON indoor ONT with two POTS ports, four 10/100/1000 Base-T Ethernet interfaces, and one 100 mW Wi-Fi radio with on/off switch.</p> <p>This ONT features two USB 2.0 ports and supports SC/APC optics.</p> <p>Includes two 5dBI indoor multi-directional external WiFi antenna (not detachable), one 1.5m CAT-5E Ethernet cable with RJ-45 endpoint, and one 1.5m RJ-11 cable.</p> <p>Also includes one 2-pin wall-mounted 12V AC/DC power adapter with US plug.</p>	—	—	—
--------------	--------------	--	---	---	---

(1 of 3)

Ordering kit part number	Provisioning part number	Description	CLEI	CPR	ECI/Bar code
3FE 46649 AD Customer-specific	3FE 46597 AD	<p>Package S GPON indoor ONT with two POTS ports, four 10/100/1000 Base-T Ethernet interfaces, and one 100 mW Wi-Fi radio with on/off switch.</p> <p>This ONT features two USB 2.0 ports and supports SC/APC optics.</p> <p>Includes two 5dBI indoor multi-directional external WiFi antenna (not detachable), one 1.5m CAT-5E Ethernet cable with RJ-45 endpoint, and one 1.5m RJ-11 cable.</p> <p>Also includes one 2-pin wall-mounted 12V AC/DC power adapter with US plug.</p>	—	—	—
3FE 46649 BA	3FE 46597 AA	<p>Package S GPON indoor ONT with two POTS ports, four 10/100/1000 Base-T Ethernet interfaces, and one 100 mW Wi-Fi radio with on/off switch.</p> <p>This ONT features two USB 2.0 ports and supports SC/APC optics.</p> <p>Includes two 5dBI indoor multi-directional WiFi external antenna (not detachable), one 1.5m CAT-5E Ethernet cable with RJ-45 endpoint, and one 1.5m RJ-11 cable.</p> <p>Also includes one 2-pin wall-mounted 12V AC/DC power adapter with EU (European) plug.</p>	—	—	—
3FE 46649 BB Customer-specific	3FE 46597 AB	<p>Package S GPON indoor ONT with two POTS ports, four 10/100/1000 Base-T Ethernet interfaces, and one 100 mW Wi-Fi radio with on/off switch.</p> <p>This ONT features two USB 2.0 ports and supports SC/APC optics.</p> <p>Includes two 5dBI indoor multi-directional WiFi external antenna (not detachable), one 1.5m CAT-5E Ethernet cable with RJ-45 endpoint, and one 1.5m RJ-11 cable.</p> <p>Also includes one 2-pin wall-mounted 12V AC/DC power adapter with EU (European) plug.</p>	—	—	—
3FE 46649 BC Customer-specific	3FE 47087 AC	<p>Package S GPON indoor ONT with two POTS ports, four 10/100/1000 Base-T Ethernet interfaces, and one 200 mW Wi-Fi radio with on/off switch.</p> <p>This ONT features two USB 2.0 ports and supports SC/APC optics.</p> <p>Includes two 5dBI indoor multi-directional WiFi external antenna (not detachable), one 1.5m CAT-5E Ethernet cable with RJ-45 endpoint, and one 1.5m RJ-11 cable, and one 1m SC/UPC patch cord.</p> <p>Also includes one 2-pin wall-mounted 12V AC/DC power adapter with EU (European) plug.</p> <p>This variant features an enclosure that is suitable for up to 50°C</p>	—	—	—

(2 of 3)

Ordering kit part number	Provisioning part number	Description	CLEI	CPR	ECI/Bar code
3FE 46649 CA	3FE 46597 AA	Package S GPON indoor ONT with two POTS ports, four 10/100/1000 Base-T Ethernet interfaces, and one 100 mW Wi-Fi radio with on/off switch. This ONT features two USB 2.0 ports and supports SC/APC optics. Includes two 5dBI indoor multi-directional WiFi external antenna (not detachable), one 1.5m CAT-5E Ethernet cable with RJ-45 endpoint, and one 1.5m RJ-11 cable. Also includes one 3-pin wall-mounted 12V AC/DC power adapter with UK (British) plug.	—	—	—
3FE 47245 AA	3FE 47087 AA	Package S GPON indoor ONT with two POTS ports, four 10/100/1000 Base-T Ethernet interfaces, and one 200 mW Wi-Fi radio with on/off switch. This ONT features two USB 2.0 ports and supports SC/APC optics. Includes two 5dBI indoor multi-directional external WiFi antenna (not detachable), one 1.5m CAT-5E Ethernet cable with RJ-45 endpoint, and one 1.5m RJ-11 cable. Also includes one 2-pin wall-mounted 12V AC/DC power adapter with US plug.	—	—	—
3FE 47245 AB Customer-specific	3FE 47087 AB	Package S GPON indoor ONT with two POTS ports, four 10/100/1000 Base-T Ethernet interfaces, and one 200 mW Wi-Fi radio with on/off switch. This ONT features two USB 2.0 ports and supports SC/APC optics. Includes two 5dBI indoor multi-directional WiFi external antenna (not detachable), one 1.5m CAT-5E Ethernet cable with RJ-45 endpoint, and one 1.5m RJ-11 cable. Also includes one 2-pin wall-mounted 12V AC/DC power adapter with US plug.	—	—	—

(3 of 3)

For the G-240W-F indoor ONT power supply information, contact your Nokia technical support representative.

5.2 G-240W-F general description

G-240W-F indoor ONTs provide the subscriber interface for the network by terminating the PON interface and converting it to user interfaces that directly connect to subscriber devices. The ONT is compatible with all existing subscriber equipment, including analog phones with both tone and rotary dial capabilities, cordless phones, modems, fax machines, and caller ID boxes (Type I, Type II, and Type III).

G-240W-F indoor ONTs provide the following functions:

- single fiber GPON interface with 1.244Gbit/s upstream and 2.488Gbit/s downstream data rates
- 4 Ethernet LAN connections

- 2 POTS connections
- 2 USB 2.0 ports; voltage rate: 5V, current rate: 500mA per port
- reset button
- LED indicators on/off button
- WLAN enable/disable button
- WPS enable/disable button
- UPnP IGD2.0 support
- 2.4 GHz wireless interface
- 2 5dBI indoor multi-directional external WiFi antenna (not detachable)
- MIMO
- support for up to 20 concurrent wireless connections
- 802.11b/g/n compliant
- MDI/MDIX auto sensing
- auto-negotiation for speed and duplex
- multiple voice Codec
- echo cancellation
- Analog Telephone Adapter (ATA) function integrated based on SIP (RFC3261) with various CLASS services supported, including Caller ID, Call Waiting, Call Forwarding, and Call Transfer
- auto reconnect when connection to server is lost
- Network Address Translation (NAT)

5.2.1 TR-069 support

The ONT supports the reading of optical parameters via TR-069:

- laser bias current
- voltage
- temperature
- received signal levels
- lower thresholds

These are the same optical parameters supported in the GUI. For more information, see Table 21 in the chapter [“Configure a G-240W-F indoor ONT”](#).

The ONT supports the status retrieval and configuration of the following Wi-Fi parameters via TR-069:

- channel
- SSID
- password for WPA and WEP
- Tx power (transmission rate in dBm)

These are the same TR-069 object parameters that are supported in the GUI. For more information, see Tables 17 and 27 in the chapter “Configure a G-240W-F indoor ONT”.

The ONT also supports TR-069 statistics and troubleshooting for LAN, WAN, and WiFi.

5.2.2 TR-104 parameter extension support for voice service

A proprietary attribute has been added to the TR-104 Voice Service object structure to enable the ACS to configure the name of the embedded GSIP XML file to be selected.

The TR-104 Voice Service Object is:
InternetGatewayDevice.Services.VoiceService.{i}.Capabilities.SIP.

The proprietary attribute is: X_ALU-COM_XML_File_Name_Path.

5.2.3 Mobile offload support

As part of the E2E solution supported by the ISAM 7750 service router, the G-240W-F ONT offers Mobile Offload support using a combination of EAP-SIM and ITU-T 802.11.

EAP-SIM is an authentication method that uses the user credentials on the SIM card and EAP to authenticate the user with the Wi-Fi network, removing the need for user input (username and password).

A dedicated public mobile offload SSID in the ONT enables mobile subscribers to connect to the Internet. Encryption is supported by 802.11, providing seamless Wi-Fi authentication for SIM-based user equipment.

The ONT acts as the RADIUS client and sends the encapsulated EAP messages to the AAA server via the WLAN Gateway, which acts as the RADIUS proxy server. The interaction between the ONT and the AAA server provides subscriber management for authenticated mobile users without adding authentication load to the 3G network.

5.2.4 Bridged Residential Gateway (BRG) support

The BRG receives IP addresses for the WAN interface using DHCP or PPPoE. The BRG can use either Ipv4 or Ipv6 addresses. BRG uses OpenFlow protocol version 1.3.1 to manage Access Control List entries and routing protocols. TR-069 can be used to manage the local DHCP server and the soft GRE tunnel.

The BRG supports the encapsulation of Ethernet frames from different bridges in the GRE tunnel to the access tunnel. Multiple bridges can map to the same GRE tunnel. Where encapsulated packets exceed the MTU (packet size), fragmentation is also supported.

Upstream QoS can reserve bandwidth for public and private Wi-Fi bridges, based on profiles defined for the access uplink speed. A unique VLAN tag can be configured for each SSID on the BRG. Unicast QoS adjustment can be enabled to support Multicast IPTV

Liveness detection and redundancy, link failure notification, and DHCP local server fallback are provided to help manage potential problems with gateway access. Event notification via TR-069 reports when the PON link is up and the tunnel is unreachable.

5.3 G-240W-F software and installation feature support

For information on installing or replacing the G-240W-F see:

- [Install a G-240W-F indoor ONT](#)
- [Replace a G-240W-F indoor ONT](#)

For information on the following topics, see the *7368 ISAM ONT Product Overview Guide*:

- ONT and MDU general descriptions of features and functions
- Ethernet interface specifications
- POTS interface specifications
- RSSI specifications
- Wi-Fi specifications
- ONT optical budget
- SLID entry via Ethernet port
- ONT management using an ONT interface

5.4 G-240W-F interfaces and interface capacity

Table 4 describes the supported interfaces and interface capacity for G-240W-F indoor ONTs.

Table 4 G-240W-F indoor ONT interface connection capacity

ONT type and model	Maximum capacity								
	POTS	10/ 100 BASE-T	10/ 100/ 1000 BASE-T	RF video (CATV)	MoCA	VDSL2	E1/T1	Local craft	GPON SC/APC
G-240W-F (1)	2	—	4	—	—	—	—	—	1

Note

(1) The G-240W-F ONTs provide Wi-Fi service that is enabled and disabled using a Wi-Fi on/off switch.

5.4.1 G-240W-F connections and components

Figure 14 shows the physical connections on the back of the G-240W-F indoor ONT: USB, LAN, POTS, power input, and on/off button.

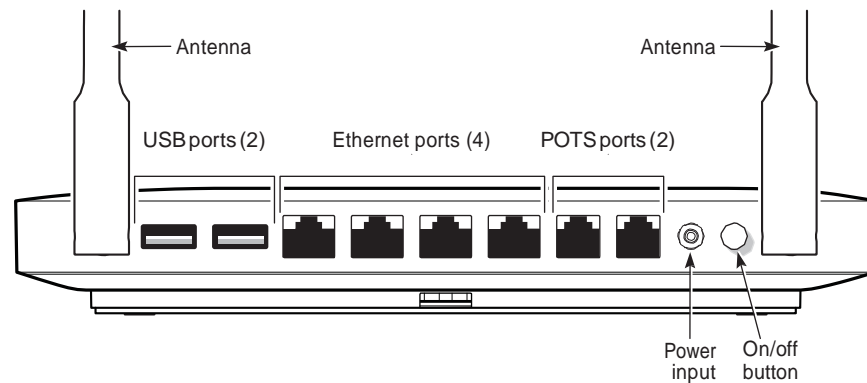
Figure 14 G-240W-F indoor ONT physical connections (back view)

26031

Figure 15 shows the buttons on the side of the G-240W-F indoor ONTs: reset, LED indicators on/off, WLAN enable/disable, and WPS enable/disable, as well as the fiber optic port on the bottom of the ONT.

Figure 15 G-240W-F ONT Reset, LED, WLAN, and WPS buttons and fiber optic connection (bottom and side view)

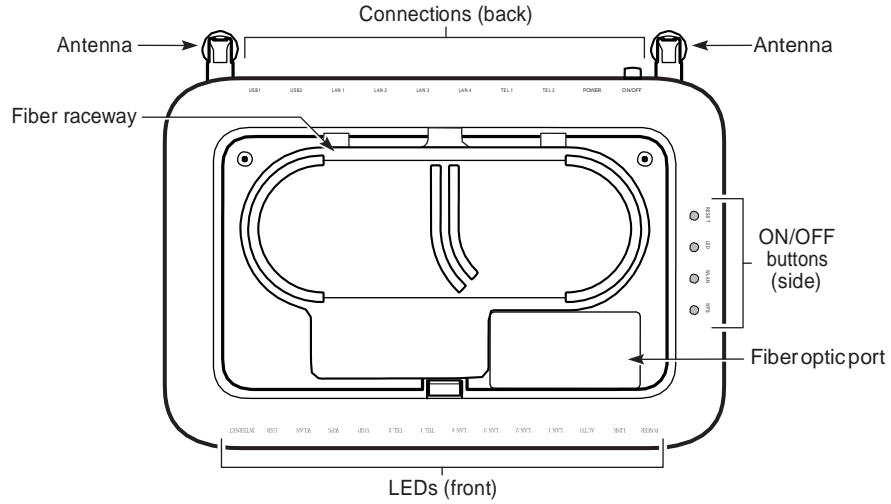

26032

Table 5 describes the physical connections for G-240W-F indoor ONTs.

Table 5 G-240W-F indoor ONT physical connections

Connection ⁽¹⁾	Description
USB (USB ports)	This connection is provided through two USB 2.0 ports on the back of the ONT. The voltage rate is 5V, and the current rate is 500mA per port.
LAN1-LAN4 (RJ-45 Ethernet ports)	This connection is provided through Ethernet RJ-45 connectors on the back of the ONT. Up to four 10/100/1000 Base-T Ethernet interfaces are supported. The Ethernet ports can support both data and in-band video services on all four interfaces.
TEL1, TEL2 (RJ-11 POTS ports)	This connection is provided through RJ-11 ports on the back of the ONT. Up to two POTS connections are supported. The POTS ports support voice services.
POWER (Power input)	This connection is provided through the power connector on the back of the ONT. A power cable fitted with a barrel connector is used to make the connection.
ON/OFF	This button on the side of the ONT turns the ONT on or off.
RESET	Pressing the Reset button, located on the side of the ONT, for less than 10 seconds reboots the ONT; pressing the Reset button for 10 seconds resets the ONT to the factory defaults, except for the LOID and SLID.
LED (LED indicator button)	This button, located on the side of the ONT, turns all LED indicators on or off.
WLAN (Wireless On/Off button)	Wi-Fi service is compliant with IEEE 802.11 standards and is enabled or disabled using the WLAN button on the side of the ONT.

(1 of 2)

Connection ⁽¹⁾	Description
WPS (Wi-Fi security button)	The Wi-Fi Protected Setup (WPS) button, located on the side of the ONT, enables and disables WLAN data encryption.
PON (Fiber optic port)	This connection, on the bottom of the ONT, is provided through an SC/APC fiber optic connector.

(2 of 2)

Note

(1) The primary path for the earth ground for these ONTs is provided by the 12V Return signal in the power connector.

5.5 G-240W-F LEDs

Figure 16 shows the G-240W-F indoor ONT LEDs.

Figure 16 G-240W-F indoor ONT LEDs

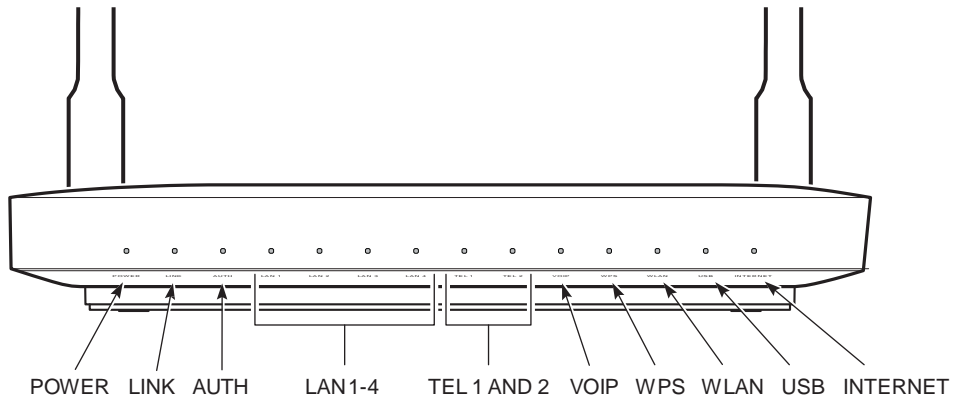

26035

Table 6 provides LED descriptions for G-240W-F indoor ONTs.

Table 6 G-240W-F indoor ONT LEDs

Indicator	LED color and behavior	LED behavior description
Power	Green solid Red solid Off	Power on Light failed on startup (for example corrupt flash), or self test failed on startup, or self test failed during regular operation or when executed over OMCI Power off
Link	Green solid Off	GPON link between ONT and OLT is operating normally GPON link is down or no link connected

(1 of 2)

Indicator	LED color and behavior	LED behavior description
Auth	Green solid Green flashing Off	ONT is authorized ONT is In process of ranging or synchronizing on OMC1 ONT is not authorized
LAN 1 to 4	Green solid Green flashing Off	Ethernet is linked LAN activity is present (in either direction) ONT power off or Ethernet not connected
TEL 1 to 2	Green solid Green flashing Off	Phone off hook Phone in 'call in' or 'talking' condition Phone on hook
VOIP	Green solid Off	VOIP service is built up and can provide service VOIP service is not built up or out of service
WPS	Green solid Green flashing Off	WiFi protected setup link is up (negotiation and auto-configuration successful) WiFi protected setup link activity (negotiation and auto-configuration ongoing) WiFi protected setup link down or no link connected (negotiation has not started or has failed)
WLAN	Green solid Green flashing Off	WLAN link is up (wireless enabled) WLAN activity (traffic on wireless link) WLAN link is down or no link is connected
USB	Green solid Green flashing Off	At least one USB device is connected Traffic activity on at least on USB device No USB device connected
INTERNET	Green solid Green flashing Off	HSI WAN is connected: a) the device has an IP address assigned from IPCP, DHCP, or static, and no traffic has been detected; b) the session is dropped due to idle timeout but the PON link is still present. PPPoE or DHCP connection in progress HSI WAN is not connected: a) there is no physical interface connection; b) the device is in bridged mode without an assigned IP address; c) the session has been dropped for reasons other than idle timeout.

(2 of 2)

5.6 G-240W-F detailed specifications

Table 7 lists the physical specifications for G-240W-F indoor ONTs.

Table 7 G-240W-F indoor ONT physical specifications

Description	Specification
Width	8.1 in. (205 mm)
Length	6 in. (152 mm) 7 in. (176 mm with antenna)
Height	1.3 in. (33 mm)
Weight [within ± 0.5 lb (0.23 kg)]	0.88 lb (0.4 kg)

Table 8 lists the power consumption specifications for G-240W-F indoor ONT.

Table 8 G-240W-F indoor ONT power consumption specifications

Maximum power (Not to exceed)	Condition	Minimum power	Condition
13.6 W	2 POTS off-hook, 4 10/100/1000 Base-T Ethernet, Wi-Fi operational	3.06 W	2 POTS on-hook, other interfaces/services not provisioned

Table 9 lists the environmental specifications for G-240W-F indoor ONT.

Table 9 G-240W-F indoor ONT environmental specifications

Temperature range and humidity	Altitude
Operating: 23°F to 113 F (-5°C to 45°C) ambient temperature 5% to 95% relative humidity, non-condensing	Contact your Nokia technical support representative for more information
Storage: -4°F to 158°F (-20°C to 70C)	

5.7 G-240W-F GEM ports and T-CONTs

Table 10 lists the maximum number of supported T-CONTs and GEM ports.

Table 10 G-240W-F indoor ONT capacity for GEM ports and T-CONTs

GEM ports or TCONTs	Maximum	Notes
GEM ports per indoor or outdoor ONT	256	254 are present; 122 are available, and 2 are reserved for multicast and debugging
T-CONTs per indoor or outdoor ONT	32	32 are present; 31 are available, and 1 is reserved for OMC1

5.8 G-240W-F performance monitoring statistics

The following section identifies the supported performance monitoring statistics for G-240W-F ONTs. A check mark indicates the statistic is supported on that ONT. An empty cell indicates the statistic is not supported. The following tables are categorized by supported alarm types:

- Table 11 provides statistics for ONTENET type counters
- Table 12 provides statistics for ONTL2UNI type counters

- Table 13 provides statistics for PONONTTC, PONONTMCTC, PONONTTCHSI, PONONTTCCES, PONONTTCFLOW, and PONONTTCVOIP type counters
- Table 14 provides statistics for PONONTTC aggregate type counters



Note — If you have trouble accessing G-240W-F ONTs performance monitoring statistics using TL1, please contact your Nokia support representative for more information about how to access and retrieve performance monitoring type counters.

Table 11 Package S ONTs ONTENET performance monitoring statistics

ONT	ONTENET statistics													
	FCSE	EC	LC	RBO	SCF	MCF	DT	IMTE	CSE	AE	IMRE	FTL	TBO	SQE
G-240W-F ⁽¹⁾	✓	✓	✓	✓	✓	✓	✓	✓	✓	✓	✓	✓	✓	✓

Note

⁽¹⁾ A 5 second polling window limitation exists on the ONT, therefore the margin of error for each 15-min window is 5 seconds

Table 12 Package S ONTs ONTL2UNI performance monitoring statistics

ONT	ONTL2UNI statistics										
	FRAMES	BYTES	MCFRAMES	DSDRPFRRMS	USDRPFRRMS	USFRAMES	DSFRAMES	USBYTES	DSBYTES	USMCFRAMES	DSMCFRAMES
G-240W-F ⁽¹⁾	✓	✓	✓	✓	✓	✓	✓	✓	✓	✓	✓

Note

⁽¹⁾ A 5 second polling window limitation exists on the ONT, therefore the margin of error for each 15-min window is 5 seconds

Table 13 Package S ONTs PONONTTC, PONONTMCTC, PONONTTCHSI, PONONTTCCES, PONONTTCFLOW, PONONTTCVOIP performance monitoring statistics

ONT	PONONTTC, PONONTMCTC, PONONTTCHSI, PONONTTCCES, PONONTTCFLOW, PONONTTCVOIP statistics					
	TXBLOCKS	TXFRAGS	RXBLOCKS	RXFRAGS	LOSTFRAGS	BADGEMHDRS
G-240W-F ⁽¹⁾	✓	✓	✓	✓	✓	

Note

⁽¹⁾ A 5 second polling window limitation exists on the ONT, therefore the margin of error for each 15-min window is 5 seconds

Table 14 Package S ONTs PONONTTC aggregate performance monitoring statistics

ONT	PONONTTC (aggregate) statistics					
	TXBLOCKS	TXFRAGS	RXBLOCKS	RXFRAGS	LOSTFRAGS	BADGEMHDRS
G-240W-F ⁽¹⁾	✓	✓	✓	✓	✓	

Note

⁽¹⁾ A 5 second polling window limitation exists on the ONT, therefore the margin of error for each 15-min window is 5 seconds

5.9 G-240W-F functional blocks

G-240W-F indoor ONTs are single-residence ONTs that support Wireless (Wi-Fi) service. Wi-Fi services on these ONTs are compliant with the IEEE 802.11 standard and enabled or disabled using a WLAN button. In addition to the Wi-Fi service, these ONTs transmit Ethernet packets to four RJ-45 Ethernet ports and voice traffic to two RJ-11 POTS ports. These ONTs also feature fiber optic, USB, and power connectors.

Figure 17 shows the functional blocks for G-240W-F indoor ONT.

Figure 17 Single-residence Wi-Fi ONT with Gigabit Ethernet and POTS and without RF video

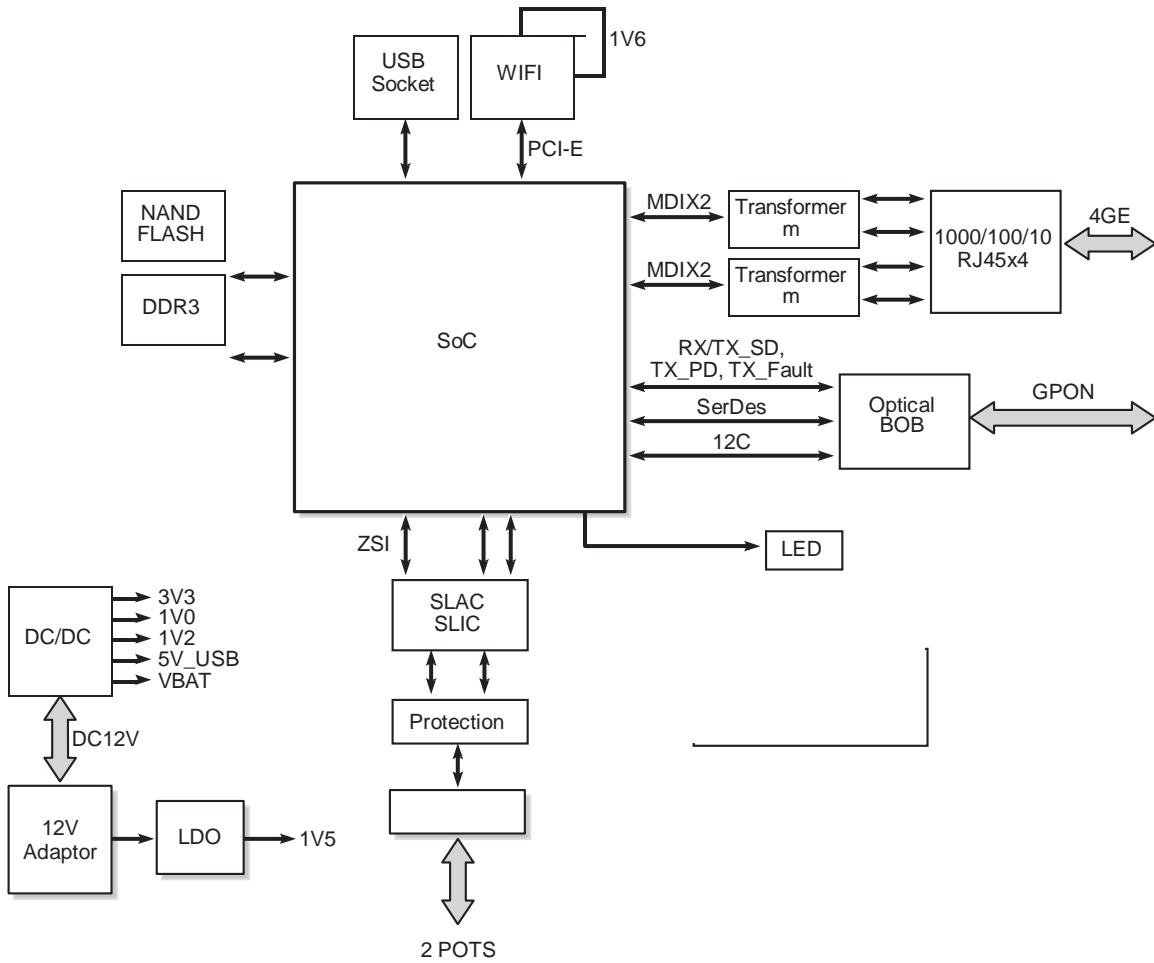

26037

ONT SoC technology serves as the main hardware block for these ONTs; see Figure 18.

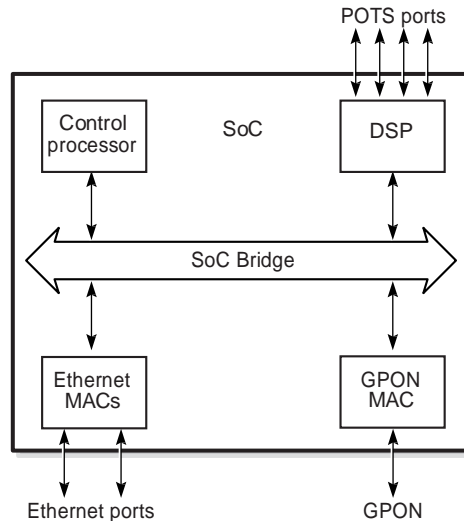
Figure 18 G-240W-F ONT hardware block

19421

ONT SoC technology consists of five key elements:

- **GPON MAC**
The Gigabit Passive Optical Network Media Access Control (GPON MAC) element on the SoC terminates the GPON interface using an optical diplexer. This interface supports GPON as described in G.984.3 (GPON TC Layer) ITU specification.
- **Ethernet MAC**
The SoC provides up to four GE MACs.
- **DSP interface**
The Digital Signal Processor (DSP) provides voice processing for 2 POTS lines with 3-way calling. The DSP has a dedicated 64 kbyte instruction cache and shares a 32 kbyte data cache with the Control Processor. It provides up to 4 network processor cores, each at 800MHz.
- **Control Processor**
The Control Processor features an integral memory management unit that supports a dedicated 64 kbyte instruction cache and shares a single 32 kbyte data cache with the DSP. The Control Processor and DSP also include a single channel Data Management Application (DMA) controller with a 4 kbyte read ahead low-latency Dynamic Random Access Memory (DRAM) access port. The processors typically run at 600 MHz.
- **Switch matrix**
The Switch matrix provides an integrated data channel between the four GE MACs, the GPON MAC, the DSP, the control processor, and the other integrated elements such as flash memory, DRAM, and the local bus controller.

These ONTs can also interact with additional hardware components to support functionality not provided by the SoC technology.

5.10 G-240W-F standards compliance

G-240W-F indoor ONTs are compliant with the following standards:

- 802.1p QoS
- 802.1q VLANs
- 802.3 auto negotiation, flow control
- 802.11 b/g/n at 2.4 GHz
- Codec G.711 a/u, G.722, G.723, G.726, G.729
- EN 300-328 v1.9.1 wide band data transmission standards for 2.4GHz bands
- Energy Star standards. Level 6
- EU CoC v5 broadband communication
- G.984 support GPON interface (framing)
- G.984.2 support for Amd1, class B+
- G.984.3 support for activation and password functions
- G.984.3 support for AES with operator enable/disable on per port-ID level
- G.984.3 support for FEC in both upstream and downstream directions
- G.984.3 support for multicast using a single GEM Port-ID for all video traffic
- G984.4 and G.983.2 support for OMCI v1 and v2 interface for ONT management and provisioning
- SIPv2 RFC 3261 signaling

Figure 19 shows the product label for the G-240W-F ONT.

Figure 19 G-240W-F ONT product label

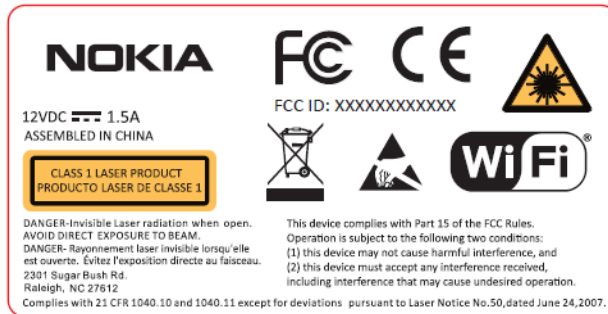

Figure 20 shows an example of the safety label for the G-240W-F ONT.

Figure 20 G-240W-F ONT safety label

5.10.1 Energy-related products standby and off modes compliance

Hereby, Nokia declares that the G-240W-F ONTs are in compliance with the essential requirements and other relevant provisions of Directive 2009/125/EC together with Commission Regulation (EC) No 1275/2008 and Commission Regulation (EC) No 801/2013.

The G-240W-F ONTS qualify as equipment with high network availability (HiNA) functionality. Since the main purpose of G-240W-F ONTs is to provide network functionality with HiNA 7 days /24 hours, the modes Off/Standby, Power Management, and Networked Standby are inappropriate.

For information about the type and number of network ports, see [“G-240W-F interfaces and interface capacity”](#) in this chapter.

For information about power consumption, see [“G-240W-F detailed specifications”](#) in this chapter.

5.11 G-240W-F special considerations

G-240W-F is a Package S ONT.

5.11.1 Wi-Fi service

G-240W-F indoor ONTs feature Wi-Fi service as well as voice and data services. Wi-Fi is a wireless networking technology that uses radio waves to provide wireless HSI and network connections. This ONT complies with the IEEE 802.11 standards, which the Wi-Fi Alliance defines as the basis for Wi-Fi technology.

5.11.1.1 Wi-Fi physical features

G-240W-F indoor ONTs have the following physical features that assist in providing Wi-Fi service:

- WLAN button for enabling and disabling Wi-Fi service
- two external multi-directional antennae
- Wi-Fi Protected Setup (WPS) push button for enabling and disabling wireless protective services

5.11.1.2 Wi-Fi standards and certifications

The Wi-Fi service on G-240W-F indoor ONTs supports the following IEEE standards and Wi-Fi Alliance certifications:

- certified for IEEE 802.11b/g/n standards
- WPA support including WPA-PSK
- certified for WPA2-Personal and WPA2-Enterprise

5.11.1.3 Wi-Fi GUI features

G-240W-F indoor ONTs have HTML-based Wi-Fi configuration GUIs.

5.11.2 G-240W-F ONT considerations and limitations

Table 15 lists the considerations and limitations for Package S G-240W-F ONTs.

Table 15 G-240W-F ONT considerations and limitations

Considerations and limitations
Do not put the metallic material plate on top of the enclosure.
Call History Data collection (ONTCALLHST) is supported, except for the following parameters: RTP packets (discarded), far-end RTCP and RTCP-XR participation, RTCP average and peak round trip delay, MOS, average jitter, number of jitter-buffer over-runs and under runs.
Some voice features are configurable on a per ONT basis, including Call Waiting, Call Hold, 3-Way Calling, and Call Transfer.

(1 of 2)

Considerations and limitations

The following voice features / GSIP parameters are configurable on a per-Client/ per-ONT basis (not per-Subscriber):

- Enable Caller ID and Enable Caller Name ID
- Digitmap and the associated Interdigit and Critical timers and Enter key parameters
- Warmline timer is enabled per subscriber, but the warmline timer value is configured per ONT and must have a lower value than the Permanent time
- Miscellaneous timers: Permanent, Timed-release, Reanswer, Error-tone, and CW-alert timers
- Features / functions: Message waiting mode, WMWI refresh interval, DTMF volume level
- Service Codes for the following features: CCW, Call Hold and Warmline

(2 of 2)

6 Install a G-240W-F indoor ONT

6.1 Purpose

6.2 General

6.3 Prerequisites

6.4 Recommended tools

6.5 Safety information

6.6 Procedure

6.1 Purpose

This chapter provides the steps to install a G-240W-F indoor ONT.

6.2 General

The steps listed in this chapter describe mounting and cabling for G-240W-F indoor ONTs.

6.3 Prerequisites

You need the following items before beginning the installation:

- all required cables

6.4 Recommended tools

You need the following tools for the installation:

- #2 Phillips screwdriver
- 1/4 in. (6 mm) flat blade screwdriver
- wire strippers
- fiber optic splicing tools
- RJ-45 cable plug crimp tool
- voltmeter or multimeter
- optical power meter

- drill and drill bits
- paper clip

6.5 Safety information

Read the following safety information before installing the unit.



Danger 1 — Hazardous electrical voltages and currents can cause serious physical harm or death. Always use insulated tools and follow proper safety precautions when connecting or disconnecting power circuits.

Danger 2 — Make sure all sources of power are turned off and have no live voltages present on feed lines or terminals. Use a voltmeter to measure for voltage before proceeding.

Danger 3 — Always contact the local utility company before connecting the enclosure to the utilities.



Warning — This equipment is ESD sensitive. Proper ESD protections should be used when removing the fiber access cover of the indoor ONT.



Caution — Keep indoor ONTs out of direct sunlight. Prolonged exposure to direct sunlight can damage the unit.



Note 1 — Observe the local and national laws and regulations that may be applicable to this installation.

Note 2 — Observe the following:

- The indoor ONT should be installed in accordance with the applicable requirements of the NEC or CEC. Local authorities and practices take precedent when there is conflict between the local standard and the NEC or CEC.
- The indoor ONT must be installed by qualified service personnel.
- Indoor ONTs must be installed with cables that are suitably rated and listed for indoor use.
- See the detailed specifications in the [G-240W-F unit data sheet](#) for the temperature ranges for these ONTs.

6.6 Procedure

Use this procedure to install a G-240W-F indoor ONT.

1 Place the indoor ONT unit:

- a On the flat surface, such as a desk or shelf; go to step 3.



Note — The G-240W-F cannot be stacked with another ONT or with other equipment. The ONT mounting requirements are:

- allow a minimum 100 mm clearance above the top cover
- allow a minimum 50 mm clearance from the side vents
- do not place any heat source directly above the top cover or below the bottom cover

- b On a wall; go to step 2.

2 Mount the G-240W-F indoor ONT on a wall.

- i The G-240W-F indoor ONT can be mounted in either a horizontal or vertical position.

Figure 21 shows the wall mounting holes for the G-240W-F ONTs.

Figure 21 G-240W-F indoor ONT wall mounting holes (bottom view)

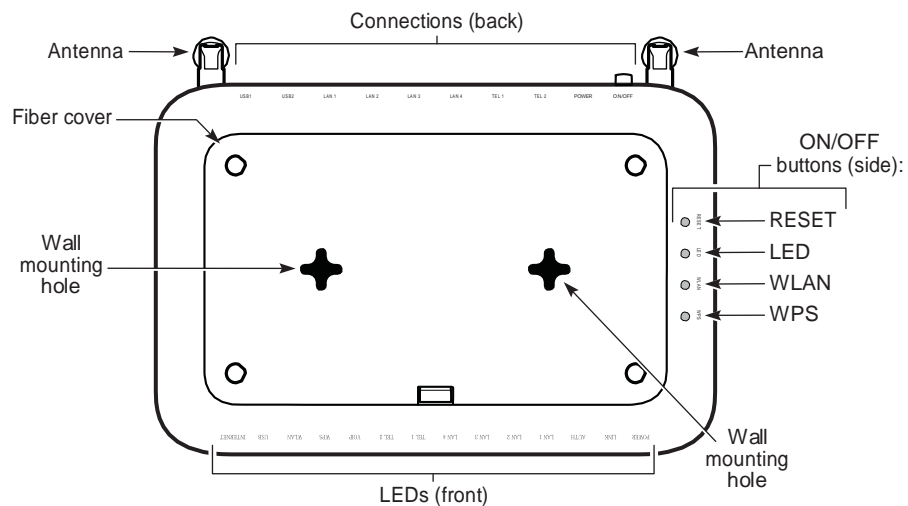

26033

If possible, mount the ONT on a wall stud

- ii Mark the wall with the location of the mounting holes. These holes should be the same distance apart as the distance between the centers of the keyholes on the ONT.

- iii Drill the two holes in the wall where the ONT will be mounted and then drive the mounting screws into the holes.

The recommended length of mounting screw is 1.15 in. (3.8 cm).

Do not drive the screw into the wall completely. Leave approximately 1/8 in. (6 mm) between the screw head and the wall surface.

- iv Slide the wall mount keyholes on the ONT enclosure down over the mounting screws until the ONT is securely seated.

- 3 Review the connection locations as shown in Figures 22 and 23.

Figure 22 G-240W-F indoor ONT connections (back view)

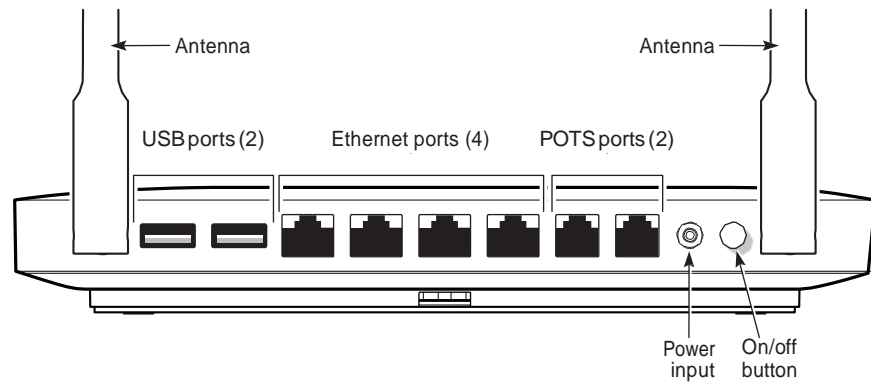

26031

Figure 23 G-240W-F ONT Reset, LED, WLAN, and WPS buttons and fiber optic connection (bottom and side view)

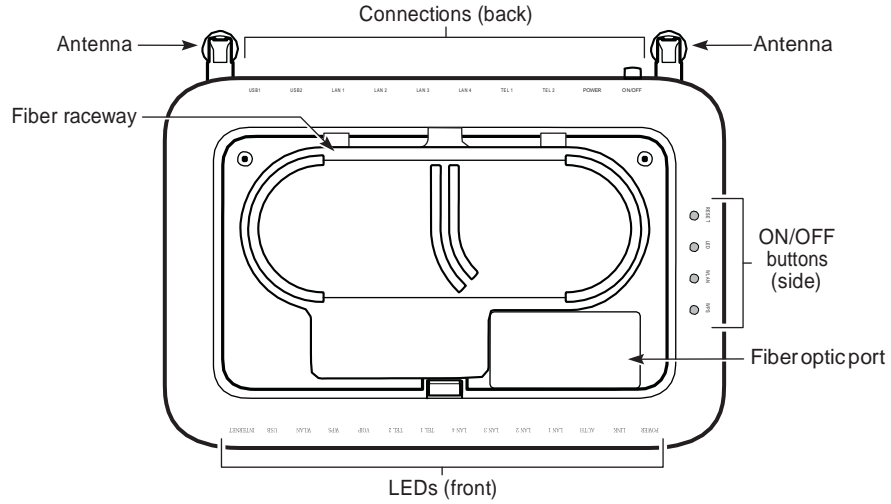

26032

The G-240W-F ONT features a fiber cover to protect the fiber optic cable and connection, as shown in Figure 24.

Figure 24 G-240W-F indoor ONT with fiber cover open

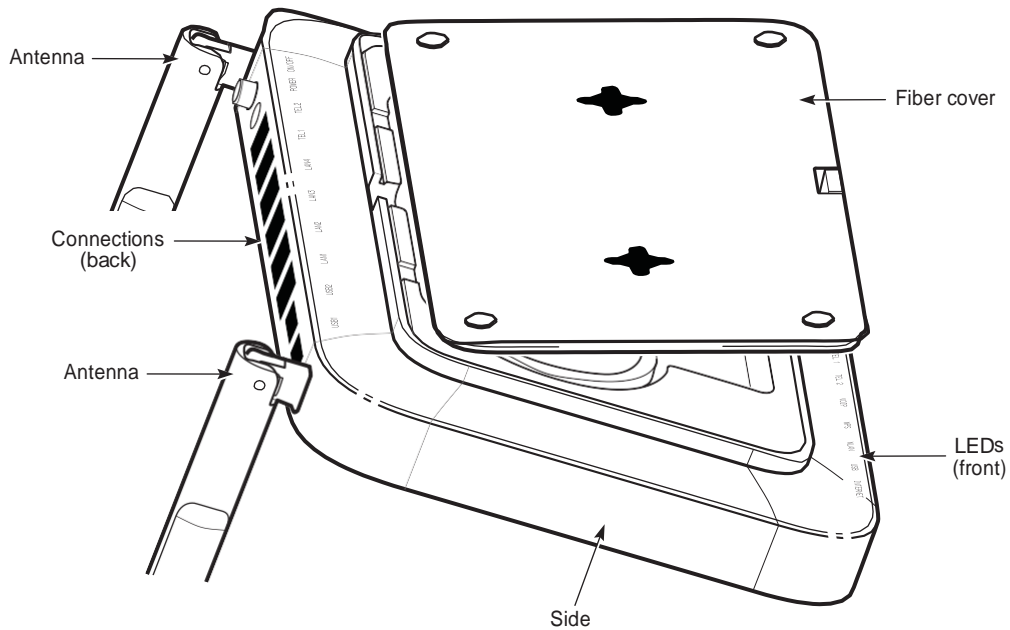

26034

4 Connect the Ethernet cables to the RJ-45 ports; see Figure 22 for the location of the RJ-45 ports.

5 Route the POTS cables directly to the RJ-11 ports as per local practices.

The POTS port to the left is labeled 1 for Line 1 while the port on the right is labeled 2 for Line 2, as shown in Figure 22.

6 Connect the fiber optic cable with SC/APC adapter into the SC/APC connector on the bottom of the ONT; see Figure 23 for the location of the SC/APC connector.



Danger — Fiber cables transmit invisible laser light. To avoid eye damage or blindness, never look directly into fibers, connectors, or adapters.



Warning — Be careful to maintain a bend radius of no less than 1.5 in. (3.8 cm) when connecting the fiber optic cable. Too small of a bend radius in the cable can result in damage to the optic fiber.



Note — Fiber cable preparation varies depending on the type and size of the inside or outside plant fiber cable being spliced to the SC/APC (SC/UPC) fiber optic pigtail cable.

7 Install the power supply according to manufacturer specifications.



Note — Observe the following:

- Units must be powered by a Listed or CE approved and marked limited power source power supply with a minimum output rate of 12 V dc, 1.25 A.

8 Connect the power cable to the power connector.

9 Power up the ONT unit by using the power on/off switch.

10 If used, enable the Wi-Fi service.

- i Locate the WLAN button on the side of the ONT; see Figure 23 for location of the WLAN button.
- ii Press the WLAN button to change the status of the Wi-Fi service.

-
- 11** If used, enable the WPS.
 - i** Locate the WPS button on the side of the ONT; see Figure 23 for location of the WPS button.
 - ii** Press the WPS button to change the status of the WPS.

 - 12** Verify the ONT LEDs, voltage status, and optical signal levels; see the *7368 Hardware and Cabling Installation Guide*.

 - 13** Activate and test the services; see the *7368 Hardware and Cabling Installation Guide*.

 - 14** If used, configure the SLID; see the *7368 ISAM ONT Configuration, Management, and Troubleshooting Guide*.

 - 15** If necessary, reset the ONT.
 - i** Locate the Reset button on the side of the G-240W-F indoor ONT as shown in Figure 23.
 - ii** Insert the end of a straightened paper clip or other narrow object into the hole in the Reset button to reset the ONT.

 - 16** STOP. This procedure is complete.

7 Replace a G-240W-F indoor ONT

7.1 Purpose

7.2 General

7.3 Prerequisites

7.4 Recommended tools

7.5 Safety information

7.6 Procedure

7.1 Purpose

This chapter provides the steps to replace G-240W-F indoor ONTs.

7.2 General

The steps listed in this chapter describe mounting and cabling for G-240W-F indoor ONTs.

7.3 Prerequisites

You need the following items before beginning the installation:

- all required cables

7.4 Recommended tools

You need the following tools for replacing the ONT:

- #2 Phillips screwdriver
- 1/4 in. (6 mm) flat blade screwdriver
- wire strippers
- fiber optic splicing tools
- RJ-45 cable plug crimp tool
- voltmeter or multimeter

- optical power meter
- drill and drill bits

7.5 Safety information

Read the following safety information before replacing the unit.



Danger 1 — Hazardous electrical voltages and currents can cause serious physical harm or death. Always use insulated tools and follow proper safety precautions when connecting or disconnecting power circuits.

Danger 2 — Make sure all sources of power are turned off and have no live voltages present on feed lines or terminals. Use a voltmeter to measure for voltage before proceeding.

Danger 3 — Always contact the local utility company before connecting the enclosure to the utilities.



Warning — This equipment is ESD sensitive. Proper ESD protections should be used when removing the fiber access cover of the indoor ONT.



Caution — Keep indoor ONTs out of direct sunlight. Prolonged exposure to direct sunlight can damage the unit.



Note 1 — Observe the local and national laws and regulations that may be applicable to this installation.

Note 2 — Observe the following:

- The indoor ONT should be installed in accordance with the applicable requirements of the NEC or CEC. Local authorities and practices take precedent when there is conflict between the local standard and the NEC or CEC.
- The indoor ONT must be installed by qualified service personnel.
- Indoor ONTs must be installed with cables that are suitably rated and listed for indoor use.
- See the detailed specifications in the [G-240W-F unit data sheet](#) for the ONT temperature ranges for these ONTs.

7.6 Procedure

Use this procedure to replace a G-240W-F indoor ONT.

1 Deactivate the ONT services at the P-OLT.

If you are using the SLID feature, this step is not required. The ONT and the services can remain in service (IS).

- i Use the RTRV-ONT command to verify the ONT status and th associated services. Record the serial number or the SLID of the ONT displayed in the command output.

Example:

```
RTRV-ONT::ONT-1-1-1-1-1;
```

- ii If the ONT is in service, place the ONT in OOS state.

Example:

```
ED-ONT::ONT-1-1-1-1-1::OOS;
```

2 If used, disable the Wi-Fi service by pressing the WLAN button; see Figure 25 for the location of the WLAN button on the side of the ONT.

Figure 25 G-240W-F indoor ONT Reset, LED, WLAN, and WPS buttons (side)

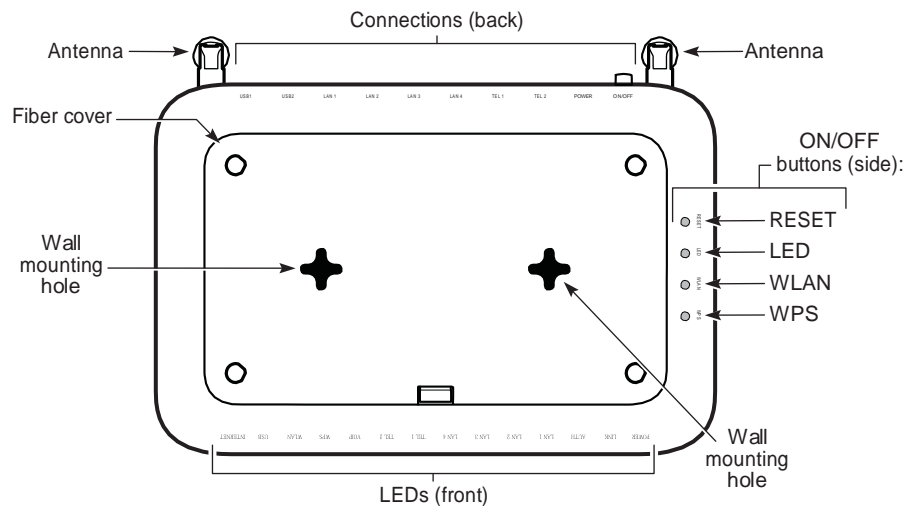

26033

3 Power down the unit by using the on/off power switch; see Figure 26 for the location of the power switch.

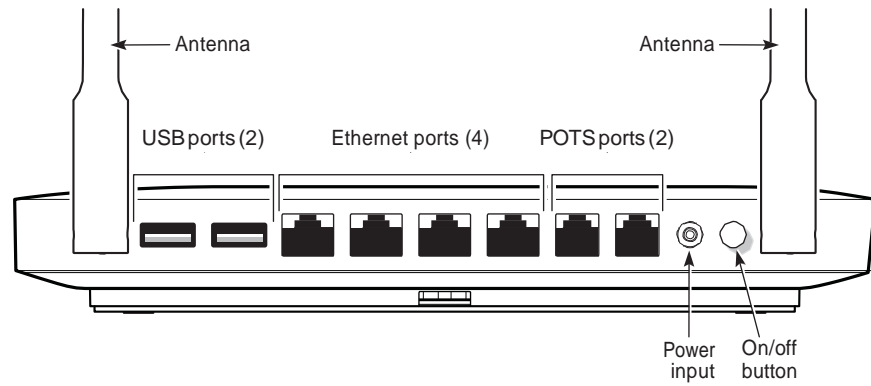
Figure 26 G-240W-F indoor ONT connections (back view)

26031

- 4 Disconnect the POTS, Ethernet, and power cables from the ONT; see Figure 26 for the connector locations on the G-240W-F indoor ONT.
- 5 Disconnect the fiber optic cable; see Figure 27 for the location of the fiber optic port on the bottom of the ONT..

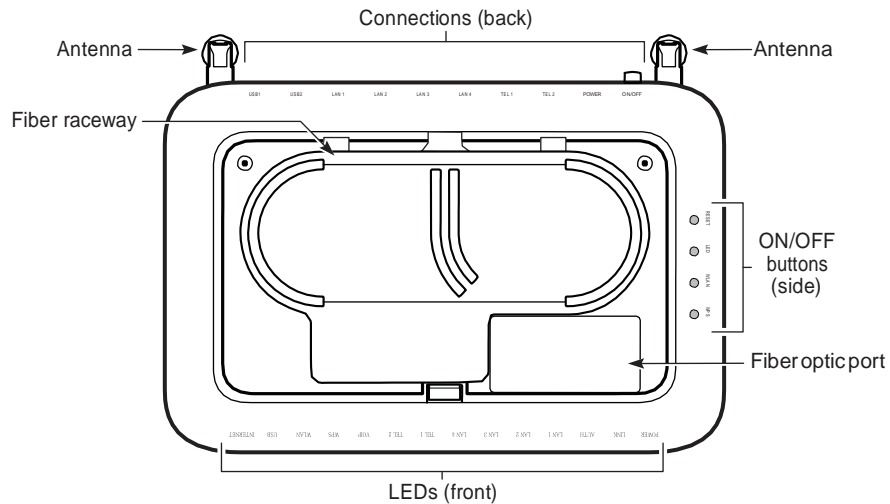
Figure 27 G-240W-F indoor ONT fiber optic port (bottom view)

26032



Danger — Fiber cables transmit invisible laser light. To avoid eye damage or blindness, never look directly into fibers, connectors, or adapters.

- i Unplug the fiber optic cable with SC/APC connector from the fiber optic port on the bottom of the ONT; see Figure 27 for the location of the fiber optic port.
- ii Attach a fiber dust cover to the end of the SC/APC (SC/UPC) connector.

6 Replace the ONT with a new unit:

- a On a flat surface, such as a desk or shelf, substitute the new ONT for the old ONT, horizontally resting on its four feet.
- b On a wall.
 - i Slide the old ONT off of the mounting screws until the ONT is free of the wall.
 - ii Slide the wall mount holes on the ONT enclosure over the mounting screws until it is securely seated.

7 Connect the Ethernet cables directly to the RJ-45 ports; see Figure 26 for the location of the RJ-45 ports.

8 Connect the POTS cables directly to the RJ-11 ports as per local practices; see Figure 26 for the location of the RJ-11 ports.

The RJ-11 port to the left is labeled 1 for Line 1 while the port on the right is labeled 2 for Line 2.

-
- 9 If required, have approved service personnel who are trained to work with optic fiber clean the fiber optic connection. See the *7368 ISAM ONT Configuration, Management, and Troubleshooting Guide* for more information about fiber optic handling, inspection, and cleaning.
-
- 10 Connect the fiber optic cable with SC/APC adapter into the SC/APC connector on the bottom of the ONT. Figure 27 shows the location of the SC/APC connector.



Danger — Fiber cables transmit invisible laser light. To avoid eye damage or blindness, never look directly into fibers, connectors, or adapters.



Warning — Be careful to maintain a bend radius of no less than 1.5 in. (3.8 cm) when connecting the fiber optic cable. Too small of a bend radius in the cable can result in damage to the optic fiber.



Note — Fiber cable preparation varies depending on the type and size of the inside or outside plant fiber cable being spliced to the SC/APC fiber optic pigtail cable.

-
- 11 Install the power supply according to manufacturer specifications.



Note — Observe the following:

- Units must be powered by a Listed or CE approved and marked limited power source power supply with a minimum output rate of 12 V dc, 1.25 A.

-
- 12 Connect the power cable to the power connector.

-
- 13 Power up the unit by using the power switch.

-
- 14 If used, enable the Wi-Fi service by pressing the WLAN button on the side of the ONT; see Figure 25 for the location of the WLAN button.

-
- 15 If used, enable the WPS by pressing the WPS button on the side of the ONT; see Figure 25 for the location of the WPS button.

- 16** If used, configure the SLID; see the *7368 ISAM ONT Configuration, Management, and Troubleshooting Guide* for more information.



Note — A new SLID or the old SLID may be used with the replacement ONT. If a new SLID is used, the new SLID must also be programmed at the P-OLT using TL1 or a network manager. If the old SLID is used, no changes need to be made at the P-OLT; see the operations and maintenance documentation for the OLT for more details.

- 17** Verify the ONT LEDs, voltage status, and optical signal levels; see the *7368 Hardware and Cabling Installation Guide*.

- 18** Activate and test the services; see the *7368 Hardware and Cabling Installation Guide*.

- 19** If necessary, reset the ONT.

- i Locate the Reset button on the side of the G-240W-F indoor ONT as shown in Figure 25.
- ii Insert the end of a straightened paper clip or other narrow object into the hole in the Reset button to reset the ONT.

- 20** STOP. This procedure is complete.
-

8 Configure a G-240W-F indoor ONT

8.1 General

8.2 HGU mode GUI configuration

8.3 SFU mode GUI configuration

8.4 Operator ID

8.1 General

Please refer to the configuration information provided with your OLT for the software configuration procedure for a G-240W-F ONT.

For HTTP configuration procedures, please refer to the *7368 ISAM ONT Configuration, Management, and Troubleshooting Guide*.

8.2 HGU mode GUI configuration

Use the procedures below to use the web-based GUI for the G-240W-F in HGU mode. This mode is preset at delivery.

A home gateway unit (HGU) is a home networking device, used as a gateway to connect devices in the home through fiber to the Internet. An HGU provides a variety of features for the home network including routing and firewall capability. By using the HGU, users can connect all smart equipment in their home, including personal computers, set-top boxes, mobile phones, and other consumer electronics devices, to the Internet.

8.2.1 Login

Use the procedure below to login to the web-based GUI for the G-240W-F.

Procedure 6 Login to web-based GUI

- 1 Open a web browser and enter the IP address of the ONT in the address bar.

The login window appears.

The default gateway IP address is `http://192.168.1.254`. You can connect to this IP address using your web browser after connecting your PC to one of Ethernet ports of the ONT. The static IP address of your PC must be in the same subnet as the ONT.

-
- 2 Enter your username and password in the Log in window, as shown in Figure 28.

The default user name is `userAdmin`. The default password is a random number, which is included in the ONT kit.

Figure 28 Web login window

The screenshot shows a web login window with a teal header. Below the header, there are two input fields: 'Username' and 'Password'. At the bottom of the window, there are two buttons: 'Login' and 'Reset'.



Caution — Pressing the Reset button for less than 10 seconds reboots the ONT; pressing the Reset button for 10 seconds resets the ONT to the factory defaults, except for the LOID and SLID.



Note — If you forget the current username and password, press the reset button for 10 s and the default values for the username and password will be recovered at startup.

-
- 3 Click Login.
-
- 4 STOP. This procedure is complete.
-

8.2.2 Device and connection status

G-240W-F ONTs support the retrieval of a variety of device and connection information, including:

- device information
- LAN status
- WAN status
- WAN status IPv6
- home networking information

- optics module status
- statistics
- voice information

Procedure 7 Device information retrieval

- 1 Select Status > Device Information from the top-level menu in the GPON Home Gateway window, as shown in Figure 29.

Figure 29 Device Information window

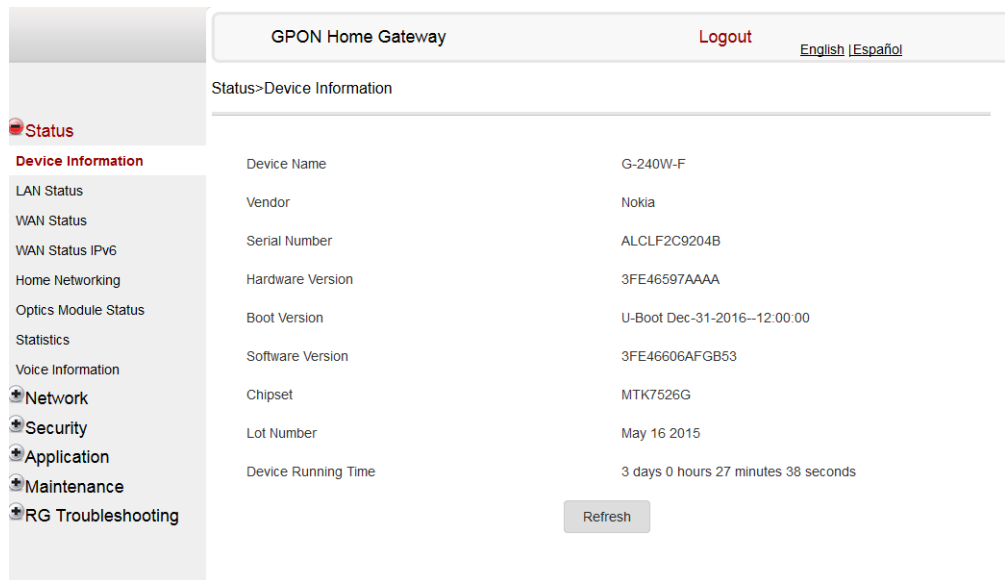

Table 16 describes the fields in the Device Information window.

Table 16 Device Information parameters

Field	Description
Device Name	Name on the ONT
Vendor	Name of the vendor
Serial Number	Serial number of the ONT
Hardware version	Hardware version of the ONT
Boot version	Boot version of the ONT
Software version	Software version of the ONT
Chipset	Chipset of the ONT

(1 of 2)

Field	Description
Lot Number	Production date of the ONT
Device Running Time	Amount of time the device has run since last reset in hours, minutes, and seconds

(2 of 2)

2 Click Refresh to update the displayed information.

3 STOP. This procedure is complete.

Procedure 8 LAN status retrieval

- 1 Select Status > LAN Status from the top-level menu in the GPON Home Gateway window, as shown in Figure 30.

Figure 30 LAN status window

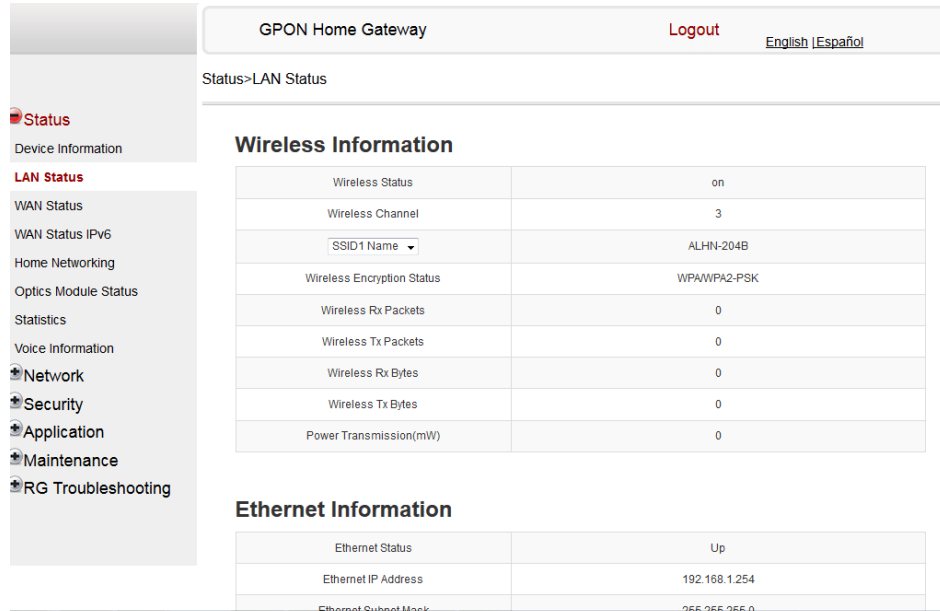

Table 17 describes the fields in the LAN status window.

Table 17 LAN status parameters

Field	Description
Wireless Information	
Wireless Status	Indicates whether the wireless is on or off
Wireless Channel	Wireless channel number
SSID Name	Name of each SSID
Wireless Encryption Status	Encryption type used on the wireless connection
Wireless Rx Packets	Number of packets received on the wireless connection
Wireless Tx Packets	Number of packets transmitted on the wireless connection
Wireless Rx Bytes	Number of bytes received on the wireless connection
Wireless Tx Bytes	Number of bytes transmitted on the wireless connection
Power Transmission (mW)	Power of the wireless transmission, in mW
Ethernet Information	
Ethernet Status	Indicates whether the Ethernet connection is on or off
Ethernet IP Address	IP address of the Ethernet connection
Ethernet Subnet Mask	Subnet Mask of the Ethernet connection
Ethernet MAC Address	MAC address of the Ethernet connection
Ethernet Rx Packets	Number of packets received on the Ethernet connection
Ethernet Tx Packets	Number of packets transmitted on the Ethernet connection
Ethernet Rx Bytes	Number of bytes received on the Ethernet connection
Ethernet Tx Bytes	Number of bytes transmitted on the Ethernet connection
Information (for each LAN line)	
Status	Status of the LAN line: up or down
Duplex Mode	Duplex mode: full duplex or half duplex
Max Bit Rate	Max bit rate: auto or number
Errors Received	Number of errors received
Errors Sent	Number of errors sent
Packets Received	Number of packets received
Packets Sent	Number of packets sent
Bytes Received	Number of bytes received
Bytes Sent	Number of bytes sent

2 Click Refresh to update the displayed information.

3 STOP. This procedure is complete.

Procedure 9 WAN status retrieval

1 Select Status > WAN Status from the top-level menu in the GPON Home Gateway window, as shown in Figure 31.

Figure 31 WAN status window

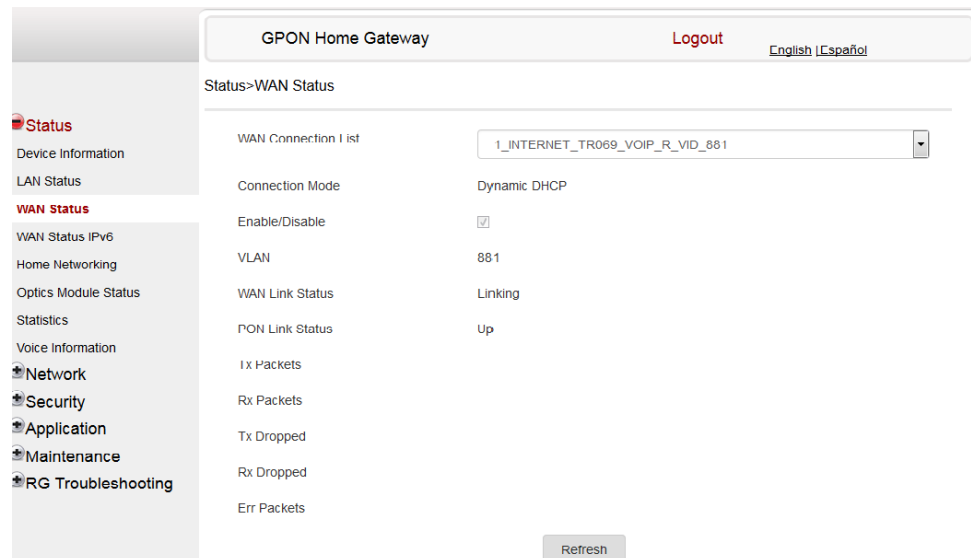

Table 18 describes the fields in the WAN status window.

Table 18 WAN status parameters

Field	Description
WAN connection list	Drop-down menu listing all WAN connections. The connection shown is the connection for which WAN status will be shown.
Connection Mode	Connection mode of the WAN connection
Enable/Disable	Select this checkbox to enable the WAN connection
VLAN	VLAN ID
WAN Link Status	Whether the WAN link is up or down

(1 of 2)

Field	Description
Pon Link Status	Whether the PON link is up or down
Tx Packets	Number of packets transmitted on the WAN connection
Rx Packets	Number of packets received on the WAN connection
Tx Dropped	Number of packets dropped on the transmit WAN connection
Rx Dropped	Number of packets dropped on the receive WAN connection
Err Packets	Number of errored packets on the WAN connection

(2 of 2)

2 Click Refresh to update the displayed information.

3 STOP. This procedure is complete.

Procedure 10 WAN status IPv6 retrieval

- 1 Select Status > WAN Status IPv6 from the top-level menu in the GPON Home Gateway window, as shown in Figure 32.

Figure 32 WAN status IPv6 window

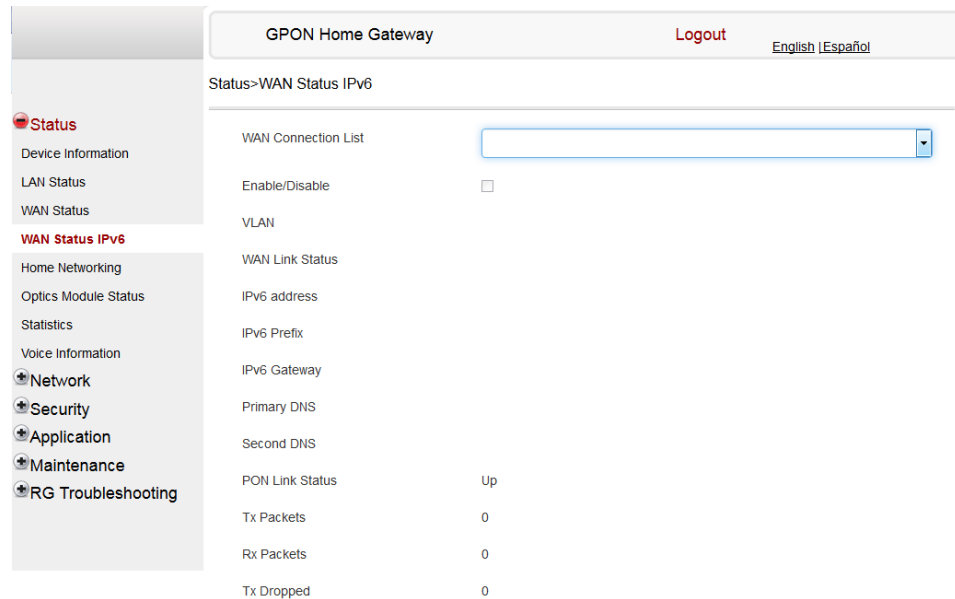

Table 19 describes the fields in the WAN status IPv6 window.

Table 19 WAN status IPv6 parameters

Field	Description
WAN connection list	Drop-down menu listing all WAN connections. The connection shown is the connection for which WAN status will be shown.
Enable/Disable	Select this checkbox to enable the WAN connection
VLAN	VLAN ID
WAN Link Status	Whether the WAN link is up or down
IPv6 Address	IPv6 Address that identifies the device and its location
IPv6 Prefix	IPv6 prefix
IPv6 Gateway	IPv6 gateway address
Primary DNS	Primary Domain Name Server
Second DNS	Secondary Domain Name Server
Pon Link Status	Whether the PON link is up or down
Tx Packets	Number of packets transmitted on the WAN connection
Rx Packets	Number of packets received on the WAN connection
Tx Dropped	Number of packets dropped on the transmit WAN connection
Rx Dropped	Number of packets dropped on the receive WAN connection
Err Packets	Number of errored packets on the WAN connection

2 Click Refresh to update the displayed information.

3 STOP. This procedure is complete.

Procedure 11 Home networking information retrieval

- 1 Select Status > Home Networking from the top-level menu in the GPON Home Gateway window, as shown in Figure 33.

Figure 33 Home networking information window

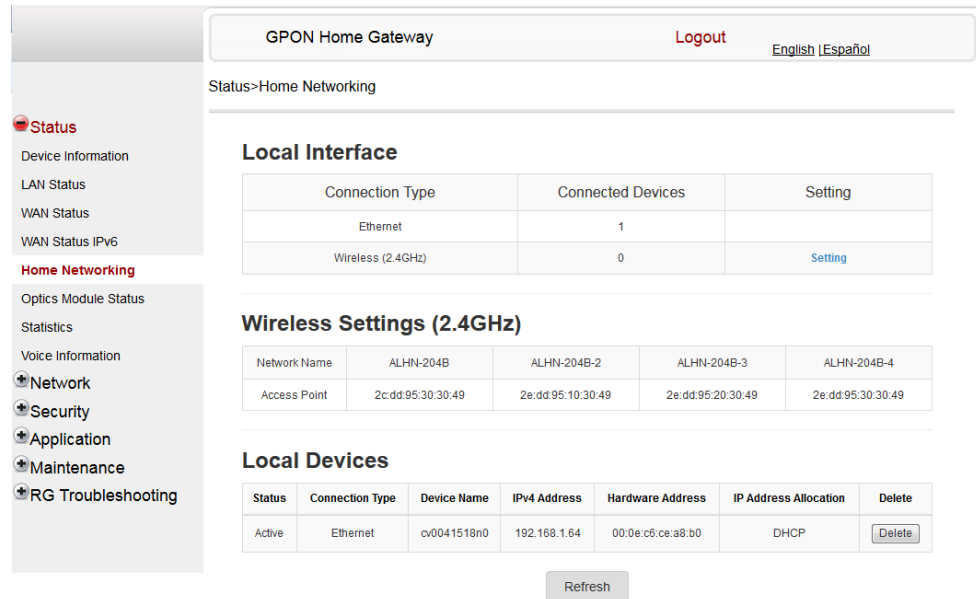

Table 20 describes the fields in the Home networking window.

Table 20 Home networking parameters

Field	Description
Local Interface	
Ethernet	Table displays the number of Ethernet connections and their settings
Wireless (2.4G)	Table displays the number of wireless connections and their settings
Wireless Settings (2.4G)	
Network Name	Name of the wireless network
Access Point	Hexadecimal address of the wireless access point
Local Devices	
Table entry	Each entry indicates the status, connection type, device name, IPv4 address, hardware address, and IP address allocation of each connected local device.

- 2 Click Delete to delete a particular local device connection.

3 Click Refresh to update the displayed information.

4 STOP. This procedure is complete.

Procedure 12 Optics module status retrieval

1 Select Status > Optics Module Status from the top-level menu in the GPON Home Gateway window, as shown in Figure 34.

Figure 34 Optics module status window

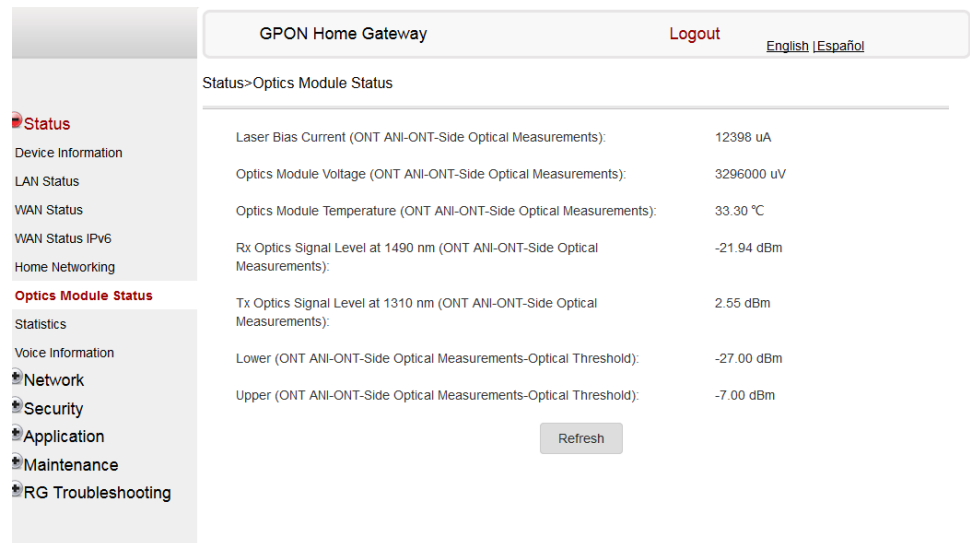

Table 21 describes the fields in the Optics module status window.

Table 21 Optics module status parameters

Field	Description
Laser Bias Current (ONT ANI-ONT-Side Optical Measurements)	Laser bias current, measured in uA
Optics Module Voltage (ONT ANI-ONT-Side Optical Measurements)	Optics module voltage, measured in V
Optics Module Temperature (ONT ANI-ONT-Side Optical Measurements)	Optics module temperature, measured in C
Rx Optics Signal Level at 1490 nm (ONT ANI-ONT-Side Optical Measurements)	Received optics signal level at 1490 nm, measured in dBm

(1 of 2)

Field	Description
Tx Optics Signal Level at 1310 nm (ONT ANI-ONT-Side Optical Measurements)	Transmitted optics signal level at 1310 nm, measured in dBm
Lower (ONT ANI-ONT-Side Optical Measurements-Optical Threshold)	Lower optical threshold, measured in dBm
Upper (ONT ANI-ONT-Side Optical Measurements-Optical Threshold)	Lower optical threshold, measured in dBm

(2 of 2)

- 2 Click Refresh to update the displayed information.
- 3 STOP. This procedure is complete.

Procedure 13 Statistics retrieval

- 1 Select Status > Statistics from the top-level menu in the GPON Home Gateway window.

Statistics are available for LAN ports and WAN ports.

Figure 35 shows the statistics for the LAN ports.

Figure 35 LAN ports Statistics window

COUNTERS	LAN1	LAN2	LAN3	LAN4
Bytes Sent	135031	969983	135127	135041
Bytes Received	0	886933	0	0
Packets Sent	1667	7944	1668	1667
Packets Received	0	10084	0	0
Errors Sent	0	0	0	0
Unicast Packets Sent	0	0	0	0
Unicast Packets Received	0	0	0	0
Discard Packets Sent	0	0	0	0
Discard Packets Received	0	1	0	0
Multicast Packets Sent	0	0	0	0
Multicast Packets Received	0	0	0	0
Broadcast Packets Sent	0	0	0	0
Broadcast Packets Received	0	0	0	0

If there are no WAN connections to display, the system displays a message to indicate that.

- 2 STOP. This procedure is complete.

Procedure 14 Voice information retrieval

- 1 Select Status > Voice Information from the top-level menu in the GPON Home Gateway window, as shown in Figure 36.

Figure 36 Voice Information window

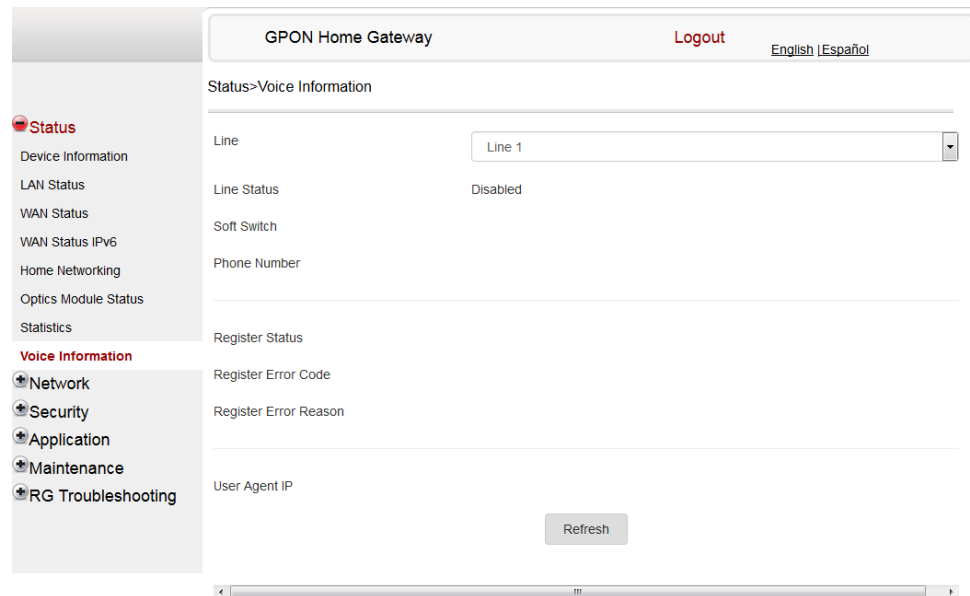

Table 22 describes the fields in the Voice Information window.

Table 22 Voice Information parameters

Field	Description
Line	Select the POTS line: 1 or 2
Line Status	Status of the selected POTS line: IDLE, Off Hook, or On Hook
Softswitch ⁽¹⁾	Proxy IP address; blank if the line is not registered
Phone number ⁽¹⁾	Phone number configured for the selected telephone line

(1 of 2)

Field	Description
Register Status	Registration status of the selected POTS port: registered or unregistered
Register Error Code	Error code for the unregistered POTS port
Register Error Reason	Error reason for the unregistered POTS port
User Agent IP	IP address of the user agent

(2 of 2)

Note

(¹) This field is only visible at the adminGPON level; it is not visible at the userAdmin level.

2 Click Refresh to update the displayed information.

3 STOP. This procedure is complete.

8.2.3 Network configuration

G-240W-F ONTs also support network configuration, including:

- LAN
- LAN IPv6
- WAN
- WAN DHCP
- wireless 2.4GHz
- wireless schedule
- IP routing
- DNS
- TR-069
- QoS

Procedure 15 LAN networking configuration

- 1 Select Network > LAN from the top-level menu in the GPON Home Gateway window, as shown in Figure 37.

Figure 37 LAN network window

Table 23 describes the fields in the LAN network window.

Table 23 LAN network parameters

Field	Description
Port Mode: All Port to L2 Mode	Select this checkbox to set all ports to Bridge mode
Port Mode: Port 1 - 4	Drop-down port mode for each port: Route mode or Bridge mode
IPv4 Address	IP Address of the ONT
Subnet Mask	Subnet mask of the ONT
DHCP enable	Select this checkbox to enable DHCP
DHCP Start IP Address	Starting DHCP IP address
DHCP End IP Address	Ending DHCP IP address
DHCP Lease Time	DHCP lease time (in min)
Primary DNS	Primary DNS address
Secondary DNS	Secondary DNS address

(1 of 2)

Field	Description
Static DHCP MAC Address	MAC address to associate to the LAN
Static DHCP IPv4 Address	IPv4 address to associate to the MAC address

(2 of 2)

-
- 2 Select the mode for each port.

 - 3 Click Save.

 - 4 Enter the DHCP configuration information.

 - 5 Click Save.

 - 6 Bind a MAC address to the LAN by entering the MAC and IP addresses and then clicking Add. Repeat for all MAC addresses to be bound.

 - 7 STOP. This procedure is complete.

Procedure 16 LAN IPv6 networking configuration

- 1 Select Network > LAN_IPv6 from the top-level menu in the GPON Home Gateway window, as shown in Figure 38.

Figure 38 LAN IPv6 network window

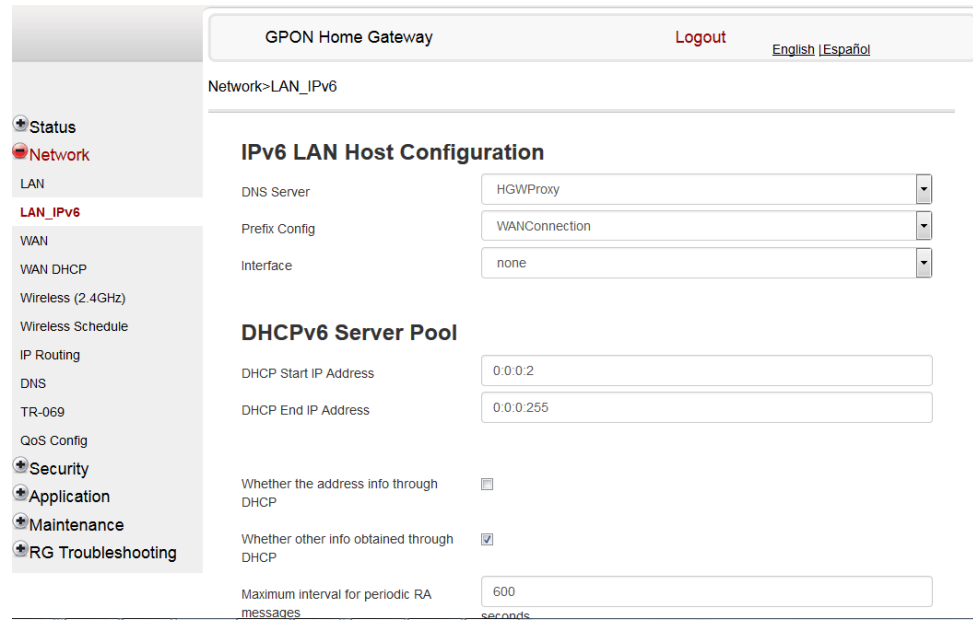

Table 24 describes the fields in the LAN IPv6 network window.

Table 24 LAN IPv6 network parameters

Field	Description
DNS Server	Choose a DNS server from the drop-down menu.
prefix config	Choose a prefix config option from the drop-down menu, either WANConnection (prefix will be obtained from the WAN) or Static (enables you to enter the prefix).
prefix	This field appears if you selected the "Static" option for the "prefix config" field. Type a connection.
Interface	This field appears if you selected the Wan Connection option for the "prefix config" field. Choose a WAN connection interface from the drop-down menu.
DHCP Start IP Address	Enter the starting DHCP IP address.
DHCP End IP Address	Enter the ending DHCP IP address.
Whether the address info through DHCP	Select this checkbox to enable address information retrieval through DHCP.

(1 of 2)

Field	Description
Whether other info obtained through DHCP	Select this checkbox to enable retrieval of other information through DHCP.
Maximum interval for periodic RA messages	Enter the maximum interval (in seconds) for periodic Router Advertisement messages. The interval range is from 4 to 1800.
Minimum interval for periodic RA messages	Enter the minimum interval (in seconds) for periodic Router Advertisement messages. The interval range is from 4 to 1800.

(2 of 2)

2 Choose a DNS server, prefix config, and interface.

3 Select or enter the DHCP configuration information.

4 Enter the maximum and minimum intervals for RA messages.

5 Click Save/Apply.

6 STOP. This procedure is complete.

Procedure 17 WAN networking configuration

- 1 Select Network > WAN from the top-level menu in the GPON Home Gateway window, as shown in Figure 39.

Figure 39 WAN network window

Table 25 describes the fields in the WAN network window.

Table 25 WAN network parameters

Field	Description
WAN Connection List	Choose a WAN connection from the drop-down menu to set the connection parameters
Connection Type	Select a connection type: IPoE or PPPoE
IP Mode	Choose an IP mode from the drop-down menu: IPv4 or IPv6
Enable/Disable	Select this checkbox to enable the WAN connection
NAT	Select this checkbox to enable NAT
Service	Select the checkboxes to enable service types for this connection
Enable VLAN	Select this checkbox to enable VLAN
VLAN ID	Enter the VLAN ID
VLAN PRI	Enter the VLAN PRI
WAN IP Mode	Choose an IP mode from the drop-down menu

(1 of 2)

Field	Description
Manual DNS	Enter a manual DNS

(2 of 2)

2 Configure a specific WAN connection.

3 Click Save.

4 STOP. This procedure is complete.

Procedure 18 WAN DHCP configuration

- 1 Select Network > WAN DHCP from the top-level menu in the GPON Home Gateway window, as shown in Figure 40.

Figure 40 WAN DHCP window

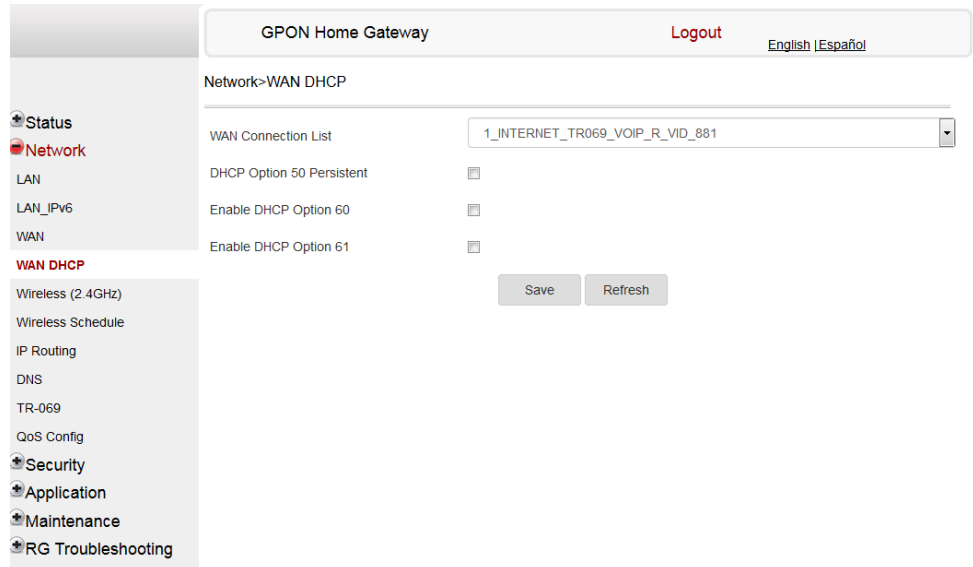

Table 26 describes the fields in the WAN DHCP window.

Table 26 WAN DHCP parameters

Field	Description
WAN Connection List	Choose a WAN connection from the drop-down menu
DHCP Option 50 persistent	Select this checkbox to enable DHCP Option 50 persistent
Enable DHCP Option 60	Select this checkbox to enable DHCP Option 60 (vendor class identifier)
Enable DHCP Option 61	Select this checkbox to enable DHCP Option 61 (client identifier)

- 2 Configure a WAN DHCP option.
- 3 Click Save.
- 4 STOP. This procedure is complete.

Procedure 19 Wireless 2.4GHz networking configuration

- 1 Select Network > Wireless 2.4GHz from the top-level menu in the GPON Home Gateway window, as shown in Figure 41.

Figure 41 Wireless 2.4GHz network window

The screenshot shows the configuration page for the GPON Home Gateway. The page title is "GPON Home Gateway" with a "Logout" link and language options "English | Español". The main heading is "Network>Wireless (2.4GHz)".

On the left is a navigation menu with the following items: Status, Network (highlighted), LAN, LAN_IPV6, WAN, WAN DHCP, Wireless (2.4GHz) (highlighted), Wireless Schedule, IP Routing, DNS, TR-069, QoS Config, Security, Application, Maintenance, and RG Troubleshooting.

The main configuration area includes the following settings:

- Enable:
- Mode: auto(b/g/n)
- Bandwidth: 20MHz
- Channel: Auto
- Transmitting Power: 100%
- WMM: Enable
- Total MAX Users: 32

Below these settings is the "SSID Configuration" section:

- SSID Select: SSID1
- SSID Name: ALHN-204B
- Enable SSID: Enable
- SSID Broadcast: Enable

Table 27 describes the fields in the Wireless 2.4GHz network window.

Table 27 WiFi 2.4G network parameters

Field	Description
Enable	Select this checkbox to enable WiFi
Mode	Choose a Wi-Fi mode from the drop-down menu: <ul style="list-style-type: none"> • auto (b/g/n) • b • g • n • b/g
Bandwidth	Choose from: <ul style="list-style-type: none"> • 20 MHz • 40 MHz • 20/40 MHz
Channel	Choose a channel from the drop-down menu or choose Auto to have the channel automatically assigned
Transmitting Power	Choose a percentage for the transmitting power from the drop-down menu: <ul style="list-style-type: none"> • Low (25%) • Medium (50%) • High (75%) • Maximum (100%)
WMM	Choose Enable or Disable from the drop-down menu to enable or disable WiFi multi-media
Total MAX Users	Enter the number of total MAX users
SSID Select	Choose the SSID from the drop-down menu
SSID Name	Enter the SSID name
Enable SSID	Enable or disable SSID from this drop-down menu
SSID Broadcast	Enable or disable SSID broadcast from this drop-down menu
MAX Users	Enter the number of MAX users
Encryption Mode	Choose an encryption mode from the drop-down menu: <ul style="list-style-type: none"> • OPEN • WEP • WPA/WPA2 Personal • WPA/WPA2 Enterprise ⁽¹⁾⁽²⁾
WPA Version	Choose a WPA version from the drop-down menu: <ul style="list-style-type: none"> • WPA1 • WPA2 • WPA1/WPA2
WPA Encryption Mode	Choose a WPA encryption mode from the drop-down menu: <ul style="list-style-type: none"> • TKIP • AES • TKIP/AES

(1 of 2)

Field	Description
WPA Key	Enter the WPA key
Enable WPS	Enable or disable WPS from this drop-down menu

(2 of 2)**Notes**

- (1) When Encryption Mode is set to "WPA/WPA2 Enterprise", the following options are no longer available: WPA version, WPA encryption mode, WPA key, Enable WPS, WPS mode.
- (2) When Encryption Mode is set to "WPA/WPA2 Enterprise", the following options become available: Primary RADIUS server, port and password; Secondary RADIUS server, port, and password; RADIUS accounting port.

2 Configure the WiFi connection.

3 If you have enabled and configured WPS, click WPS connect.

4 Click Save.

5 STOP. This procedure is complete.

Procedure 20 Wireless scheduling

- 1 Select Network > Wireless Schedule from the top-level menu in the GPON Gateway window, as shown in Figure 42.

Figure 42 Wireless Schedule window

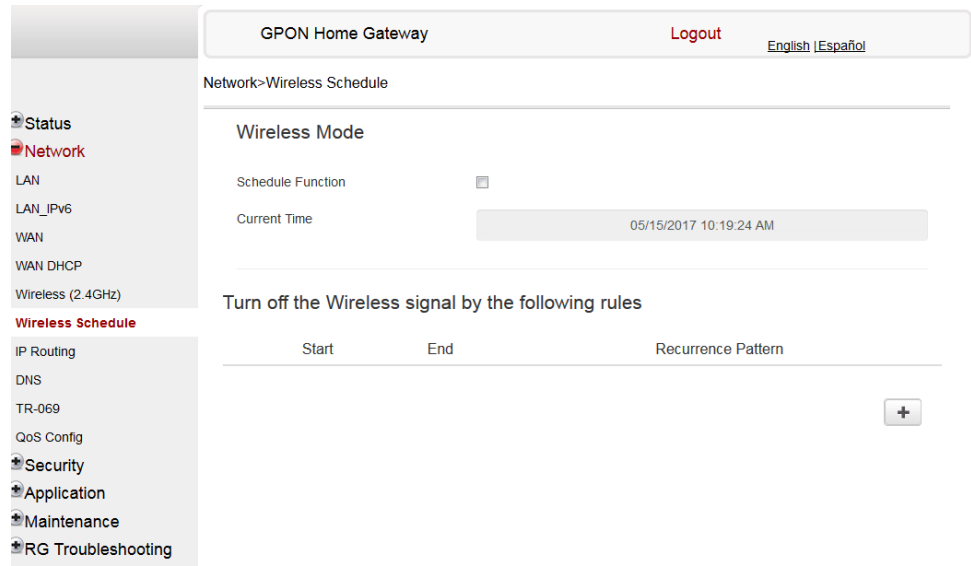

- 2 Select the Schedule Function checkbox to turn the wireless signal off for the configured period.
- 3 Click the plus sign (+) to add a scheduling rule.
A separate panel displays for configuring wireless schedule rules.
- 4 Enter a start time and end time for the period in which you want the wireless signal off.
- 5 Choose Everyday or Individual Days from the drop-down menu.
- 6 If you chose Individual Days, select the checkboxes for the desired days.
The Recurrence Pattern shows the rules created to date.
- 7 If desired, click the plus sign (+) to add more rules.

- 8 Click Save Changes.
- 9 STOP. This procedure is complete.

Procedure 21 IP Routing configuration

- 1 Select Network > IP Routing from the top-level menu in the GPON Home Gateway window, as shown in Figure 43.

Figure 43 IP Routing network window

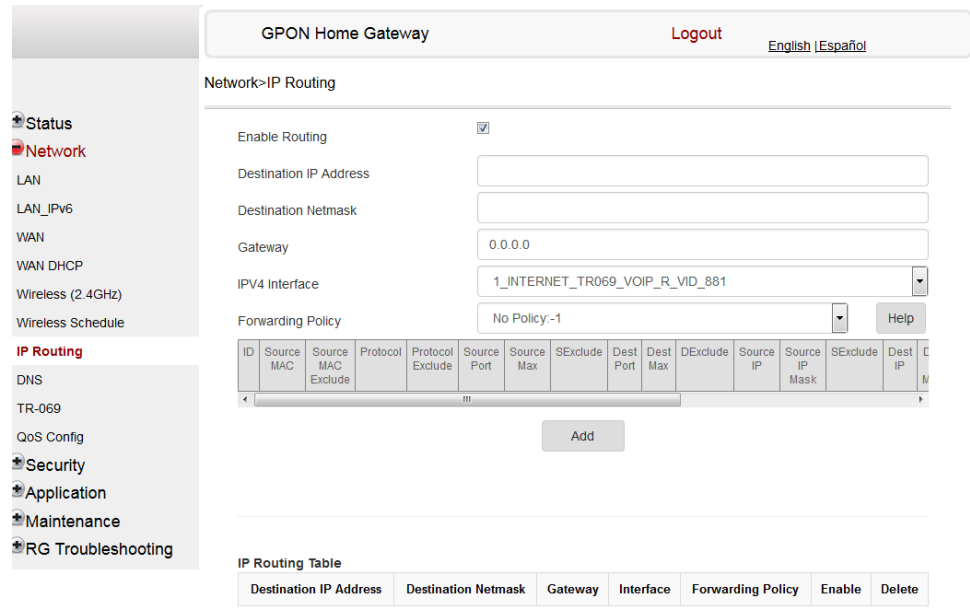

Table 28 describes the fields in the IP Routing network window.

Table 28 IP Routing network parameters

Field	Description
Enable Routing	Select this checkbox to enable routing
Destination IP Address	Enter the destination IP address
Destination Netmask	Enter the destination network mask
Gateway	Enter the gateway address

(1 of 2)

Field	Description
IPv4 Interface	Choose a WAN connection previously created in the WAN network window from the drop-down menu
Forwarding Policy	Choose a forwarding policy from the drop-down menu

(2 of 2)

- 2 Enter the routing information.
- 3 Click Add.
- 4 STOP. This procedure is complete.

Procedure 22 DNS configuration

- 1 Select Network > DNS from the top-level menu in the Home Gateway window, as shown in Figure 44.

Figure 44 DNS network window

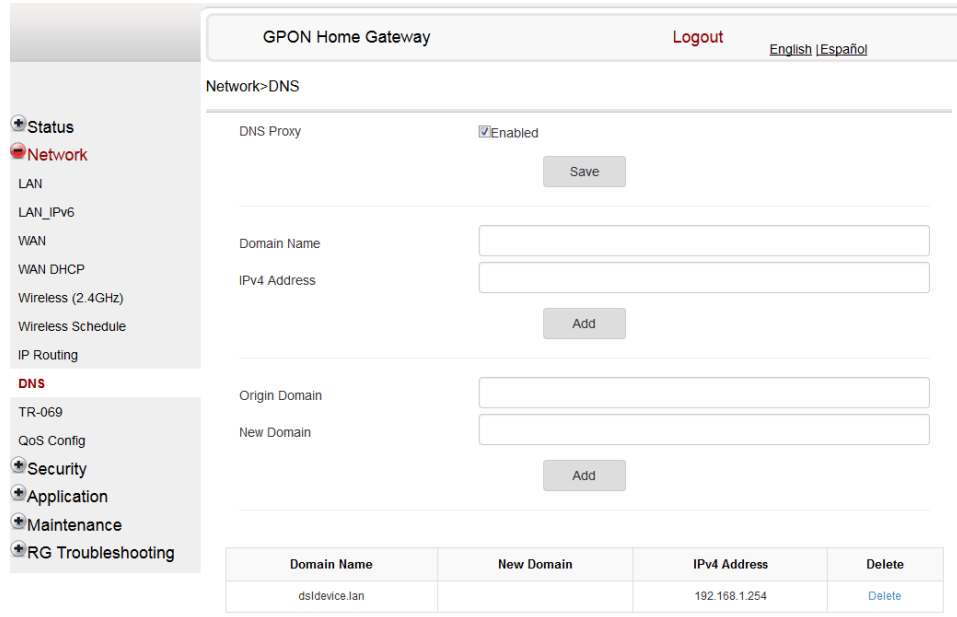

Table 29 describes the fields in the DNS network window.

Table 29 DNS network parameters

Field	Description
DNS Proxy Enabled	Select the Enabled checkbox to enable DNS proxy
Domain Name	Enter the domain name
IPv4 Address	Enter the IPv4 address
OriginalDomain	Enter the original domain name
New Domain	Enter the new domain name

2 Select the Enabled checkbox and click Save to enable DNS proxy.

3 Enter the domain name and IPv4 address and click Add.

4 If required, associate an original domain with a new domain, click Add.

5 STOP. This procedure is complete.

Procedure 23 TR-069 configuration

- 1 Select Network > TR-069 from the top-level menu in the GPON Home Gateway window, as shown in Figure 45.

Figure 45 TR-069 network window

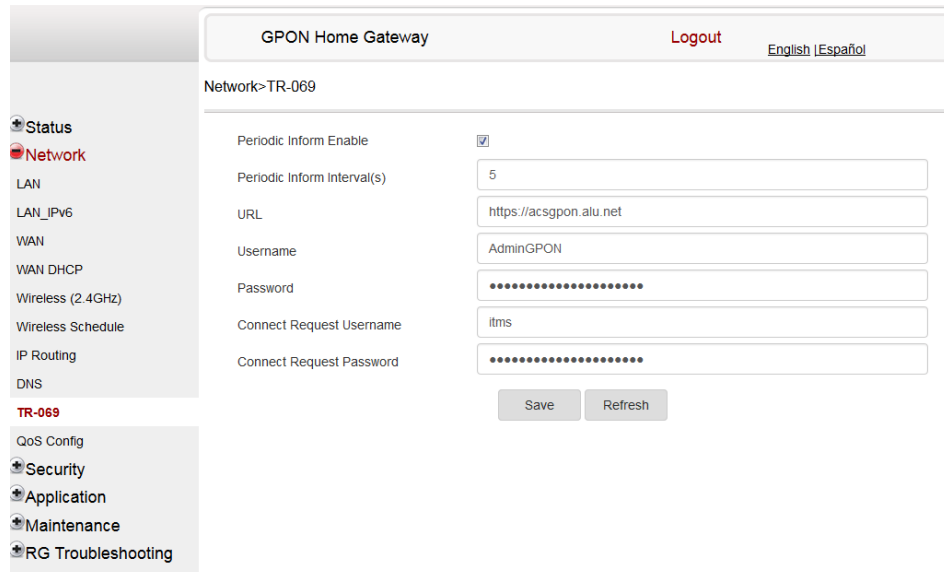

Table 30 describes the fields in the TR-069 network window.

Table 30 TR-069 network parameters

Field	Description
Periodic Inform Enable	Select this checkbox to enable periodic inform updates
Periodic Inform Interval(s)	Time between periodic inform updates, in seconds
URL	URL of the auto-configuration server
Username	Username used to log in to the ONT
Password	Password used to log in to the ONT
Connect Request Username	Username used to log in to the auto-configuration server
Connect Request Password	Password used to log in to the auto-configuration server

- 2 Configure TR-069 by entering the required information.

- 3 Click Save.
- 4 STOP. This procedure is complete.

Procedure 24 QoS configuration

- 1 Select Network > QoS Config from the top-level menu in the Home Gateway window.
Figure 46 shows the window for configuring QoS L2 (Layer 2 packet sizes).

Figure 46 QoS Config window (L2)

The screenshot shows the 'QoS Config' window for a GPON Home Gateway. The interface includes a sidebar menu with options like Status, Network, LAN, WAN, and Security. The main content area is titled 'Network>QoS Config' and contains the following fields:

- QoS Setting:** A table with columns for ID, Source MAC, Source MAC Exclude, Protocol, Protocol Exclude, Source Port, Source Max, SExclude, Dest Port, Dest Max, and DExclude.
- Type:** A dropdown menu set to 'L2 Criteria'.
- Classification Criteria:**
 - Source MAC: A text input field with an 'Exclude' checkbox.
 - Interface: A dropdown menu with 'select an option'.
- Classification Result:**
 - DSCP Remark: A text input field with '(Range: 0-63)' below it.
 - 802.1p Remark: A text input field with '(Range: 0-7)' below it.

Table 31 describes the fields in the QoS Config window.

Table 31 QoS Config parameters

Field	Description
Type	Choose a QoS service layer type from the drop-down menu L2 or L3.
Source MAC	Enter the source MAC. Select the Exclude checkbox to exclude the source MAC
Interface	Choose an interface from the drop-down menu

(1 of 2)

Field	Description
802.1p Mark	Enter the value for the 802.1p (range: 0-7)
DSCP Mark	Enter the value for the DSCP mark (range: 0-63)
Forwarding Policy	Enter the number for the forwarding policy (range: 1-7)
Additional fields for L3	
Protocol	Choose a protocol from the drop-down menu, or select the Exclude checkbox
Application	Choose an application from the drop-down menu
Source IP and Source IP Mask	Enter the values for the source IP and IP mask, or select the Exclude checkbox
Destination IP and Destination IP Mask	Enter the values for the destination IP and IP mask, or select the Exclude checkbox
Source Port and Source Port Max	Enter the values for the source port and port max (highest port number) or select the Exclude checkbox
Destination Port and Destination Port Max	Enter the values for the destination port and port max (highest port number), or select the Exclude checkbox

(2 of 2)

2 Choose a QoS type from the drop-down menu: L2 or L3.

3 Configure a QoS policy.

4 Click Add to add a QoS policy.

5 STOP. This procedure is complete.

8.2.4 Security configuration

G-240W-F ONT also supports security configuration, including:

- firewall
- MAC filter
- IP filter
- URL filter
- parental control
- DMZ and ALG
- access control

Procedure 25 Firewall configuration

- 1 Select Security > Firewall from the top-level menu in the GPON Home Gateway window, as shown in Figure 47.

Figure 47 Firewall window

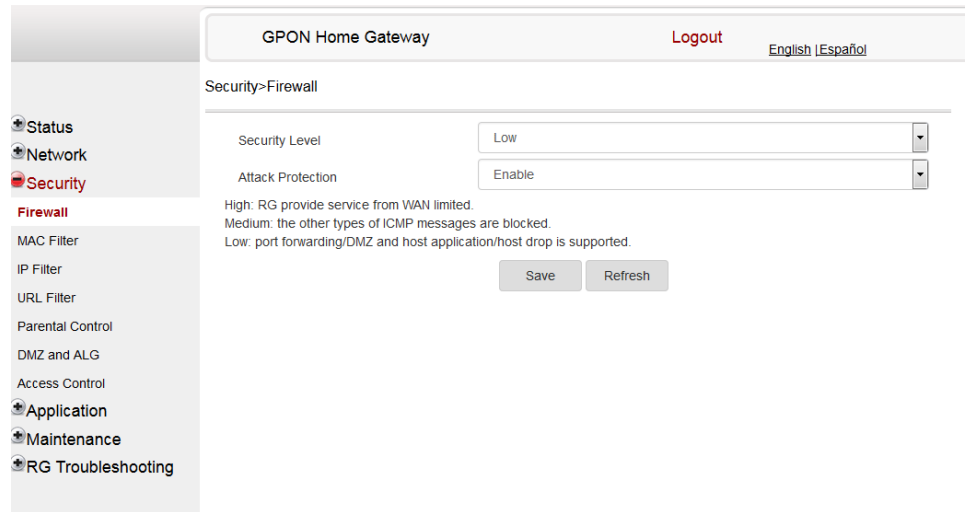

Firewall security applies only to services provided by the ONT. Internet access from the LAN side is not affected by this firewall.

Three security levels are available: Low, Medium, and High.

At the Low level, pre-routing is supported: port forwarding, DMZ, host application, and host drop. Also supported are application services: DDNS, DHCP, DNS, H248, IGMP, NTP client, SSH, Telnet, TFTP, TR-069, and VoIP.

At the Medium level, pre-routing is supported: port forwarding, DMZ, host application, and host drop. Also supported are application services: DDNS, DHCP, DNS, H248, IGMP, NTP client, TFTP, TR-069, and VoIP. The following types of ICMP messages are permitted: echo request and reply, destination unreachable, and TTL exceeded. Other types of ICMP messages are blocked. DNS proxy is supported from LAN to WAN but not from WAN to LAN.

At the High level, pre-routing and application services are not supported. UDP Port 8000 can be used to access the services, for example FTP can use 8021 and Telnet can use 8023. Regular UDP cannot be used. RG access is permitted via the LAN side but not via the WAN side.

Table 32 describes the fields in the firewall window.

Table 32 Firewall parameters

Field	Description
Security level	Choose the security level from the drop-down menu: low, medium, or high
Attack Protect (Protection against DoS or DDoS attacks)	Choose enable or disable attack protect from the drop-down menu The default is disable

- 2 Configure the firewall.
- 3 Click Save.
- 4 STOP. This procedure is complete.

Procedure 26 MAC filter configuration

- 1 Select Security > Mac Filter from the top-level menu in the GPON Home Gateway window, as shown in Figure 48.

Figure 48 MAC filter window

Table 33 describes the fields in the MAC filter window.

Table 33 MAC filter parameters

Field	Description
Enable MAC filter	Select this checkbox to enable the MAC filter
Mac Address	Select a MAC address from the drop-down menu or enter the address in the text field
Mac Filter Mode	Choose the MAC filter mode from this drop-down menu: Blocked or Allowed

- 2 Click Refresh to update the information.
- 3 Configure a MAC filter.
- 4 Click Add.
- 5 STOP. This procedure is complete.

Procedure 27 IP filter configuration

- 1 Select Security > IP filter from the top-level menu in the GPON Home Gateway window, as shown in Figure 49.

Figure 49 IP filter window

Table 34 describes the fields in the IP filter window.

Table 34 IP filter parameters

Field	Description
Enable IP Filter	Select this checkbox to enable an IP filter
Mode	Choose an IP filter mode from the drop-down menu: <ul style="list-style-type: none"> Drop for upstream Drop for downstream
Internal Client	Choose an internal client from the drop-down menu: <ul style="list-style-type: none"> Customer setting - uses the IP address input below IP - uses the connecting devices' IP to the ONT
Local IP Address	Local IP address
Source Subnet Mask	Source subnet mask
Remote IP Address	Remote IP address
Destination Subnet Mask	Destination subnet mask
Protocol	Choose an application protocol or all from the drop-down menu

2 Configure the IP filter.

3 Click Add.

4 STOP. This procedure is complete.

Procedure 28 URL filter configuration

- 1 Select Security > URL Filter from the top-level menu in the GPON Home Gateway window, as shown in Figure 50.

Figure 50 URL Filter window

Table 35 describes the fields in the URL Filter window.

Table 35 URL Filter parameters

Field	Description
Enable URL filter	Select the checkbox to enable the URL filter
URL filter type	Select the Block or Allow checkbox
URL Address	Type the URL address
Port Number	Type the port number; the default is 80

- 2 Configure the URL Filter.
- 3 Click Add Filter.
- 4 To configure additional filters, repeat steps 2 and 3.

You can configure up to 100 URL filters.

- 5 STOP. This procedure is complete.

Procedure 29 Parental control

- 1 Select Security > Parent Control from the top-level menu in the EPON Home Gateway window, as shown in Figure 51.

Figure 51 Parental Control window

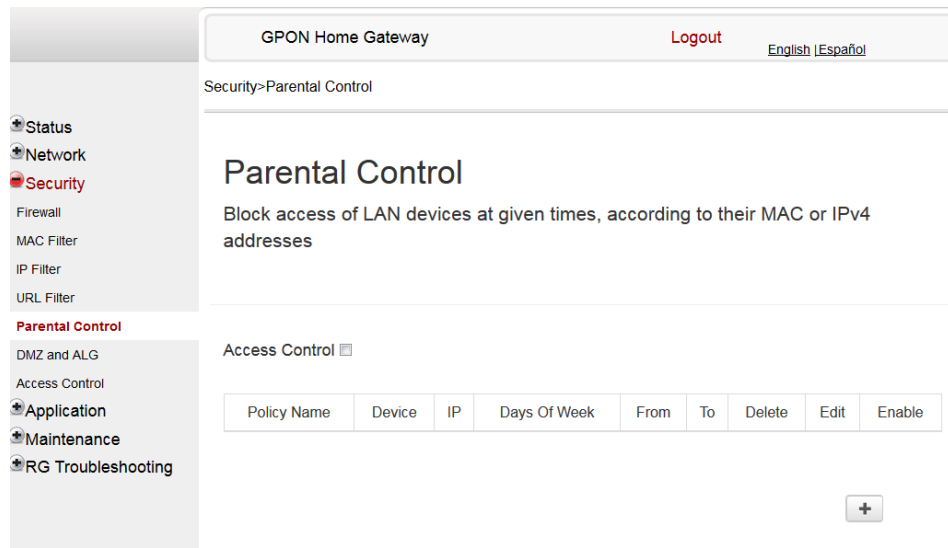

Table 36 describes the fields in the Parental Control window.

Table 36 Parental control parameters

Field	Description
Policy Name	Enter a name for the parental control policy or choose a policy from the list
Device	Enter the MAC address or choose a MAC address from the list
IP	Enter the IPv4 address for the device or choose an IPv4 address from the list
Days of the week	Choose Every Day, or Individual Days and select the checkboxes for the days of the week for which the policy applies
From/To	Enter the times for the policy to be in effect

2 Select the Access Control checkbox.

3 Click the plus sign (+) to add a policy.

A separate panel displays for configuring the policy name, IP address of the device, and dates and times for the policy.

4 Configure the parental control policy.

5 Click Enable to activate the policy.

6 STOP. This procedure is complete.

Procedure 30 DMZ and ALG configuration

1 Select Security > DMZ and ALG from the top-level menu in the GPON Home Gateway window, as shown in Figure 52.

Figure 52 DMZ and ALG window

Table 37 describes the fields in the DMZ and ALG window.

Table 37 DMZ and ALG parameters

Field	Description
ALG Config	Select the checkboxes to enable the protocols to be supported by the ALG: FTP, TFTP, SIP, H323, RTSP, L2TP, IPSEC, PPTP
DMZ Config	
WAN Connection List	Choose a WAN connection from the drop-down menu
Enable DMZ	Select this checkbox to enable DMZ on the chosen WAN connection
DMZ IP Address	Choose Customer Setting and enter the DMZ IP address or choose the IP address of a connected device from the drop-down menu

-
- 2** Configure ALG.
-
- 3** Click Save ALG.
-
- 4** Configure DMZ.
-
- 5** Click Save DMZ.
-
- 6** STOP. This procedure is complete.
-

Procedure 31 Access control configuration

This procedure describes how to configure the access control level (ACL).



Note 1 — ACL takes precedence over the firewall policy.

Note 2 — The trusted network object will be shared for all WAN connections; it is not applied individually to a WAN connection.

- 1 Select Security > Access Control from the top-level menu in the GPON Home Gateway window, as shown in Figure 53.

Figure 53 Access Control window

Table 38 describes the fields in the Access Control window.

Table 38 Access control parameters

Field	Description
WAN	Choose a connection from the drop-down menu
Trusted Network Enable	Click to enable or disable
ICMP, Telnet, SSH, HTTP, TR-069, HTTPS, SFTP	Select an access control level for each protocol: WAN side: Allow, Deny, or Trusted Network Only LAN side: Allow or Deny
Source IP Start	Enter a start IP address for the new subnet trusted network

(1 of 2)

Field	Description
Source IP End	Enter an end IP address for the new subnet trusted network

(2 of 2)

-
- 2 Select a WAN connection from the drop-down menu.

 - 3 Click to enable or disable Trusted Network.

 - 4 Select an access control level for each of the seven protocols for both the WAN and the LAN side.

 - 5 Click Save.

 - 6 Optionally, add one or more subnet trusted networks.

The maximum number of entries is 32.

You can also use the Source IP fields to delete a previously created entry for a subnet trusted network.

 - 7 STOP. This procedure is complete.

8.2.5 Application configuration

G-240W-F ONT also supports application configuration, including:

- port forwarding
- port triggering
- DDNS
- NTP
- USB storage
- UPnP and DLNA
- voice setting

Procedure 32 Port forwarding configuration

- 1 Select Application > Port forwarding from the top-level menu in the GPON Home Gateway window, as shown in Figure 54.

Figure 54 Port forwarding window

The screenshot shows the 'GPON Home Gateway' web interface. The top navigation bar includes 'Logout' and language options 'English | Español'. The left sidebar menu has 'Application' selected, with sub-items like 'Port Forwarding', 'Port Triggering', 'DDNS', 'NTP', 'USB', 'UPNP and DLNA', 'Voice Setting', 'Maintenance', and 'RG Troubleshooting'. The main content area is titled 'Application>Port Forwarding' and contains the following configuration fields:

- Application Name: Custom settings (dropdown)
- WAN Port: [] ~ []
- LAN Port: [] ~ []
- Internal Client: Custom settings (dropdown) []
- Protocol: TCP (dropdown)
- Enable Mapping:
- WAN Connection List: 1_INTERNET_TR069_VOIP_R_VID_881 (dropdown)

Below the fields is an 'Add' button. At the bottom, there is a table with the following columns: Application Name, WAN Connection, WAN Port, LAN Port, Device Name, Internal Client, Protocol, Status, and Delete.

Table 39 describes the fields in the port forwarding window.

Table 39 Port forwarding parameters

Field	Description
Application Name	Choose an application name from the drop-down menu
WAN Port	WAN port range
LAN Port	LAN port range
Internal Client	Choose a connected device from the drop-down menu and enter the associated IP address
Protocol	Choose the port forwarding protocol from the drop-down menu: <ul style="list-style-type: none"> • TCP • UDP • TCP/UDP
Enable Mapping	Select this checkbox to enable mapping
WAN Connection List	Choose a WAN connection from the drop-down menu Note: only active devices are shown on this menu

- 2 Configure port forwarding.

3 Click Add.

4 STOP. This procedure is complete.

Procedure 33 Port triggering

1 Select Application > Port Triggering from the top-level menu in the GPON Gateway window, as shown in Figure 55.

Figure 55 Port Triggering window

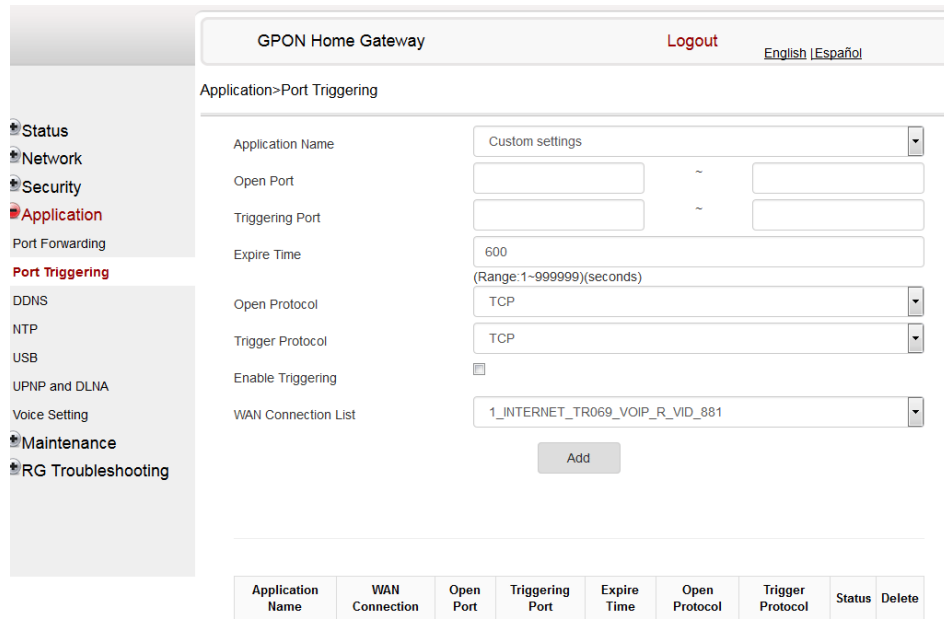

Table 40 describes the fields in the Port Triggering window.

Table 40 Port triggering parameters

Field	Description
Application Name	Choose an application name from the drop-down menu
Open Port	Enter the open port range
Triggering Port	Enter the triggering port range
Expire Time	Enter the expiration time in seconds

(1 of 2)

Field	Description
Open Protocol	Choose the open port protocol from the drop-down menu: <ul style="list-style-type: none"> • TCP • UDP • TCP/UDP
Trigger Protocol	Choose the triggering port protocol from the drop-down menu: <ul style="list-style-type: none"> • TCP • UDP • TCP/UDP
Enable Triggering	Select this checkbox to enable port triggering
WAN Connection List	Choose a WAN connection from the drop-down menu Note: only active devices are shown on this menu

(2 of 2)

- 2 Configure port triggering.
- 3 Click Add.
- 4 STOP. This procedure is complete.

Procedure 34 DDNS configuration

- 1 Select Application > DDNS from the top-level menu in the GPON Home Gateway window, as shown in Figure 56.

Figure 56 DDNS window

GPON Home Gateway Logout [English | Español](#)

Application>DDNS

WAN Connection List: 1_INTERNET_TR069_VOIP_R_VID_881

Enable DDNS:

ISP:

Domain Name:

Username:

Password:

Table 41 describes the fields in the DDNS window.

Table 41 DDNS parameters

Field	Description
WAN Connection List	Choose a WAN connection from the drop-down menu
Enable DDNS	Select this checkbox to enable DDNS on the chosen WAN connection
ISP	Choose an ISP from the drop-down menu.
Domain Name	Domain name
Username	Username
Password	Password

- 2 Configure the DDNS.
- 3 Click Save.
- 4 STOP. This procedure is complete.

Procedure 35 NTP configuration

- 1 Select Application > NTP from the top-level menu in the GPON Home Gateway window, as shown in Figure 57.

Figure 57 NTP window

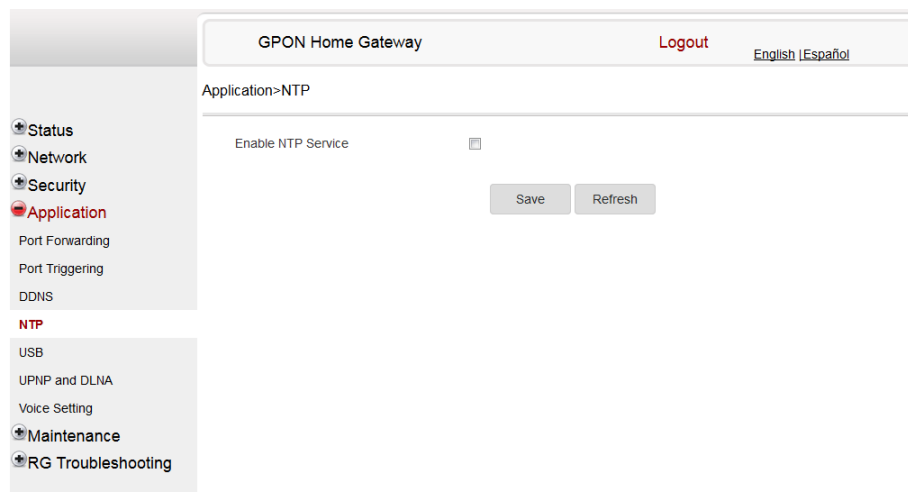

- 2 Select the Enable NTP Service checkbox to enable NTP service.
- 3 Click Save.
- 4 STOP. This procedure is complete.

Procedure 36 USB configuration

- 1 Select Application > USB from the top-level menu in the Ethernet Gateway window, as shown in Figure 58.

A USB printer that is connected to the ONT is available to all LAN devices.

Figure 58 USB window

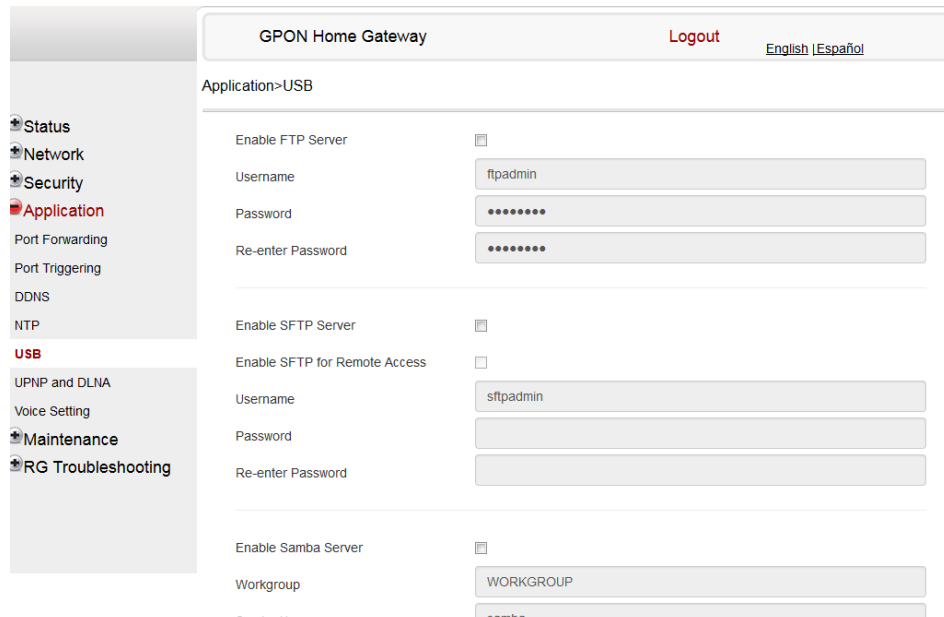

Table 42 describes the fields in the USB window.

Table 42 USB parameters

Field	Description
Enable FTP server	Select this checkbox to enable using an FTP server

(1 of 2)

Field	Description
Username	Username for FTP server
Password	Password for FTP server
Re-enter Password	Password for FTP server
Enable SFTP server	Select this checkbox to enable using an SFTP server
Enable SFTP for Remote Access	Select this checkbox to enable SFTP for remote access
Username	Username for SFTP server
Password	Password for SFTP server
Re-enter Password	Password for SFTP server
Enable Samba server	Select this checkbox to enable using a Samba server
Workgroup	Enter the name for the Samba work group
Samba Username	Username for Samba server
Samba Password	Password for Samba server
Re-enter Samba Password	Password for Samba server
Enable Printer Sharing	Select this checkbox to enable printer sharing Printer sharing is disabled by default
Connected USB devices	For each printer that is connected to the ONT, the following fields are displayed: <ul style="list-style-type: none"> • Host NUM: for example: Printer1, Printer2 • Dev NUM: name or identification for the printer • Format: printer format, for example: raw or LPR • Total space • Free space

(2 of 2)

2 Configure USB.

3 Click Save.

4 STOP. This procedure is complete.

Procedure 37 UPnP and DLNA configuration

- 1 Select Application > UPnP and DLNA from the top-level menu in the GPON Home Gateway window, as shown in Figure 59.

Figure 59 UPnP and DLNA window

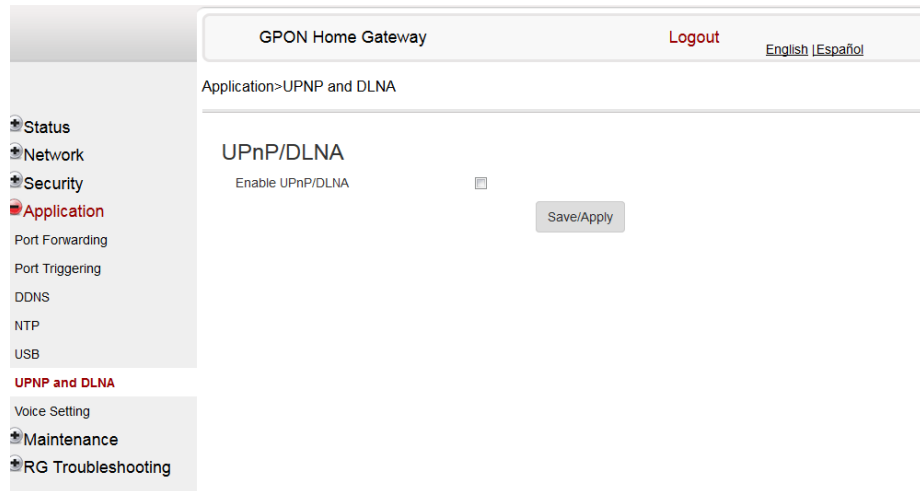

- 2 Select the Enable UPnP/DLNA checkbox to enable UPnP and DLNA.
 - 3 Click Save/Apply.
 - 4 STOP. This procedure is complete.
-

Procedure 38 Voice setting

- 1 Select Application > Voice Setting from the top-level menu in the EPON Home Gateway window, as shown in Figure 60.

Figure 60 Voice setting window

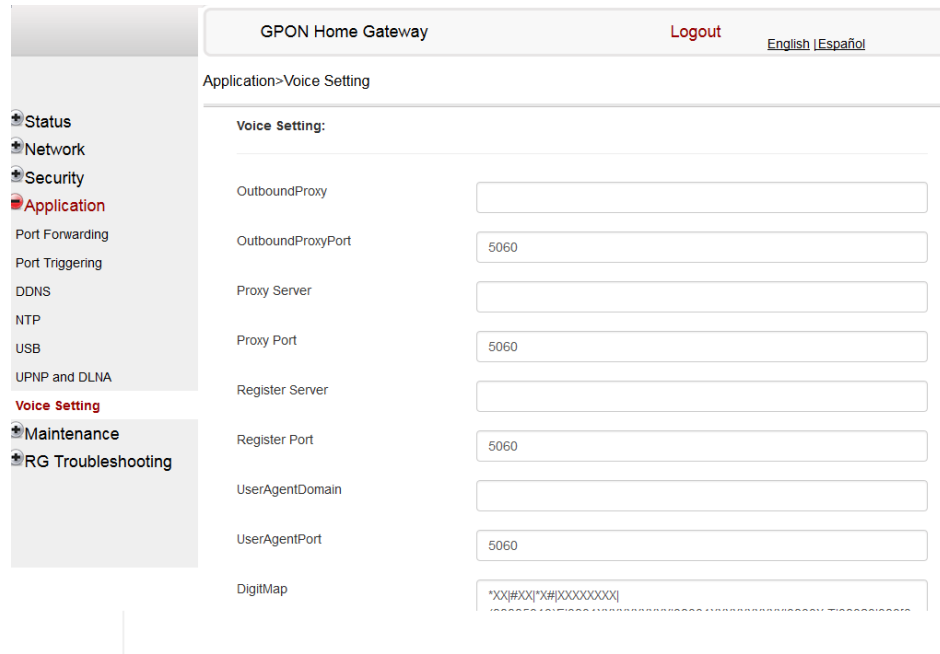

Table 43 describes the fields in the Voice Setting window.

Table 43 Voice setting parameters

Field	Description
Outbound Proxy	Enter the SIP outbound proxy
Outbound Proxy Port	Enter the outbound proxy port
Proxy Server	Enter the proxy server
Proxy Port	Enter the proxy port
Register Server	Enter the register server
Register Port	Enter the register port
User Agent Domain	Enter the user agent domain
User Agent Port	Enter the user agent port
DTMF Mode	Choose InBand, rfc2822, Info, or Auto from the drop-down menu
FaxT38	Choose False or True from the drop-down menu

(1 of 2)

Field	Description
Line	Choose a line from the drop-down menu
Enable	Choose Enabled or Disabled from the drop-down menu
Directory Number	Enter a directory number
AuthUserName	Enter an authorized user name
AuthPassword	Enter a password for the user
URL	Enter the URL

(2 of 2)

2 Configure voice setting.

3 Click Save.

4 STOP. This procedure is complete.

8.2.6 Maintenance

G-240W-F ONT also supports maintenance tasks, including:

- change password
- WAN speed test
- configure LOID
- configure SLID
- manage device
- backup and restore
- upgrade firmware
- reboot device
- restore factory defaults
- diagnose WAN connections
- log

Procedure 39 Password configuration

A password must adhere to the password rules, which are as follows:

- the password may consist of uppercase letters, lowercase letters, digital numbers, and the following special characters **! # + , - / @ _ : =]**
- the password length must be from 8 to 24 characters
- the first character must be a digital number or a letter

- the password must contain at least two types of characters: numbers, letters, or special characters
- the same character must not appear more than 8 times in a row

When the password meets the password rules, the application displays the message “Your password has been changed successfully”.

When the password does not meet the password rules, the application displays a message to indicate which password rule has not been followed, for example:

- the password is too short
- the password is too long
- the first character cannot be a special character
- there are not enough character classes

- 1 Select Maintenance > Password from the top-level menu in the GPON Home Gateway window, as shown in Figure 61.

Figure 61 Password window

The screenshot shows the 'GPON Home Gateway' web interface. At the top right, there are links for 'Logout' and language selection ('English | Español'). The breadcrumb trail indicates the current location is 'Maintenance > Password'. On the left, a navigation menu lists various system functions, with 'Maintenance' highlighted in red. The main area contains three text input fields: 'New Password', 'Re-enter Password', and 'Prompt Message'. Each field is filled with a series of asterisks to mask the input. Below these fields are two buttons: 'Save' and 'Refresh'.

Table 44 describes the fields in the password window.

Table 44 Password parameters

Field	Description
New Password	New password (must adhere to the password rules described above)
Re-enter password	Must match the new password entered above exactly
Prompt message	Password prompt message

- 2 Configure the new password.
- 3 Click Save.
- 4 STOP. This procedure is complete.

Procedure 40 WAN speed test

- 1 Select Maintenance > Speed Test from the top-level menu in the GPON Home Gateway window, as shown in Figure 62.

Figure 62 Speed Test window

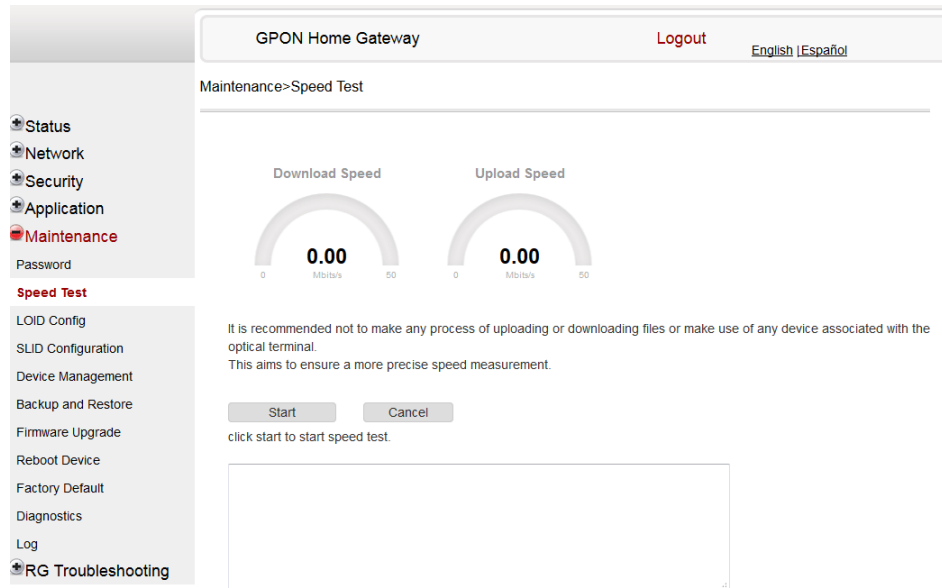

- 2 Click Start to start the speed test.
Enter the URL for the test server in the pop-up window.
- 3 STOP. This procedure is complete.

Procedure 41 LOID configuration

- 1 Select Maintenance > LOID Config from the top-level menu in the GPON Home Gateway window, as shown in Figure 63.

Figure 63 LOID Config window

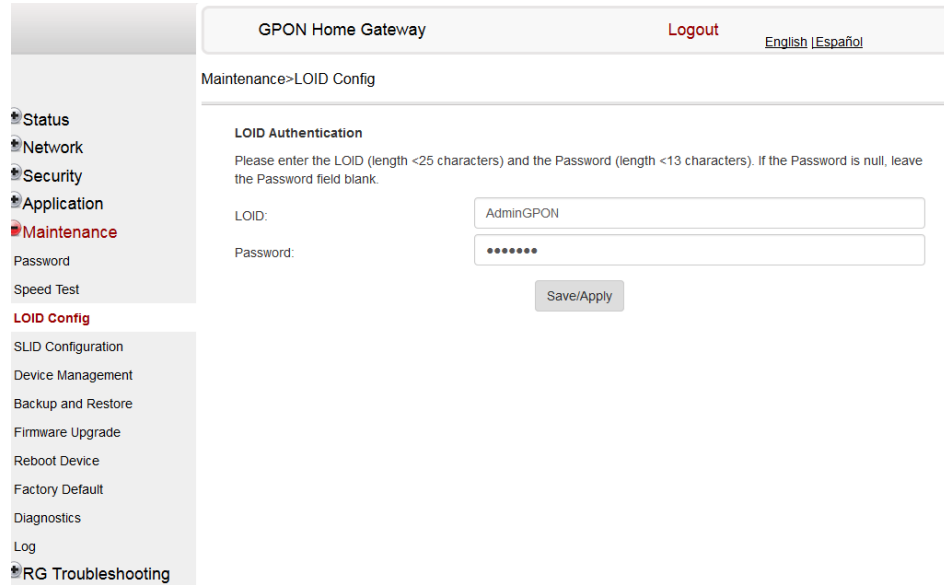

Table 45 describes the fields in the LOID configuration window.

Table 45 LOID configuration parameters

Field	Description
LOID	Type the LOID; the maximum number of characters is 24 If the password is null, this field may be left blank
Password	Type the password; the maximum number of characters is 12

- 2 Configure the LOID.
- 3 Click Save/Apply.
- 4 STOP. This procedure is complete.

Procedure 42 SLID configuration

- 1 Select Maintenance > SLID Configuration from the top-level menu in the GPON Home Gateway window, as shown in Figure 64.

Figure 64 SLID configuration window

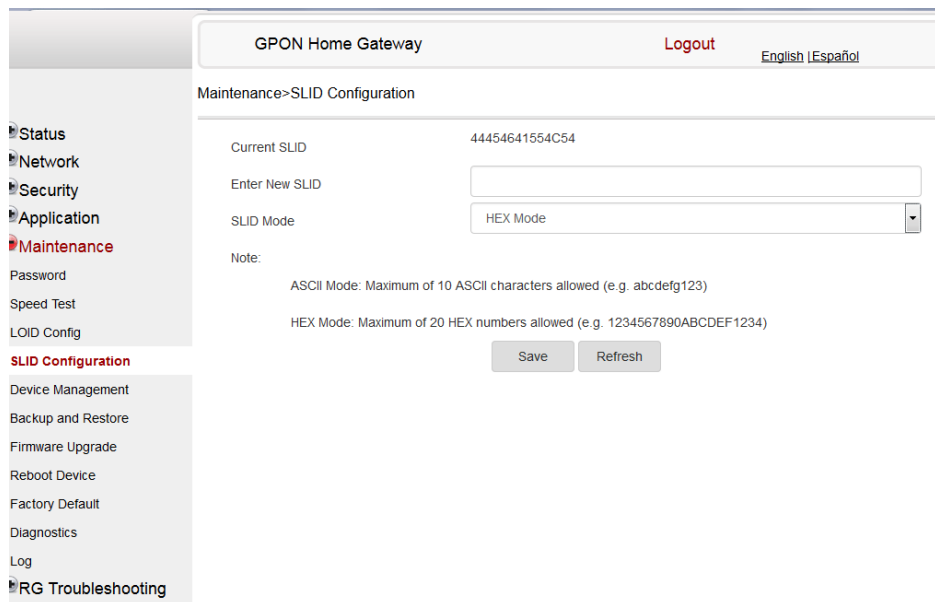

Table 46 describes the fields in the SLID configuration window.

Table 46 SLID configuration parameters

Field	Description
Current SLID	Displays current SLID
Input new SLID	Enter new SLID

(1 of 2)

Field	Description
SLID Mode	Choose a SLID mode from the drop-down menu: HEX or ASCII In ASCII mode, the maximum number of characters is 10, for example: abcdefg123. In HEX mode, the maximum number of characters is 20, for example: 1234567890ABCDEF1234

(2 of 2)

- 2 Configure the new SLID.
- 3 Click Save.
- 4 STOP. This procedure is complete.

Procedure 43 Device management

- 1 Select Maintenance > Device Management from the top-level menu in the GPON Home Gateway window, as shown in Figure 65.

Figure 65 Device management window

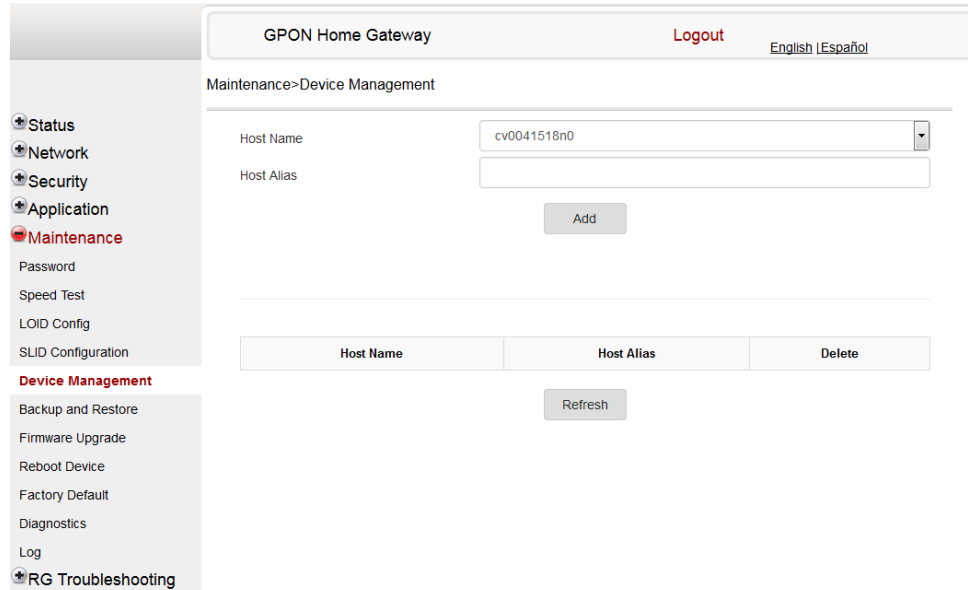

Table 47 describes the fields in the Device management window.

Table 47 Device management parameters

Field	Description
Host Name	Choose a host from the drop-down menu
Host Alias	Enter an alias for the chosen host

2 Configure an alias for a specific host.

3 Click Add.

4 STOP. This procedure is complete.

Procedure 44 Backup and restore

1 Select Maintenance > Backup and Restore from the top-level menu in the GPON Home Gateway window, as shown in Figure 66.

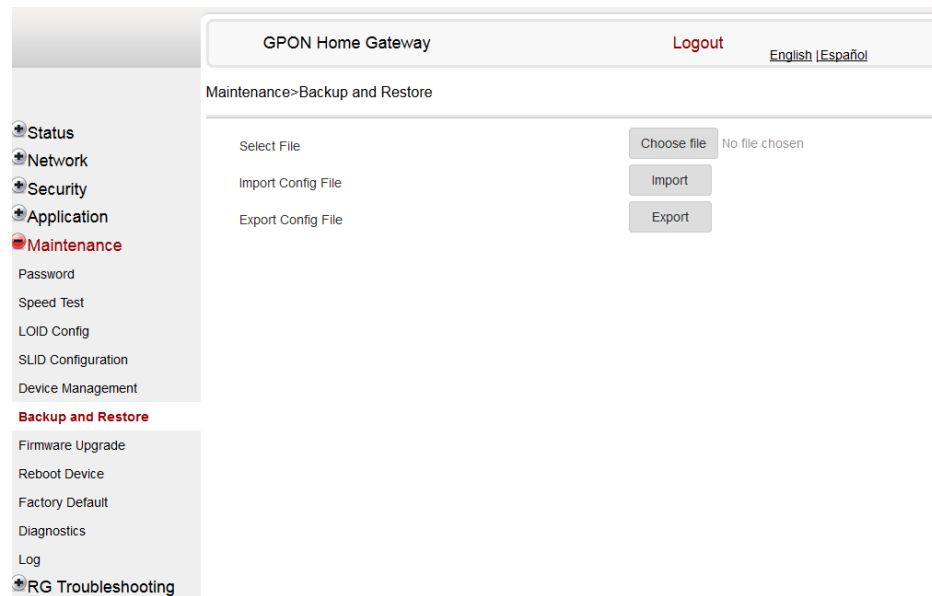
Figure 66 Backup and Restore window

2 Click Choose File and choose the backup file.

-
- 3 Click Import Config File to restore the ONT to the saved backup or click Export Config File to export the current ONT configuration to the backup file.
-
- 4 STOP. This procedure is complete.
-

Procedure 45 Upgrade firmware

-
- 1 Select Maintenance> Firmware Upgrade from the top-level menu in the GPON Home Gateway window, as shown in Figure 67.

Figure 67 Firmware upgrade window

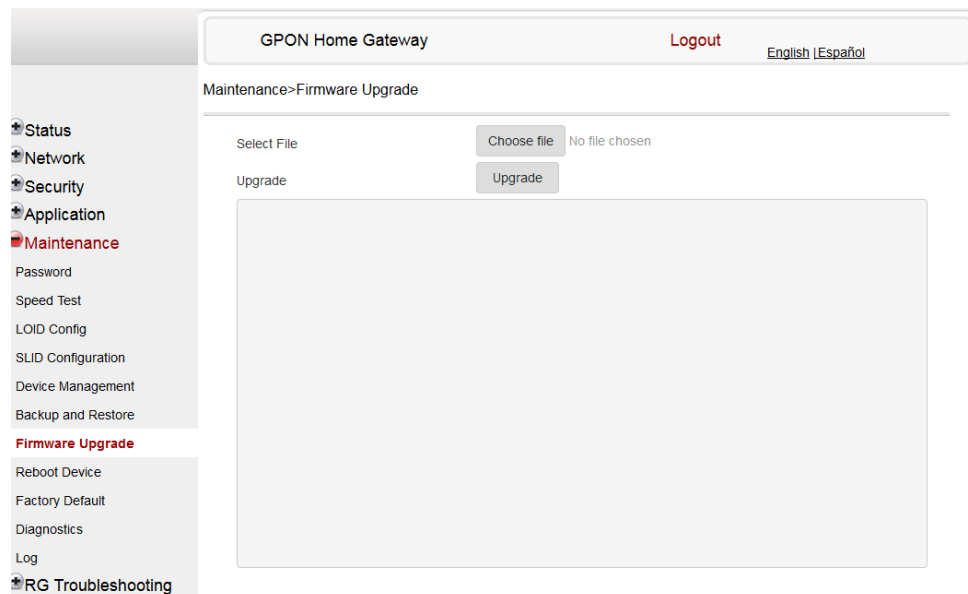

-
- 2 Click Choose File and choose the firmware file.
-
- 3 Click Upgrade to upgrade the firmware.
-
- 4 STOP. This procedure is complete.
-

Procedure 46 Reboot ONT

- 1 Select Maintenance > Reboot Device from the top-level menu in the GPON Home Gateway window, as shown in Figure 68.

Figure 68 Reboot window

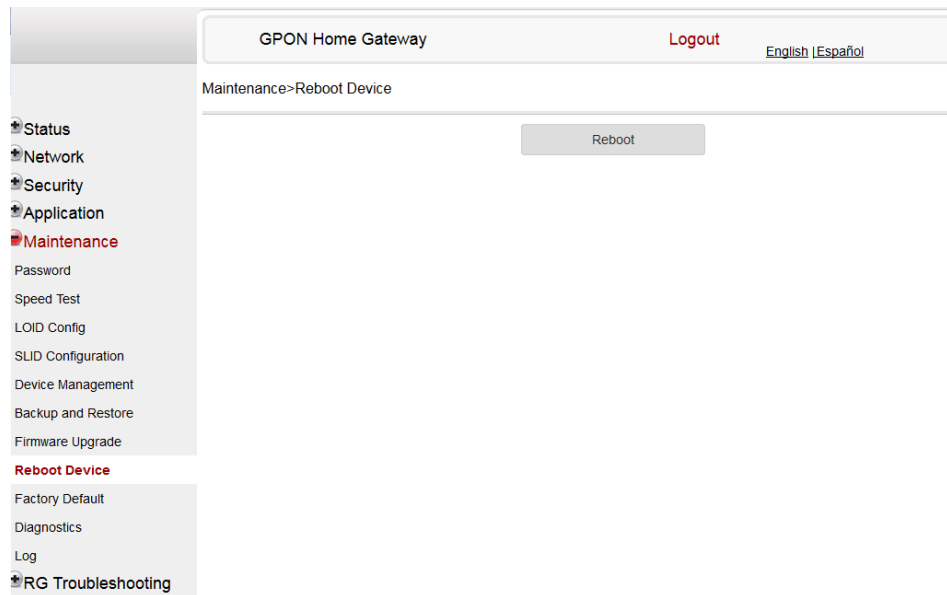

- 2 Click Reboot to reboot the ONT.
 - 3 STOP. This procedure is complete.
-

Procedure 47 Restore factory defaults

- 1 Select Maintenance > Factory Default from the top-level menu in the GPON Home Gateway window, as shown in Figure 69.

Figure 69 Factory default window

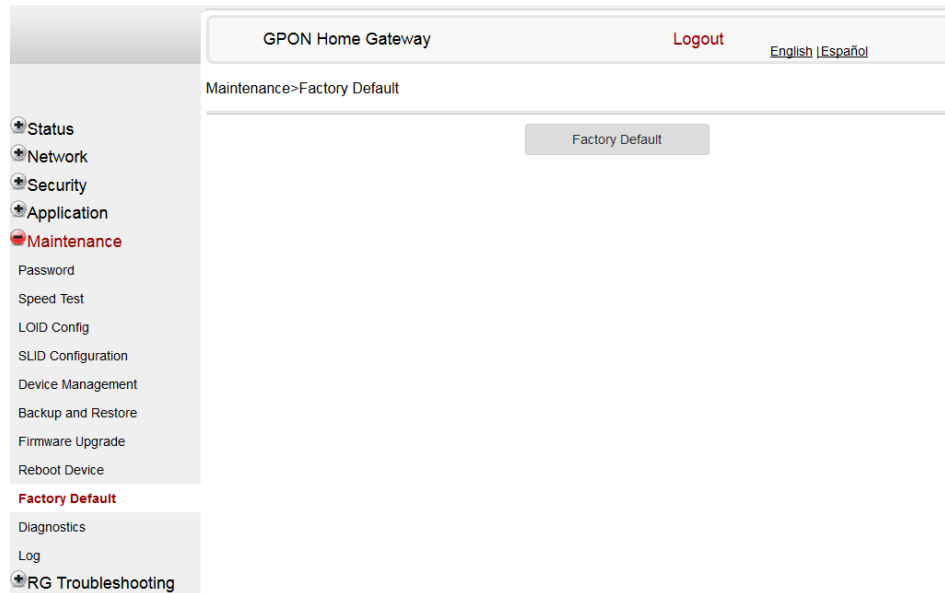

- 2 Click Factory Default to reset the ONT to its factory default settings.
 - 3 STOP. This procedure is complete.
-

Procedure 48 Diagnose WAN connections

- 1 Select Maintenance > Diagnostics from the top-level menu in the GPON Home Gateway window, as shown in Figure 70.

Figure 70 Diagnostics window

- 2 Choose a WAN connection to diagnose from the drop-down menu.
- 3 Enter the IP address or domain name.
- 4 Select the test type: ping, traceroute, or both.
- 5 Enter the number of ping attempts to perform (1 - 1000); the default is 4.
- 6 Enter a ping packet length (64-1500); the default is 64.
- 7 Enter the maximum number of trace hops (1-255); the default is 30.
- 8 Click Start Test.

The results will be displayed in the bottom panel of the window.

9 Click Cancel to cancel the test.

10 STOP. This procedure is complete.

Procedure 49 View log files

1 Select Maintenance > Log from the top-level menu in the GPON Home Gateway window, as shown in Figure 71.

Figure 71 Log window

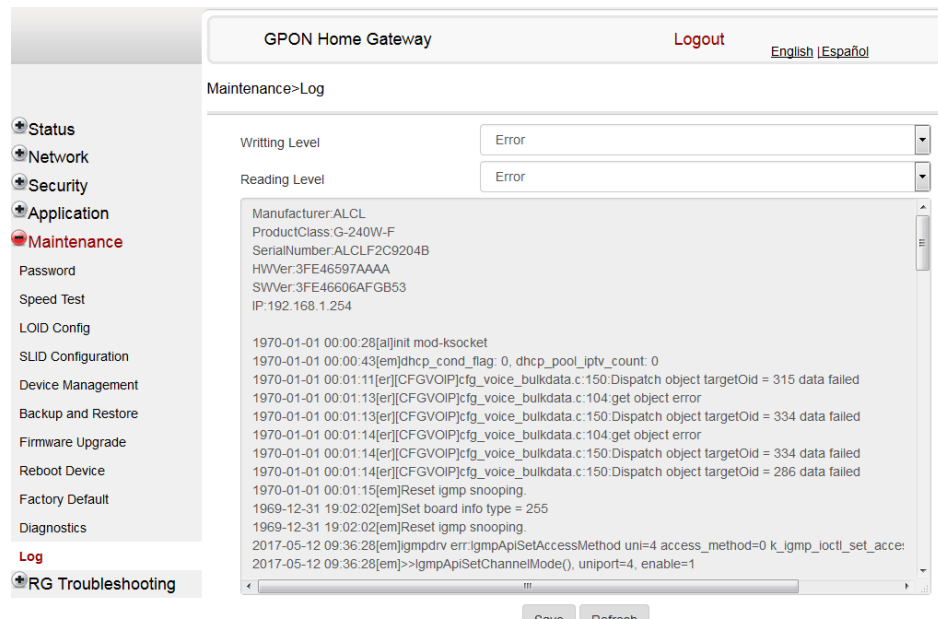

2 Choose a write level from the drop-down menu to determine which types of events are recorded in the log file:

- Emergency
- Alert
- Critical
- Error
- Warning
- Notice
- Informational
- Debug

-
- 3 Choose a reading level from the drop-down menu to determine which types of events to display from the log file:
 - Emergency
 - Alert
 - Critical
 - Error
 - Warning
 - Notice
 - Informational
 - Debug
 - 4 The log file is displayed in the bottom panel of the window.
 - 5 STOP. This procedure is complete.
-

8.2.7 RG troubleshooting counters

The Troubleshooting Counters feature enables service providers and end users to monitor the performance of their broadband connection.

Tests are run to retrieve upstream and downstream throughput, latency, and DNS response time. The Troubleshooting Counters window also displays upstream and downstream packet loss and Internet status.

Procedure 50 Retrieve Residential Gateway (RG) troubleshooting counters

- 1 Select RG Troubleshooting Counters from the left menu in the GPON Home Gateway window.

The RG Troubleshooting Counters window appears; see Figure [72](#).

Figure 72 RG Troubleshooting Counters window

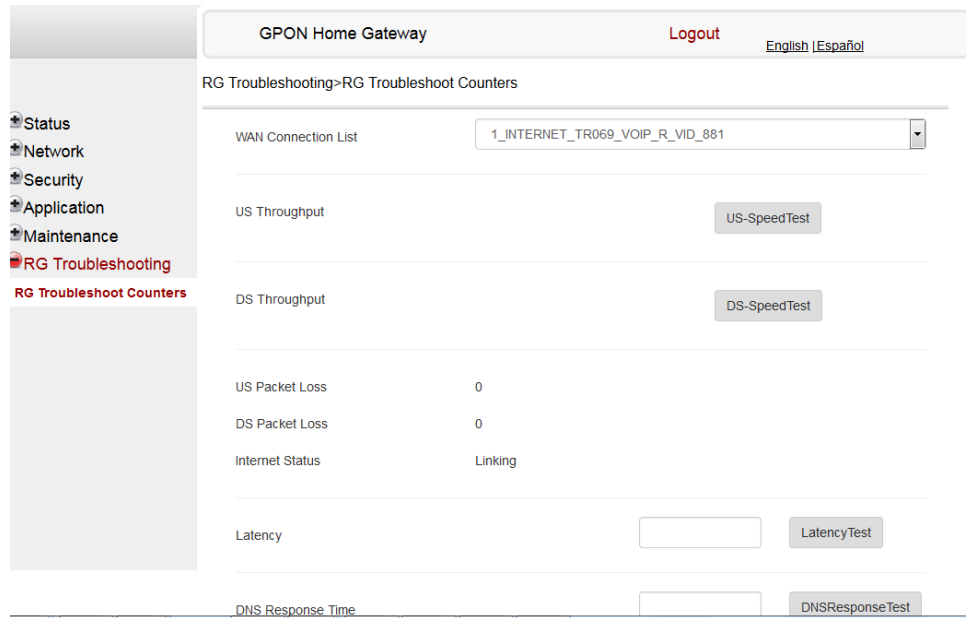

Table 48 describes the fields in the RG Troubleshooting Counters window.

Table 48 RG Troubleshooting Counters parameters

Field	Description
WAN Connection List	Select a WAN connection from the list
US Throughput	Click US Speed Test to specify the time for the upstream test The default is weekly, performed at idle to a public server
DS Throughput	Click DS Speed Test to specify the time for the downstream test The default is weekly, performed at idle to a public server
US Packet Loss	The number of upstream packages lost
DS Packet Loss	The number of downstream packages lost
Internet Status	Whether the broadband connections is active (UP) or not (DOWN)
Latency	Click Latency Test to specify the time for the test The default is weekly, performed at idle to a public server
DNS Response Time	Click DNS Response Test to specify the time for the test The default is weekly, performed at idle to a public server
Port Mirror	Choose the source and destination ports, the direction (up or down), and the status (enable or disable) from the drop-down menu, and click Save

-
- 2 Configure the test times if desired.
 - 3 Click Refresh to update the data.
 - 4 STOP. This procedure is complete.
-

8.3 SFU mode GUI configuration

Use the procedures below to use the web-based GUI for the G-240W-F in SFU mode.

SFU customer premise devices are designed for single indoor residential applications. These ONTs address the demand for bandwidth intensive services, such as high definition television (HDTV), video-on-demand (VOD) and online games. The ONT can be configured to seamlessly deliver voice-over-IP and high speed Internet access via a single fiber optic connection to the home.

8.3.1 Login

Use the procedure below to login to the web-based GUI for the G-240W-F.

Procedure 51 Login to web-based GUI

-
- 1 Open a web browser and enter the IP address of the ONT in the address bar.

The login window appears.

The default gateway IP address is `http://192.168.1.254`. You can connect to this IP address using your web browser after connecting your PC to one of Ethernet ports of the ONT. The static IP address of your PC must be in the same subnet as the ONT.

-
- 2 Enter your username and password in the Log in window, as shown in Figure 73.

The default username is AdminGPON. The default password is ALC_FGU.

Figure 73 Web login window

The screenshot shows a web login window titled "SFU Login". It features a teal header and footer. The main content area is white and contains two input fields. The "Username" field is labeled "Username" and contains the text "adminadmin". The "Password" field is labeled "Password" and contains masked characters represented by black dots. Below the input fields, there are two buttons: "Login" and "Reset".



Caution — Pressing the Reset button for less than 10 seconds reboots the ONT; pressing the Reset button for 10 seconds resets the ONT to the factory defaults, except for the LOID and SLID.



Note — If you forget the current username and password, press the reset button for 10 s and the default values for the username and password will be recovered at startup.

3 Click Login.

4 STOP. This procedure is complete.

8.3.2 Device and connection status

G-240W-F ONTs support the retrieval of a variety of device information, as well as the optics module status.

Procedure 52 Device information retrieval

- 1 Select Status > Device Information from the top-level menu in the SFU GPON Home Gateway window, as shown in Figure 74.

Figure 74 Device Information window

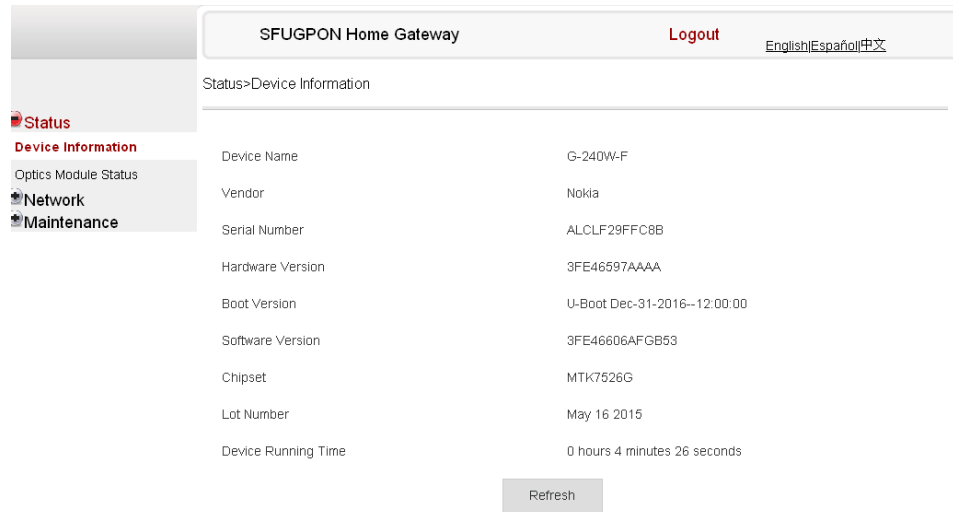

Table 49 describes the fields in the Device Information window.

Table 49 Device Information parameters

Field	Description
Device Name	Name on the ONT
Vendor	Name of the vendor
Serial Number	Serial number of the ONT
Hardware version	Hardware version of the ONT
Boot version	Boot version of the ONT
Software version	Software version of the ONT
Chipset	Chipset of the ONT
Lot Number	The manufacturing date of the ONT
Device Running Time	Amount of time the device has run since last reset in hours, minutes, and seconds

- 2 Click Refresh to update the displayed information.
- 3 STOP. This procedure is complete.

Procedure 53 Optics module status retrieval

- 1 Select Status > Optics Module Status from the top-level menu in the SFU GPON Home Gateway window, as shown in Figure 75.

Figure 75 Optics module status window

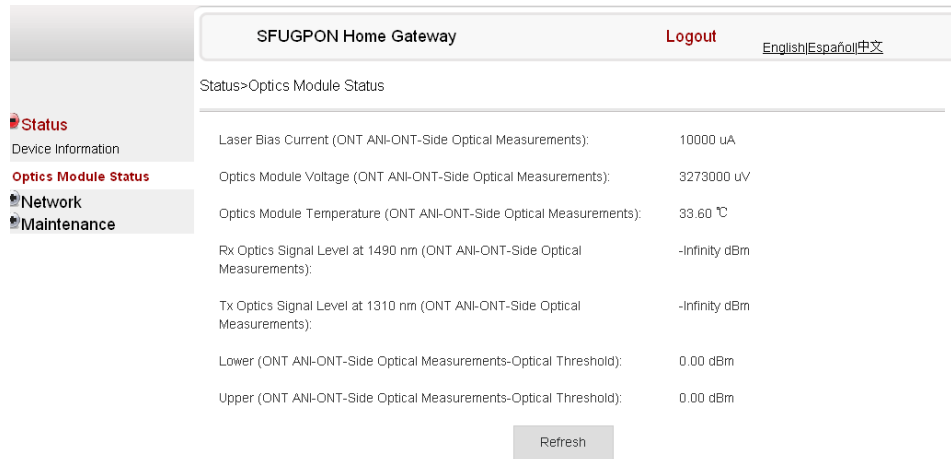

Table 50 describes the fields in the Optics module status window.

Table 50 Optics module status parameters

Field	Description
Laser Bias Current (ONT ANI-ONT-Side Optical Measurements)	Laser bias current, measured in uA
Optics Module Voltage (ONT ANI-ONT-Side Optical Measurements)	Optics module voltage, measured in V
Optics Module Temperature (ONT ANI-ONT-Side Optical Measurements)	Optics module temperature, measured in C
Rx Optics Signal Level at 1490 nm (ONT ANI-ONT-Side Optical Measurements)	Received optics signal level at 1490 nm, measured in dBm
Tx Optics Signal Level at 1310 nm (ONT ANI-ONT-Side Optical Measurements)	Transmitted optics signal level at 1310 nm, measured in dBm

(1 of 2)

Field	Description
Lower (ONT ANI-ONT-Side Optical Measurements-Optical Threshold)	Lower optical threshold, measured in dBm
Upper (ONT ANI-ONT-Side Optical Measurements-Optical Threshold)	Lower optical threshold, measured in dBm

(2 of 2)

- 2 Click Refresh to update the displayed information.
- 3 STOP. This procedure is complete.

8.3.3 Network configuration

G-240W-F ONTs also support wireless scheduling.

Procedure 54 Wireless scheduling

- 1 Select Network > Wireless Schedule from the top-level menu in the SFU GPON Gateway window, as shown in Figure 76.

Figure 76 Wireless Schedule window

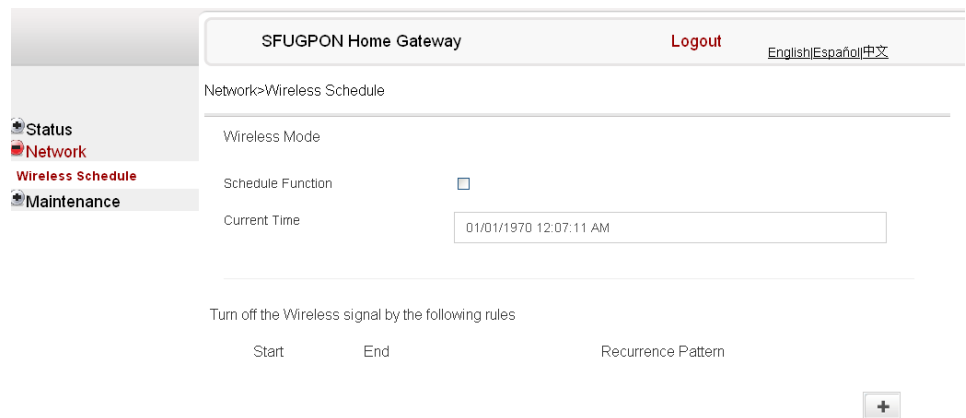

- 2 Select the Schedule Function checkbox to turn the wireless signal off for the configured period.
- 3 Click the plus sign (+) to add a scheduling rule.

A separate panel displays for configuring wireless schedule rules.

-
- 4 Enter a start time and end time for the period in which you want the wireless signal off.

 - 5 Choose Everyday or Individual Days from the drop-down menu.

 - 6 If you chose Individual Days, select the checkboxes for the desired days.
The Recurrence Pattern shows the rules created to date.

 - 7 If desired, click the plus sign (+) to add more rules.

 - 8 Click Save Changes.

 - 9 STOP. This procedure is complete.

8.3.4 Maintenance

G-240W-F ONTs also support maintenance tasks, including:

- password change
- LOID configuration
- SLID configuration

Procedure 55 Password configuration

A password must adhere to the password rules, which are as follows:

- the password may consist of uppercase letters, lowercase letters, digital numbers, and the following special characters `! # + , - / @ _ : =]`
- the password length must be from 8 to 24 characters
- the first character must be a digital number or a letter
- the password must contain at least two types of characters: numbers, letters, or special characters
- the same character must not appear more than 8 times in a row

When the password meets the password rules, the application displays the message “Your password has been changed successfully”.

When the password does not meet the password rules, the application displays a message to indicate which password rule has not been followed, for example:

- the password is too short
- the password is too long
- the first character cannot be a special character
- there are not enough character classes

- 1 Select Maintenance > Password from the top-level menu in the GPON Home Gateway window, as shown in Figure 77.

Figure 77 Password window

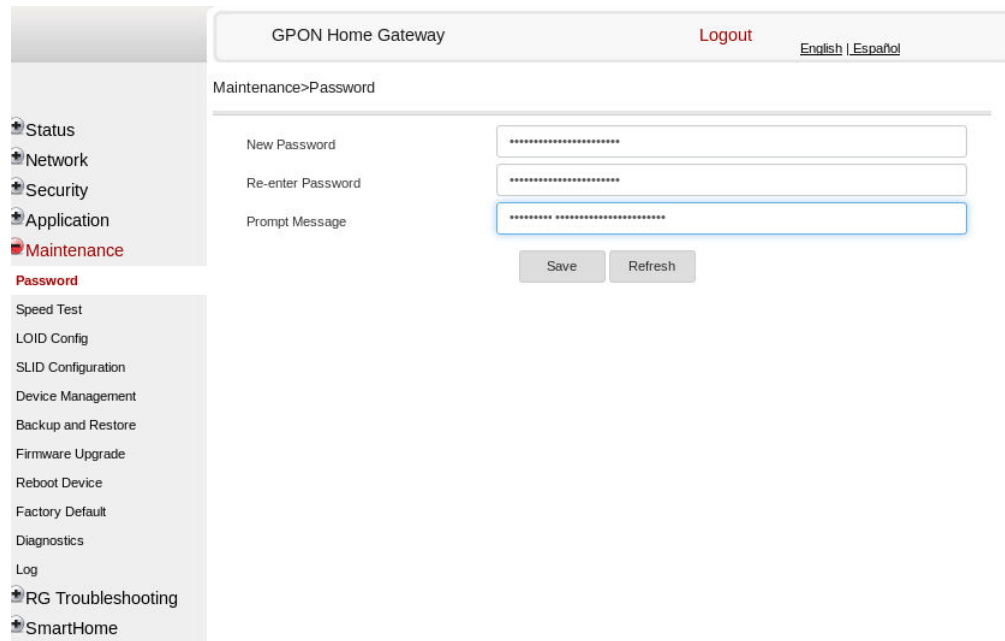

Table 51 describes the fields in the password window.

Table 51 Password parameters

Field	Description
New Password	New password (must adhere to the password rules described above)
Re-enter password	Must match the new password entered above exactly
Prompt message	Password prompt message

- 2 Configure the new password.

- 3 Click Save.
- 4 STOP. This procedure is complete.

Procedure 56 LOID configuration

- 1 Select Maintenance> LOID Config from the top-level menu in the SFU GPON Home Gateway window, as shown in Figure 78.

Figure 78 LOID Authentication window

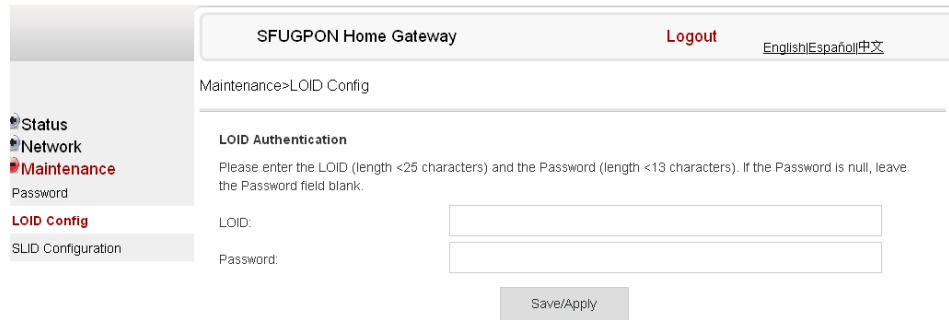

Table 52 describes the fields in the LOID configuration window.

Table 52 LOID configuration parameters

Field	Description
LOID	Type the LOID; the maximum number of characters is 24 If the password is null, this field may be left blank
Password	Type the password; the maximum number of characters is 12

- 2 Enter the LOID.
- 3 Enter the password, if applicable.

-
- 4 Click Save/Apply.
-
- 5 STOP. This procedure is complete.
-

Procedure 57 SLID configuration

- 1 Select Maintenance > SLID Configuration from the top-level menu in the SFU GPON Home Gateway window, as shown in Figure 79.

Figure 79 SLID configuration window

SFUGPON Home Gateway Logout [English/Español/中文](#)

Maintenance>SLID Configuration

Status
Network
Maintenance
 Password
 LOID Config
SLID Configuration

Current SLID: 44454641554C54

Enter New SLID:

SLID Mode: HEX Mode

Note:

ASCII Mode: Maximum of 10 ASCII characters allowed (e.g. abcdefg123)

HEX Mode: Maximum of 20 HEX numbers allowed (e.g. 1234567890ABCDEF1234)

Table 53 describes the fields in the SLID configuration window.

Table 53 SLID configuration parameters

Field	Description
Current SLID	Displays current SLID
Input new SLID	Enter new SLID
SLID Mode	Choose a SLID mode from the drop-down menu: HEX or ASCII In ASCII mode, the maximum number of characters is 12, for example: abcdefg123. In HEX mode, the maximum number of characters is 20, for example: 1234567890ABCDEF1234

-
- 2 Configure the new SLID.

-
- 3 Click Save.
-
- 4 STOP. This procedure is complete.
-

8.4 Operator ID

Use the procedure below to modify the operator ID for the G-240W-F.

Procedure 58 Modifying the operator ID

-
- 1 Register the ONT with the OLT.
-
- 2 Check the original OPID.
-
- 3 Update the OntConfig.xml file by adding-the following content:

```
<OperatorObject version="1.0">
<OperatorID="XXXX">
</OperatorObject>
```

where: xxxx is the correct operator ID, for example ALCL for HGU mode, or XXXX for SFU mode.
-
- 4 Use a TFTP client tool to transfer the OntConfi.xml file to the OLT's ONT directory and change the filename to the software version number, for example, 3FE123456789.xml.
-
- 5 Use a TL1 command to configure ONUSWCRTL:

```
ENT-ONTSWCTRL::1:::HWVER=hwver,VARNT=,PLNSWVER=UNPLANNED,
PLNSWVERCONF=UNPLANNED,DLD SWVER=swver;
```

where:
hwver is the EQPTVERNUM, for example EQPTVERNUM=3FE54945ABAA.
swver is the software version number used as the filename in step 2, for example 3FE123456789.xml.
-
- 6 Download the xml file to update the operator ID:

```
ED-ONT::ONT-1/1/3/1/19:::DLSW=AUTO;
```
-
- 7 Restart the ONT, then connect to the LAN and access the web-based GUI to check the operator ID default setting.

-
- 8** Use a TL1 command to disable further downloads:

```
ED-ONT::ONT-1/1/3/1/19:::DLSW=DISABLED::IS;
```

-
- 9** STOP. This procedure is complete.
-

9 ONT configuration file over OMCI

9.1 Purpose

9.2 Supported configuration file types

9.3 ONT configuration file over OMCI

9.1 Purpose

This procedure describes how to use configuration files over OMCI to configure ONTs. Some advantages include:

- flexibility to change the ONT default behavior by downloading configuration file
- flexibility to update a deployed ONT by downloading updated parameters
- ability to securely download any configuration file to an ONT
- ability to avoid using embedded configuration files in ONT software



Note — This feature is supported for use with the 7360 ISAM FX and the 7342 ISAM FTTU.

9.2 Supported configuration file types

Table [54](#) describes the configuration file types that are supported from 7368 ISAM ONT R05.02.00 and later.

Table 54 Supported configuration files

File Index	Description	Details	Supported ONTs/DPU
PRE	ONT pre-configuration file	<p>The XML-based PRECONFIG file controls the working mechanics of the ONT for various services. The default behavior of different ONTs may vary based on the factory settings.</p> <p>The pre-configuration file includes the factory default value for the residential gateway.</p> <p>Note: the pre-configuration file does not work with SFU ONTs; therefore, this feature applies only to Residential Gateway ONTs.</p> <p>The pre-configuration file can be used as is, but Nokia provides its customers with the flexibility to customize the pre-configuration file.</p> <p>This pre-configuration file enables operators to change the default behavior by downloading a customized pre-configuration based on customer inputs.</p> <p>This PRE XML file includes a custom OPERID.</p> <p>The Nokia defined index for the PRECONFIG file is: "PRE"</p>	HGU ONTs: G-240G-C, G-240W-F, G-240W-B, G-240W-C I-240W-A
CFG	ONT configuration delta file	<p>The XML-based CFG file updates the configurable parameters (the PRE settings) in the existing PRE file of a deployed ONT, where required.</p> <p>This configuration file enables operators to change the deployed behavior by downloading customized updates in the CFG file.</p> <p>This file is used only to modify the parameters in the PRE file; it is not used for service provisioning.</p> <p>No OPERID is required, because the update is based on the OPERID used for the PRE file.</p> <p>The Nokia defined index for the PRECONFIG DELTA file is: "CFG"</p>	
XML	Voice XML file	<p>The Voice XML file provides an alternate method for securely downloading voice parameters from the OLT, rather than using FTP (OMCIv1/OMCIv2) or HTTPS (TR-069). Downloading this file makes the applicable changes in the voice parameters.</p> <p>This file enables operators to change the voice behavior by downloading the updated voice XML file.</p> <p>Nokia recommends using this procedure, rather than embedded voice XML files.</p> <p>The Nokia defined index for the Voice XML file is: "XML"</p>	

(1 of 2)

File Index	Description	Details	Supported ONTs/DPU
GFT	G.fast-related configuration file	<p>This text-based json script file controls the default behavior of the G.Fast ONT.</p> <p>This file includes the provisioning parameters of the G.fast transports layer; it does not include VLAN or QoS provisioning.</p> <p>While the ONT functions well with the default values; they can optionally be customized.</p> <p>While default values can work in VDSL mode, a download file is required for the device to function as a G.fast ONT.</p> <p>The Nokia defined index for the G.fast file is: "GFT"</p>	HGU ONTs: G-240G-C, G-240W-F, G-240W-B, G-240W-C I-240W-A

(2 of 2)

9.2.1 Filename conventions

Nokia provides the raw configuration files, which must be saved by the operator in a TAR file to be uploaded. TAR file names must be unique.

The filenames of the raw configuration files may not adhere to the naming conventions outlined below. In this case, the files must be renamed to adhere to the naming conventions before the operator generates the TAR file. Filenames are not case-sensitive.

ABCXXXXVER

where

ABC is the file index type (PRE, CFG, XML, GFT)

XXXX is the operator ID

For PRE and CFG, a valid operator ID is required

For XML and GFT, any characters may be used

VER is the file version (from 001 to 999)

Note: you cannot update the configuration using two files with the same name.

9.3 ONT configuration file over OMCI



Warning — Executing the following procedure will trigger the ONT to reboot, which will impact ongoing services.

Use this procedure to configure ONTs using configuration files via OMCI.

Procedure 59 Configuring an ONT using a configuration file via OMCI

- 1 Generate the TAR file to be uploaded to the OLT.

Using the raw configuration file(s) provided by Nokia, generate the TAR file as follows:

- i On a Linux platform, rename the raw configuration file to adhere to the naming convention, as described in section 9.2.
- ii Tar the *ABCXXXXVER* raw configuration file:

```
tar -cf ABCXXXXVER.tar ABCXXXXVER
```

Where
ABCXXXXVER
Is the name of the file created in step i.

This creates two files: *ABCXXXXVER* and *ABCXXXXVER.tar*.

- iii Rename *ABCXXXXVER* to *ABCXXXXVER.org*
- iv Remove the “.tar” extension from *ABCXXXXVER.tar* file.

-
- 2 Upload the *ABCXXXXVER* TAR file to the /ONT/ directory in the OLT.

A maximum of 250 files can be kept in the OLT file system.

-
- 3 Using OLT commands, download the TAR file to the ONT.

For OLT commands, refer to the *7360 ISAM FX CLI Command Guide for 100_320Gbps FD NT and FX NT*, or the *7342 ISAM FTTU Operation and Maintenance Using TL1 and CLI*.

Please note:

- *pri-cfgfile-pland/dnload* or *sec-cfgfile-pland/dnload* can be 1 to 14 characters.
- *pri-cfgfile-pland* and *pri-cfgfile-dnload* should be the same name.

Examples

Note: X can be 1 or 2 unless specified:

- i If *pland-cfgfileX= Disabled* and *dnload-cfgfileX= Disabled*,
no file will be downloaded to the ONT.
- ii If *pland-cfgfileX=FILENAME1* and *dnload-cfgfileX= Disabled*,
FILENAME1 will be downloaded and *FILENAME1* will be made active. An ONT reboot is required.
- iii If *pland-cfgfileX=Disabled* and *dnload-cfgfileX= FILENAME2*

FILENAME2 will be downloaded and FILENAME2 will be made passive. An ONT reboot is not required.

iv If `pland-cfgfileX=FILENAME3` and `dnload-cfgfileX= FILENAME 4`, the OLT reports an error because the filenames are not the same.

v Configure equipment interface ... `pland-cfgfile1=XMLXXXXXX1` and `dnload-cfgfile1 XMLXXXXXX1`

Configure equipment interface ... `pland-cfgfile2=XMLXXXXXX2` and `dnload-cfgfile2 XMLXXXXXX2`

Although the OLT permits the above two steps without reporting an error, Nokia does not recommend executing them, because the ONT may exhibit unexpected behavior.

vi If `pland-cfgfileX=Auto` and `dnload-cfgfileX= Auto`

The OLT will download the XML file from "sw-ctr-list" (configure equipment ont sw-ctrl)

4 STOP. This procedure is complete.

The ONT will distribute the configuration files to the different services based on the active indication from the OLT and on the Nokia defined index.

The ONT automatically reboots to apply the configuration files. After the ONT reboots and reports the active version, the OLT completes the file download procedure.

Operators must check the committed file from the OLT to verify whether the corresponding file has been applied. If an error occurs, contact Nokia for support.

FCC Regulations:

- This device complies with part 15 of the FCC Rules. Operation is subject to the following two conditions: (1) This device may not cause harmful interference, and (2) this device must accept any interference received, including interference that may cause undesired operation.
- This equipment has been tested and found to comply with the limits for a Class B digital device, pursuant to part 15 of the FCC Rules. These limits are designed to provide reasonable protection against harmful interference in a residential installation. This equipment generates, uses and can radiate radio frequency energy and, if not installed and used in accordance with the instructions, may cause harmful interference to radio communications. However, there is no guarantee that interference will not occur in a particular installation. If this equipment does cause harmful interference to radio or television reception, which can be determined by turning the equipment off and on, the user is encouraged to try to correct the interference by one or more of the following measures:
 - —Reorient or relocate the receiving antenna.
 - —Increase the separation between the equipment and receiver.
 - —Connect the equipment into an outlet on a circuit different from that to which the receiver is connected.
 - —Consult the dealer or an experienced radio/ TV technician for help.
- Changes or modifications not expressly approved by the manufacturer could void the user's authority to operate the equipment.

FCC RF Radiation Exposure Statement

This equipment complies with FCC radiation exposure limits set forth for an uncontrolled environment. To comply with FCC RF Exposure compliance requirements, this grant is applicable to only Mobile Configurations. The antennas used for the transmitter must be installed to provide a separation distance of at least 20cm from all persons and must not be co-located or operating in conjunction with any other antenna or transmitter.

Customer document and product support

Customer documentation



[Customer Documentation Welcome Page](#)

Technical Support



[Customer Documentation Technical Support](#)

Documentation feedback



[Customer Documentation Feedback](#)