

# BF-01C

## User Manual

<b>Introduction</b>	<b>1</b>
<b>Installing the BF-01C</b>	<b>2</b>
<b>Wireless Connection to the BF-01C</b>	<b>3</b>
<b>Internet Connection Settings</b>	<b>4</b>
<b>Use Overseas</b>	<b>5</b>
<b>Troubleshooting</b>	<b>6</b>
<b>Appendix</b>	<b>7</b>

---

Thank you for purchasing the BF-01C.  
This manual describes product installation and its default settings. It also provides troubleshooting information. Please always read this manual before using the product.

# 1

## Introduction

---

### Main Features

This section describes the main product features.

- Supports NTT Docomo "Xi". (When receiving: Max. 37.5 Mbps; When sending: Max. 12.5 Mbps)
  - ※ The communication speeds are the maximum values in sending and receiving standards. However, these do not indicate actual communication speeds. Data transmission is provided over a best-effort network. For that reason, actual communication speeds may vary according to the communication environment and the traffic load on the network.
  - ※ When outside of the Xi area, this can also be used in a FOMA high-speed area (when receiving: Max. 7.2 Mbps; when sending: Max. 5.7 Mbps).
- The Internet connection automatically switches in public wireless LAN areas, such as Mzone, from the Xi line or FOMA line to the public wireless LAN.
- The included cradle provides a wired port connection, and recharges the product.
- Connects up to 10 wireless LAN devices, such as personal computers and game consoles.
- Connects to wireless LAN devices with one touch using AOSS or WPS.

### Operating Environment

This section describes the product operating environment.

#### Supported Devices

iPad, iPod touch, game console (Nintendo 3DS™, Nintendo DS®, PSP® "PlayStation Portable"), and devices that support wireless LAN.

## Supported OS (Personal Computers)

Windows 7 (32 bit/64 bit), Vista (32 bit/64 bit), XP (32 bit),  
Mac OS X (10.4/10.5/10.6)

- ※ Supports Windows 7 Starter/Home Premium/Professional/Ultimate.
- ※ Supports Windows Vista Home Basic/Home Premium/Business/Ultimate.
- ※ Windows XP must have Service Pack 3 or later installed.

## Supported Browsers

Internet Explorer 6/7/8/9

Firefox 3.5/3.6/4

Nintendo DS Browser, Nintendo DSi Browser

PSP® Internet Browser

Internet Explorer Mobile (Windows Mobile 6.x)

Opera Mobile 9/10

Safari 3/4/5 (Mac OS/iPod touch)

- ※ To change the product's settings, or to check the setting contents, use Internet Explorer 6/7/8/9, or Firefox 3.5/3.6/4 (Windows 7/Vista/XP). Browsers provided in game console or cell phones cannot implement all product settings.

# Main Unit Accessories

Before using this product, check that all of the accessories are included.

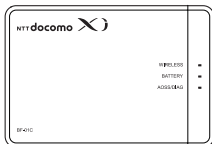

**Mobile Wi-Fi Router (BF-01C) Unit  
(Rear Cover BF01C, Includes Warrantee)**

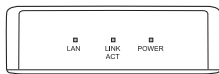

**Desktop Cradle BF01C (Includes  
Warrantee)**

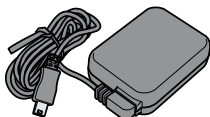

**AC Adapter BF01 (Includes Warrantee)**

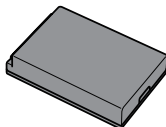

**Battery Pack BF01**

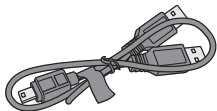

USB Cable BF01



LAN Cable (Free Sample)

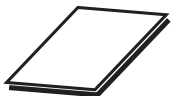

User Manual (This Manual)

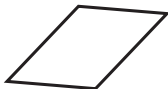

Mobile Device Connection Guide

**Note** If separate, additional information is included, refer to that.

# Part Names and Functions

## Front Panel

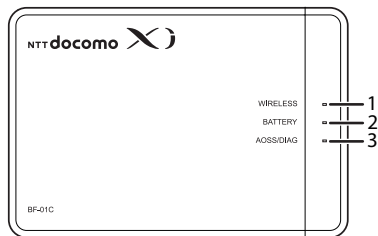

### 1. WIRELESS LED

Glowing (light blue)	:	When in Xi area
Glowing (purple)	:	When in FOMA international roaming area
Glowing (blue)	:	When in FOMA area
Glowing (green)	:	When in wireless LAN area
Glowing (red)	:	When outside of Xi area, FOMA line and wireless LAN area, and when not connected to wired Internet
Glowing (yellow)	:	When in power saving mode
Flashing (light blue)	:	When communicating on Xi line
Flashing (purple)	:	When communicating on FOMA international roaming line
Flashing (blue)	:	When communicating on FOMA line
Flashing (green)	:	When communicating on wireless LAN
Off	:	When connected to wired Internet

### 2. BATTERY LED

Glowing (blue)	:	Battery capacity is 50% or higher Recharging is completed and the power is turned on
Glowing (green)	:	Battery capacity is 50 - 25%
Glowing (red)	:	Battery capacity is 25 - 10%
Flashing (red)	:	Battery capacity is 10% or lower
Glowing (yellow)	:	Recharging
Off	:	Recharging is completed and the power is turned off

※ Battery capacity is a general indicator.

### 3. AOSS/DIAG LED

- Glowing (yellow) : Security key exchange succeeds (AOSS/WPS succeeds)/Wireless LAN security setting completed
- Flashing Two Times (blue) : This product can exchange security keys.  
(LAN Side: AOSS/WPS Idling)  
(Internet Side: AOSS Idling) \*1
- Continuous Flashing (blue) : Failed to exchange security keys (AOSS/WPS failed)
- Flashing (red) : The number of flashes indicates the status of the product.
- Off : Wireless LAN security is not set.

Flashing (red) status	Content	Status
Continuous Flashing *2	<ul style="list-style-type: none"><li>• Booting up system</li><li>• Updating the firmware</li><li>• Saving settings</li><li>• Initializing</li><li>• Accessing internal storage region</li></ul>	
Flashing Three Times *3	Wired LAN Error	Wired LAN controller is malfunctioning.
Flashing Four Times *3	Wireless LAN error	Wireless LAN controller is malfunctioning.
Flashing Five Times	IP Address Setting Error	Communication is not possible because the network addresses are the same on the Internet side and the LAN side. Change the product's LAN-side IP address setting.
Flashing Six Times	Temperature Error	The internal product temperature is high. Turn the power to the product off and allow it to cool for a while before using it.

- \*1 Devices idling with AOSS switch to flashing two times (yellow) when detected by the Internet side of the product.
- \*2 Do not turn off the power when the device is continuously flashing. Doing so can damage it.
- \*3 When the AC adapter is disconnected from the device, turn off the power to it, and remove the battery pack. Return the battery pack to its original position after waiting for a while.

## Side Panel

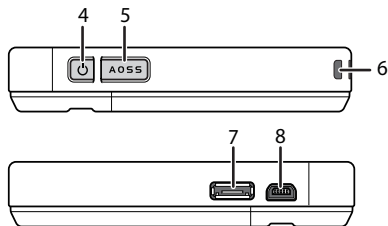

### 4. Power Button

When the power is off, hold down the power button for approximately three seconds to turn the power on. When operating this device, hold down the power button for approximately three seconds to turn the power off.

### 5. AOSS Button

When the power is on, hold down the button (for approximately three seconds) until the AOSS/DIAG LED flashes in blue to enter a status (AOSS operating status) where security keys can be exchanged.

### 6. Strap Hole

Attaches commercially available straps.

### 7. Cradle Connector

Connects the included cradle.



## 8. Mini USB Connector

Connects the included AC adapter or a USB cable.

# Back Side Panel

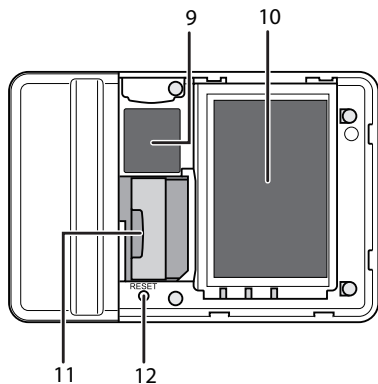

## 9. Default Value Label

Lists this unit's SSID (default value) and encryption key (default value) and the like.

## 10. Battery Box

Holds the included battery pack.

## 11. UIM Card Slot

For inserting a Docomo UIM card.

※ This device does not support the use of FOMA cards. If you have a FOMA card, please replace it from your Docomo vendor.

## 12. RESET Switch

When the power to this device is on, hold down the RESET button (for approximately three seconds) until the AOSS/DIAG LED flashes in red to initialize the settings.

## Cradle Front Side

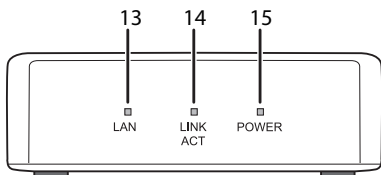

### 13. LAN LED

- |                 |   |   |
|-----------------|---|---|
| Glowing (green) | : | When the wired port is set as the LAN port      |
| Off             | : | When the wired port is set as the INTERNET port |

### 14. LINK/ACT LED

- |                  |   |                                      |
|------------------|---|--------------------------------------|
| Glowing (green)  | : | When the wired port is linked        |
| Flashing (green) | : | When the wired port is communicating |

### 15. POWER LED

- |                 |   |   |
|-----------------|---|---|
| Glowing (green) | : | When the included AC adapter is connected |
|-----------------|---|---|

## Cradle Top

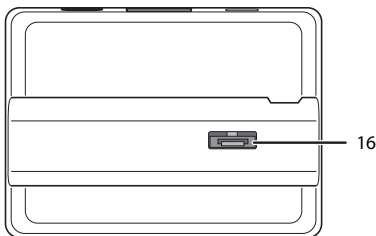

### 16. Cradle Connector

Connects the main unit's cradle connector.

# Cradle Back Side

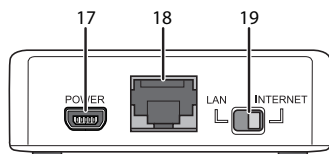

## 17. POWER Connector

Connects the included AC adapter.

## 18. Wired Port

Switch to operate this as the LAN port or the INTERNET port by using the on-off switch.

## 19. On-off Switch

Switch to use the wired port either as the LAN port or the INTERNET port.

# 2

## Installing the BF-01C

### Power ON/OFF

Turn the power ON/OFF using the power button.

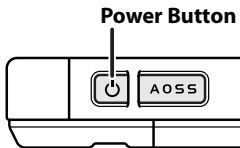

When the power is off, hold down the power button for approximately three seconds to turn the power on.

When operating this device, hold down the power button for approximately three seconds to turn the power off.

**Note** In the default setting, if no wireless device is connected to the product for approximately one minute, it will automatically switch to standby mode. Operations such as connecting to the Internet do not work while the unit is in standby mode. But the system will recover to its normal operating status either by pressing the power button or by connecting a wireless device to the product. However, the system will not shift to standby mode while power is being supplied or when it is connected to a wired port.

# 3

## Wireless Connection to the BF-01C

### Wireless Connection to a Personal Computer

This section describes the procedures for connecting this product wirelessly to a personal computer running Windows, using AOSS/WPS (push-button type) as an example. Setting methods vary according to the version of Windows that is running.

**Note** Refer to the Reference Guide for details on other connecting methods. See page 58 in this manual on reference method.

### For Windows 7/Vista

Follow the procedure below to connect to this device using AOSS/WPS (push-button type) on a personal computer running Windows 7 or Vista.

**Note** In setting AOSS/WPS (push-button type), the personal computer and this device establish a 1-to-1 relationship. For that reason, you cannot connect another device with AOSS/WPS (push-button type) while it is being set. To connect multiple devices to one BF-01C unit, connect another device after completing the AOSS/WPS (push-button type) connection.

- 1 Select [Start] - [(All) Programs] - [BUFFALO] - [AirStation Utility] - [Client Manager V].

- 2 When the screen below is displayed, click [Create connection destination].



- 3 When the "User Account Control" screen is displayed, click [Yes] or [Continue].



- 4 Click the automatic security setting button displayed in the screen.



displayed in the screen.



- 5 When the screen below is displayed, hold down the AOSS button for approximately 2 seconds until the AOSS/DIAG LED flashes. Release the button when the LED flashes.



- ※ The product image in the screen is an example. The product and AOSS button position may differ from your system, so check the position of the button in advance.

Hold down the AOSS button until the AOSS/DIAG LED flashes twice in blue.

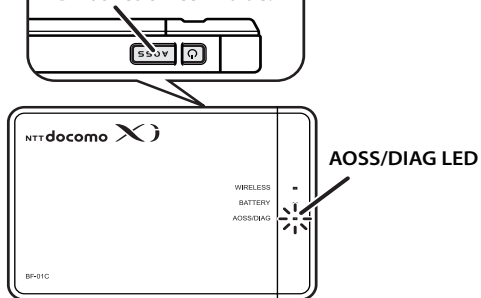

## 6 The device is automatically detected, and connected.



※ The product image in the screen is an example.



## 7 Wait for the connection to complete.



※ The product image in the screen is an example.

## 8 When "Connection with AOSS completed" or "Connection with WPS push-button type completed" is displayed, check the name of the connection destination, and click [Save and close].

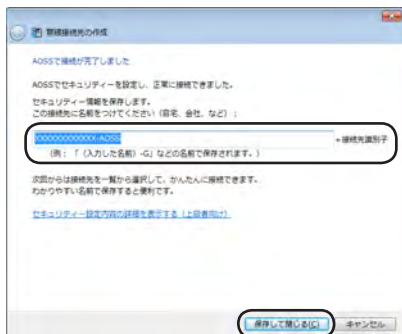

**Note** The connection destination name can be freely set.

- 9 When "Wireless connection destination creation completed" is displayed, click [Close].

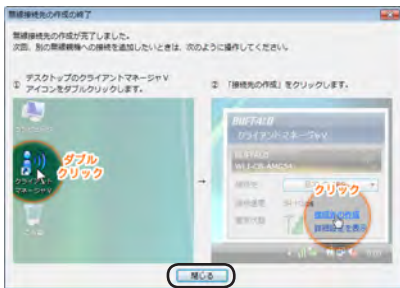

- 10 If a screen "Set Network Location" is displayed, click the location that matches the environment where the devices will be used. (In the example here, click "Home Network".)

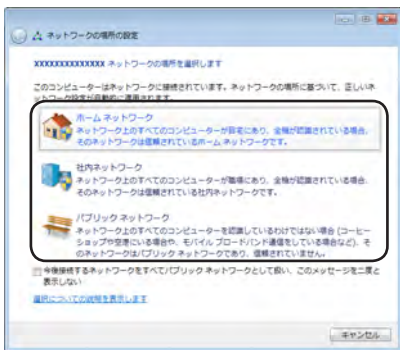

**11** If the "User Account Control" screen is displayed, click [Yes] or [Continue].

**12** If the screen below is displayed, click [Close].

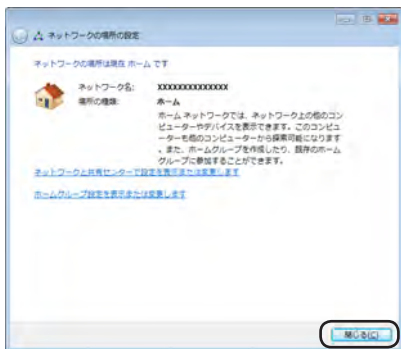

This completes connecting to this product.

**Note** If connecting to this device fails, the AOSS/DIAG LED will continuously flash in blue for approximately 30 minutes, and a screen like the one below is displayed. In such case, click "Start creating wireless connection from the beginning" and implement the procedures again from step 4 (Page14).

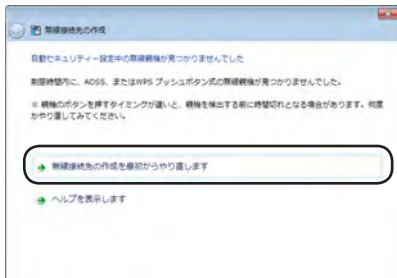

※ Sample screen.

# 4

## Troubleshooting

### Initializing the Settings

Use the following procedures to initialize the settings (Reset).

- 1** Check that the power to the device is on.
- 2** Remove the back side cover.
- 3** Hold down the RESET button (for approximately three seconds) until the AOSS/DIAG LED flashes in red.

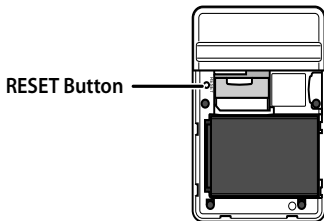

- 4** After about one minute, check that the AOSS/DIAG LED is lit in yellow.

This completes initialization of this product.

# 5

## Appendix

### Product Specifications

#### Main Unit/Cradle

Wireless Interface (LAN Side)	Compliance Standards	IEEE802.11b / IEEE802.11g / IEEE802.11n ARIB STD-T66 (IEEE802.11b/g)
	Maximum Data Transfer Speed (Theoretical Value)	IEEE802.11b 11Mbps IEEE802.11g 54Mbps IEEE802.11n 150Mbps
	Mode	Access Point (AP) Mode
	Frequency Range	2412 - 2472 MHz 1 - 13 channels * When being used overseas (international roaming), the range is restricted to 2412 - 2462MHz and 1 - 11 channels. * Basically, signals do not cross-talk (or interfere) with those of other devices, such as cell phones, cordless telephones, televisions, radios and the like, but if these devices are wireless with a 2.4 GHz band, there is the possibility that cross-talk can occur.
	No. of Ports	1 Port
	No. of Devices That Can Be Connected Simultaneously	10 Devices
	Security	WPA2-PSK (TKIP/AES), WPA-PSK (TKIP/AES), WPA/WPA2 mixed PSK (TKIP/AES mixed mode), WEP (64bit/128bit) privacy separator, ANY connection rejection, MAC access restrictions (up to 16 devices)

<b>Wireless Interface (Internet Side)</b>	<b>Compliance Standards</b>	IEEE802.11a / IEEE802.11b / IEEE802.11g / IEEE802.11n ARIB STD-T71 (IEEE802.11a) ARIB STD-T66 (IEEE802.11b/g)		
	<b>Maximum Data Transfer Speed (Theoretical Value)</b>	IEEE802.11a	54Mbps	
		IEEE802.11b	11Mbps	
		IEEE802.11g	54Mbps	
		IEEE802.11n	150Mbps	
		* IEEE802.11a cannot be used when the device is set for international roaming.		
<b>Mode</b>	Station (STA) Mode			
<b>Frequency Range</b>	5 GHz Band	W52	36/40/44/48 channels (5180 - 5240MHz)	
		W53	52/56/60/64 channels (5260 - 5320MHz)	
	2.4 GHz Band		1 - 13 channels (2412 - 2472MHz)	
	* When the device is being used overseas (international roaming), the range is restricted to 2412 - 2462MHz and 1 - 11 channels. Also, cannot be used in 5GHz band.			
	* Basically, signals do not cross-talk (or interfere) with those of other devices, such as cell phones, cordless telephones, televisions, radios and the like, but if these devices are wireless with a 2.4 GHz band, there is the possibility that cross-talk can occur.			
<b>No. of Ports</b>	1 Port			
<b>Security</b>	WPA2-EAP (TKIP/AES), WPA-EAP (TKIP/AES), WPA2-PSK (TKIP/AES), WPA-PSK (TKIP/AES), WPA/WPA2 mixed PSK (TKIP/AES mixed mode), 802.1X/EAP (WEP), WEP (64bit/128bit)			



<b>Continuous Communication Time</b>	<b>When Communicating</b>	When in LTE Communication Approximately 4 Hours When in 3G communication Approximately 6 Hours * Operating times vary according to the environment of use.
	<b>When in Standby</b>	Approximately 30 Hours * Operating times vary according to the environment of use.
<b>Operating Environment</b>		Temperature: 0 - 35°C Humidity: 10 - 85% (no condensation)
<b>External Dimensions</b>	<b>Main Unit</b>	Approximately 95.0 (W) x 64.4 (H) x 17.4 (D) mm
	<b>Cradle</b>	Approximately 64.3 (W) x 21.2 (H) x 48.3 (D) mm
<b>Weight</b>	<b>Main Unit</b>	Approximately 127 g (When battery pack is installed)
	<b>Cradle</b>	Approximately 35g

Software licensed by GNU General Public License (GPL) or GNU Lesser General Public License (LGPL) is included with this product. For details on this software, see NTT's homepage (<http://www.nttdocomo.co.jp/>).

## Battery Pack

Part Name	Battery Pack BF01
Battery Type	Lithium-ion Battery
Nominal Voltage	DC 3.7 V
Nominal Capacity	1880 mAh

## AC Adapter

Part Name	AC Adapter BF01
Input	AC100 - 240V 50/60Hz 11.2 - 14.8VA
Output	DC 5V 1 A



## Export Administration Regulations

This product and its accessories may be subject to Japan's Export Administration Regulations (Foreign Exchange and Foreign Trade Control Law). It also may be subject to American Re-exporting Regulations (Export Administration Regulations). To export or re-export this product and its accessories, use the necessary procedures at your own responsibility and cost. For details on procedures, please contact the Ministry of Economy, Trade and Industry or the U.S. Department of Commerce.

## Regulatory Information

### Federal Communications Commission (FCC) Statement

15.21

You are cautioned that changes or modifications not expressly approved by the part responsible for compliance could void the user's authority to operate the equipment.

15.105(b)

This equipment has been tested and found to comply with the limits for a Class B digital device, pursuant to part 15 of the FCC rules. These limits are designed to provide reasonable protection against harmful interference in a residential installation. This equipment generates, uses and can radiate radio frequency energy and, if not installed and used in accordance with the instructions, may cause harmful interference to radio communications. However, there is no guarantee that interference will not occur in a particular installation. If this equipment does cause harmful interference to radio or television reception, which can be determined by turning the equipment off and on, the user is encouraged to try to correct the interference by one or more of the following measures:

- Reorient or relocate the receiving antenna.
- Increase the separation between the equipment and receiver.
- Connect the equipment into an outlet on a circuit different from that to which the receiver is connected.
- Consult the dealer or an experienced radio/TV technician for help.

**This device complies with Part 15 of the FCC Rules.**

**Operation is subject to the following two conditions:**

- 1) this device may not cause harmful interference and
- 2) this device must accept any interference received, including interference that may cause undesired operation of the device.

**FCC RF Radiation Exposure Statement:**

For body worn operation, this device has been tested and meets FCC RF exposure guidelines when used with an accessory that contains no metal and that positions the device a minimum of 1.0 cm from the body. Use of other accessories may not ensure compliance with FCC RF exposure guidelines.

SAR information: **0.181** W/Kg (1g)

# CE Marking

This device has been tested to and conforms to the regulatory requirements of the European Union and has attained CE Marking. The CE Mark is a conformity marking consisting of the letters "CE". The CE Mark applies to products regulated by certain European health, safety and environmental protection legislation. The CE Mark is obligatory for products it applies to: the manufacturer affixes the marking in order to be allowed to sell his product in the European market.

This product conforms to the essential requirements of the R&TTE directive 1999/5/EC in order to attain CE Marking. A notified body has determined that this device has properly demonstrated that the requirements of the directive have been met and has issued a favorable certificate of expert opinion. As such the device will bear the notified body number 0560 after the CE mark

The CE Marking is not a quality mark. Foremost, it refers to the safety rather than to the quality of a product. Secondly, CE Marking is mandatory for the product it applies to, whereas most quality markings are voluntary.

Marking: The product shall bear the CE mark, the notified body number(s) as depicted to the right. CE 0560.

SAR information: **0.721** W/Kg (10g)