

MSI MP54G4 (MS-6833A)

Wireless 11g MiniPCI Card

User's Guide

FCC Caution

1. The device complies with Part 15 of the FCC rules. Operation is subject to the following two conditions:
 - (1) This device may not cause harmful interference, and
 - (2) This device must accept any interference received, including interference that may cause undesired operation.
2. FCC RF Radiation Exposure Statement: The equipment complies with FCC RF radiation exposure limits set forth for an uncontrolled environment. This equipment should be installed and operated with a minimum distance of 20 centimeters between the radiator and your body.
3. This Transmitter must not be co-located or operating in conjunction with any other antenna or transmitter.
4. Changes or modifications to this unit not expressly approved by the party responsible for compliance could void the user authority to operate the equipment.

***NOTE:** This device is approved for OEM installation with specified antennas as listed in this Manual. It is the responsibility of the Installer to comply with the separation distance for satisfying RF exposure compliance.*

Copyright Notice

The material in this document is the intellectual property of **MICRO-STAR INTERNATIONAL**. We take every care in the preparation of this document, but no guarantee is given as to the correctness of its contents. Our products are under continual improvement and we reserve the right to make changes without notice.

Trademarks

- 🕒 Microsoft Windows and Internet Explorer are registered trademarks or trade marks of Microsoft Corporation.
 - 🕒 All brand names, icons, and trademarks used in this manual are the sole property of their respective owners.
-

Important Safety Precautions

Always read and follow these basic safety precautions carefully when handling any piece of electronic component.

1. Keep this User's Manual for future reference.
2. Keep this equipment away from humidity.
3. Lay this equipment on a reliable flat surface before setting it up.
4. The openings on the enclosure are for air convection hence protects the equipment from overheating.
5. All cautions and warnings on the equipment should be noted.
6. Never pour any liquid into the opening that could damage or cause electrical shock.
7. If any of the following situations arises, get the equipment checked by a service personnel:
 - Liquid has penetrated into the equipment
 - The equipment has been exposed to moisture
 - The equipment has not work well or you can not get it work according to User's Manual
 - The equipment has dropped and damaged
 - If the equipment has obvious sign of breakage
8. DO NOT LEAVE THIS EQUIPMENT IN AN ENVIRONMENT UNCONDITIONED, STORAGE TEMPERATURE ABOVE 60°C OR BELOW -20°C, IT MAY DAMAGE THE EQUIPMENT.

Technical Support

- Visit the MSI website for FAQ, technical guide, driver and software updates, and other information: <http://www.msi.com.tw/>.
 - Contact our technical staff at: support@msi.com.tw.
-

FCC STATEMENT:

This device is intended only for OEM integrators under the following conditions:

- 1) The antenna must be installed such that 20 cm is maintained between the antenna and users, and
- 2) The transmitter module may not be co-located with any other transmitter or antenna.

As long as 2 conditions above are met, further transmitter test will not be required. However, the OEM integrator is still responsible for testing their end-product for any additional compliance requirements required with this module installed (for example, digital device emissions, PC peripheral requirements, etc.).

IMPORTANT NOTE:

In the event that these conditions can not be met (for example certain laptop configurations or co-location with another transmitter), then the FCC authorization is no longer considered valid and the FCC ID can not be used on the final product. In these circumstances, the OEM integrator will be responsible for re-evaluating the end product (including the transmitter) and obtaining a separate FCC authorization. End Product Labeling This transmitter module is authorized only for use in device where the antenna may be installed such that 20 cm may be maintained between the antenna and users (for example access points, routers, wireless ADSL modems, and similar equipment). The final end product must be labeled in a visible area with the following: "Contains TX FCC ID : I4L-MS6833A".

Manual Information for End Users

The end user must not have manual instructions to remove or install the device. The user manual for end users must include the following information in a prominent location: "IMPORTANT NOTE: To comply with FCC RF exposure compliance requirements, the antenna used for this transmitter must be installed to provide a separation distance of at least 20 cm from all persons and must not be co-located or operating in conjunction with any other antenna or transmitter."

1

Introduction

>>> 1.1 MP54G4 (MS-6833A) - Wireless 11g MiniPCI Card

MSI MP54G4 (MS-6833A) Wireless 11g MiniPCI Card (hereafter called MP54G4), compliant with IEEE802.11g, is a high-efficiency wireless adapter for wireless networking at home, in office or in public places. The data rate can be up to 54 Mbps and auto-negotiated to 48, 36, 24, 18, 12, 9, 6Mbps (IEEE 802.11g), or 11, 5.5, 2, 1Mbps (IEEE802.11b).

With MP54G4, you can roam between conference room and office without being disconnected the LAN cables; in addition, sharing files and printers can be easy tasks.

The MP54G4 is available to Microsoft Windows operating systems (Windows® XP/2000/ME/98SE) and can be integrated into networking with either **Ad-hoc mode** (computer-to-computer, without an Access Point) or **Infrastructure mode** (computer-to-access point, an Access Point is required).

>>> 1.2 How MP54G4 Works

- Q **Ad-hoc Mode** : An Ad-hoc network is a local area network or other small network, especially one with wireless or temporary plug-in connections, in which some of the network devices are part of the network only for the duration of a communications session. Users in the network can share files, print to a shared printer, and access the Internet with a shared modem. In this kind of network, new devices can be quickly added; however, users can only communicate with other wireless LAN computers that are in this wireless LAN workgroup, and are within range.

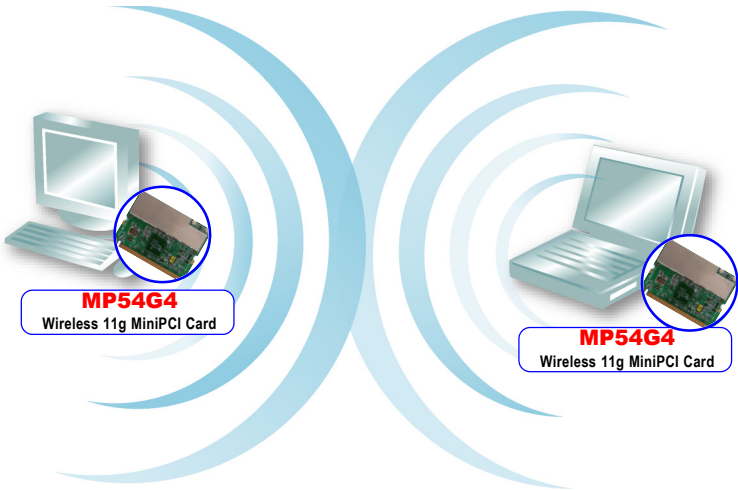

Infrastructure Mode : The difference between Infrastructure network and Ad-hoc network is that the former one includes an Access Point. In an Infrastructure network, the Access Point can manage the bandwidth to maximize bandwidth utilization. Additionally, the Access Point enables users on a wireless LAN to access an existing wired network, allowing wireless users to take advantage of the wired networks resources, such as Internet, email, file transfer, and printer sharing. The scale and range of the Infrastructure network are larger and wider than that of the Ad-hoc networking.

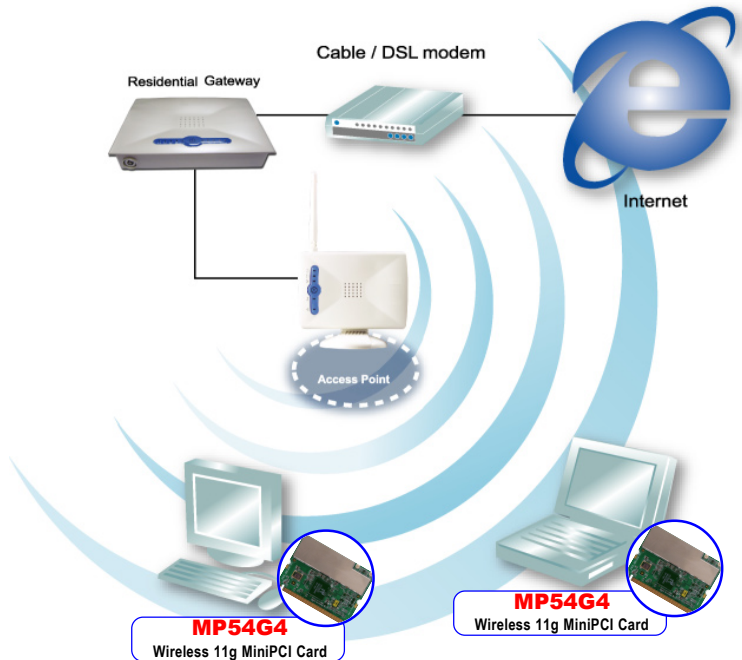

>>> 1.3 Specifications

📍 Hardware Specifications

Compliant Standards

- IEEE 802.11g/b

Bus and Connector Types

- 32-bit 3.3 Volt Type IIIB
- 124-pin Golden Finger

Security Mechanism

- Hardware-Base WEP Privacy
- Hardware-Base AES Privacy (driver update)

Operational Environment

- Operational Temperature: 0 ~ 55°C
- Humidity: 10 ~ 90% (Non-Condensing)

Weight and Dimension

- Weight: 15g
- Dimension: 44.9 x 59.6 x 3.5mm

📍 Radio Frequency Specifications

Raw Data Rates and Modulation Types

- IEEE 802.11b (Auto-Fallback)
 - CCK: 11 and 5.5 Mbps
 - DQPSK: 2 Mbps
 - DBPSK: 1 Mbps
- IEEE 802.11 g (Auto-Fallback)
 - OFDM: 54, 48, 36, 24, 18, 12, 9, 6Mbps

Communication Protocol

- DSSS (Direct Sequence Spread Spectrum) with ACK
- Half-Duplex

Access Method

- Infrastructure Mode: Station-To-LAN Architecture
- Ad-Hoc Mode: Station-To-Station Architecture

Frequency, Bandwidth, and Channels

- 2.4 ~ 2.4835 GHz Frequency Band
- 13 Channels
- Maximum 3 Non-Overlapped Channels
- 25 MHz Bandwidth Per Channel

Transmitter Output Power

- Output Power: 14 dBm \pm 1 dB

Wireless Coverage

- Up to 500m

Receiving Sensitivity

- \leq -82 dBm @ 11 Mbps (DSSS/CCK)
- \leq -68 dBm @ 54 Mbps (OFDM)

📍 Software Specifications

Security Mechanism

- 64/128 bit WEP Key
- AES-CCM Authentication Mode (driver update)
- WPA Support (driver update)
- LEAP/PEAP Support (firmware upgrade)

Authentication Mechanism

- Open Authentication (Default)
- Shared-Key Authentication

Operating System

- Microsoft® Windows® 98SE/ME/2000/XP

>>> 1.4 System Requirements

Before installing the MP54G4, your PC should meet the following:



Desktop/notebook PC with an available MiniPCI slot.



Windows® 98SE/ME/2000/XP operating system.

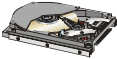

Minimum 5M bytes free disk space for installing the driver and utilities.



CD-ROM drive, double speed or higher.

>>> 1.5 Package Contents

Unpack the package and check all the items carefully. If any item contained is damaged or missing, please contact your local dealer as soon as possible. Also, keep the box and packing materials in case you need to ship the unit in the future. The package should contain the following items:



One Wireless 11g MiniPCI Card - **MP54G4**.



One Quick Installation Guide.



One Installation CD including drivers, utilities, and the manuals.

>>> 1.6 Product View

*External antenna connectors
Connect to external antennas for
enhanced data transmission and
reception. The external antennas
are well designed on the desktop
or notebook computers.*

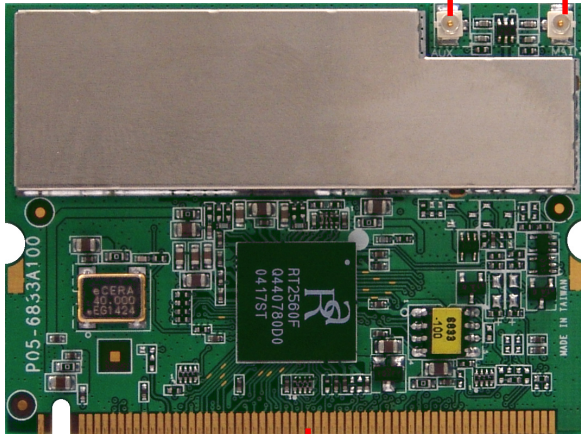

Golden Finger

2

Hardware Installation

The following diagrams provide you a basic installation for the MP54G4, including how to install and remove the MiniPCI card. The instruction below is suitable for most computers with MiniPCI slot. For more information about the MiniPCI module, please refer to your computer's manual.

>>> 2.1 Installing the MP54G4

1. Locate the Mini PCI slot on the mainboard.
2. Place the MP54G4 over the MiniPCI slot (at an angle of 30 degrees). Then, gently insert it into the slot until the golden finger of the card gets fully inserted.
3. Press down the card, and the retaining clips (on two sides of the slot) will lock onto the notches of the card.

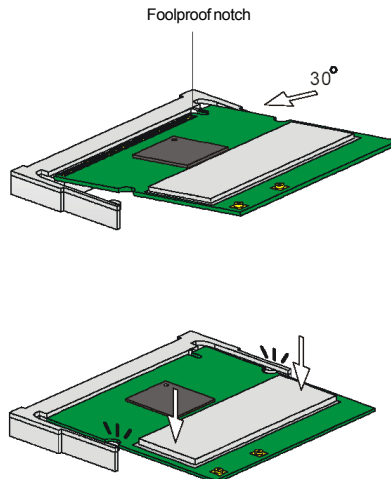

>>> 2.2 Removing the MP54G4

1. Locate the MiniPCI slot with MP54G4 installed.
2. Press the retaining clips outwards, and the card should bound upwards slightly after being released from the slot.
3. Remove the card from the MiniPCI slot carefully.

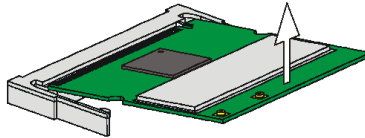
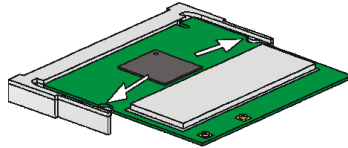

3

Software Installation

This chapter describes the procedures of installing the driver and utility. Follow the instruction step by step to finish the installation. If you use Windows® 98SE/ME, please prepare the Windows® Setup CD at hand before installing the driver; because the system will ask you to insert the Setup CD to copy files during the installation.

Please **NOTE** that the MP54G4 should be installed into your computer before installing the driver and utility. Then, the operating system will detect a new device and start to configure the new device. Click **Cancel** here to start installation from the InstallShield Wizard.

Tip: The wireless LAN adapter should be installed into your PC before installing the driver and utility.



Step 1. Insert the software CD into your CD-ROM drive, and the Setup program should launch automatically.

If the Autorun program doesn't launch automatically, click **Start** at the taskbar and select **Run....** Type **E:\setup.exe** (where **E** is your CD-drive) in the Open box and click **OK** to launch the Setup program manually.

The main screen of Setup program will appear as below. Click the **Install Software** button.



Step 3. The welcome screen of InstallShield Wizard appears. Click **Next**.

Read and accept the License Agreement; then, click **Next**.

In the following window, enter the user's information (*User Name*, *Organization*) in the respective fields; then, click **Next**.

Step 2. Click **Install** and the program will copy the necessary files to the system. The progress indicator shows the installing status.

If you use Windows 98SE/ME, you may be asked to insert the Windows Setup CD during the installation. Please insert the Setup CD by the on-screen instruction to continue the installation.

Step 4. Click **Finish** when the installation is completed. The **MSI Wireless LAN icon*** will appear in the status area.



MSI Wireless LAN icon