

DC-A11 Wireless Docking with AW-NU120 Dongle

User Manual

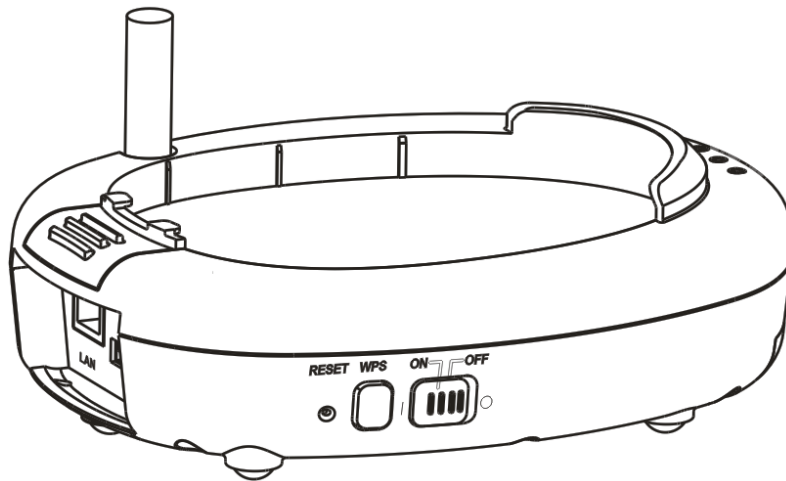

[Important]

Please visit Lumens
<http://www.lumens.com.tw/goto.htm> to
download the latest software, drivers, and
documentation

Table of contents

Copyright Information	3
Chapter 1 Safety Instructions	4
Safety Precautions	5
FCC Warning.....	5
EN55022 (CE Radiation) Warning	6
Revisions	6
Chapter 2 Package Contents	7
Chapter 3 Product Overview	8
3.1 Settle the USB connector	8
Chapter 4 Installation and Connections	9
4.1 Installing DC-120	9
4.2 Installing Dongle	10
4.3 Connect to a computer by using a wireless USB Dongle	11
4.4 Use a network cable to connect to a computer	11
4.5 Installing application software	12
Chapter 5 Start Using	21
Chapter 6 Function Menu	22
6.1 General.....	22
6.2 Profile	23
6.3 Available Network.....	24
6.4 Status.....	24
6.5 Statistics	25
6.6 Wi-Fi Protected Setup (WPS).....	25
Chapter 7 Descriptions of Major Functions	26
7.1 I would like to configure DC-A11 connection settings on the Internet	26

7.2	I would like to change the login password.....	26
7.3	I would like to change the SSID and Channel.....	26
7.4	I would like to check the WPS connection settings.....	27
7.5	I would like to update the firmware.....	27
Chapter 8 LED Light Indicators		28
Chapter 9 Troubleshooting.....		29

Copyright Information

Copyrights © Lumens Digital Optics Inc. All rights reserved.

Lumens is a trademark that is currently being registered by Lumens Digital Optics Inc.

Copying, reproducing or transmitting this file is not allowed if a license is not provided by Lumens Digital Optics Inc. unless copying this file is for the purpose of backup after purchasing this product.

In order to keep improving the product, Lumens Digital Optics Inc. hereby reserves the right to make changes to product specifications without prior notice. The information in this file is subject to change without prior notice.

To fully explain or describe how this product should be used, this manual may refer to names of other products or companies, nevertheless without any intention of infringement.

Disclaimer of warranties: Lumens Digital Optics Inc. is neither responsible for any possible technological, editorial errors or omissions, nor responsible for any incidental or related damages arising from providing this file, using, or operating this product.

Chapter 1 Safety Instructions





Always follow these safety instructions when setting up and using the Wireless Flyer:

1. Do not place Wireless Flyer in tilted position.
2. Do not place the Wireless Flyer on an unstable trolley, stand or table.
3. Do not use the Wireless Flyer near water or source of heat.
4. Use attachments only as recommended.
5. Use the type of power source indicated on the Wireless Flyer. If you are not sure of the type of power available, consult your dealer or local electricity company for advice.
6. Place the Wireless Flyer on a place that it can be unplugged easily.
7. Always take the following precautions when handling the plug. Failure to do so may result in sparks or fire.
 - Ensure the plug is free of dust before inserting it into a socket.
 - Ensure that the plug is inserted into the socket securely.
8. Do not overload wall sockets, extensions leads or multi-way plug boards as this may cause fire or electric shock.
9. Do not place the Wireless Flyer where the cord can be stepped on as this may result in fraying or damage to the lead or the plug.
10. Unplug the projector from the wall socket before cleaning. Use a damp cloth for cleaning. Do not use liquid or aerosol cleaners.
11. Do not block the slots and openings in the projector case. They provide ventilation and prevent the Wireless Flyer from overheating. Do not place the Wireless Flyer on a sofa, rug or other soft surface or in a built-in installation unless proper ventilation is provided.
12. Never push objects of any kind through cabinet slots. Never allow liquid of any kind to spill into the Wireless Flyer.
13. Except as specifically instructed in this User Manual, do not attempt to operate this product by yourself. Opening or removing covers may expose you to dangerous voltages and other hazards. Refer all servicing to licensed service personnel.
14. Unplug the Wireless Flyer during thunderstorms or if it is not going to be used for an extended period, do not place the Wireless Flyer or remote control on top of heat-emitting equipment or heated objects such as a car and etc.
15. Unplug the Wireless Flyer from the wall outlet and refer serving to licensed service personnel when the following situations happen:
 - If the power cable or plug becomes damaged or frayed.
 - If liquid is spilled into it or the Wireless Flyer has been exposed to rain or water.

<Note> Do not remove the battery of Wireless Flyer. In case of any failure, please contact the original manufacturer for maintenance service.

■ Safety Precautions

Warning: To reduce the risk of fire or electric shock, do not expose this appliance to rain or moisture.

		<table border="1"><tr><td style="text-align: center;">Note</td></tr><tr><td style="text-align: center;">Risk of Electric Shock</td></tr></table>	Note	Risk of Electric Shock		
Note						
Risk of Electric Shock						
Note: To reduce the risk of electric shock. Do not remove cover (or back). No user-serviceable parts inside. Refer servicing to licensed service Personnel.						
	This symbol indicates that this equipment may contain dangerous voltage which could cause electric shock.		This symbol indicates that there are important operating and maintenance instructions in this User Manual with this unit.			

■ FCC Warning

This equipment has been tested and found to comply with the limits for a Class A (Docking) or Class B (Dongle) digital device, pursuant to Part 15 of FCC Rules. These limits are designed to provide reasonable protection against harmful interference in a residential installation.

This device complies with Part 15 of the FCC Rules. Operation is subject to the following two conditions:

- (1) This device may not cause harmful interference.
- (2) This device must accept any interference received, including interference that may cause undesired operation.

This transmitter(Dongle) must not be co-located or operating in conjunction with any other antenna or transmitter. This device complies with internationally recognized standards covering Specific Absorption Rate (SAR) related to human exposure to electromagnetic fields from radio devices.

The maximum level of Specific Absorption Rate (SAR) measured is 0.620W/kg.

Class A digital device. A digital device that is marketed for use in a commercial, industrial or business environment, exclusive of a device which is marketed for use by the general public or is intended to be used in the home.

CAUTION
RISK OF EXPLOSION IF BATTERY IS REPLACED
BY AN INCORRECT TYPE.
DISPOSE OF USED BATTERIES ACCORDING
TO THE INSTRUCTIONS.

■ **EN55022 (CE Radiation) Warning**

This product is intended for use in a commercial, industrial, or educational environment. It is not intended for residential use.

This is a Class A product. In a domestic environment it may cause radio interference, in which case the user may be required to take adequate measures. The typical use is in a conference room, meeting room or auditorium.

Revisions

Chapter 2 Package Contents

DC-A11

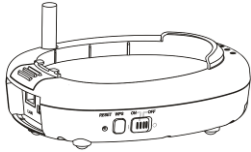

Dongle

Quick Start Guide

(To download this manual in other languages, visit Lumens website)



AC Adapter

CD

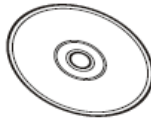

Power Cord



USB Connection Cable

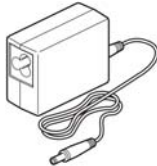

Appearance may vary depending on country/region

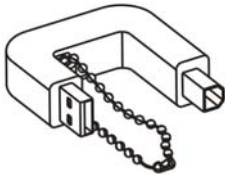

Chapter 3 Product Overview

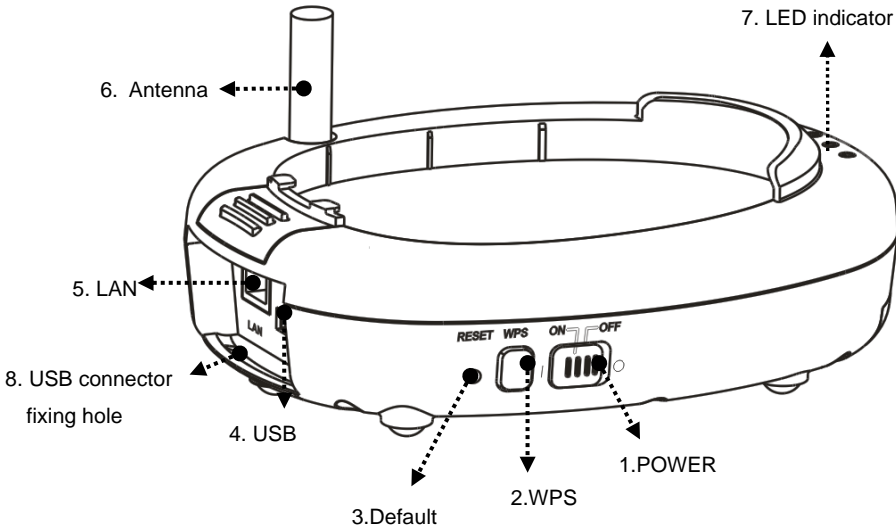

3.1 Settle the USB connector

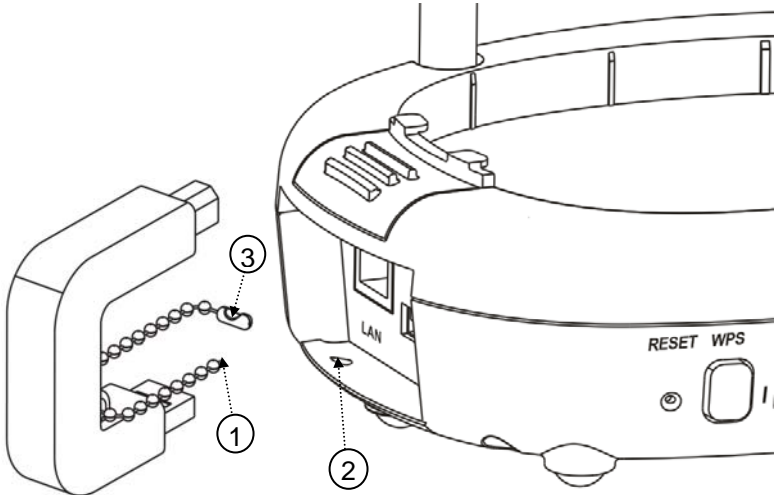

1. Disconnect the ball chain on the USB connector holder.
2. Thread the ball chain through the connector fixing hole on DC-A11.
3. Shackle the ball chain.

Chapter 4 Installation and Connections

4.1 Installing DC-120

1.

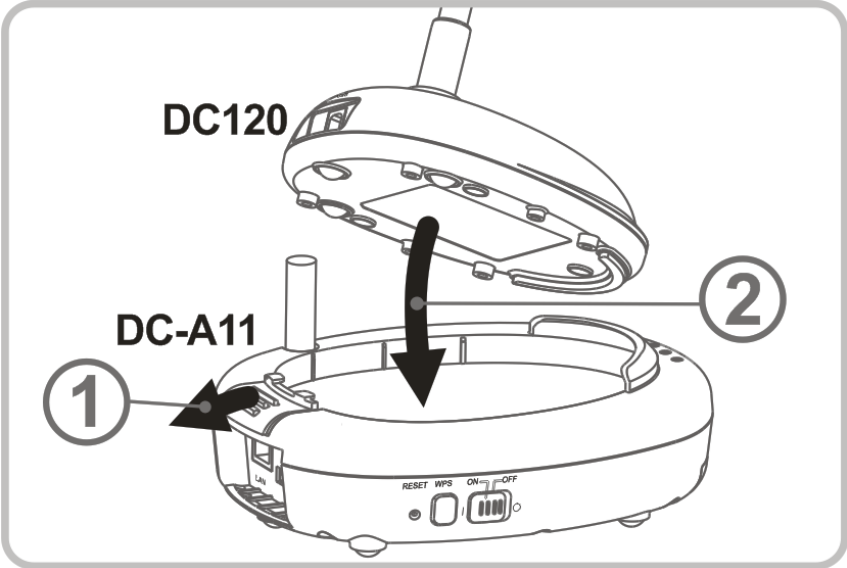

2.

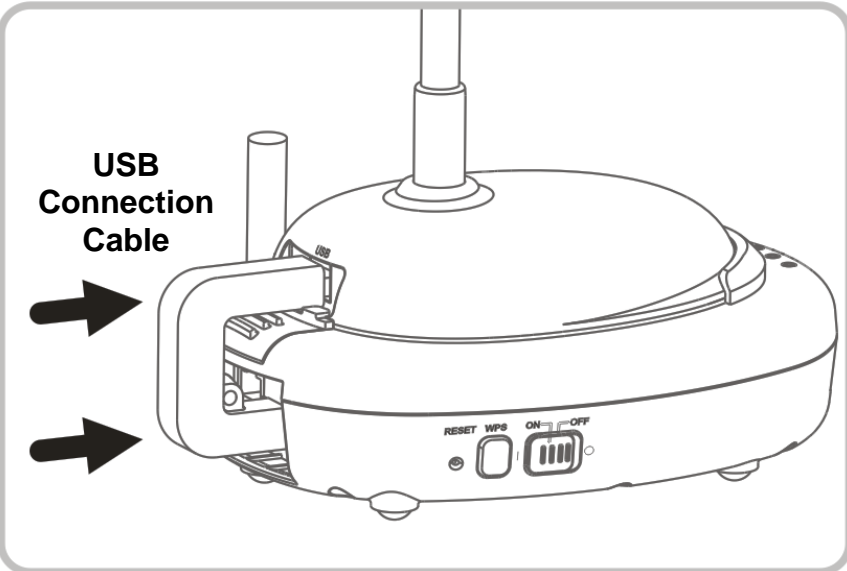

4.2 Installing Dongle

4.2.1 Pull out the Dongle and remove the protective film

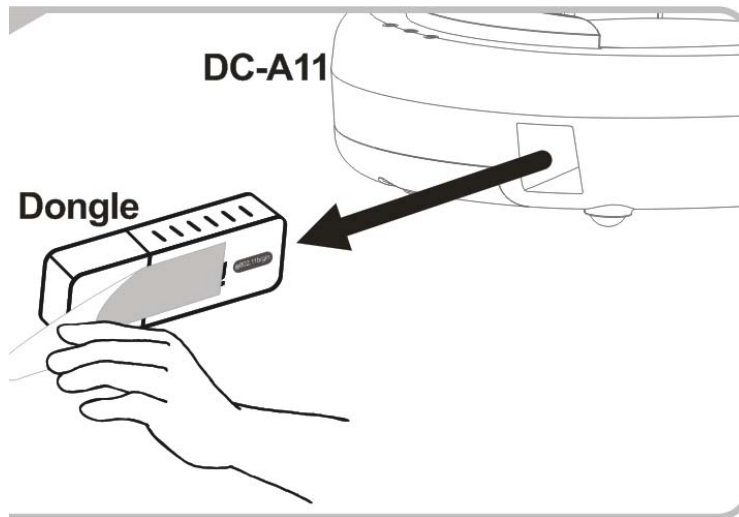

4.2.2 Installing the Dongle into the USB port on a computer

[Note] If the preview of Ladibug™ is opened, do not unplug the Dongle directly from the computer. You should unplug the Dongle after the Ladibug™ is closed.

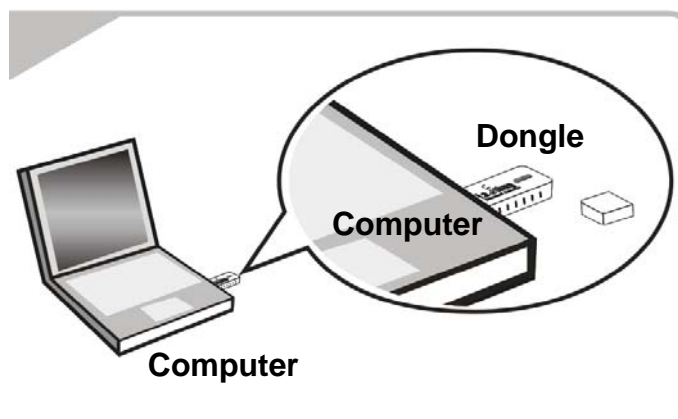

4.3 Connect to a computer by using a wireless USB Dongle

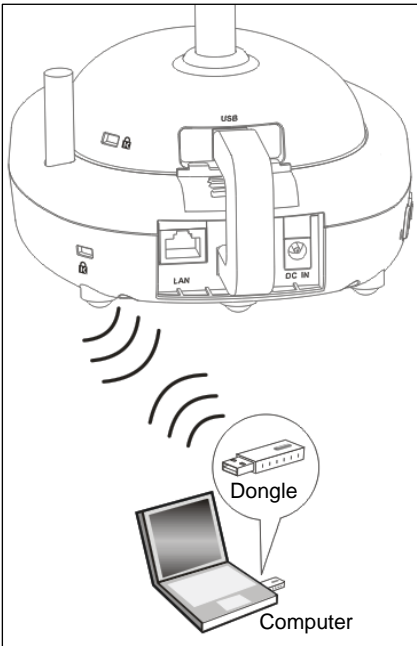

4.4 Use a network cable to connect to a computer

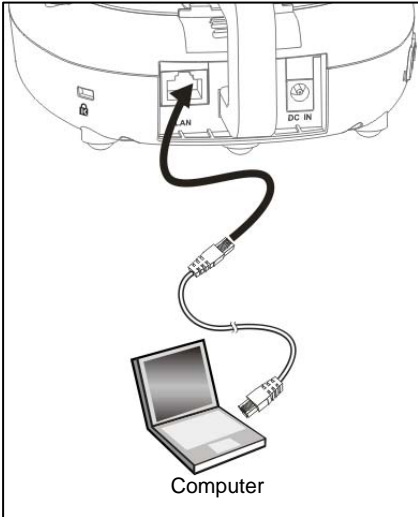

4.5 Installing application software

4.5.1 System requirements

Windows XP	Windows Vista / Windows 7
<ul style="list-style-type: none">● CPU: P4 2.8 GHz and above● Memory: 512MB● Support DirectX 9● Resolution: 1024x768● 100MB Free Hard-disk Space● Windows XP SP2 and above	<ul style="list-style-type: none">● CPU: P4 2.8 Ghz and above● Memory: 1GB (32-bits) / 2GB (64-bits)● DirectX 9 Compatible● Resolution: 1024x768● 100MB Free Hard-disk Space

4.5.2 Installing Ladibug™

[Note: Please be sure to install the Ladibug™ from the DC-A11 CD.]

4.5.2.1 Insert the software CD into your computer.

4.5.2.2 The software installation program will automatically launch. Please select [**Install Ladibug**] to begin installation.

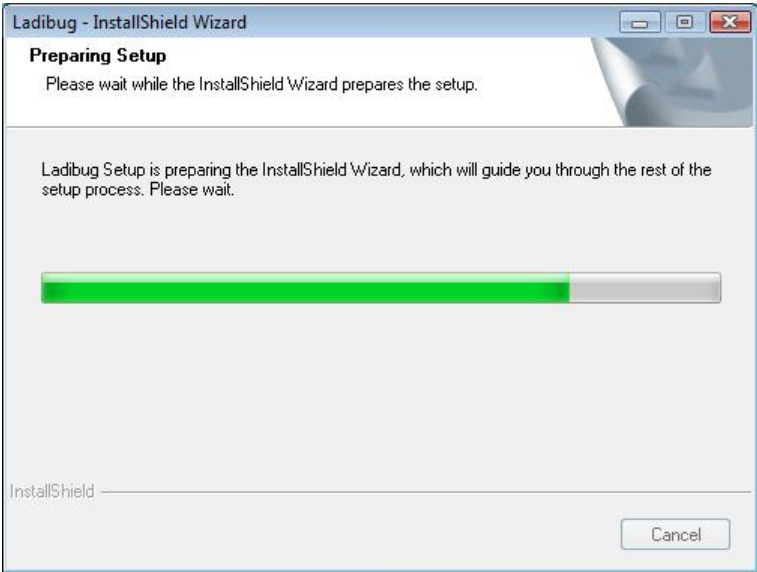

4.5.2.3 Please follow the instructions, then press [**Next**].

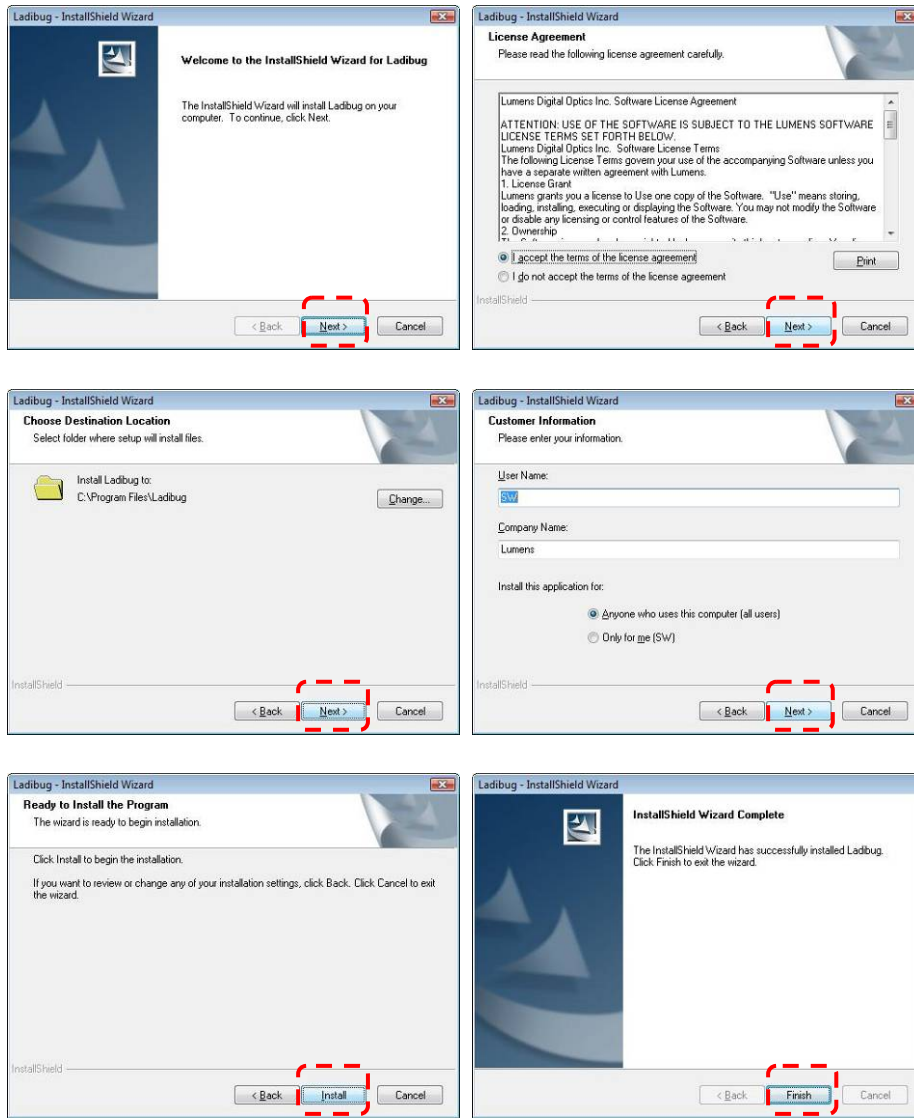

4.5.2.4 Press [**Yes**] to create a Ladibug™ shortcut on your desktop.

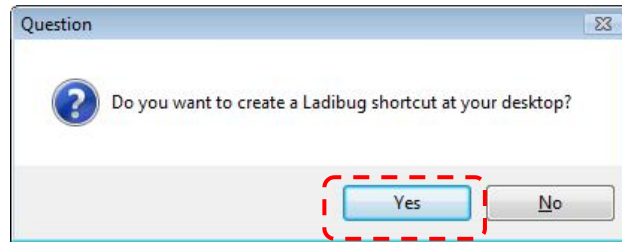

4.5.2.5 Continue to install the [**Lumens Wireless DC1**] .

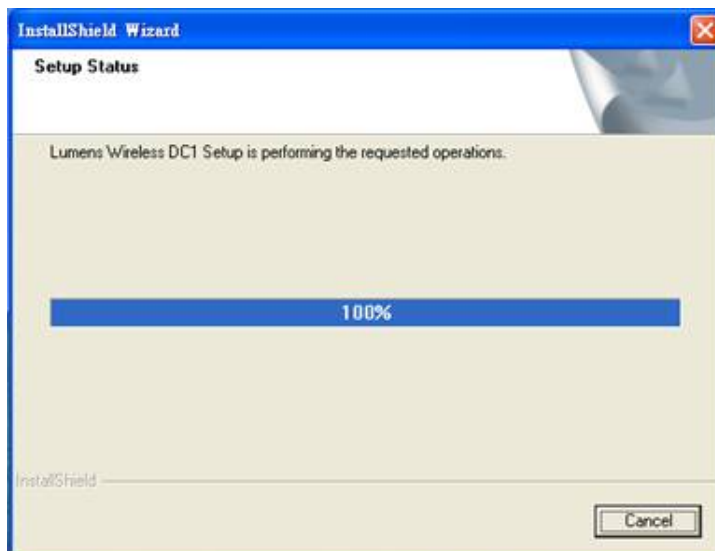
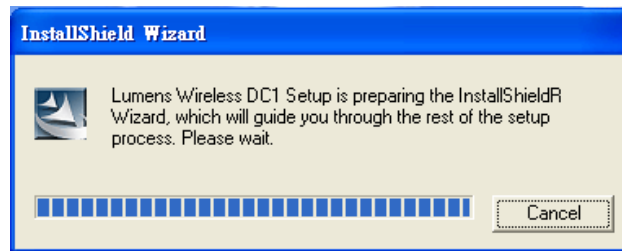

4.5.2.6 Click [**NO**], then press [**Finish**] to cancel the restart.

[NOTE: Please restart the computer only when the installation of Wireless LAN Utility is completed.]

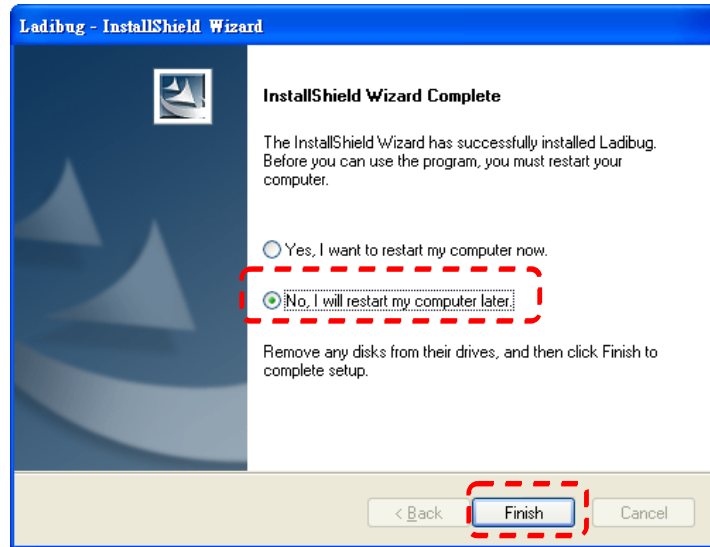

4.5.3 Installing Wireless LAN Utility

[NOTE] This utility doesn't support MAC OS.

4.5.3.1 Please select [**Wireless LAN Utility**] to begin installation.

4.5.3.2 Select Language.

4.5.3.3 Please follow the instructions, then press [**Next**].

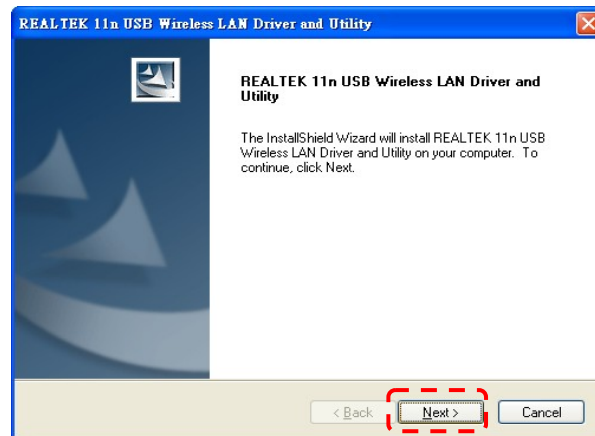

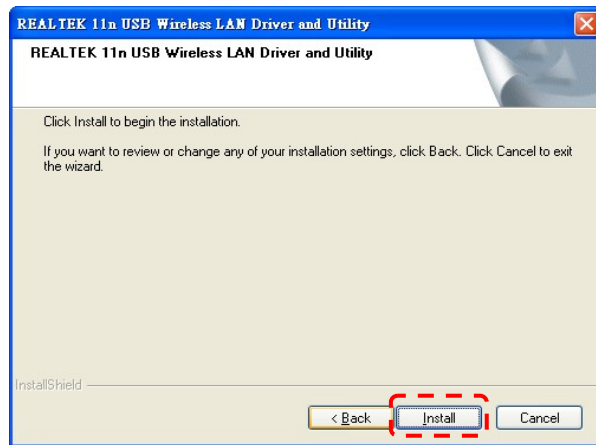

4.5.3.4 Please click the [**Finish**] button to restart your computer.

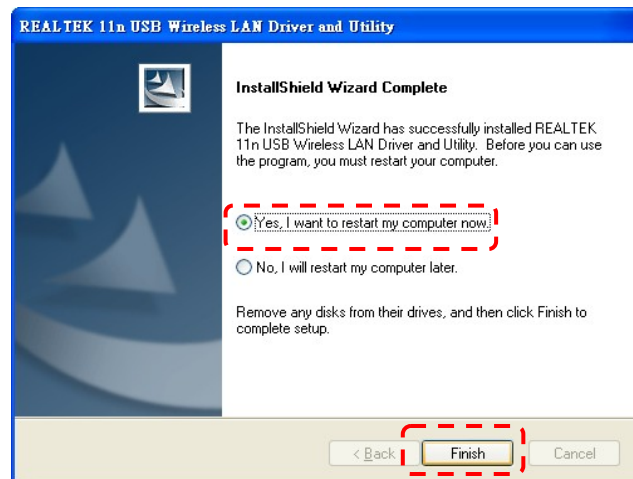

4.5.3.5 Setup the utility

4.5.3.5.1 Auto connection

- a. Power on.
- b. Press the WPS buttons on DC-A11 and the Dongle. (Whatever the order, but the action must be within 30 seconds.)

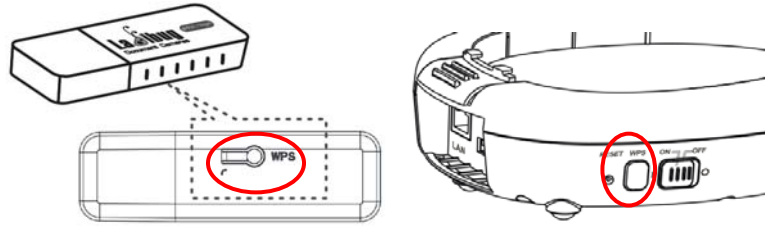

(Note: If the WPS button on the wireless Dongle cannot be used, open the Wireless LAN Utility and go to the [Wi-Fi Protected Setup] page. Click [Push Button Config] to enable the WPS connection.)

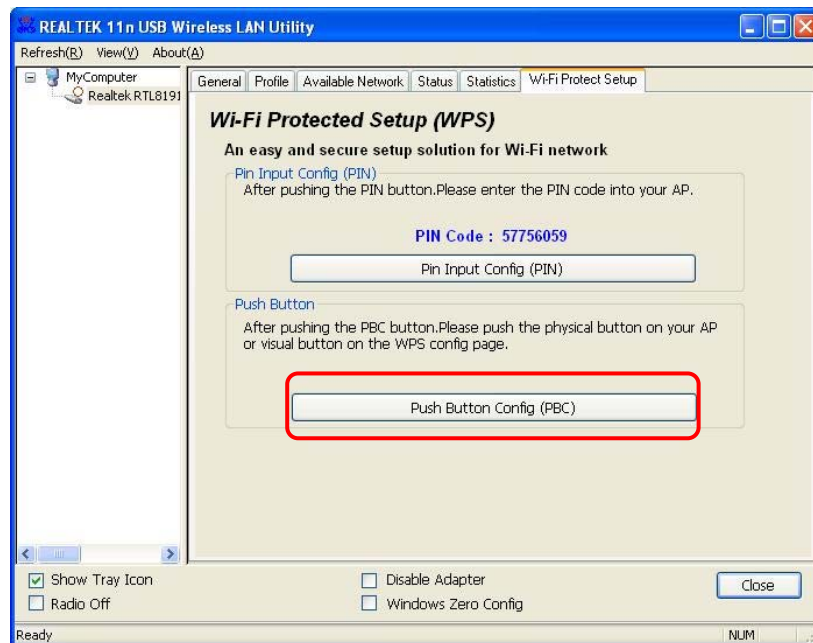

- c. The connection will start when the following window pops up. The connection will complete when the window closes.

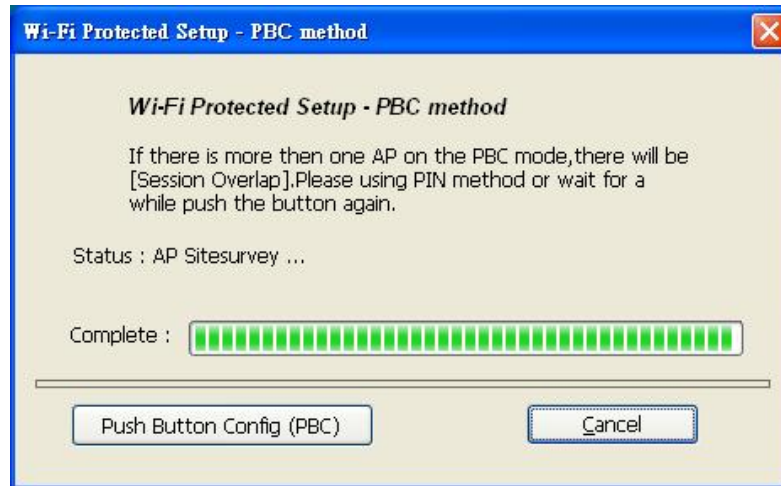

- d. Double click the icon  of Wireless LAN Utility.

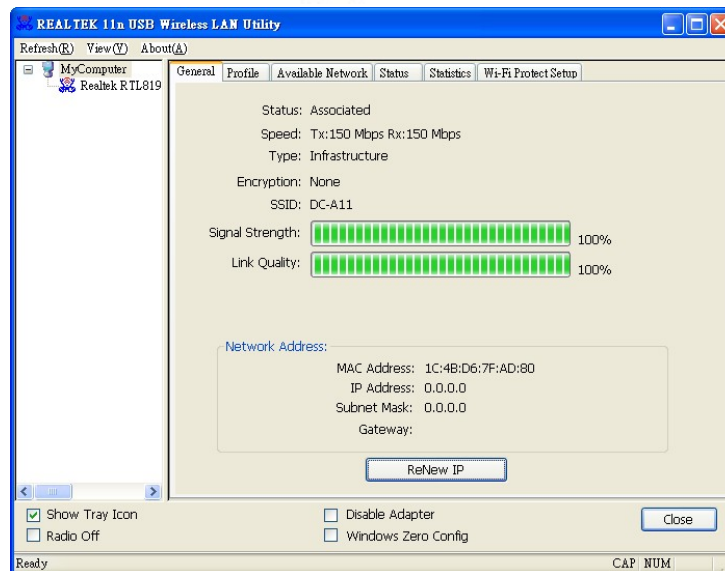

4.5.3.5.2 Manual connection



a. Double click the icon of Wireless LAN Utility.

b. Select [Available Network] tab, double click [DC-A11] (Default).

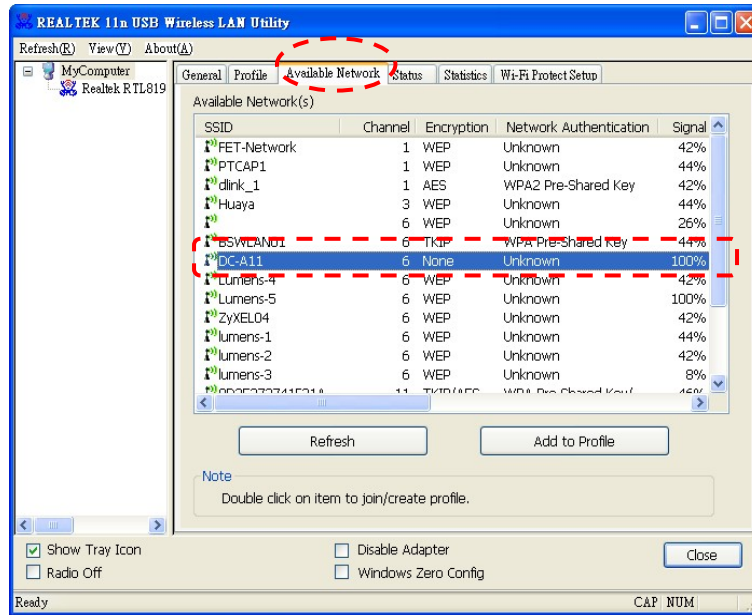

c. Click [OK]. (Remark: This step may not show up due to different OS.)



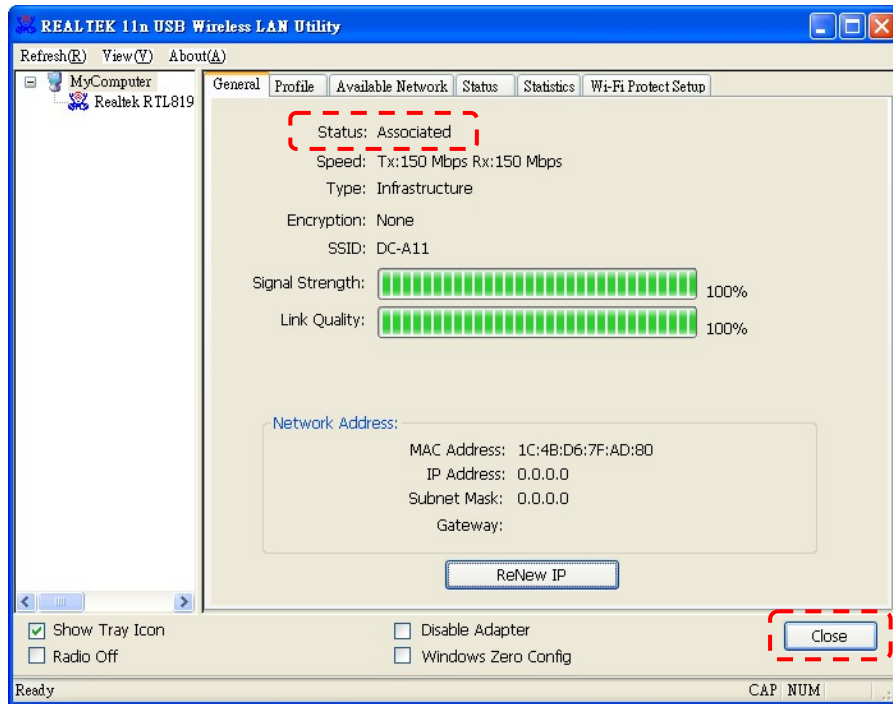

d. The connection is activated if the status is [Associated]. Please click [Close] to exit.

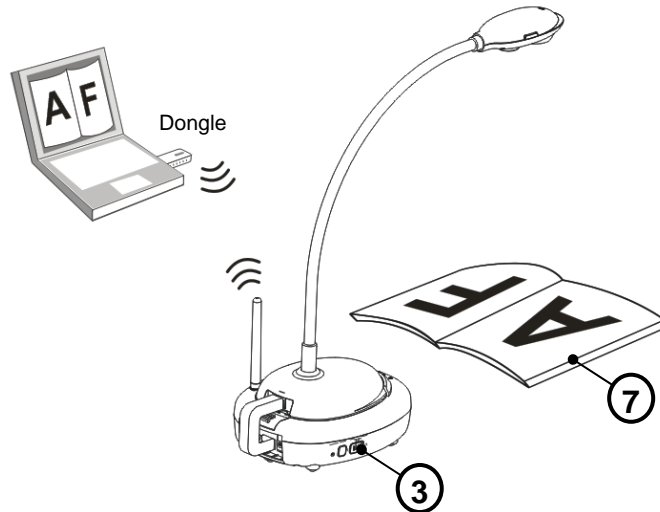

Chapter 5 Start Using



1. Charge unit for 3 hours.
2. Please make sure you have installed Ladibug™ and Wireless LAN Utility. Please refer to **4.5 Installing application software**
3. Switch the Power to [ON].
4. Select the DC-A11 wireless network by using Dongle or internal wireless connection.
5. Double click on  icon to activate Ladibug™ software.
6. Move the cursor to  icon, and the main function menu will be displayed.



7. Place an object to be displayed under the camera.
8. Click  button to optimize the image.

Chapter 6 Function Menu

6.1 General

After starting the utility, the general page pops up. The [**General**] tab provides the information of your current wireless network connection. You may click the [**Renew IP**] button to refresh the information.

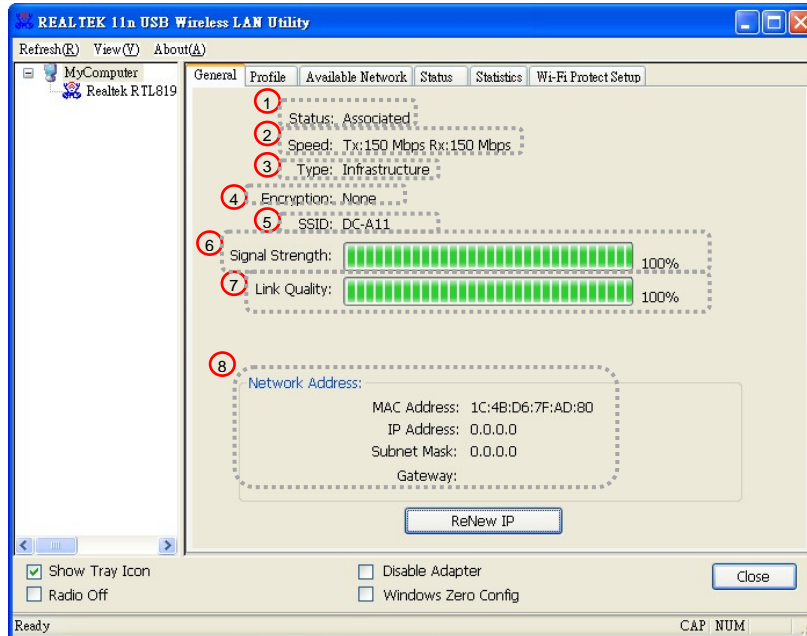

NO		Functions
1	Status	Check if the device is connected to target network.
2	Speed	The current connection speed.
3	Type	Infrastructure or Ad-Hoc mode.
4	Encryption	The encryption mode for connecting to current network profile.
5	SSID	The SSID (network name) of the connected wireless network
6	Signal Strength	Indicates the signal strength.
7	Link Quality	Indicates the quality of connection.
8	Network Address	Shows the current IP address settings.

6.2 Profile

The [**Profile**] tab lists the preferred connections. You can click the buttons beside to configure each connection.

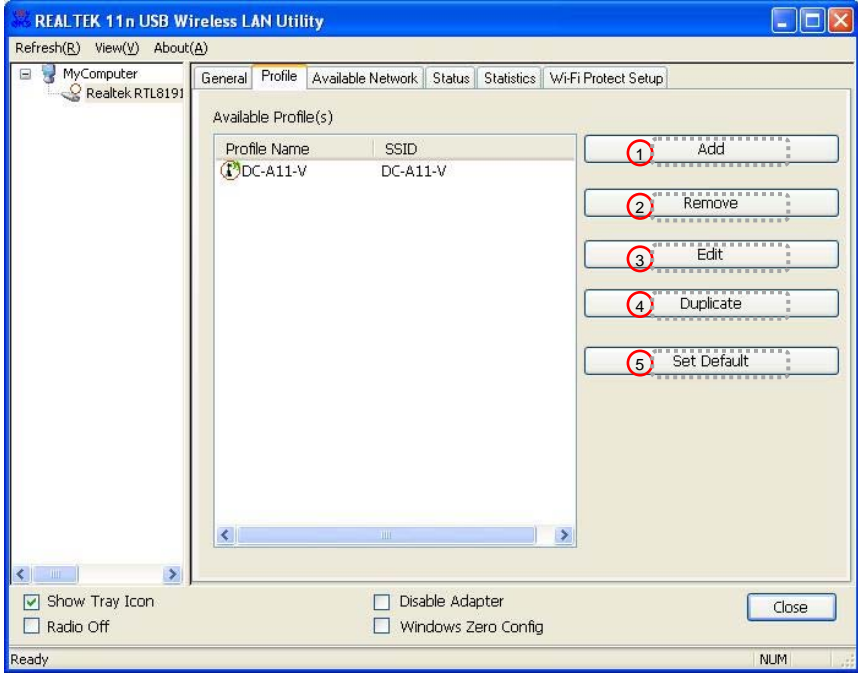

NO		Functions
1	Add	To add a connection profile.
2	Remove	To remove a connection profile.
3	Edit	To modify the configurations for a profile.
4	Duplicate	To make a copy of a profile.
5	Set Default	To select a profile as your default wireless connection.

6.3 Available Network

The [**Available Network**] tab lists the reachable wireless network.

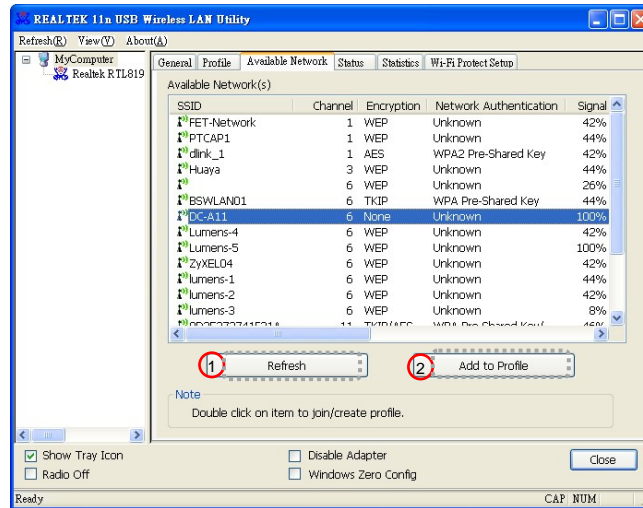

NO		Functions
1	Refresh	To rescan available Wireless Networks.
2	Add to Profile	To add an available Wireless Networks to your profile list.

6.4 Status

The [**Status**] tab shows the current connection status.

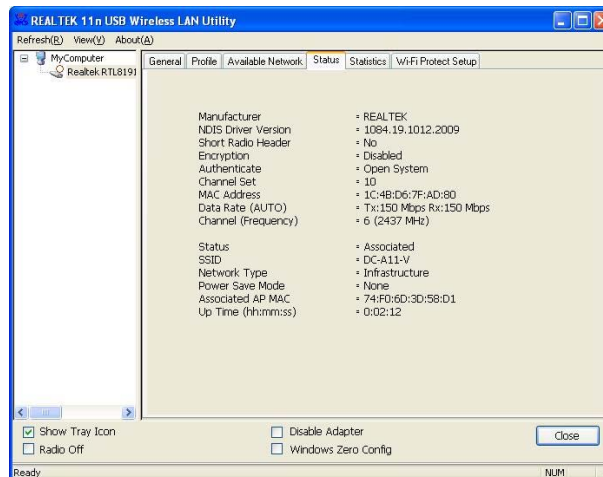

6.5 Statistics

The [**Statistics**] tab shows the transmission activity record. Clicking the [**Reset**] button recounts the values from zero.

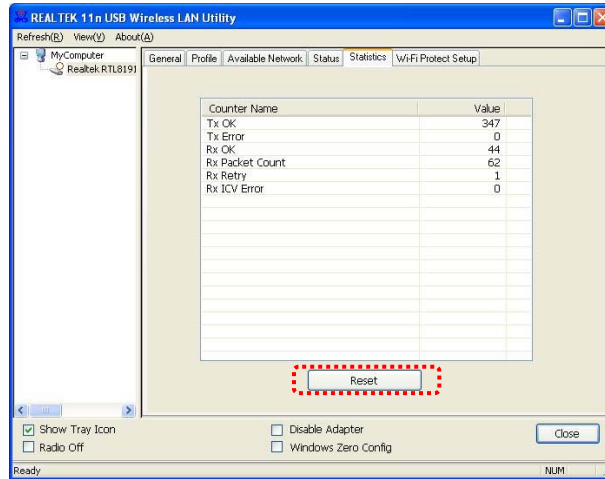

6.6 Wi-Fi Protected Setup (WPS)

An easy and secure setup solution for Wi-Fi network.

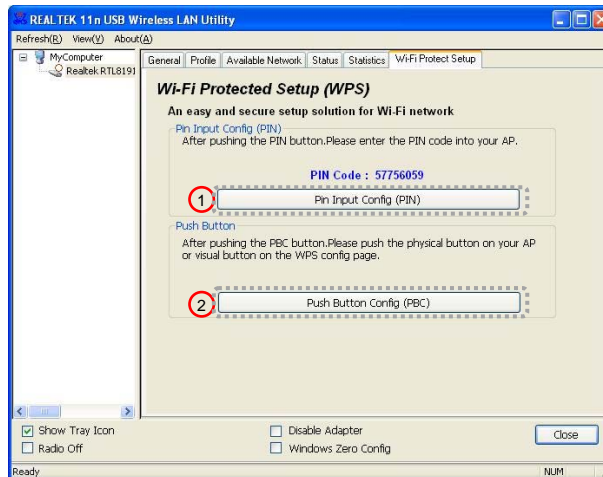

NO		Functions
1	Pin Input Config	Choose your AP for PIN Code connection.
2	Push Button Config	Search for available network connection. [Note] Please also push the WPS button on DC-A11 for connection.

Chapter 7 Descriptions of Major Functions

7.1 I would like to configure DC-A11 connection settings on the Internet

- 7.1.1 Open the Internet Explorer webpage browser, and enter [192.168.2.1] in the address bar.
- 7.1.2 Enter the Login Name [Admin].
- 7.1.3 Enter the Password ([Admin] by default), and click the [Login] button.

[Note] Close the Ladibug™ before you modify any settings.

7.2 I would like to change the login password

- 7.2.1 Click the [Admin] button to enter the [Admin] page.
- 7.2.2 Enter the new password in the [New Password] field.
- 7.2.3 Re-enter the password in the [Retype Password] field for verification.
- 7.2.4 Click [Apply]

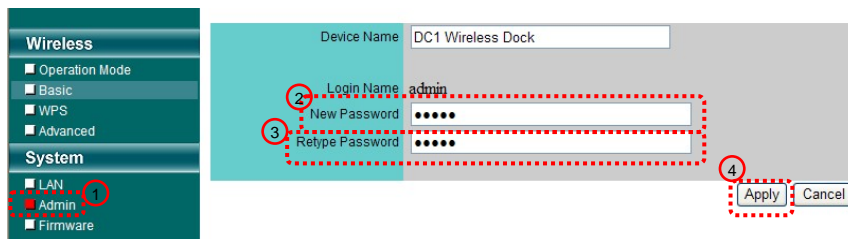

7.3 I would like to change the SSID and Channel

- 7.3.1 Click the [Basic] button to enter the [Basic] page.
[SSID] : (the public name of a wireless network): Set and change the name of the wireless network to be displayed.
[Channel] : The channel is [Channel 06] by default. Please choose your own channel frequency.
[Encryption Type] : Choose your encryption type.
- 7.3.2 Click [Apply]

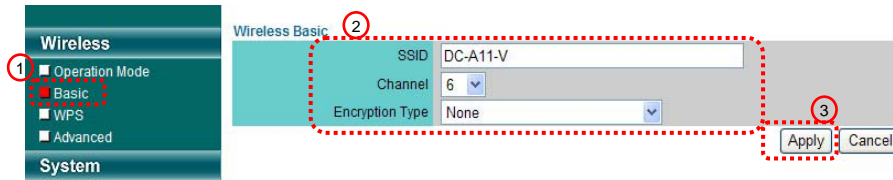

7.4 I would like to check the WPS connection settings

7.4.1 Click the [**WPS**] button to enter the [WPS] page.

7.4.2 The default setting is [Enabled]. If you want to modify the settings, please select [Disable].

7.4.3 Click [**Apply**]

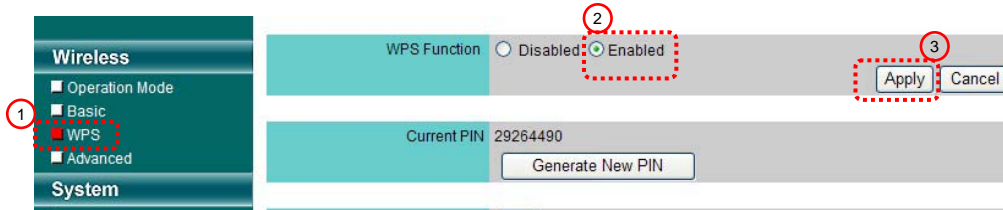

7.5 I would like to update the firmware

7.5.1 Please visit Lumens website: <http://www.lumens.com.tw/goto.htm> to download the updated firmware file.

7.5.2 Click the [**Firmware**] button to enter the [Firmware] page.

7.5.3 Click [**Browse**] to load the update file that you've just downloaded.

7.5.4 Click [**Upgrade**].

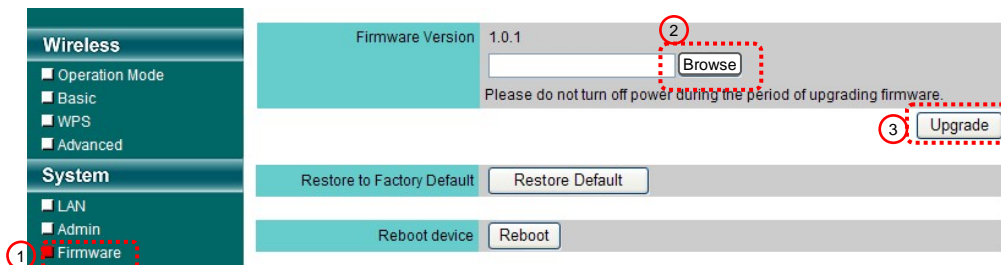

Chapter 8 LED Light Indicators

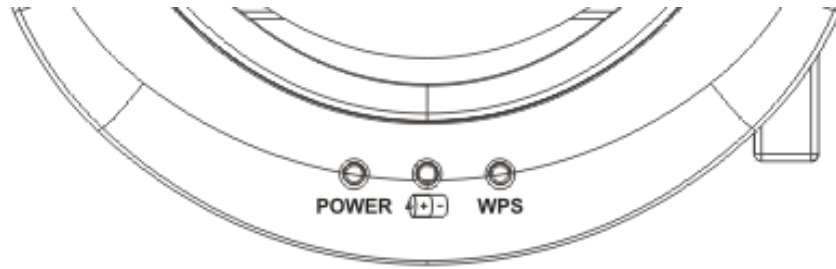

8.1 POWER : The battery indicator lights blue.

8.2 Battery  :

8.2.1 Light Off : No Power

8.2.2 Blue : Full Power

8.2.3 Red : Low power

8.2.4 Flashing Blue Light : In Charge

8.3 WPS :

8.3.1 Flashing Red Light : Detecting connection

8.3.2 Blue Light : Connection established

Chapter 9 Troubleshooting

This chapter describes problems you may encounter while using DC-A11. If you have questions, please refer to related chapters and follow all the suggested solutions. If the problem still occurred, please contact our distributors or service center.

No.	Problems	Solutions
1	LED indicator light OFF after DC-A11 is powered on	Please make sure DC-A11 has enough battery power (the battery indicator lights blue). If the battery indicator lights red, please connect the power cord to charge the device.
2	DC-A11 network is connected but malfunctions.	<ol style="list-style-type: none">1. Please confirm that the adapter is plugged into the USB port.2. Please restart network connection of DC-A11 and make sure that the USB connection between DC-A11 and DC120 is enabled. Then start the Ladibug™ software.
3	Password missing. Failure to login the admin page.	Please hold the [Reset] button on DC-A11 for 5 seconds to reset all configurations to factory default setting.
4	Automatic connection failed.	<ol style="list-style-type: none">1. Check the WPS settings. Please refer to 7.4 I would like to check the WPS connection setting2. If the device still fails to connect to the network automatically, please follow manual connection steps by referring to 4.5.3.5.2 Manual Connection.
5	The screen cannot be refreshed, and shows black screen	<ol style="list-style-type: none">1. This issue occurs when you unplug the Dongle directly while using the Ladibug™.2. Please close the Ladibug™, and then unplug the Dongle.
6	The computer	<ol style="list-style-type: none">1. Please close the Ladibug™, and then modify

	crashes after you have modified any settings	the settings.
7	DC-A11 network connection failed.	<ol style="list-style-type: none"> 1. Please fully extend DC-A11's antenna for better reception quality. 2. Please make sure that there's no obstacle between the DC-A11 and the wireless Dongle that interferes with signals. Keep a proper distance for wireless connection in place for better reception quality. 3. Please use the wireless Dongle in a ventilated place so as to prevent it from malfunctioning caused by overheating. 4. Make sure that DC-A11 network connection is correctly configured. Please refer to <u>4.5.3.5 Setup the utility</u>. 5. Use of two or more DC-A11 devices in the same place might interfere the wireless signals. It is advised to change the frequency channel of either one DC-A11 device to a different one in order to avoid signal interference. Please refer to <u>7.3 I would like to change the SSID and Channel</u>.