

rocketTM
TITANIUM

Carrier Class
airMAXTM BaseStation

Models: RM2-Ti, RM5-Ti

QUICK START GUIDE

Introduction

Thank you for purchasing the Ubiquiti Networks Rocket™ M Titanium. This Quick Start Guide is designed to walk you through the hardware installation and explains how to access the airOS™ Configuration Interface. This guide applies to the following models:

Model	Operating Frequency
RocketM2 Titanium (RM2-Ti)	2412 - 2462 MHz
RocketM5 Titanium (RM5-Ti)	5170 - 5875 MHz*

* Only 5725 - 5850 MHz supported in the USA
(US units with FCC ID: SWX-RM5T-DFS are allowed 5250 - 5825 MHz.)

Package Contents



RocketM Titanium



Quick Start
Guide



Gigabit PoE Adapter
(48V, 0.5A)



Power Cord



Metal Strap



GPS Patch Antenna
(only included with RM5-Ti)

Installation Requirements

- GPS antenna (RM5-Ti only) needs to have a clear line of sight to the sky.
- Shielded Category 5 (or above) cabling should be used for all wired Ethernet connections and should be grounded through the AC ground of the PoE.

We recommend that you protect your networks from the most brutal environments and devastating ESD attacks with industrial-grade shielded Ethernet cable from Ubiquiti Networks™. For more details, visit www.ubnt.com/toughcable

Hardware Overview

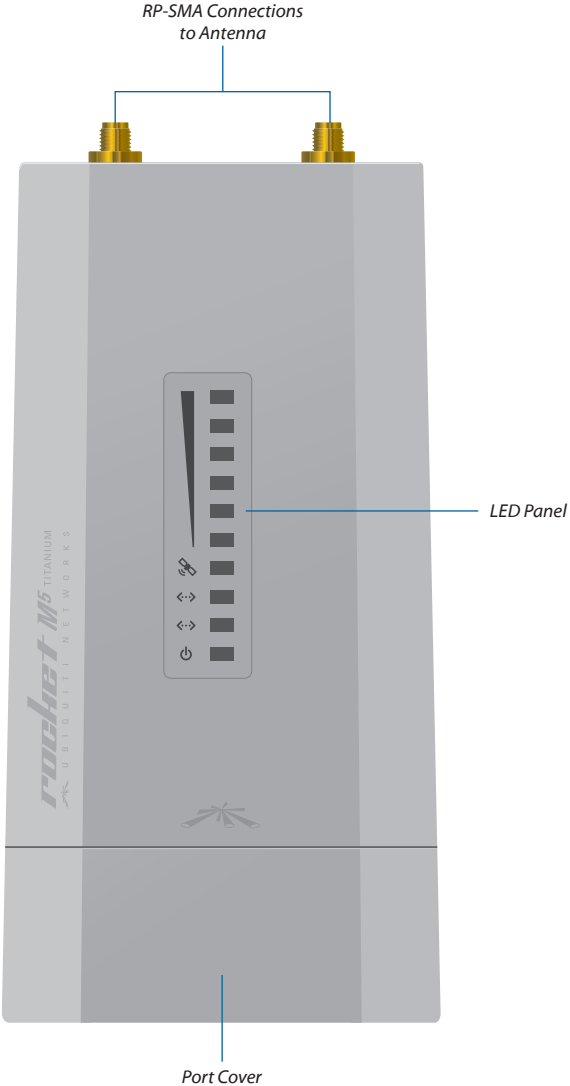

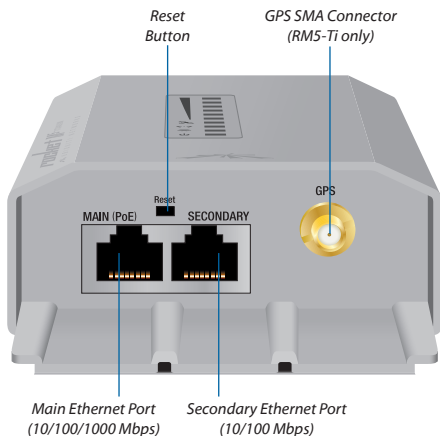

LED Panel



Signal LEDs The Signal LEDs display wireless signal strength. See *Using LEDs to Determine Signal Strength* on page 11.

GPS (RM5-Ti only) The GPS LED indicates airSync activity. Requires three or more satellite connections.

SECONDARY Ethernet The second Ethernet LED is steady green when an active Ethernet connection is made to the *Secondary Ethernet* port.

MAIN Ethernet The first Ethernet LED is steady green when an active Ethernet connection is made to the *Main Ethernet* port and flashes when there is activity.

POWER The Power LED is steady green when PoE power is connected to the *Main Ethernet* port.

Hardware Installation

The RocketM Titanium is designed to mount directly onto Ubiquiti airMAX RocketDish™ or Titanium Sector antennas. It can also be mounted directly on a pole.

1. Press the release buttons on the sides of the *Port Cover* and slide it off.

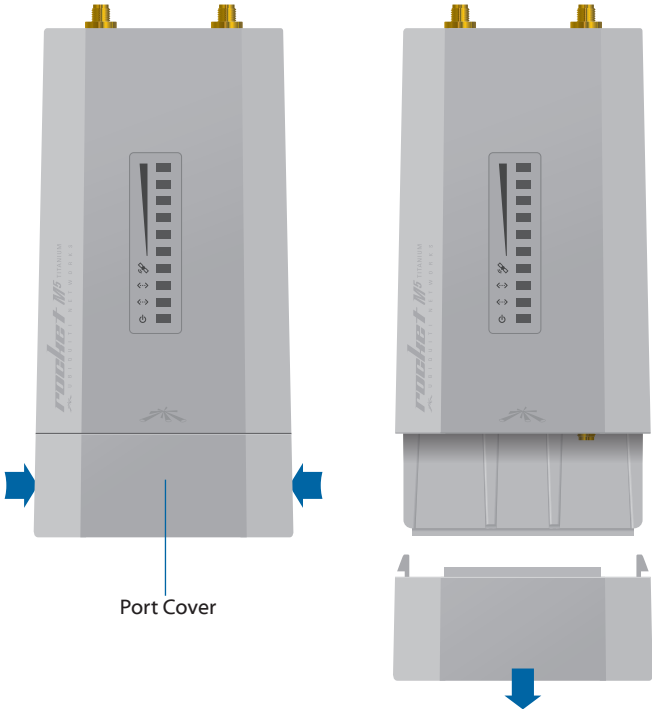

2. Connect an Ethernet cable to the *Main Ethernet* port.

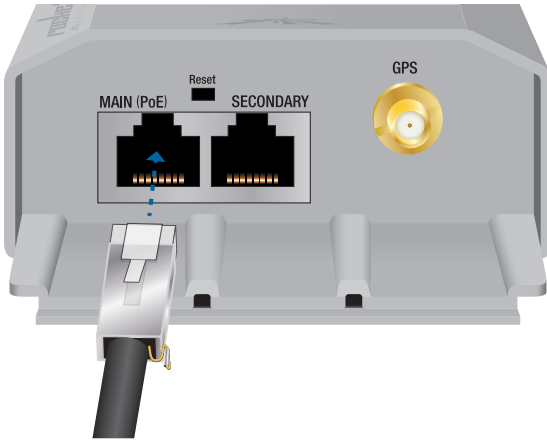

3. (RM5-Ti only) Connect the *GPS Patch Antenna* to the *GPS SMA Connector*.

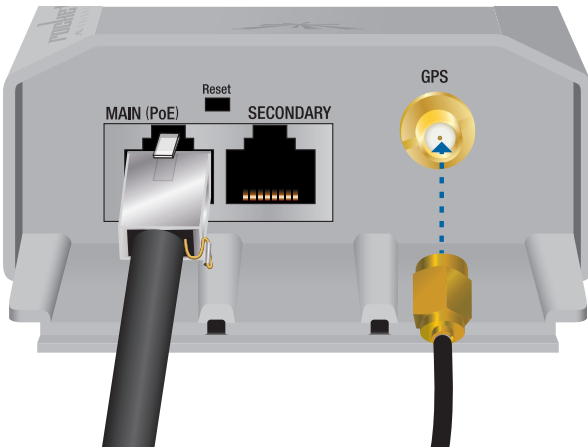

4. Replace the *Port Cover*.

5. Connect RF cables to the *RP-SMA Connectors* located on top of the RocketM Titanium.

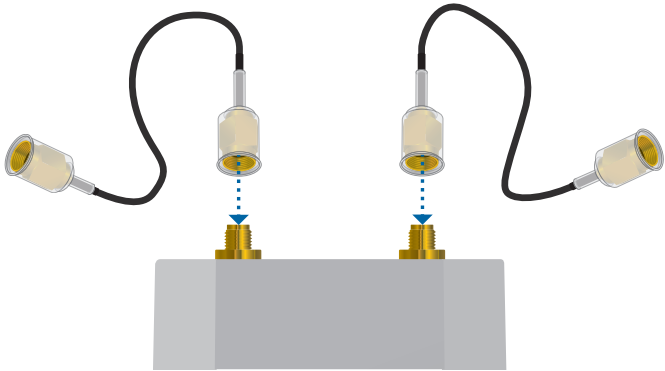

6. Attach the RocketM Titanium to an antenna. Align the mounting tabs on the back of the Rocket with the mounting bracket on the antenna. Slide the Rocket down until it locks into place.

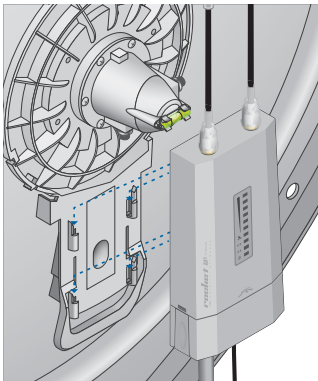

Mounting on a Dish Antenna

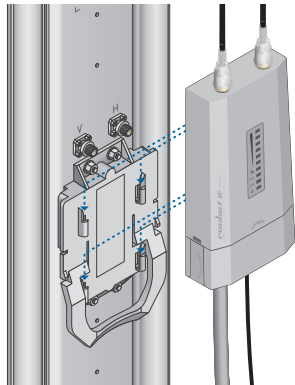

Mounting on a Sector Antenna

7. Attach the RF cables from the RocketM Titanium to the connectors on the antenna.

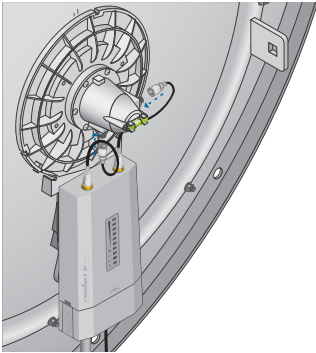

Connecting to a Dish Antenna

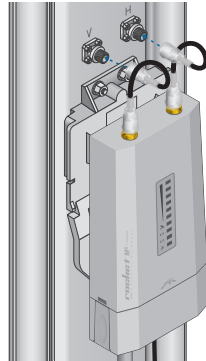

Connecting to a Sector Antenna

8. Attach the *Protective Shroud*.

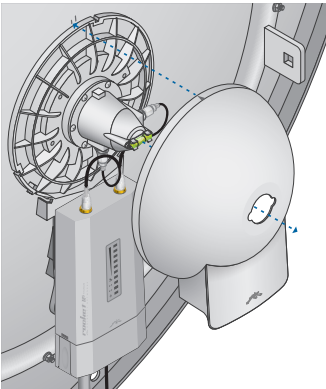

Align the arrow on the top of the shroud with the short hash mark on the Dish Antenna, and then rotate the shroud clockwise until it aligns with the long hash mark to lock it into place.

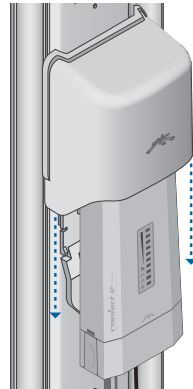

Slide the Protective Shroud down over the Rocket until it locks into place on the Sector Antenna.

9. (RM5-Ti only) Place the magnetic *GPS Patch Antenna* on the upper pole-mounting bracket.

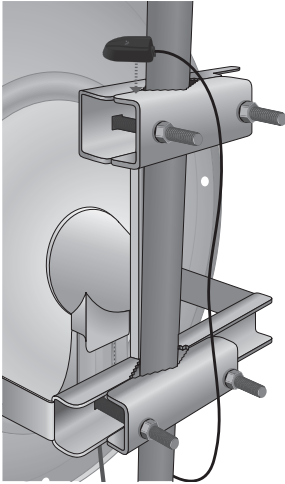

Placement on a Dish Antenna

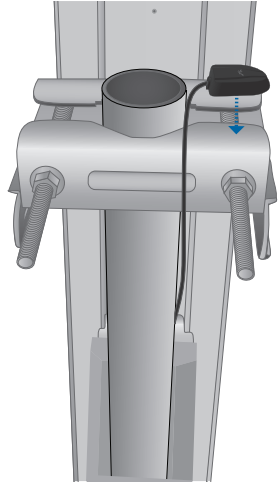

Placement on a Sector Antenna

Pole-Mounting

To mount the RocketM Titanium on a pole, use the included *Metal Strap* and perform the following steps:

1. Open the *Metal Strap* by turning the locking mechanism counter-clockwise. You can loosen it by hand or use a flathead screwdriver.

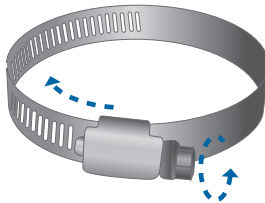

2. Straighten out the end of the *Metal Strap* and slide it through the back of the RocketM Titanium.

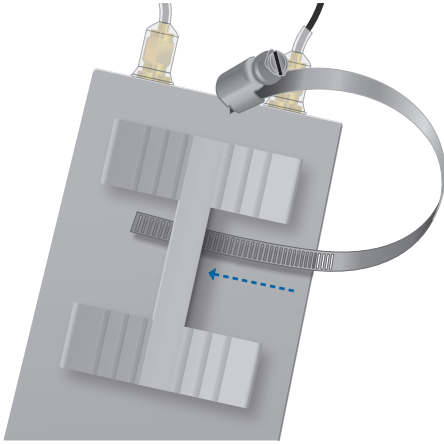

3. Wrap the *Metal Strap* around the pole and use a flathead screwdriver to tighten the locking mechanism by turning it clockwise.



Connecting Power over Ethernet

1. Connect the other end of the Ethernet cable from the RocketM Titanium to the Ethernet port labeled **POE** on the *PoE Adapter*.



2. Connect an Ethernet cable from your LAN to the Ethernet port labeled **LAN** on the *PoE Adapter*.



3. Connect the *Power Cord* to the power port on the *PoE Adapter*. Connect the other end of the *Power Cord* to a power outlet.



Using LEDs to Determine Signal Strength

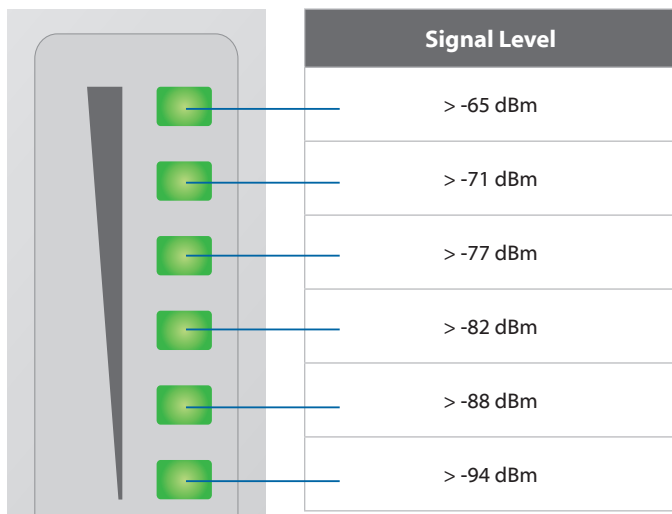

Note: By default, the Signal LEDs represent the wireless signal strength with the threshold values described above. In airOS, you can modify the threshold values for each LED or configure the LEDs to display the GPS connection quality instead. The settings can be configured on the *Advanced* tab under *Signal LED Thresholds*.

Accessing airOS™

Connect to the airOS Configuration Interface.

1. Make sure that your host machine is connected via Ethernet to the RocketM Titanium.
2. Configure the Ethernet adapter on your host system with a static IP address on the 192.168.1.x subnet.
3. Launch your web browser. Type **http://192.168.1.20** in the address field. Press **enter** (PC) or **return** (Mac).



4. The login screen will appear. Enter **ubnt** in the *Username* and *Password* fields. Select your *Country* and *Language*. You must agree to the *Terms of Use* to use the product. Click **Login**.



Note: U.S. product versions are locked to the U.S. Country Code to ensure compliance with FCC regulations.

A screenshot of the airOS login interface. The top left shows the "airOS™" logo. On the right, there are input fields for "Username" (containing "ubnt"), "Password" (masked with "****"), "Country" (set to "United States"), and "Language" (set to "English"). Below these fields is a "Login" button. On the left side, under the heading "TERMS OF USE", there is a paragraph of text and a checkbox labeled "I agree to these terms of use" which is checked.

5. The airOS Configuration Interface will appear, allowing you to customize your settings as needed.

6. (RM5-Ti only) On the *Main* tab you can verify the *GPS Signal Quality*. Click the **GPS Details** link under *Monitor* to view the Satellite and Signal details.

The screenshot shows the airOS web interface with the following details:

- Device Name:** UBNT
- Network Mode:** Bridge
- Wireless Mode:** Station
- SSID:** ubnt
- Security:** none
- Version:** [redacted]
- Uptime:** 00:38:19
- Date:** 2011-06-03 20:00:15
- Channel/Frequency:** 165 / 5825 MHz
- Channel Width:** Auto 20 / 40 MHz
- ACK Distance:** 27 / 0.1 miles (0.2 km)
- TX/RX Chains:** 2X2
- WLAN0 MAC:** 00:27:22:04:35:C3
- LAN0 MAC:** 00:27:22:08:35:C3
- LAN/LAN1:** 100Mbps-Full / Unplugged
- AP MAC:** Not Associated
- Signal Strength:** -
- Chain 0 / Chain 1:** 0 / 0 dBm
- Noise Floor:** -
- Transmit CCK:** -
- TX/RX Rate:** - / -
- AirMax:** -
- GPS Signal Quality:** 90% (indicated by a bar chart)
- Latitude / Longitude:** 33.78743 / -117.86277
- Altitude:** 20 m

The **Monitor** section includes links for Throughput, AP Information, ARP Table, Bridge Table, Routes, **GPS Details**, and Log. The **GPS Details** link is highlighted with a blue box and a blue arrow pointing to the text "GPS Details link" below the screenshot.

GPS Details link

airSync™ Capabilities (RM5-Ti only)

airSync resolves co-location interference issues. Many situations require the use of multiple airMAX M series devices on the same tower. Here are a couple of examples:

- To service a new area, add an airMAX basestation on an existing tower.
- To increase the capacity of an existing network, use multiple basestations with narrow coverage areas instead of one basestation with a wide coverage area.

Interference can be caused by the following:

- Devices using the same RF band (for example, 5 or 2.4 GHz) can be configured with different frequencies yet still interfere with each other if the frequency ranges are too closely spaced together (20 MHz separation is recommended between frequency band edges).
- Some RF bands, such as 900 MHz and 3.65 GHz, have only one 20 MHz channel, requiring all the basestations to use the same frequency range.

Interference will cause Receive (RX) errors on the basestation when it receives packets from associated stations that are typically miles away.

With airSync, the basestations make use of a common clock source using the built-in GPS receiver. One device is configured as the synchronization master and the others are configured in *Slave Mode* and provided with the MAC address of the *Master*.

Once this is done, the *Master* and *Slave* devices synchronize their transmit and receive cycles so that they transmit at the same time and receive at the same time. This resolves the interference issues.

Enabling Master/Slave Mode

1. Launch your web browser and log in to the airOS Configuration Interface (see page 12 for login details).
2. Click the Ubiquiti  tab.

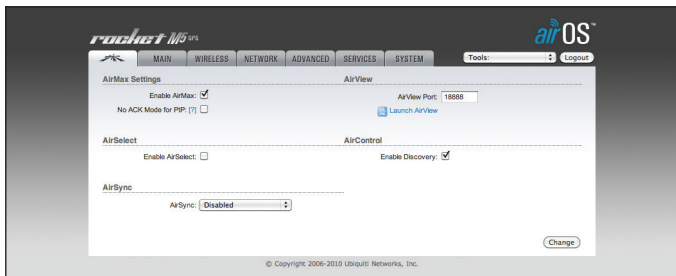

3. Select the appropriate mode:
 - **Master Mode** (synchronization master device)
 - **Slave Mode** (slave devices)



Note: Enter the MAC address of the Master in the *Sync Master* field.

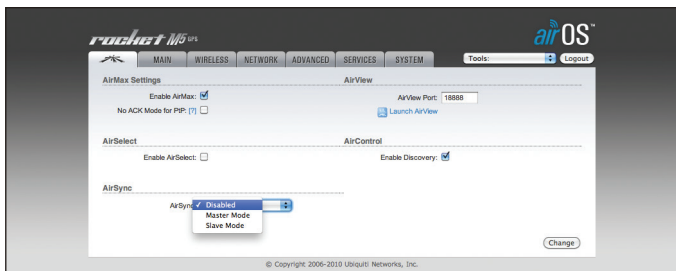

4. Click **Change** to save.

Installer Compliance Responsibility

Devices must be professionally installed and it is the professional installer's responsibility to make sure the device is operated within local country regulatory requirements.

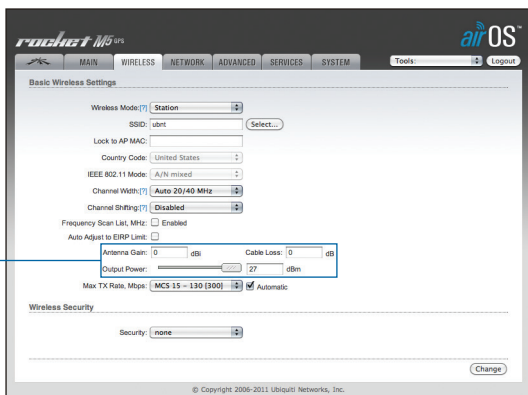

Since Ubiquiti Networks equipment can be paired with a variety of antennas and cables, the *Antenna Gain*, *Cable Loss*, and *Output Power* fields are provided to the professional installer to assist in meeting regulatory requirements.

Specifications

RocketM Titanium	
Dimensions	160 x 80 x 44 mm
Weight	350 g
Networking Interface	(1) 10/100/1000 Ethernet Port (Main) (1) 10/100 Ethernet Port (Secondary)
RF Connectors	
RM2-Ti	2 RP-SMA (Waterproof)
RM5-Ti	2 RP-SMA (Waterproof), 1 SMA (GPS)
Enclosure	Die-Cast Aluminum
Max. Power Consumption	
RM2-Ti	6.5 W
RM5-Ti	8 W
Power Supply	48V, 0.5A PoE Adapter (Included)
Power Method	Passive PoE (Pairs 4, 5+; 7,8 Return)
Operating Temperature	-30 to 75° C (-22 to 167° F)
Operating Humidity	5 to 95% Condensing
ESD/EMP Protection	30KV Contact / Air for Ethernet
Shock and Vibrations	ETSI300-019-1.4
Certifications	CE, FCC, IC
Operating Frequency	
RM2-Ti	2412 - 2462 MHz
RM5-Ti	5170 - 5875 MHz*

* Only 5725 - 5850 MHz supported in the USA
(US units with FCC ID: SWX-RM5T-DFS are allowed 5250 - 5825 MHz.)

Safety Notices

1. Read, follow, and keep these instructions.
2. Heed all warnings.
3. Only use attachments/accessories specified by the manufacturer.



WARNING: Do not use this product in location that can be submerged by water.



WARNING: Avoid using this product during an electrical storm. There may be a remote risk of electric shock from lightning.

Electrical Safety Information

1. Compliance is required with respect to voltage, frequency, and current requirements indicated on the manufacturer's label. Connection to a different power source than those specified may result in improper operation, damage to the equipment or pose a fire hazard if the limitations are not followed.
2. There are no operator serviceable parts inside this equipment. Service should be provided only by a qualified service technician.
3. This equipment is provided with a detachable power cord which has an integral safety ground wire intended for connection to a grounded safety outlet.
 - a. Do not substitute the power cord with one that is not the provided approved type. Never use an adapter plug to connect to a 2-wire outlet as this will defeat the continuity of the grounding wire.
 - b. The equipment requires the use of the ground wire as a part of the safety certification, modification or misuse can provide a shock hazard that can result in serious injury or death.
 - c. Contact a qualified electrician or the manufacturer if there are questions about the installation prior to connecting the equipment.
 - d. Protective earthing is provided by Listed AC adapter. Building installation shall provide appropriate short-circuit backup protection.
 - e. Protective bonding must be installed in accordance with local national wiring rules and regulations.

General Warranty

UBIQUITI NETWORKS, Inc (“UBIQUITI NETWORKS”) represents and warrants that the Products furnished hereunder shall be free from defects in material and workmanship for a period of one (1) year from the date of shipment by UBIQUITI NETWORKS under normal use and operation. UBIQUITI NETWORKS sole and exclusive obligation under the foregoing warranty shall be to repair or replace, at its option, any defective Product that fails during the warranty period. The expense of removal and reinstallation of any item is not included in this warranty.

The foregoing warranty is exclusive and in lieu of all other warranties, express or implied, including the implied warranties of merchantability and fitness for a particular purpose and any warranties arising from a course of dealing, usage or trade practice with respect to the products. Repair or replacement in the manner provided herein shall be the sole and exclusive remedy of Buyer for breach of warranty and shall constitute fulfillment of all liabilities of UBIQUITI NETWORKS with respect to the quality and performance of the Products. UBIQUITI NETWORKS reserves the right to inspect all defective Products (which must be returned by Buyer to UBIQUITI NETWORKS factory freight prepaid).

No Products will be accepted for replacement or repair without obtaining a Return Materials Authorization (RMA) number from UBIQUITI NETWORKS. Products returned without an RMA number will not be processed and will be returned to Buyer freight collect. UBIQUITI NETWORKS shall have no obligation to make repairs or replacement necessitated by catastrophe, fault, negligence, misuse, abuse, or accident by Buyer, Buyer’s customers or any other parties. The warranty period of any repaired or replaced Product shall not extend beyond its original term.

EXCEPT FOR ANY EXPRESS WARRANTIES PROVIDED HEREIN, UBIQUITI NETWORKS’ PRODUCTS AND SERVICES ARE PROVIDED “AS IS”, WITHOUT WARRANTY OR CONDITION OF ANY KIND, EITHER EXPRESS OR IMPLIED. UBIQUITI NETWORKS, ITS AFFILIATES, AND ITS AND THEIR THIRD PARTY DATA, SERVICE, SOFTWARE AND HARDWARE PROVIDERS HEREBY DISCLAIM AND MAKE NO OTHER REPRESENTATION OR WARRANTY OF ANY KIND, EXPRESS, IMPLIED OR STATUTORY, INCLUDING BUT NOT LIMITED TO REPRESENTATIONS, GUARANTEES, OR WARRANTIES OF MERCHANTABILITY, ACCURACY, QUALITY OF SERVICE OR RESULTS, AVAILABILITY, SATISFACTORY QUALITY, LACK OF VIRUSES, TITLE, QUIET ENJOYMENT, FITNESS FOR A PARTICULAR PURPOSE AND NON-INFRINGEMENT. BUYER ACKNOWLEDGE THAT NEITHER UBIQUITI NETWORKS NOR ITS THIRD PARTY PROVIDERS CONTROLS BUYER’S EQUIPMENT OR THE TRANSFER OF DATA OVER COMMUNICATIONS FACILITIES, INCLUDING THE INTERNET, AND THAT THE PRODUCTS AND SERVICES MAY BE SUBJECT TO LIMITATIONS, INTERRUPTIONS, DELAYS, CANCELLATIONS AND OTHER PROBLEMS INHERENT IN THE USE OF THE COMMUNICATIONS FACILITIES. UBIQUITI NETWORKS, ITS AFFILIATES AND ITS AND THEIR THIRD PARTY PROVIDERS ARE NOT RESPONSIBLE FOR ANY INTERRUPTIONS, DELAYS, CANCELLATIONS, DELIVERY FAILURES, DATA LOSS, CONTENT CORRUPTION, PACKET LOSS, OR OTHER DAMAGE RESULTING FROM THESE PROBLEMS.

Warranty Conditions

The foregoing warranty shall apply only if:

- (I) The Product has not been subjected to misuse, neglect or unusual physical, electrical or electromagnetic stress, or some other type of accident.
- (II) No modification, alteration or addition has been made to the Product by persons other than UBIQUITI NETWORKS or UBIQUITI NETWORK'S authorized representatives or otherwise approved by UBIQUITI NETWORKS.
- (III) The Product has been properly installed and used at all times in accordance, and in all material respects, with the applicable Product documentation.
- (IV) All Ethernet cabling runs use CAT5 (or above) shielded cabling.

Disclaimer: UBIQUITI NETWORKS does not warrant that the operation of the products is error-free or that operation will be uninterrupted. In no event shall UBIQUITI NETWORKS be responsible for damages or claims of any nature or description relating to system performance, including coverage, buyer's selection of products for buyer's application and/or failure of products to meet government or regulatory requirements.

Returns

In the unlikely event a defect occurs, please work through the dealer or distributor from which this product was purchased.

Compliance

FCC

Changes or modifications not expressly approved by the party responsible for compliance could void the user's authority to operate the equipment.

This device complies with Part 15 of the FCC Rules. Operation is subject to the following two conditions:

1. This device may not cause interference, and
2. This device must accept any interference, including interference that may cause undesired operation of the device.

NOTE: This equipment has been tested and found to comply with the limits for a Class A digital device, pursuant to part 15 of the FCC Rules. These limits are designed to provide reasonable protection against harmful interference when the equipment is operated in a commercial environment. This equipment generates, uses, and can radiate radio frequency energy and, if not installed and used in accordance with the instruction manual, may cause harmful interference to radio communications. Operations of this equipment in a residential area is likely to cause harmful interference in which case the user will be required to correct the interference at his own expense.

For MPE and antenna usage details, please visit our website at www.ubnt.com/products

Industry Canada

This Class A digital apparatus complies with Canadian ICES-003.

To reduce potential radio interference to other users, the antenna type and its gain should be so chosen that the equivalent isotropically radiated power (e.i.r.p.) is not more than that permitted for successful communication.

This device complies with Industry Canada licence-exempt RSS standard(s). Operation is subject to the following two conditions:

1. This device may not cause interference, and
2. This device must accept any interference, including interference that may cause undesired operation of the device.

Cet appareil numérique de la classe A est conforme à la norme NMB-003 Canada.

Pour réduire le risque d'interférence aux autres utilisateurs, le type d'antenne et son gain doivent être choisies de façon que la puissance isotrope rayonnée équivalente (PIRE) ne dépasse pas ce qui est nécessaire pour une communication réussie.

Cet appareil est conforme à la norme RSS Industrie Canada exempts de licence norme(s). Son fonctionnement est soumis aux deux conditions suivantes:

1. Cet appareil ne peut pas provoquer d'interférences et
2. Cet appareil doit accepter toute interférence, y compris les interférences qui peuvent causer un mauvais fonctionnement du dispositif.

RF Exposure Warning

The antennas used for this transmitter must be installed to provide a separation distance of at least 243 cm from all persons and must not be located or operating in conjunction with any other antenna or transmitter.

Les antennes utilisées pour ce transmetteur doivent être installées en considérant une distance de séparation de toute personnes d'au moins 243 cm et ne doivent pas être localisées ou utilisées en conflit avec tout autre antenne ou transmetteur.

CE Marking

CE marking on this product represents the product is in compliance with all directives that are applicable to it.

Alert Sign (!) Follows CE Marking

Alert sign must be indicated if a restriction on use applied to the product and it must follow the CE marking.



RoHS/WEEE Compliance Statement



English

European Directive 2002/96/EC requires that the equipment bearing this symbol on the product and/or its packaging must not be disposed of with unsorted municipal waste. The symbol indicates that this product should be disposed of separately from regular household waste streams. It is your responsibility to dispose of this and other electric and electronic equipment via designated collection facilities appointed by the government or local authorities. Correct disposal and recycling will help prevent potential negative consequences to the environment and human health. For more detailed information about the disposal of your old equipment, please contact your local authorities, waste disposal service, or the shop where you purchased the product.

Deutsch

Die Europäische Richtlinie 2002/96/EC verlangt, dass technische Ausrüstung, die direkt am Gerät und/oder an der Verpackung mit diesem Symbol versehen ist, nicht zusammen mit unsortiertem Gemeindeabfall entsorgt werden darf. Das Symbol weist darauf hin, dass das Produkt von regulärem Haushaltsmüll getrennt entsorgt werden sollte. Es liegt in Ihrer Verantwortung, dieses Gerät und andere elektrische und elektronische Geräte über die dafür zuständigen und von der Regierung oder örtlichen Behörden dazu bestimmten Sammelstellen zu entsorgen. Ordnungsgemäßes Entsorgen und Recyceln trägt dazu bei, potentielle negative Folgen für Umwelt und die menschliche Gesundheit zu vermeiden. Wenn Sie weitere Informationen zur Entsorgung Ihrer Altgeräte benötigen, wenden Sie sich bitte an die örtlichen Behörden oder städtischen Entsorgungsdienste oder an den Händler, bei dem Sie das Produkt erworben haben.

Español

La Directiva 2002/96/CE de la UE exige que los equipos que lleven este símbolo en el propio aparato y/o en su embalaje no deben eliminarse junto con otros residuos urbanos no seleccionados. El símbolo indica que el producto en cuestión debe separarse de los residuos domésticos convencionales con vistas a su eliminación. Es responsabilidad suya desechar este y cualesquiera otros aparatos eléctricos y electrónicos a través de los puntos de recogida que ponen a su disposición el gobierno y las autoridades locales. Al desechar y reciclar correctamente estos aparatos estará contribuyendo a evitar posibles consecuencias negativas para el medio ambiente y la salud de las personas. Si desea obtener información más detallada sobre la eliminación segura de su aparato usado, consulte a las autoridades locales, al servicio de recogida y eliminación de residuos de su zona o pregunte en la tienda donde adquirió el producto.

Français

La directive européenne 2002/96/CE exige que l'équipement sur lequel est apposé ce symbole sur le produit et/ou son emballage ne soit pas jeté avec les autres ordures ménagères. Ce symbole indique que le produit doit être éliminé dans un circuit distinct de celui pour les déchets des ménages. Il est de votre responsabilité de jeter ce matériel ainsi que tout autre matériel électrique ou électronique par les moyens de collecte indiqués par le gouvernement et les pouvoirs publics des collectivités territoriales. L'élimination et le recyclage en bonne et due forme ont pour but de lutter contre l'impact néfaste potentiel de ce type de produits sur l'environnement et la santé publique. Pour plus d'informations sur le mode d'élimination de votre ancien équipement, veuillez prendre contact avec les pouvoirs publics locaux, le service de traitement des déchets, ou l'endroit où vous avez acheté le produit.

Italiano

La direttiva europea 2002/96/EC richiede che le apparecchiature contrassegnate con questo simbolo sul prodotto e/o sull'imballaggio non siano smaltite insieme ai rifiuti urbani non differenziati. Il simbolo indica che questo prodotto non deve essere smaltito insieme ai normali rifiuti domestici. È responsabilità del proprietario smaltire sia questi prodotti sia le altre apparecchiature elettriche ed elettroniche mediante le specifiche strutture di raccolta indicate dal governo o dagli enti pubblici locali. Il corretto smaltimento ed il riciclaggio aiuteranno a prevenire conseguenze potenzialmente negative per l'ambiente e per la salute dell'essere umano. Per ricevere informazioni più dettagliate circa lo smaltimento delle vecchie apparecchiature in Vostro possesso, Vi invitiamo a contattare gli enti pubblici di competenza, il servizio di smaltimento rifiuti o il negozio nel quale avete acquistato il prodotto.

Declaration of Conformity

Česky [Czech]	UBIQUITI NETWORKS tímto prohlašuje, že tento UBIQUITI NETWORKS device, je ve shodě se základními požadavky a dále s ostatními ustanoveními směrnice 1999/5/ES.
Dansk [Danish]	Undertegnede UBIQUITI NETWORKS erklærer herved, at følgende udstyr UBIQUITI NETWORKS device, overholder de væsentlige krav og øvrige relevante krav i direktiv 1999/5/EF.
Nederlands [Dutch]	Hierbij verklaart UBIQUITI NETWORKS dat het toestel UBIQUITI NETWORKS device, in overeenstemming is met de essentiële eisen en de andere relevante bepalingen van richtlijn 1999/5/EG. Bij deze verklaart UBIQUITI NETWORKS dat deze UBIQUITI NETWORKS device, voldoet aan de essentiële eisen en aan de overige relevante bepalingen van Richtlijn 1999/5/EC.
English	Hereby, UBIQUITI NETWORKS, declares that this UBIQUITI NETWORKS device, is in compliance with the essential requirements and other relevant provisions of Directive 1999/5/EC.
Eesti [Estonian]	Käesolevaga kinnitab UBIQUITI NETWORKS seadme UBIQUITI NETWORKS device, vastavust direktiivi 1999/5/EÜ põhinõuetele ja nimetatud direktiivist tulenevatele teistele asjakohastele sätetele.
Suomi [Finnish]	UBIQUITI NETWORKS vakuuttaa täten että UBIQUITI NETWORKS device, tyypinen laite on direktiivin 1999/5/EY oleellisten vaatimusten ja sitä koskevien direktiivin muiden ehtojen mukainen.
Français [French]	Par la présente UBIQUITI NETWORKS déclare que l'appareil UBIQUITI NETWORKS device est conforme aux exigences essentielles et aux autres dispositions pertinentes de la directive 1999/5/CE. Par la présente, UBIQUITI NETWORKS déclare que ce UBIQUITI NETWORKS device, est conforme aux exigences essentielles et aux autres dispositions de la directive 1999/5/CE qui lui sont applicables.
Deutsch [German]	Hiermit erklärt UBIQUITI NETWORKS, dass sich diese UBIQUITI NETWORKS device, in Übereinstimmung mit den grundlegenden Anforderungen und den anderen relevanten Vorschriften der Richtlinie 1999/5/EG befindet". (BMWi) Hiermit erklärt UBIQUITI NETWORKS die Übereinstimmung des Gerätes UBIQUITI NETWORKS device, mit den grundlegenden Anforderungen und den anderen relevanten Festlegungen der Richtlinie 1999/5/EG. (Wien)
Ελληνική [Greek]	ΜΕ ΤΗΝ ΠΑΡΟΥΣΑ UBIQUITI NETWORKS ΔΗΛΩΝΕΙ ΟΤΙ UBIQUITI NETWORKS device, ΣΥΜΜΟΡΦΩΝΕΤΑΙ ΠΡΟΣ ΤΙΣ ΟΥΣΙΩΔΕΙΣ ΑΠΑΙΤΗΣΕΙΣ ΚΑΙ ΤΙΣ ΛΟΙΠΕΣ ΣΧΕΤΙΚΕΣ ΔΙΑΤΑΞΕΙΣ ΤΗΣ ΟΔΗΓΙΑΣ 1999/5/ΕΚ.
Magyar [Hungarian]	Alulírott, UBIQUITI NETWORKS nyilatkozom, hogy a UBIQUITI NETWORKS device, megfelel a vonatkozó alapvető követelményeknek és az 1999/5/EC irányelv egyéb előírásainak.

Íslenska [Icelandic]	Hér me l sir UBIQUITI NETWORKS yfir ví a UBIQUITI NETWORKS device, er í samræmi við grunnkröfur og a rar kröfur, sem ger ar eru í tilskipun 1999/5/EC.
Italiano [Italian]	Con la presente UBIQUITI NETWORKS dichiara che questo UBIQUITI NETWORKS device, è conforme ai requisiti essenziali ed alle altre disposizioni pertinenti stabilite dalla direttiva 1999/5/CE.
Latviski [Latvian]	Ar o UBIQUITI NETWORKS deklar , ka UBIQUITI NETWORKS device, atbilst Direkt vas 1999/5/EK b tiskaj m pras b m un citiem ar to saist tajiem noteikumiem.
Lietuviškai [Lithuanian]	UBIQUITI NETWORKS deklaruoja, kad šis UBIQUITI NETWORKS įrenginys atitinka esminius reikalavimus ir kitas 1999/5/EB Direktyvos nuostatas.
Malti [Maltese]	Hawnhekk, UBIQUITI NETWORKS, jiddikjara li dan UBIQUITI NETWORKS device, jikkonforma mal- ti ijiet essenzjali u ma provvedimenti o rajn relevanti li hemm fid-Direttiva 1999/5/EC.
Norsk [Norwegian]	UBIQUITI NETWORKS erklærer herved at utstyret UBIQUITI NETWORKS device, er i samsvar med de grunnleggende krav og øvrige relevante krav i direktiv 1999/5/EF.
Slovensky [Slovak]	UBIQUITI NETWORKS t mto vyhlasuje, e UBIQUITI NETWORKS device, sp a základné po iadavky a v etky príslu né ustanovenia Smernice 1999/5/ES.
Svenska [Swedish]	Härmed intygar UBIQUITI NETWORKS att denna UBIQUITI NETWORKS device, står i överensstämmelse med de väsentliga egenskapskrav och övriga relevanta bestämmelser som framgår av direktiv 1999/5/EG.
Español [Spanish]	Por medio de la presente UBIQUITI NETWORKS declara que el UBIQUITI NETWORKS device, cumple con los requisitos esenciales y cualesquiera otras disposiciones aplicables o exigibles de la Directiva 1999/5/CE.
Polski [Polish]	Niniejszym, firma UBIQUITI NETWORKS o wiadcza, e produkt serii UBIQUITI NETWORKS device, spełnia zasadnicze wymagania i inne istotne postanowienia Dyrektywy 1999/5/EC.
Português [Portuguese]	UBIQUITI NETWORKS declara que este UBIQUITI NETWORKS device, está conforme com os requisitos essenciais e outras disposições da Directiva 1999/5/CE.
Română [Romanian]	Prin prezenta, UBIQUITI NETWORKS declară că acest dispozitiv UBIQUITI NETWORKS este în conformitate cu cerințele esențiale și alte prevederi relevante ale Directivei 1999/5/CE.

Ubiquiti Networks Support

Email: **support@ubnt.com**

Phone (9 a.m. - 5 p.m. PST): **408-942-1153**

Online Resources

Wiki Page: **wiki.ubnt.com**

Support Forum: **forum.ubnt.com**

Downloads: **downloads.ubnt.com**

