

TP-LINK®

Archer C50

User Guide

AC1200 Wireless Dual Band Router

Contents

About This Guide	1
Chapter 1. Get to Know About Your Router	2
1. 1. Product Overview	3
1. 2. Main Features	4
1. 3. Panel Layout	5
1. 3. 1.Top View	5
1. 3. 2.The Back Panel	6
Chapter 2. Connect the Hardware	8
2. 1. Position Your Router	9
2. 2. Connect Your Router	9
Chapter 3. Log into Your Router	12
Chapter 4. Set Up Internet Connections	14
4. 1. Quick Setup	15
4. 2. Manually Configure Your Internet Connection Settings	17
4. 3. Setting Up an IPv6 Internet Connection	21
Chapter 5. Guest Network	25
5. 1. Create Guest Network	26
5. 2. Customize Guest Network Options	26
Chapter 6. USB Application	28
6. 1. Local Storage Sharing	29
6. 1. 1.Access the USB Disk	29
6. 1. 2.Customize Your Settings	31
6. 2. Remote Access via FTP Server	34
6. 2. 1.Access the USB Disk	34
6. 2. 2.Customize Your Settings	37
6. 3. Media Sharing	38
6. 3. 1.Access the USB Disk	38

6. 3. 2. Customize Your Settings	39
6. 4. Printer Sharing	40
Chapter 7. Parental Control	45
Chapter 8. Bandwidth Control	49
Chapter 9. Network Security	53
9. 1. Protect the Network from Cyber Attacks	54
9. 2. Access Control	55
9. 3. IP & MAC Binding	57
Chapter 10. NAT Forwarding	60
10. 1. Share Local Resources in the Internet by Virtual Server	61
10. 2. Open Ports Dynamically by Port Triggering	63
10. 3. Make Applications Free from Port Restriction by DMZ	64
10. 4. Make Xbox Online Games Run Smoothly by UPnP	65
Chapter 11. Customize Your Network Settings	66
11. 1. Change the LAN Settings	67
11. 2. Configure to Support IPTV Service	67
11. 3. Specify DHCP Server Settings	69
11. 4. Set Up a Dynamic DNS Service Account	70
11. 5. Create Static Routes	71
11. 6. Specify Wireless Settings	73
11. 7. Use WPS for Wireless Connection	75
11. 7. 1. Set the Router's PIN	76
11. 7. 2. Use the WPS Wizard for Wi-Fi Connections	76
11. 8. Schedule Your Wireless Function	77
Chapter 12. Manage the Router	79
12. 1. Set Up System Time	80
12. 2. Test the Network Connectivity	81
12. 3. Upgrade the Firmware	83
12. 4. Backup and Restore Configuration Settings	83
12. 5. Change the Administrator Account	84
12. 6. Local Management	85

12. 7. Remote Management	86
12. 8. System Log	86
12. 9. SNMP Settings	88
12. 10. Monitor the Internet Traffic Statistics	89

FAQ	91
------------------	-----------



Specifications	102
-----------------------------	------------

About This Guide

This guide provides details of each function and shows how to configure the router appropriate to your needs. In addition to this guide, a Quick Installation Guide is also released with each TP-LINK router, you are suggested to configure your router for quick Internet setup by following the published Quick Installation Guide before you get started with a further configuration.

Conventions

In this guide the following conventions are used:

Convention	Description
router	Stands for Archer C50 Wireless Dual Band Router without any explanation.
parameters	Parameters provided in the screenshots are just references for setting up the device, which may differ from the actual situation. You can set the parameters according to your demand.
screenshots	The demonstrated screenshots may look a little different from the actual web page of your device due to the various firmware versions. Please just configure your product based on the actual web page.
<i>Blue Italic</i>	Hyperlinks are in blue italic. You can click to redirect to a website or a specific section.
Blue	Contents to be emphasized and texts on the web page are in blue, including the menus, items, buttons, etc.
>	The menu structures to show the path to load the corresponding page. For example, Advanced > Wireless > MAC Filtering means the MAC Filtering function page is under the Wireless menu that is located in the Advanced tab.
Note:	Ignoring this type of note might result in a malfunction or damage to the device.
Tips:	Indicates important information that helps you make better use of your device.
symbols on the web page	<ul style="list-style-type: none"> click to edit the corresponding entry. click to delete the corresponding entry. click to enable or disable the corresponding entry.

Chapter 1

Get to Know About Your Router

This chapter introduces what the router can do and shows its main features and appearance.

This chapter contains the following sections:

- *Product Overview*
- *Main Features*
- *Panel Layout*

1.1. Product Overview

What This Product Does

The Archer C50 AC1200 Wireless Dual Band Router integrates 4-port Switch, Firewall, NAT-router and Wireless AP. The AC1200 Wireless Dual Band Router delivers exceptional range and speed, which can fully meet the need of Small Office/Home Office (SOHO) networks and the users demanding higher networking performance. Your wireless connections are radio band selectable to avoid interference in your area.

Fast Wireless Speed with 802.11ac

The Archer C50 comes with the next generation Wi-Fi standard – 802.11ac, 3 times faster than wireless N speeds and delivering a combined wireless data transfer rate of up to 1.2Gbps. With 300Mbps over the 2.4GHz band and 867Mbps wireless speeds over the crystal clear 5GHz band, the Archer C50 is the superior choice for seamless HD streaming, online gaming and other bandwidth-intensive tasks.

Dual Band Connections for Lag-Free Work and Entertainment

The Archer C50 operates over both the 2.4GHz and 5GHz bands, ensuring amazing wireless performance. Simultaneous Dual Band offers you the flexibility of two dedicated networks – with multiple times the bandwidth for your needs. Simple tasks like sending e-mails or web browsing can be handled by the 2.4GHz band while bandwidth intensive tasks like online gaming or HD video streaming can be processed by the 5GHz band – all at the same time.

Multifunctional USB Port – Easy Storage and Sharing

Using the USB 2.0 port, you can share a printer with multiple computers and devices on your network and can also share files & media at home or via the FTP server while away from home.

Guest Network

Guest Network Access provides secure Wi-Fi access for guests sharing your home or office network in a controlled manner without exposing private Wi-Fi access codes or other personal data.

Parental Control

Parental Controls allow parents or administrators to deploy restricted access for children or staff. With URL blocking, you can easily set up a black or white list to limit the level of web access.

Tether APP

TP-LINK Tether provides the easiest way to access and manage your router with your devices.

1.2. Main Features

- Complies with IEEE 802.11ac.
- One 10/100M Auto-Negotiation RJ45 Internet port, four 10/100M Auto-Negotiation RJ45 Ethernet ports, supporting Auto MDI/MDIX.
- Provides USB 2.0 port supporting storage/FTP/Media/Print Server.
- Provides WPA/WPA2, WPA2-PSK authentication, TKIP/AES encryption security.
- Shares data and Internet access for users, supporting Dynamic IP/ Static IP/ PPPoE/ PPTP/ L2TP/ BigPond Cable Internet access.
- Supports simultaneous 2.4GHz and 5GHz connections for 1167Mbps of total available bandwidth.
- Supports Virtual Server, Port Triggering, DMZ host and UPnP.
- Supports Dynamic DNS, Static Routing.
- Provides Automatic-connection and Scheduled Connection on certain time to the Internet.
- Built-in NAT and DHCP server supporting static IP address distributing.
- Supports Parental Control and Access Control.
- Connects Internet on demand and disconnects from the Internet when idle for PPPoE.
- Provides 64/128-bit WEP encryption security and wireless LAN ACL (Access Control List).
- Supports Traffic Statistics.
- Supports IPv6.
- Supports firmware upgrade and Web management.

1.3. Panel Layout

1.3.1. Top View





The router's LEDs are located on the top panel (view from left to right). You can check the router's working status by following the LED Explanation table.

LED Explanation

Name	Status	Indication
⏻ (Power)	On	System initialization completes.
	Flashing	System initialization or firmware upgrade is in process. Do not disconnect or power off the router.
	Off	Power is off. Please ensure that the power adapter is connected correctly.
📶 (2.4GHz Wireless)	On	The wireless 2.4GHz band is working properly.
	Off	The wireless 2.4 GHz band is disabled.
📶 (5GHz Wireless)	On	The wireless 5GHz band is working properly.
	Off	The wireless 5GHz band is disabled.
🌐 (Internet)	Green	The router is connected to the Internet.
	Orange	The WAN port is connected, but there is no Internet connection.
	Off	The WAN port is not connected.

LED Explanation

Name	Status	Indication
 (LAN)	On	At least one LAN port is connected.
	Off	No LAN port is connected.
 (USB)	On	The USB device is identified and ready to use.
	Flashing	The USB device is being identified.
	Off	No USB device is plugged into the USB port or the USB device is not identified or USB device has been safely ejected.
 (WPS)	On/Off	Turns On when a WPS synchronization is established and automatically turns Off about 5 minutes later.
	Flashing	A wireless device is trying to connect to the network via WPS. This process may take up to 2 minutes.

1.3.2. The Back Panel



The router's back panel shows the connection ports, buttons and antennas (view from left to right). Refer to the following for detailed instructions.

Item	Description
Wi-Fi Button	Press this Wi-Fi button for about 2 seconds to turn on or off the wireless function of your router.

Item	Description
WPS/Reset	<p>Used as WPS button: Pressing this button for less than 5 seconds enables the WPS function. If your client devices, such as wireless adapters, that support Wi-Fi Protected Setup, then you can press this button to quickly establish a connection between the router and client devices and automatically configure wireless security for your wireless network.</p> <p>Used as RESET button: Press and hold this button for more than 5 seconds to reset the router.</p>
Internet Port	This port is where you'll connect to the DSL/Cable modem, or Ethernet.
LAN1, LAN2, LAN3, LAN4	These ports (1, 2, 3, 4) connect the router to the local PC(s).
USB 2.0	For connecting to a 2.0 USB storage device or a 2.0 USB printer.
Power On/Off Button	Press this button to power on or off the router.
Power	For connecting the router to power socket via the provided power adapter.

Chapter 2

Connect the Hardware

This chapter contains the following sections:

- *Position Your Router*
- *Connect Your Router*

2.1. Position Your Router

- The Product should not be located where it will be exposed to moisture or excessive heat.
- Place the router in a location where it can be connected to the various devices as well as to a power source.
- Make sure the cables and power cord are safely placed out of the way so they do not create a tripping hazard.
- The router can be placed on a shelf or desktop.
- Keep away from the strong electromagnetic radiation and the device of electromagnetic sensitive.

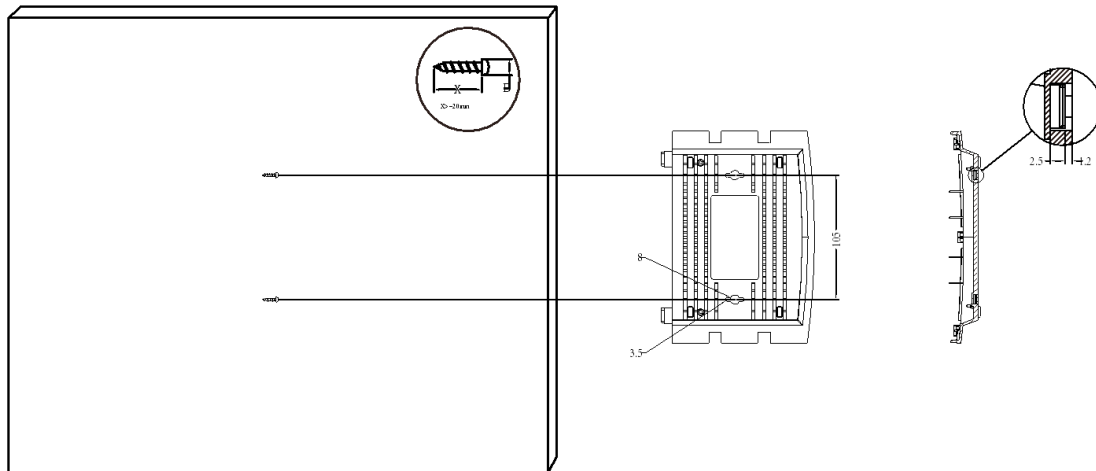

Note:

The diameter of the screw ranges from 3.5 mm to 8 mm, and the distance between two screws is 105 mm. The screw that projects from the wall needs around 4.5 mm base, and the length of the screw needs to be at least 20 mm to withstand the weight of the product.

2.2. Connect Your Router

Follow the steps below to connect your router.

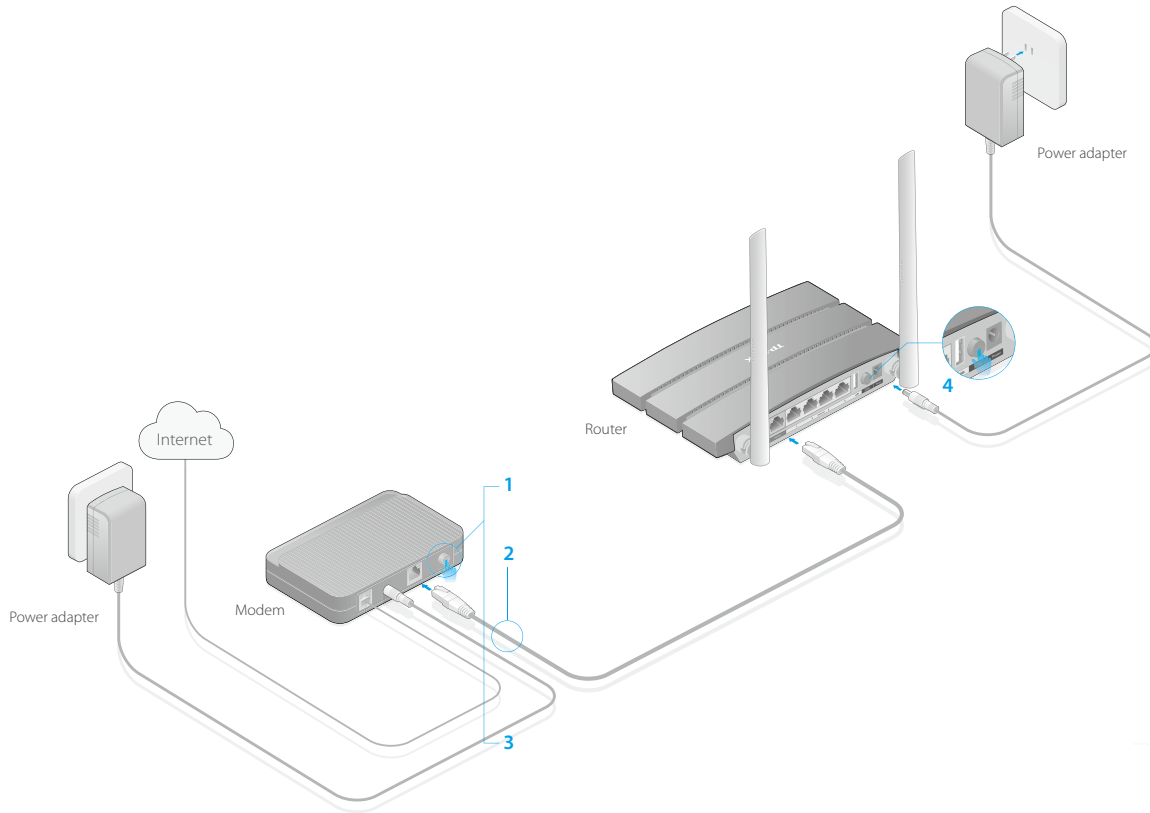

1. If your Internet connection is through an Ethernet cable from the wall instead of through a DSL / Cable / Satellite modem, connect the Ethernet cable directly to the router's Internet port, then follow steps 4 and 5 to complete the hardware connection.



- 1) Turn off the modem, and remove the backup battery if it has one.
- 2) Connect the modem to the Internet port on your router with an Ethernet cable.
- 3) Turn on the modem, and then wait about 2 minutes for it to restart.
- 4) Turn on the router.
- 5) Verify that the hardware connection is correct by checking these LEDs.



Note:

If the 2.4G LED  and 5G LED  are off, please press the Wi-Fi On/Off button on the side panel for 2 seconds and check the LEDs again in a few seconds later.

2. Connect your computer to the router.

• Method 1: Wired

Turn off the Wi-Fi on your computer and connect the devices as shown below.

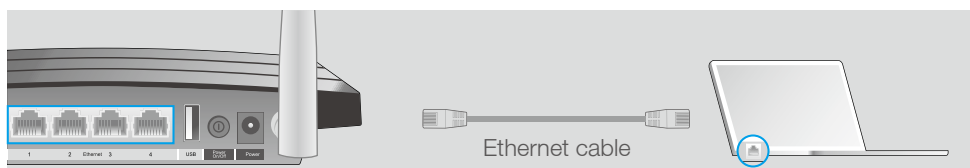

• Method 2: Wirelessly

Connect wirelessly by using the SSID (Network Name) and Wireless Password/PIN printed on the product label at the bottom of the router.

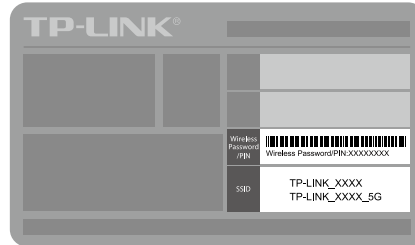

• Method 3: Use the WPS button

Wireless devices that support WPS, including Android phones, tablets, most USB network cards, can be connected to your router through this method.(WPS is not supported by IOS devices.)

■ Note:

The WPS function cannot be configured if the wireless function of the router is disabled. Also, the WPS function will be disabled if your wireless encryption is WEP. Please make sure the wireless function is enabled and is configured with the appropriate encryption before configuring the WPS.

1. Tab the WPS icon on the device's screen.
2. Immediately press the WPS button on your router.



close to



Chapter 3

Log into Your Router

With a Web-based utility, it is easy to configure and manage the router. The Web-based utility can be used on any Windows, Macintosh or UNIX OS with a Web browser, such as Microsoft Internet Explorer, Mozilla Firefox or Apple Safari.

Follow the steps below to log into your router.

1. Set up the TCP/IP Protocol in [Obtain an IP address automatically](#) mode on your computer.
2. Visit <http://tplinkwifi.net>, and log in with the username and password you've set for the router. The default one is [admin](#) for both username and password.

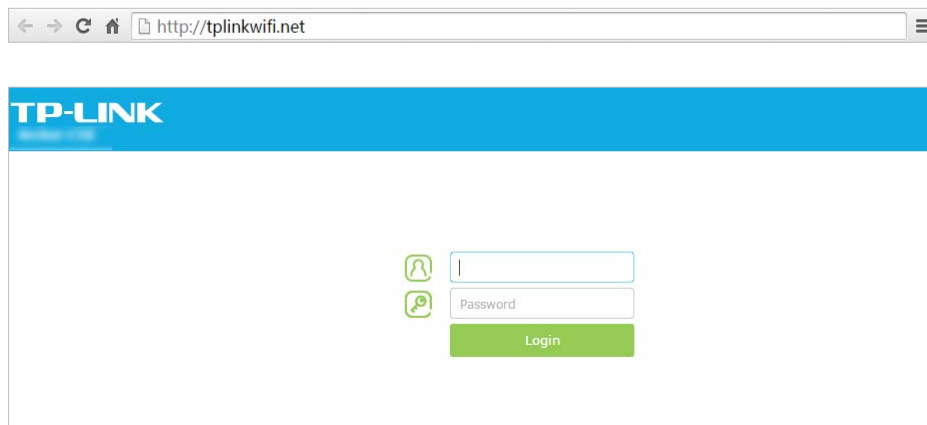

Note:

If the login window does not appear, please refer to [FAQ](#).

Chapter 4

Set Up Internet Connections

This chapter introduces how to connect your router to the Internet. The router is equipped with a web-based Quick Setup wizard. It has many ISP information built in, automates many of the steps and verifies that those steps have been successfully completed. Furthermore, you can also set up an IPv6 connection if your ISP provided IPv6 service.

This chapter contains the following sections:

- [*Quick Setup*](#)
- [*Manually Configure Your Internet Connection Settings*](#)
- [*Setting Up an IPv6 Internet Connection*](#)

4.1. Quick Setup

The Quick Setup Wizard will guide you through the process to set up your router to access the Internet.

Tips:

If you need the IPv6 Internet connection, please refer to the section of [“4.3. Setting Up an IPv6 Internet Connection”](#).

Follow the steps below to set up your router to access the Internet.

1. Visit <http://tplinkwifi.net>, and log in with the password you set for the router.
2. Go to [Quick Setup](#) on the top of the page.
3. Select your Time Zone from the drop-down list and click [Next](#).

The screenshot shows the 'Time Zone' selection step in the Quick Setup Wizard. At the top, a progress bar indicates the current step is 'Time Zone', with other steps being 'Internet Connection Type', 'Wireless Setting', 'Summary', and 'Connection Test'. Below the progress bar, the text 'Time Zone:' is followed by a dropdown menu showing '(GMT-08:00) Pacific Time (US & Canada); Tijuana'. At the bottom right, there are two green buttons: 'Exit' and 'Next'.

4. Click [Auto Detect](#) and the router will detect your connection type automatically.

Note:

You can also choose the connection type manually. If you use DSL line and you are only provided an account name and a password by your ISP, choose PPPoE. If you use cable TV or fiber cable, choose Dynamic IP. If you are provided more information such as IP address, Subnet Mask and Default Gateway, choose Static IP. Contact your ISP if you are not sure about the Internet connection information.

The screenshot shows the 'Internet Connection Type' selection step in the Quick Setup Wizard. At the top, a progress bar indicates the current step is 'Internet Connection Type', with other steps being 'Time Zone', 'Wireless Setting', 'Summary', and 'Connection Test'. Below the progress bar, there is a blue button labeled 'Auto Detect'. Underneath, there are five radio button options: 'Dynamic IP' (which is selected), 'Static IP', 'PPPoE', 'L2TP', and 'PPTP'. At the bottom, there is a note: 'Note: If you are not sure which Internet Connection Type you have, use Auto Detect or contact your Internet Service Provider (ISP) for assistance.' At the bottom right, there are two green buttons: 'Back' and 'Next'.

5. In this case, the router automatically detects Dynamic IP as the connection type. Click [Next](#).

Internet Connection Type

Wireless Setting

Connection Test

on and Time Zone

Summary

Auto Detect Detecting...

Dynamic IP

Static IP

PPPoE

L2TP

PPTP

Note: If you are not sure which Internet Connection Type you have, use Auto Detect or contact your Internet Service Provider (ISP) for assistance.

Back Next

6. Follow the instructions on the page to decide whether to clone MAC Address. Click [Next](#).

Internet Connection Type

Wireless Setting

Connection Test

Time Zone

Summary

If your ISP only allows Internet access to a specific MAC address, you need to Clone that MAC Address to provide access to other devices. If you are not sure, select [Do NOT clone MAC Address](#).

Do NOT clone MAC Address

Clone Current Computer MAC Address

Note: If you select Clone MAC Address, please make sure the MAC Address of this computer is registered with your ISP before clicking Next.

Back Next

7. Configure your wireless settings and click [Next](#).

Internet Connection Type

Wireless Setting

Connection Test

Time Zone

Summary

You can rename your wireless network name and create your own password.

Wireless 2.4GHz: Enable Wireless Radio

Wireless Network Name (SSID): TP-LINK_0507

Password: 12345670

Wireless 5GHz: Enable Wireless Radio

Wireless Network Name (SSID): TP-LINK_0507_5G

Password: 12345670

Back Next

Note:

You may customize your 2.4GHz/5GHz SSID and password. Once done, the wireless connection will disconnect automatically, and you must then use the new SSID/password to regain access to the Internet.

8. Confirm the information and click [Save](#).

Internet Connection Type Wireless Setting Connection Test

Time Zone Summary

Time Zone: (GMT-08:00) Pacific Time (US & Canada); Tijuana
 Internet Connection Type: Dynamic IP

Wireless 2.4GHz: Enabled
 Wireless Network Name (SSID): TP-LINK_0507
 Password: 12345670

Wireless 5GHz: Enabled
 Wireless Network Name (SSID): TP-LINK_0507_5G
 Password: 12345670

Back Save

9. Click [Test Internet Connection](#). If you successfully connect to the Internet, the screen will display as follows.

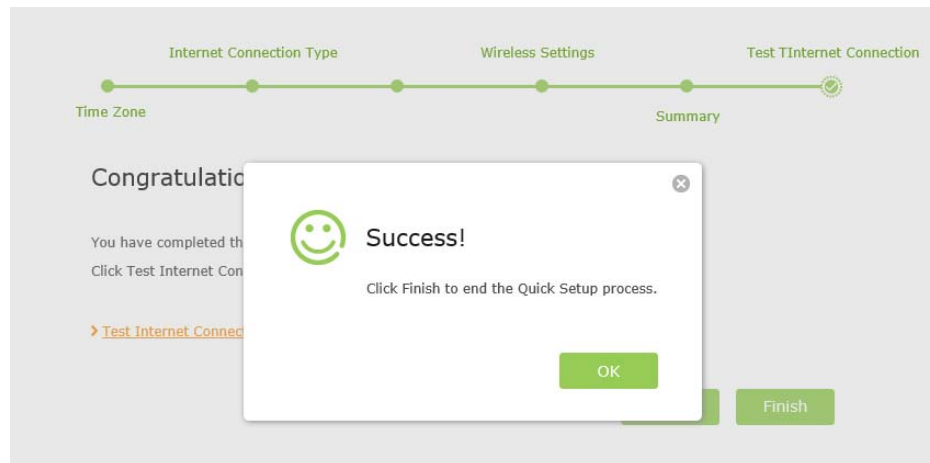

10. Now your computer and WiFi device can connect to the Internet!

Tips:

You can connect your computer to the router's LAN port using an Ethernet cable to join the local area network. You can also find and select the wireless network name on your WiFi device to join the WiFi network.

4.2. Manually Configure Your Internet Connection Settings

In this part, you can check your current Internet connection settings. You can also modify the settings according to the service information provided by your ISP.

Follow the steps below to check or modify your Internet connection settings.

1. Visit <http://tplinkwifi.net>, and log in with the password you set for the router.
2. Go to *Basic* > *Internet* on the left to enter the setting page.
3. Select your Internet connection type from the drop-down list.

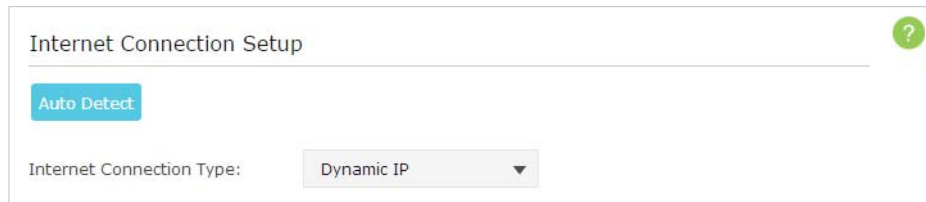

The screenshot shows the 'Internet Connection Setup' page. At the top right is a green help icon. Below the title is a blue 'Auto Detect' button. Underneath is the 'Internet Connection Type:' label followed by a dropdown menu currently set to 'Dynamic IP'.

Note:

If you are unsure what your connection type is, click [Auto Detect](#). Since different connection types need different cables and connection information, you can also refer to the demonstrations in Step 4 to judge your connection type.

4. Follow the instructions on the page to continue the configuration. Parameters on the figures are just used for demonstration.
 - 1) If you choose [Dynamic IP](#), you need to select whether to clone the MAC address. Dynamic IP users are usually equipped with cable TV or fiber cable.

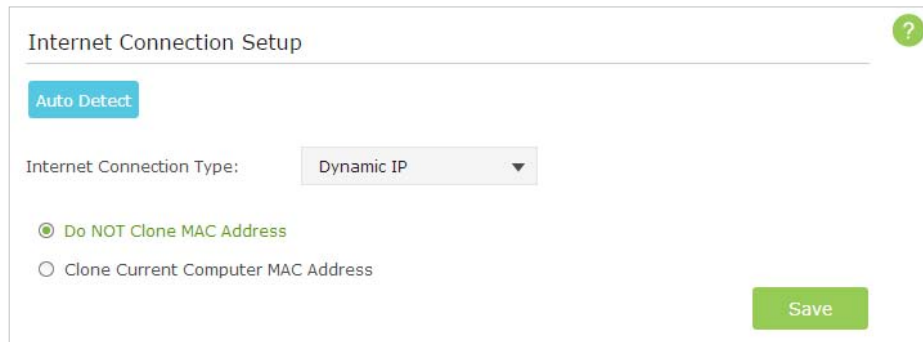

This screenshot shows the same 'Internet Connection Setup' page as the previous one, but with additional options. Below the 'Dynamic IP' dropdown, there are two radio buttons: 'Do NOT Clone MAC Address' (which is selected) and 'Clone Current Computer MAC Address'. A green 'Save' button is located at the bottom right of the form area.

- 2) If you choose [Static IP](#), enter the information provided by your ISP in the corresponding fields.

Internet Connection Setup

Auto Detect

Internet Connection Type: Static IP

IP Address: 192.168.203.218

Subnet Mask: 255.255.255.0

Default Gateway: 192.168.203.219

Primary DNS: 192.168.203.254

Secondary DNS: 192.168.202.254 (Optional)

Save

- 3) If you choose **PPPoE**, enter the **username** and **password** provided by your ISP. PPPoE users usually have DSL cable.

Internet Connection Setup

Auto Detect

Internet Connection Type: PPPoE

Username: 075504673554@163.gd

Password:

Save

- 4) If you choose **L2TP**, enter the **username** and **password** and choose the **Secondary Connection** provided by your ISP. Different parameters are needed according to the Secondary Connection.

Internet Connection Setup

Auto Detect

Internet Connection Type: L2TP

Username:

Password:

Secondary Connection: Dynamic IP Static IP

Server IP Address/Name:

Save

- 5) If you choose **PPTP**, enter the **username**, **password** and choose the **Secondary Connection** provided by your ISP. Different parameters are needed according to the Secondary Connection.

Internet Connection Setup

Auto Detect

Internet Connection Type: PPTP

Username: pptp

Password:

Secondary Connection: Dynamic IP Static IP

Server IP Address/Name:

Save

5. Click [Save](#) to make the settings take effect. To check your Internet connection, click [Network Map](#) on the left of the page.

Note:

It may take 1-2 minutes to make the settings valid.

6. After the connection succeed, the screen will display as follows. Here we take PPPoE as an example.

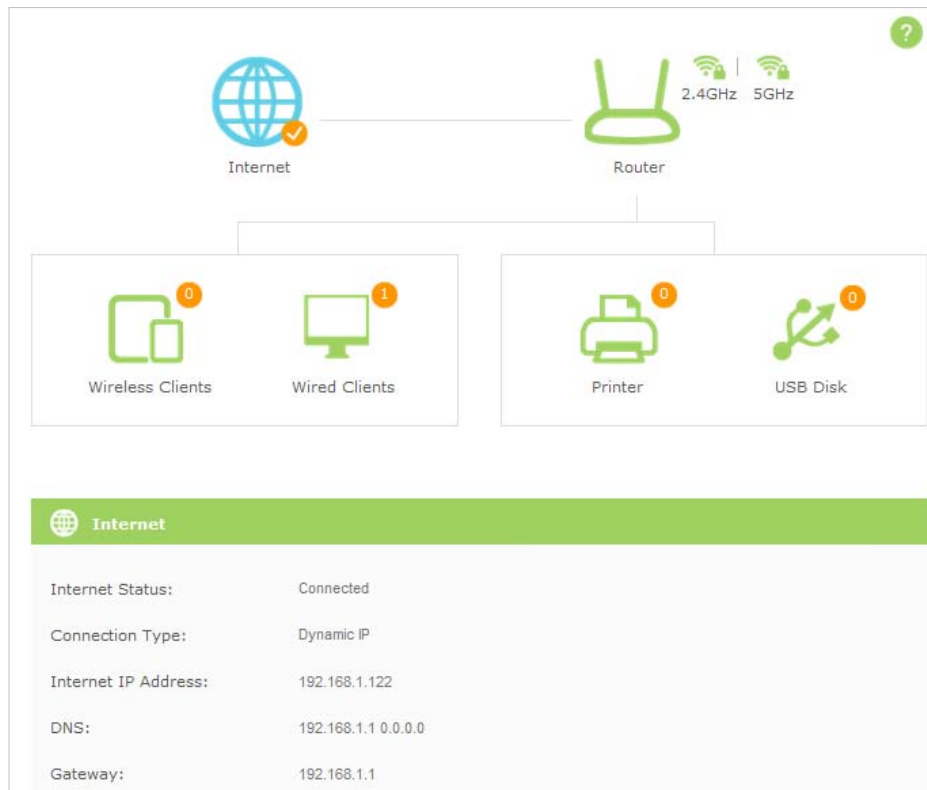

Tips:

1. If your Internet connection type is [Bigpond Cable](#), please go to [Advanced > Network > Internet](#).
2. If you use [Dynamic IP](#) and [PPPoE](#) and you are provided any other parameters that are not required on the page, please go to [Advanced > Network > Internet](#) to complete the configuration.
3. If you still cannot connect to the Internet, refer to [FAQ](#) for further instructions.

4.3. Setting Up an IPv6 Internet Connection

Your ISP provides information about one of the following Internet connection types: PPPoE, Dynamic IP, Static IP, 6to4 tunnel.

1. Visit <http://tplinkwifi.net>, then log in with the password you set for the router.
2. Go to [Advanced](#) > [IPv6](#) to log into the configuration page.

The screenshot shows two configuration panels. The top panel, titled "IPv6 Internet", has a green question mark icon in the top right corner. It contains the following settings: "Enable IPv6:" with a green toggle switch; "Internet Connection Type:" with a dropdown menu set to "Dynamic IP"; "IPv6 Address:" with the value "::"; "IPv6 Default Gateway:" with the value "::"; "Addressing Type:" with a dropdown menu set to "DHCPv6"; and a "Save" button. Below this panel is a "▼ Advanced" link. The bottom panel, titled "IPv6 LAN", contains the following settings: "Address Type:" with radio buttons for "RADVD" (selected) and "DHCPv6 Server"; "Enable RDNSS" with an unchecked checkbox; "Enable ULA Prefix" with an unchecked checkbox; "Site Prefix Type:" with radio buttons for "Delegated" (selected) and "Static"; and "Prefix Delegated WAN Connection:" with the value "ewan_ipoev6_d". A "Save" button is located at the bottom right of this panel.

3. Select the Internet connection type provided by ISP.

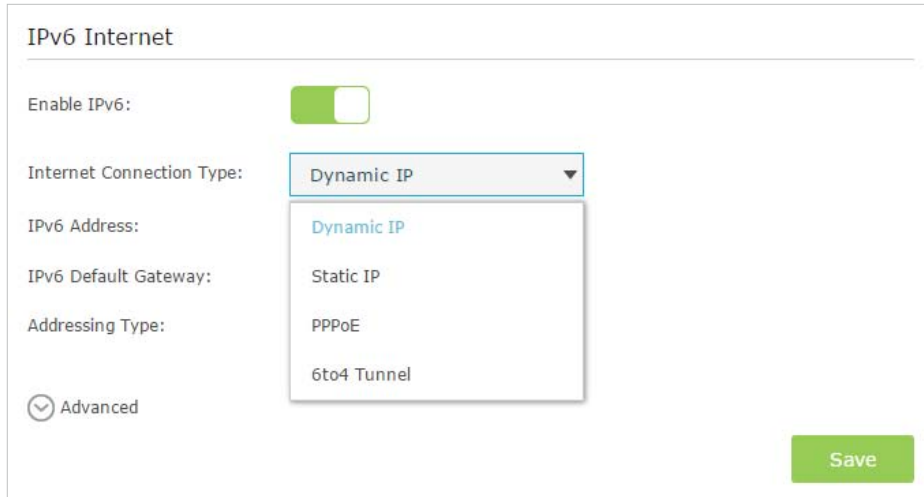

The screenshot shows the 'IPv6 Internet' configuration panel. At the top, the title 'IPv6 Internet' is displayed. Below it, there is a toggle switch for 'Enable IPv6' which is turned on. The 'Internet Connection Type' dropdown menu is open, showing 'Dynamic IP' as the selected option. Other options in the dropdown include 'Static IP', 'PPPoE', and '6to4 Tunnel'. Below the dropdown, there are input fields for 'IPv6 Address', 'IPv6 Default Gateway', and 'Addressing Type'. At the bottom left, there is a 'Advanced' toggle switch which is currently turned off. A green 'Save' button is located at the bottom right of the panel.

Tips:

If you do not know what your Internet connection type is, contact your ISP or judge according to already known information provided by your ISP.

4. Fill in information as required by different connection type. (IPv6 Address must be filled.)

1) **Static IP:** Fill in blanks and click [Save](#).



The screenshot shows the 'IPv6 Internet' configuration panel with 'Static IP' selected in the 'Internet Connection Type' dropdown. Below the dropdown, there are input fields for 'IPv6 Address', 'IPv6 Default Gateway', 'Primary IPv6 DNS', and 'Secondary IPv6 DNS'. Each of these fields contains '::' and is followed by '(optional)' text. The 'Advanced' toggle switch is turned off. A green 'Save' button is located at the bottom right of the panel.

2) **Dynamic IP:** Click [Advanced](#) to have more configuration if ISP requires. Click [Save](#) to finish the configuration.

IPv6 Internet

Enable IPv6:

Internet Connection Type: Dynamic IP

IPv6 Address: ::

IPv6 Default Gateway: ::

Addressing Type: DHCPv6

Advanced

Save

- 3) **PPPoE:** Fill in the Username and Password, and select the [Addressing Type](#). Click [Advanced](#) to have more configuration if ISP requires. Click [Save](#) to finish the configuration.

IPv6 Internet

Enable IPv6:

Internet Connection Type: PPPoE

Username:

Password:

Confirm password:

Addressing Type: DHCPv6

Advanced

Save

- 4) **6to4 Tunnel:** An IPv4 Internet connection type is a prerequisite for this connection type. (Go to [Manually Configure Your Internet Connection Settings](#) for more information.) Click [Save](#) to finish the configuration.

IPv6 Internet

Enable IPv6:

Internet Connection Type: 6to4 Tunnel

WAN Connection: No available interface

Save

5. Configure the IPv6 LAN settings. Leave the settings as default, and click [Save](#) to save the settings.

Tips:

Find [Help](#) on the management interface to know more about items.

IPv6 LAN

Address Type: RADVD DHCPv6 Server

Enable RDNSS

Enable ULA Prefix

Site Prefix Type: Delegated Static

Prefix Delegated WAN Connection: ewan_ipoev6_d

[Save](#)

6. Click [Status](#) to check whether you succeed or not. The following figure is an example of a successful PPPoE configuration.

Internet ✓		IPv4 IPv6
MAC Address:	00-0A-EB-AC-25-01	
IP Address:	2001:c68:202:2111::120/64	
Default Gateway:	fe80::edd0:80d2:7f5e:6be7	
Primary DNS:	2001:c68:202:2111::1	
Secondary DNS:	2001:c68:202:2111::2	
Connection Type:	PPPoE	

Tips:

Visit [FAQ](#) if there is no Internet connection.

Chapter 5

Guest Network

This function allows you to provide Wi-Fi access for guests without disclosing your main network. When you have guests in your house, apartment, or workplace, you can create a guest network for them. In addition, you can limit the network authorities for guests to ensure network security and privacy.

This chapter contains the following sections:

- [*Create Guest Network*](#)
- [*Customize Guest Network Options*](#)

5.1. Create Guest Network

1. Visit <http://tplinkwifi.net>, and log in with the username and password you set for the router.
2. Go to [Advanced](#) > [Guest Network](#).
3. Create a 2.4GHz or 5GHz guest network according to your needs.
 - 1) Enable [Wireless Network 2.4GHz](#) or [Wireless Network 5GHz](#).
 - 2) Set an easy-to-identify SSID. Don't select [Hide SSID](#) unless you want your guests and other people to manually input this SSID for Wi-Fi access.
 - 3) Set [Security](#) to [WPA/WPA2 Personal](#), keep the default [Version](#) and [Encryption](#) values, and set an easy-to-remember [Password](#).

Wireless Settings

Wireless 2.4GHz: Enable Wireless Radio

Wireless Network Name (SSID): Hide SSID

Security: No Security WPA/WPA2 Personal

Version: Auto WPA2-PSK

Encryption: Auto TKIP AES

Password:

Wireless 5GHz: Enable Wireless Radio

Wireless Network Name (SSID): Hide SSID

Security: No Security WPA/WPA2 Personal

4. Click [Save](#). Now your guests can access your guest network using the SSID and password you set!

Tips:

To view guest network information, go to [Advanced](#) > [Status](#) and find the Guest Network section.

5.2. Customize Guest Network Options

1. Visit <http://tplinkwifi.net>, and log in with the password you set for the router.
2. Go to [Advanced](#) > [Guest Network](#).
3. Customize guest network options according to your needs.

Settings

See each other: Allow guests to see each other

Access my local network: Allow guests to access my local network

USB Storage Sharing: Allow guests to access my USB storage sharing

Bandwidth Control: Enable guest network bandwidth control

Egress Rate (kbps): 100 - 200

Ingress Rate (kbps): 100 - 200

Save

- [Allow guests to see each other](#)

Select this checkbox if you want to allow the clients in your guest network to access each other.

- [Allow guests to access my local network](#)

Select this checkbox if you want to allow the clients in your guest network to access your local network, not just Internet access.

- [Allow guests to access my USB storage sharing](#)

Select this checkbox if you want to allow the clients in your guest network to access your router's USB storage sharing.

- [Enable guest network bandwidth control](#)

Select this checkbox if you want to assign the upstream and downstream bandwidth for the guest network. This option is available only when [Bandwidth Control](#) is enabled on the [Advanced > Bandwidth Control](#) page.

4. Click [Save](#). Now users in your guest network can enjoy only the network authorities you assigned!

 **Tips:**

To view guest network information, go to [Advanced > Status](#) and find the [Guest Network](#) section.

Chapter 6

USB Application

This chapter describes how to share and access USB devices connected to the router among different clients.

The router only supports USB external flash drives, hard drives, USB printers and USB 3G/4G modems.

This chapter contains the following sections:

- *Local Storage Sharing*
- *Remote Access via FTP Server*
- *Media Sharing*
- *Printer Sharing*

6.1. Local Storage Sharing

Share your USB storage devices with different users on the network.

6.1.1. Access the USB Disk

1. Connect Your USB Disk

Insert your USB storage device into the router's USB port directly or using a USB cable. Wait several seconds until the USB LED becomes solid on.

🔗 Tips:

- If you use USB hubs, make sure no more than 4 devices are connected to the router.
- If the USB storage device requires using bundled external power, make sure the external power has been connected.
- If you use a USB hard drive, make sure its file system is FAT32 or NTFS.
- Before you physically disconnect a USB device from the router, safely remove it to avoid data damage: Go to [Advanced](#) > [USB Settings](#) > [Disk Settings](#) and click [Safely Remove](#).

2. Access Your USB Disk

By default, all the network clients can access all folders on your USB disk. Refer to the following table for access instructions. You can also customize your sharing content and set a sharing account by referring to [Customize Your Settings](#).

Windows computer

➤ **Method 1:**

Go to [Computer](#) > [Network](#), then click the Network Server Name in the [Computer](#) section.

■ **Note:**
Operations in different systems are similar. Here we take Windows 7 as an example.

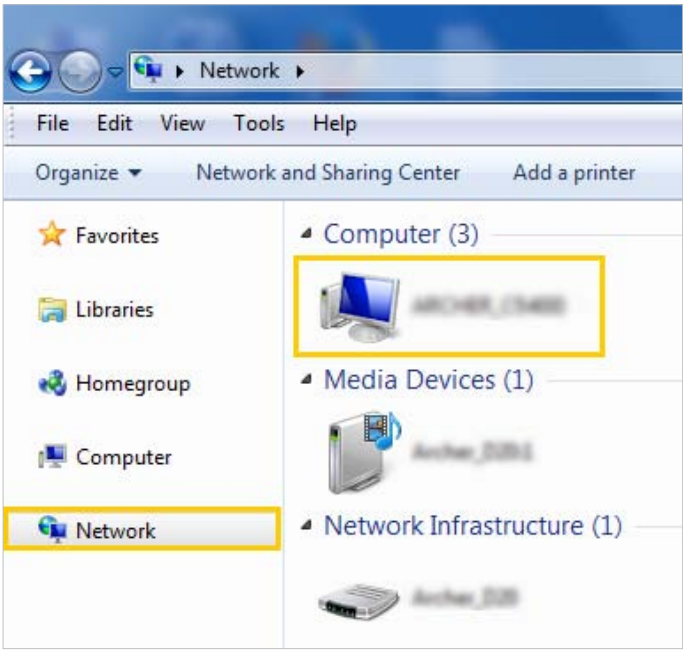

The screenshot shows a Windows 7 Network window. The address bar shows 'Network'. The left sidebar has 'Network' selected. The main pane shows a tree view with 'Computer (3)', 'Media Devices (1)', and 'Network Infrastructure (1)'. Under 'Computer (3)', a computer icon is highlighted with a yellow box.

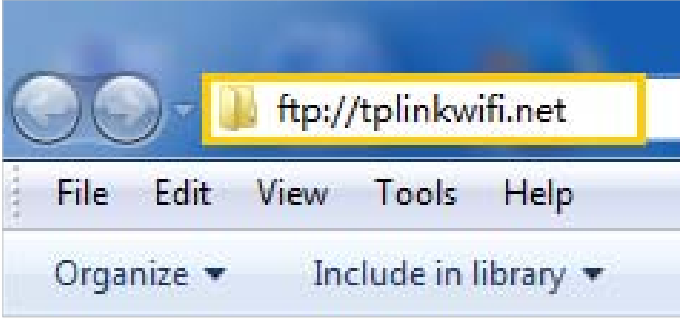
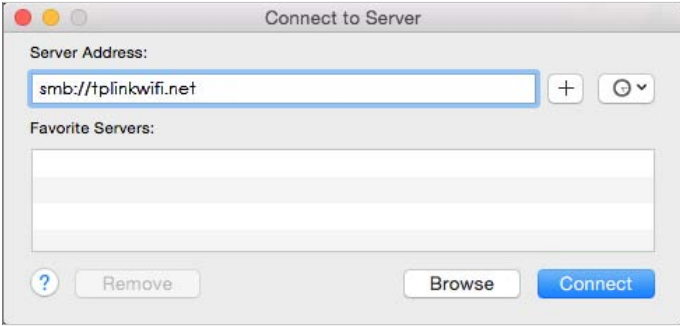
<p>Windows computer</p>	<p>➤ Method 2:</p> <p>Open the Windows Explorer (or go to Computer) and type the server address \\tplinkwifi.net or ftp://tplinkwifi.net in the address bar, then press [Enter].</p> 
<p>Mac</p>	<ol style="list-style-type: none"> 1) Select Go > Connect to Server 2) Type the server address smb://tplinkwifi.net 3) Click Connect.  <ol style="list-style-type: none"> 4) When prompted, select the Guest radio box. (If you have set up a username and a password to deny anonymous access to the USB disks, you should select the Registered User radio box. To learn how to set up an account for the access, refer to To Set up Authentication for Data Security.)
<p>Pad</p>	<p>Use a third-party app for network files management.</p>

 **Tips:**

You can also access your USB disk by using your Network/Media Server Name as the server address. Refer to [To Customize the Address of the USB Disk](#) to learn more.

6.1.2. Customize Your Settings

➤ To Only Share Specific Content

By default, [Share All](#) is enabled so all content on the USB disk is shared. If you want to only share specific folders, follow the steps below:

1. Visit <http://tplinkwifi.net>, then log in with the username and password you've set for the router.
2. Go to [Basic](#) > [USB Settings](#) > [Folder Sharing](#). Focus on the [Folder Sharing](#) section.
3. Click the button to disable [Share All](#), then click [Add](#) to add a new sharing folder.

The screenshot shows the 'Folder Sharing' configuration page. At the top, there is a 'Share All' toggle switch. Below it, there are '+ Add' and '- Delete' buttons. A table with the following columns is visible: ID, Folder Name, Folder Path, Media Sharing, Volume, Status, and Modify. Below the table, there are input fields for 'Volume Name', 'Folder Path', and 'Folder Name'. The 'Volume Name' field has a dropdown menu with 'Select a folder' selected. The 'Folder Path' field has a 'Browse' button next to it. Below these fields are three checkboxes: 'Enable Authentication', 'Enable Write Access', and 'Enable Media Sharing'. At the bottom right, there are 'Cancel' and 'OK' buttons.

4. Select the [Volume Name](#) and [Folder Path](#), then enter a [Folder Name](#) as you like.
5. Decide the way you share the folder:
 - [Enable Authentication](#): If you tick this check box, you will be required to use a username and password to access the folder. Refer to [To Set up Authentication for Data Security](#) to learn more.
 - [Enable Write Access](#): If you tick this check box, network clients can modify the folder.
 - [Enable Media Sharing](#): If you tick this check box, you can view photos, play music and watch movies in the folder directly from DLNA-supported devices. Refer to [Media Sharing](#) to learn more.
6. Click [OK](#).

Tips:

The router can share 14 volumes at most. You can click  on the page to detach the corresponding volume you do not need to share.

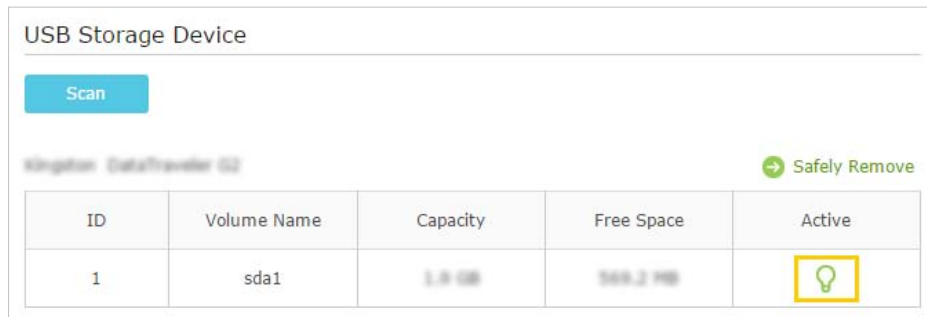

➤ To Set up Authentication for Data Security

If you enable Authentication, network clients will be required to enter the username and password you set when accessing the USB disk.

1. Visit <http://tplinkwifi.net>, then log in with the username and password you've set for the router.
2. Go to **Advanced > USB Settings > Folder Sharing**. Focus on the **Sharing Account** section.

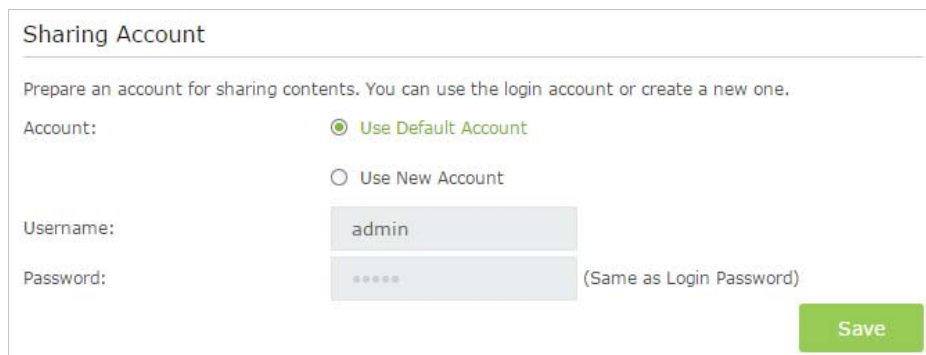

Sharing Account

Prepare an account for sharing contents. You can use the login account or create a new one.

Account: Use Default Account Use New Account

Username:

Password: (Same as Login Password)

3. Choose **Use Default Account** (admin) or **Use New Account** and click **Save**.
4. Enable Authentication to apply the account you just set.
 - If you leave **Share All** enabled, click the button to enable Authentication for all folders.

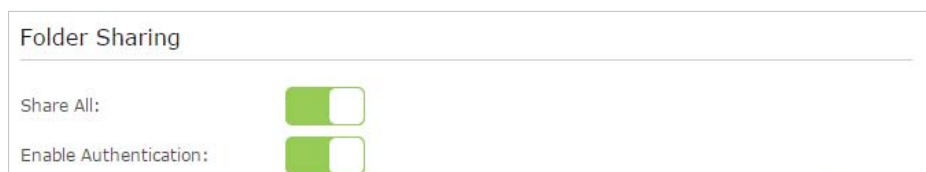

Folder Sharing

Share All:

Enable Authentication:

- If **Share All** is disabled, enable Authentication for specific folders.

Folder Sharing

Share All:

+ Add - Delete

<input type="checkbox"/>	ID	Folder Name	Folder Path	Media Sharing	Volume	Status	Modify
--	--	--	--	--	--	--	--

Volume Name:

Folder Path:

Folder Name:

Enable Authentication

Enable Write Access

Enable Media Sharing

Note:

Due to Windows credential mechanism, you might be unable to access the USB disk after changing Authentication settings. Please log out from Windows and try to access again. For more details, please refer to [FAQ](#).

➤ **To Customize the Address of the USB Disk**

You can customize the server name and use the name to access your USB disk.

1. Visit <http://tplinkwifi.net>, then log in with the username and password you've set for the router.
2. Go to [Advanced](#) > [USB Settings](#) > [Folder Sharing](#). Focus on the [Sharing Setting](#) section.
3. Make sure [Network Neighborhood](#) is ticked, and enter a Network/Media Server Name as you like, such as [My-Share](#), then click [Save](#).

Sharing Setting

Network/Media Server Name:

Enable	Access Method	Link	Port
<input checked="" type="checkbox"/>	Media Server	--	--
<input checked="" type="checkbox"/>	Network Neighborhood	\\My-Share	--
<input checked="" type="checkbox"/>	FTP	ftp://192.168.0.1:21	<input type="text" value="21"/>
<input type="checkbox"/>	FTP(via Internet)	ftp://0.0.0.0:21	21

3. Now you can access the USB disk by visiting `\\My-Share` (for Windows) or `smb://My-Share` (for Mac).

6.2. Remote Access via FTP Server

You can access your USB disk outside the local area network.

For example:

- Share photos and other large files with your friends without logging in to (and paying for) a photo-sharing site or email system.
- Get a safe backup for the materials for a presentation.
- Remove the files on your camera's memory card from time to time during the journey.

Note:

If your ISP assigns a private WAN IP address (such as 192.168.x.x or 10.x.x.x), you cannot use this feature because private addresses are not routed on the Internet.

6.2.1. Access the USB Disk

1. Connect Your USB Disk

Insert your USB storage device into the router's USB port directly or using a USB cable. Wait several seconds until the USB LED becomes solid on.

 **Tips:**

- If you use USB hubs, make sure no more than 4 devices are connected to the router.
- If the USB storage device requires using bundled external power, make sure the external power has been connected.
- If you use a USB hard drive, make sure its file system is FAT32 or NTFS.
- Before you physically disconnect a USB device from the router, safely remove it to avoid data damage: Select **Advanced** > **USB Settings** > **Disk Settings** and click  **Safely Remove**.

2. Enable Authentication for Data Security

It is strongly recommended that you set and apply a sharing account for data security.

- 1) Visit <http://tplinkwifi.net>, then log in with the username and password you've set for the router.
- 2) Go to **Advanced** > **USB Settings** > **Folder Sharing**. Focus on the **Sharing Account** section.
- 3) Choose to **Use default Account** (admin) or **Use New Account** and click **Save**.

Sharing Account

Prepare an account for sharing contents. You can use the login account or create a new one.

Account: Use Default Account
 Use New Account

Username:

Password: (Same as Login Password)

Save

- 4) Enable **Authentication** to apply the sharing account.
- If you leave **Share All** enabled, click the button to enable **Authentication** for all folders.

Folder Sharing

Share All:

Enable Authentication:

- If **Share All** is disabled, enable **Authentication** for specific folders.

Folder Sharing

Share All: + Add - Delete

<input type="checkbox"/>	ID	Folder Name	Folder Path	Media Sharing	Volume	Status	Modify
--	--	--	--	--	--	--	--

Volume Name:

Folder Path: **Browse**

Folder Name:

Enable Authentication

Enable Write Access

Enable Media Sharing

Cancel **OK**

3. Enable the FTP (via Internet)

Select the check box to enable **FTP (via Internet)**, then click **Save**.

Sharing Setting

Network/Media Server Name:

Enable	Access Method	Link	Port
<input checked="" type="checkbox"/>	Media Server	--	--
<input checked="" type="checkbox"/>	Network Neighborhood	\\My-Share	--
<input checked="" type="checkbox"/>	FTP	ftp://192.168.0.1:21	<input type="text" value="21"/>
<input checked="" type="checkbox"/>	FTP(via Internet)	ftp://0.0.0.0:21	21

4. Access Your USB Disk via Internet

Now different clients with Internet connection can access the USB disk:

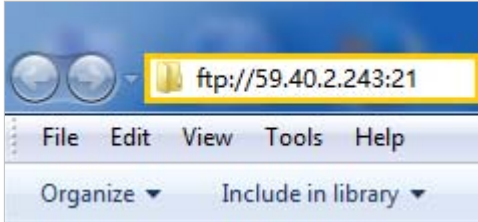
Computer	<ol style="list-style-type: none"> 1) Open the Windows Explorer (or go to Computer, only for Windows users) or open a web browser. 2) Type the server address in the address bar: Type in <code>ftp://<WAN IP address of the router>:<port number></code> (such as <code>ftp://59.40.2.243:21</code>). If you have specified the domain name of the router, you can also type in <code>ftp://<domain name>:<port number></code> (such as <code>ftp://MyDomainName:21</code>)  <p style="text-align: center; color: #0070C0;">The Address Bar of the Windows Explorer (Windows 7)</p> <ol style="list-style-type: none"> 3) Press [Enter] on the keyboard. 4) Access with the username and password you've set in Step 2 Enable Authentication for Data Security. <p>Tips: You can also access the USB disk via a third-party app for network files management, which can resume broken file transfers.</p>
Pad	Use a third-party app for network files management.

 **Tips:**

Refer to [Set Up a Dynamic DNS Service Account](#) to learn how to set up a domain name for you router.

6.2.2. Customize Your Settings

➤ To Only Share Specific Content

By default, [Share All](#) is enabled so all content on the USB disk is shared. If you want to only share specific folders, follow the steps below:

1. Visit <http://tplinkwifi.net>, then log in with the username and password you've set for the router.
2. Go to [Basic](#) > [USB Settings](#) > [Folder Sharing](#). Focus on the section of [Folder Sharing](#). Click the button to disable [Share All](#), then click [Add](#) to add a new sharing folder.
3. Select the [Volume Name](#) and [Folder Path](#), then specify the [Folder Name](#) as you like.
4. Tick [Enable Authentication](#). If you allow network clients to modify this folder, Tick [Enable Write Access](#).

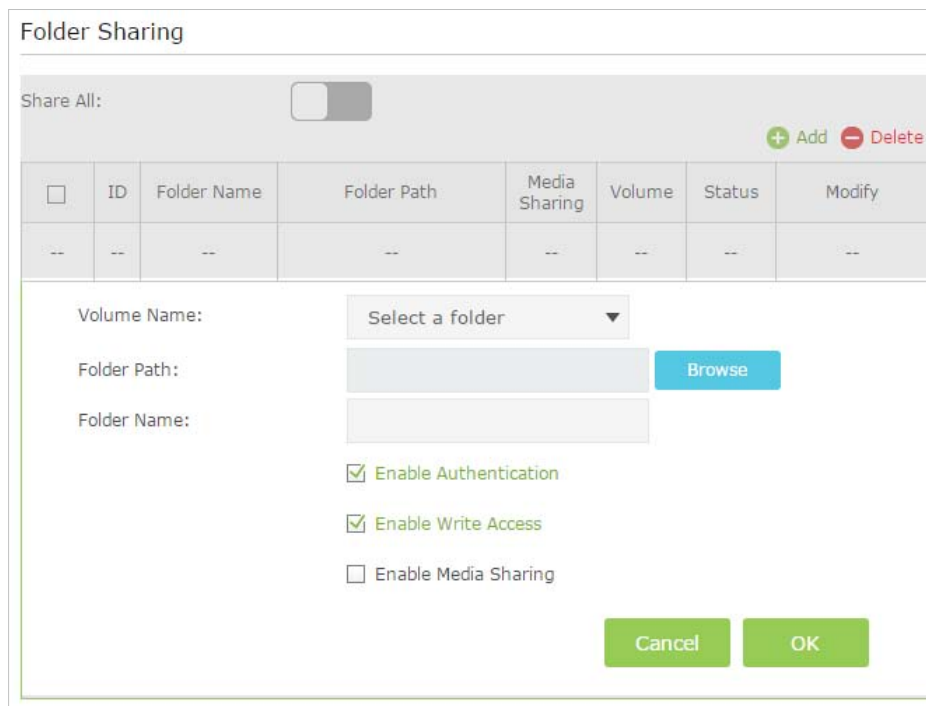

Folder Sharing

Share All:

[+ Add](#) [- Delete](#)

<input type="checkbox"/>	ID	Folder Name	Folder Path	Media Sharing	Volume	Status	Modify
--	--	--	--	--	--	--	--

Volume Name:

Folder Path: [Browse](#)

Folder Name:

[Enable Authentication](#)

[Enable Write Access](#)

[Enable Media Sharing](#)

[Cancel](#) [OK](#)

5. Click [OK](#).

 **Tips:**

The router can share 14 volumes at most. You can click  on the page to detach the corresponding volume you do not need to share.

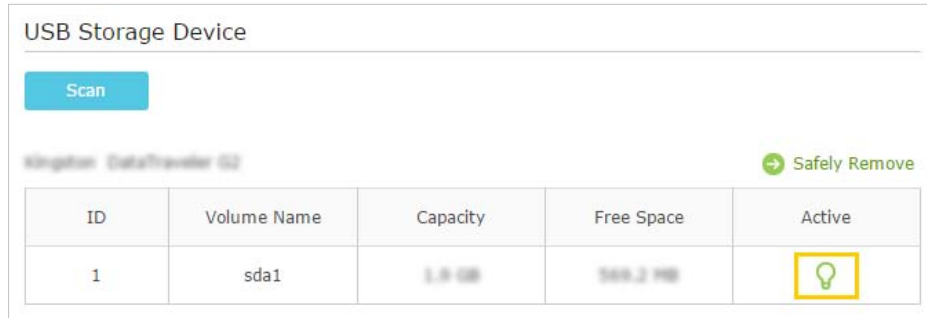

6.3. Media Sharing

The feature of [Media Sharing](#) allows you to view photos, play music and watch movies stored on the USB disk directly from DLNA-supported devices, such as your computer, pad and PS2/3/4.

6.3.1. Access the USB Disk

1. Connect Your USB Disk

Insert your USB storage device into the router's USB port directly or using a USB cable. Wait several seconds until the USB LED becomes solid on.

Tips:

- If you use USB hubs, make sure no more than 4 devices are connected to the router.
- If the USB storage device requires using bundled external power, make sure the external power has been connected.
- If you use a USB hard drive, make sure its file system is FAT32 or NTFS.
- Before you physically disconnect a USB device from the router, safely remove it to avoid data damage: Go to [Advanced](#) > [USB Settings](#) > [Disk Settings](#) and click [Safely Remove](#).

2. Play the Media on Your USB Disk

Now the DLNA-supported devices (such as your computer and pad) connected to the router can detect and play the media files on the USB disks.

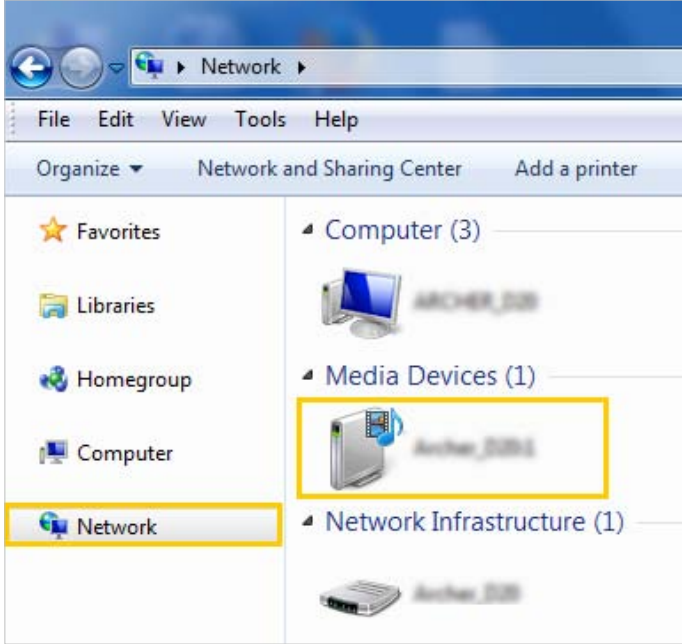
Windows computer	<p>Go to Computer > Network, then click the Media Server Name in the Media Devices section.</p> <p>Note: Here we take Windows 7 as an example.</p>  <p>The screenshot shows the Windows 7 Network folder. The left sidebar has 'Network' selected. The main pane shows a tree view with 'Computer (3)', 'Media Devices (1)', and 'Network Infrastructure (1)'. The 'Media Devices (1)' section is expanded, and a device icon labeled 'Archer_2011' is highlighted with a yellow box.</p>
	Pad

6.3.2. Customize Your Settings

➤ To Only Share Specific Content

By default, **Share All** is enabled so all content on the USB disk is shared. If you want to only share specific folders, follow the steps below:

1. Visit <http://tplinkwifi.net>, then log in with the username and password you've set for the router.
2. Go to **Basic** > **USB Settings** > **Folder Sharing**. Focus on the **Folder Sharing** section.
3. Click the button to disable **Share All**, then click **Add** to add a new sharing folder.
4. Select the **Volume Name** and **Folder Path**, then enter a **Folder Name** as you like.
5. Tick **Enable Media Sharing** and click **OK**.

Folder Sharing

Share All:

+ Add - Delete

☐	ID	Folder Name	Folder Path	Media Sharing	Volume	Status	Modify
--	--	--	--	--	--	--	--

Volume Name: Select a folder ▼

Folder Path: Browse

Folder Name:

Enable Authentication

Enable Write Access

Enable Media Sharing

Cancel
OK

Tips:

The router can share 14 volumes at most. You can click on the page to detach the corresponding volume you do not need to share.

USB Storage Device

Scan

➔ Safely Remove

ID	Volume Name	Capacity	Free Space	Active
1	sda1	1.8 GB	569.2 MB	

6.4. Printer Sharing

The **Printer Sharing** feature helps you share a printer with different computers connected to the router.

Note:

Printers unlisted on this page may be incompatible with the router:

<http://www.tp-link.com/common/compatible/print-server/>.

1. Install the Driver of the Printer

Make sure you have installed the driver of the printer on each computer that needs printer service.

If you do not have the driver, contact the printer manufacturer.

2. Connect the Printer

Cable a printer to the USB port with the USB cable. Wait several seconds until the USB LED becomes solid on.

3. Install the TP-LINK USB Printer Controller Utility

TP-LINK USB Printer Controller Utility helps you access the shared printer. Download and install the utility on each computer that needs printer service.

- 1) Visit <http://www.tp-link.com/app/usb/>.
- 2) Click [PC Utility](#) (for Windows users) or [Mac Utility](#) to download the installation file and uncompress it.



- 3) Open the uncompressed folder, then click [TP-LINK USB Printer Controller Setup](#) (for Windows users) or [TP-Link UDS Printer Controller Installer](#) (for Mac users) to install the utility.

4. Access the Printer

You should set the shared printer as [Auto-Connect Printer](#) on every computer that needs printer service.

- 1) Double-click the icon  on your desktop to launch the USB Printer Controller.
- 2) Highlight the printer you share.

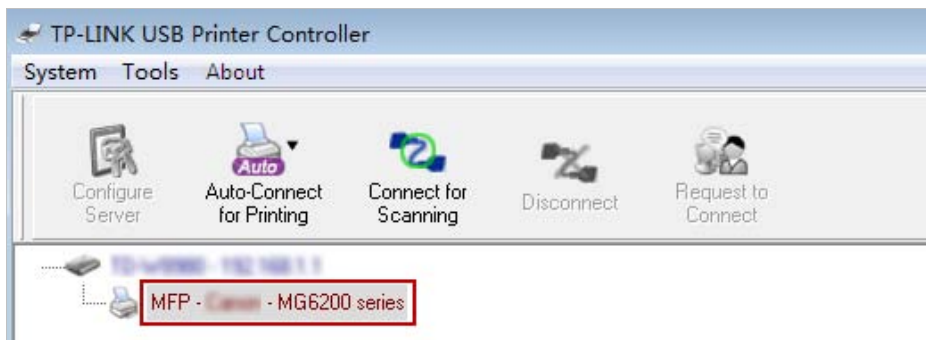

Windows

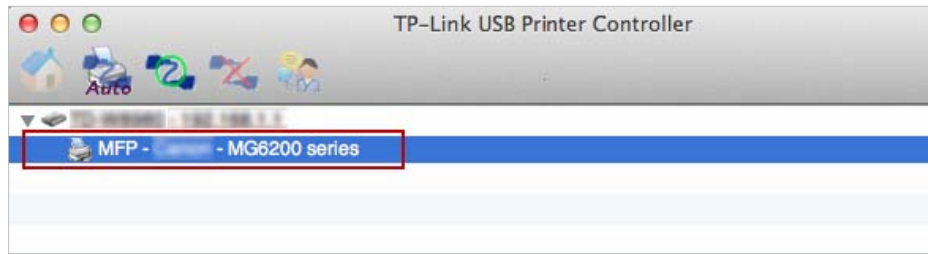

Mac

- 3) Click the [Auto-Connect for printing](#) tab to pull down a list, then select [Set Auto-Connect Printer](#).

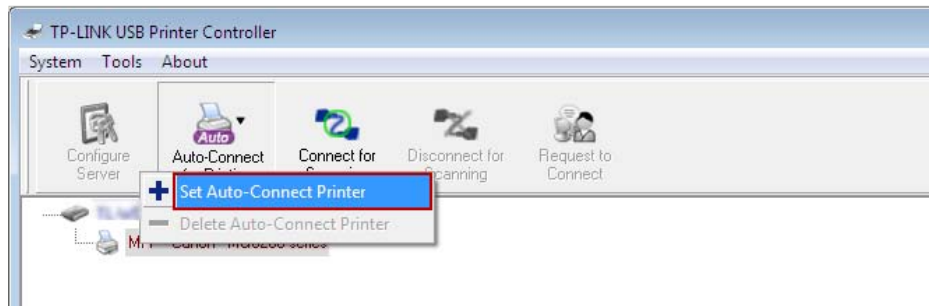

Windows

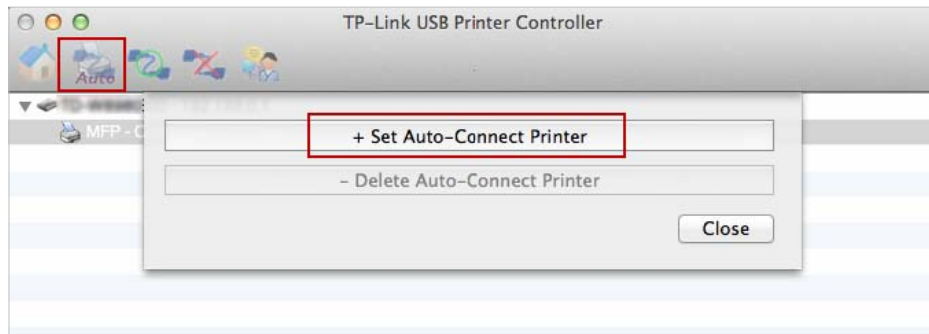

Mac

4) Select the printer you share, then click [Apply](#).

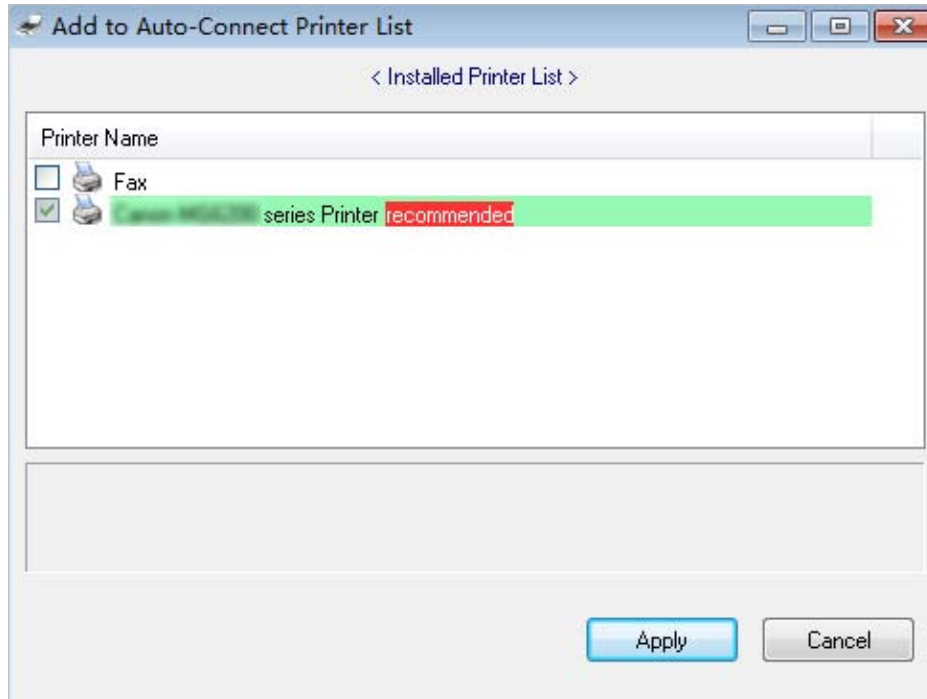

Windows

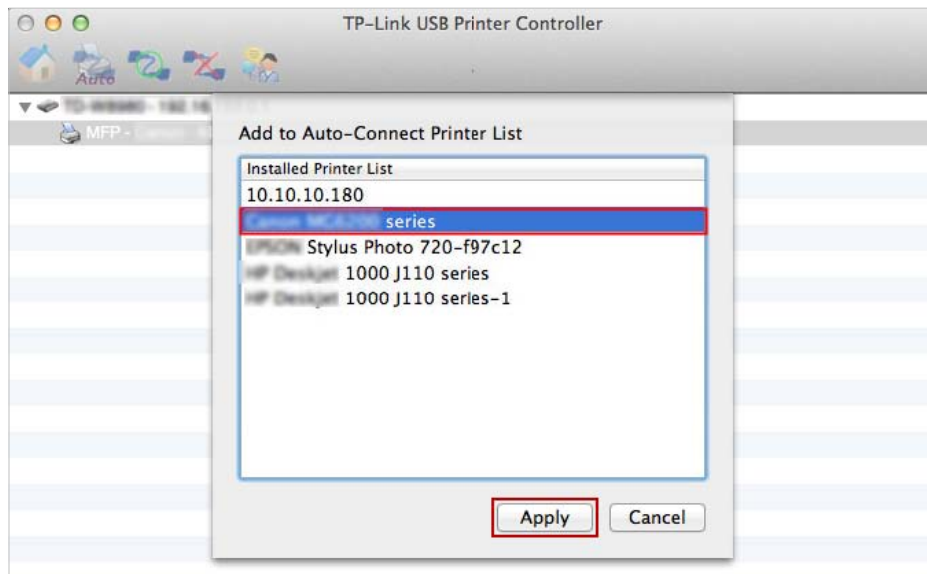

Mac

- 5) You will see the printer marked as **Auto-Connect Printer**. Now you can print with this printer.

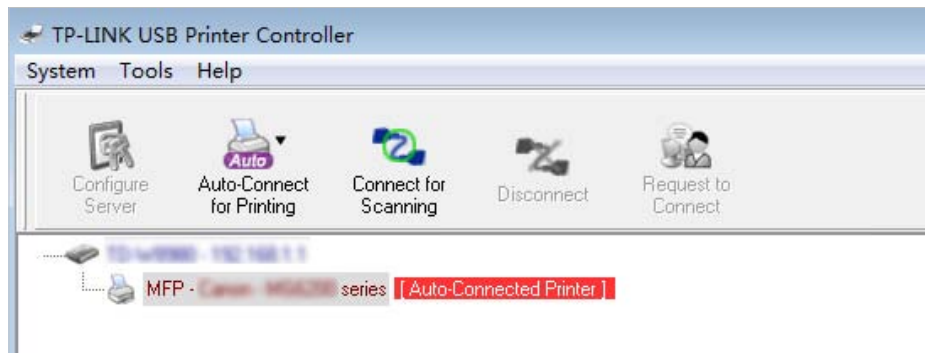

Windows

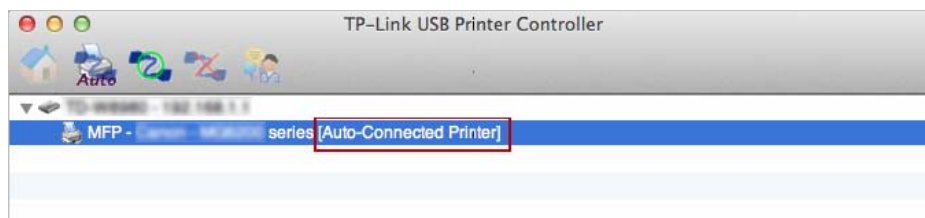

Mac

Tips:

The Print Server also allows different clients to share the scan feature of MFPs (Multi-Function Printers). To scan with **TP-LINK USB Printer Controller**, right-click the printer and select **Network Scanner**. Then, a scanning window will pop up. Finish the scanning process by following the on-screen instructions.

Chapter 7

Parental Control

This function allows you to block inappropriate, explicit and malicious websites, and controls access to specified websites at specified time.

I want to:

Control what types of websites my children or other home network users can visit and even the times of day they are allowed to access the Internet.

For example, I want to allow my children's devices (e.g. a computer or a tablet) to access only www.tp-link.com and Wikipedia.org from 18:00 (6PM) to 22:00 (10PM) at the weekend and not other times.

How can I do that?

1. Visit <http://tplinkwifi.net>, and log in with the username and password you set for the router.
2. Go to [Advanced](#) > [Parental Control](#) and enable [Parental Control](#).

Parental Control

Status:

3. Click [Add](#). And then Click [View Existing Devices](#), and select the access device. Or, input the [Device Name](#) and [MAC Address](#) manually.

Devices Under Parental Control

The Effective Time Schedule is based on the time of the Router. The time can be set in "Advanced -> System Tools -> Time Settings"

Refresh Add Delete

<input type="checkbox"/>	ID	Device Name	MAC Address	Effective Time	Description	Status	Modify
--	--	--	--	--	--	--	--

Device Name: [View Existing Devices](#)

MAC Address:

Effective Time:

Description:

Enable

Cancel OK

4. Click the  icon to set the Internet Access Time. Drag the cursor over the appropriate cell(s) and click **OK**.

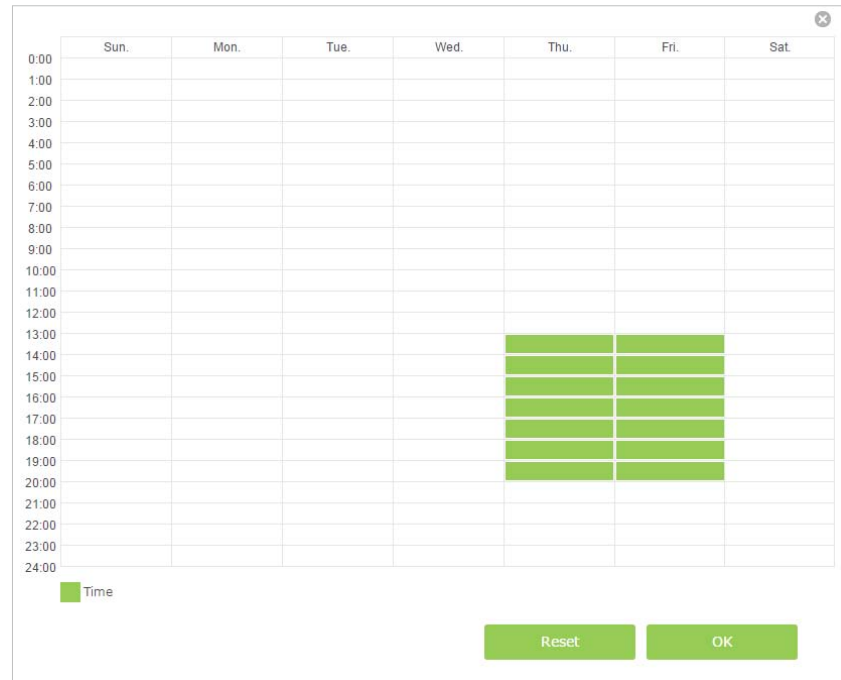

	Sun.	Mon.	Tue.	Wed.	Thu.	Fri.	Sat.
0:00							
1:00							
2:00							
3:00							
4:00							
5:00							
6:00							
7:00							
8:00							
9:00							
10:00							
11:00							
12:00							
13:00							
14:00							
15:00							
16:00							
17:00							
18:00							
19:00							
20:00							
21:00							
22:00							
23:00							
24:00							

Legend: ■ Time

Buttons: **Reset** **OK**

5. Enter a **Description** for the entry. Keep the **Enable** checkbox selected. Click **OK**.
6. Select **Whitelist** as the restriction policy.



Content Restriction

Restriction Blacklist Whitelist

Tips:

- In **Blacklist** mode, the controlled devices cannot access any websites containing the specified keywords during the Internet Access Time period.
 - In **Whitelist** mode, the controlled devices can only access websites containing the specified keywords during the Internet Access Time period.
7. Click  **Add a new keyword** . Enter a keyword or a website and click **Save**.

You can add up to 32 keywords for either Blacklist or Whitelist. Below are some sample entries to allow access.

- Enter a web address (e.g. wikipedia.org) or a web address keyword (e.g. wikipedia) to only allow or block access to the websites containing that keyword.
- Specify the domain suffix (eg. .edu or .org) to allow access only to the websites with that suffix.
- If you wish to block all Internet browsing access, do not add any keyword to the **Whitelist**.

Content Restriction

Restriction Blacklist Whitelist

+ Add a new keyword

Done!

Now you can control your children's Internet access according to your needs.

Chapter 8

Bandwidth Control

The Bandwidth Control feature is used to fully utilize your limit bandwidth and optimize the load respectively. With this feature enabled, you can assign a specific minimum or maximum bandwidth for each computer, thus minimizing the impact caused when the connection is under heavy load.

I want to: Use an independent bandwidth and enjoy a good Internet experience without being affected by other users who are sharing the same router.

For example, my roommate and I share 512Kbps Upstream Bandwidth and 8Mbps Downstream Bandwidth via this router, she likes to watch live show and play online games, which may take up much bandwidth. I don't want to be affected, so we agree to equally distribute the bandwidth. Our IP addresses are 192.168.0.101 and 192.168.0.110.

Tips: To use the bandwidth control feature, you'd better set static IP Address on each computer to be controlled or configure Address reservation on the router in order to manage easily. About how to configure address reservation, please refer to [To reserve an IP address for a specified client device:](#)

How can I do that?

1. Visit <http://tplinkwifi.net>, and log in with the password you set for the router.
2. Go to [Advanced](#) > [Bandwidth Control](#) page.

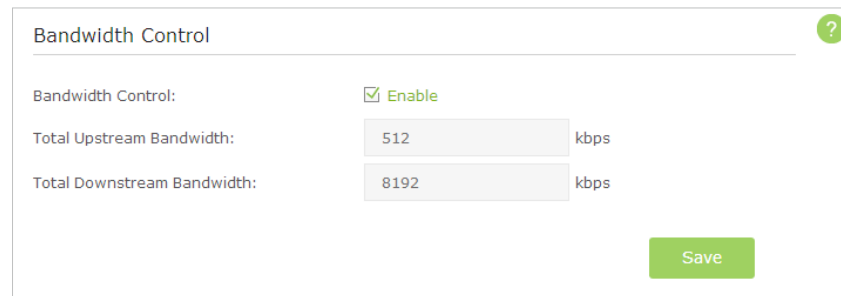

Bandwidth Control

Bandwidth Control: Enable

Total Upstream Bandwidth: kbps

Total Downstream Bandwidth: kbps

Save

3. Enable [Bandwidth Control](#).
4. Enter the [Total Upstream Bandwidth](#) and the [Total Downstream Bandwidth](#) given by your ISP. (1Mbps=1024Kbps). Click [Save](#) to save the settings.
5. Click [Add](#) to add controlling rules for each computer respectively.

Controlling Rules

+ Add - Delete

<input type="checkbox"/>	Description	Priority	Up(min/max)	Down(min/max)	Enable	Modify
--	--	--	--	--	--	--

IP Range: 192.168.0.101 - 192.168.0.101

Port Range: 1 - 65535

Protocol: ALL

Priority: 5 (1 means the highest priority.)

Upstream: 250 to 500









Downstream: 2000 to 4000

Enable this entry

Cancel OK

- 1) **IP Range:** Enter the IP address. The field can be single IP address or IP address range according to your demands. When you configure the single IP address, the computer with this IP address will get independent given bandwidth. When you configure the IP address range, all computers in the range will share the given bandwidth.
- 2) **Port Range:** Keep the default settings. The default port range of TCP protocol or UDP protocol is from 1 to 65535.
- 3) **Protocol:** Keep the default setting. Or you can choose the TCP protocol or UDP protocol or both of them.
- 4) **Priority:** Keep the default setting. You can change the value if you want to first guarantee the bandwidth for one computer. The smaller value has the higher priority.
- 5) **Upstream/Downstream:** Enter the bandwidth according to your division.
- 6) Check to enable this entry and click **OK** to save the settings.

6. Follow the steps above to add a rule for the other computer. And then you will get the following table.

Controlling Rules						
 Add  Delete						
<input type="checkbox"/>	Description	Priority	Up(min/max)	Down(min/max)	Enable	Modify
<input type="checkbox"/>	192.168.0.110	5	250/500 kbps	2000/4000 kbps		 
<input type="checkbox"/>	192.168.0.101	5	250/500 kbps	2000/4000 kbps		 

Done!

Now you and your roommate have an independent bandwidth.

Chapter 9

Network Security

This chapter guides you on how to protect your home network from cyber attacks and unauthorized users by implementing these three network security functions. You can protect your home network against DoS (Denial of Service) attacks from flooding your network with server requests using DoS Protection, block or allow specific client devices to access your network using Access Control, or you can prevent ARP spoofing and ARP attacks using IP & MAC Binding function.

This chapter contains the following sections:

- *Protect the Network from Cyber Attacks*
- *Access Control*
- *IP & MAC Binding*

9.1. Protect the Network from Cyber Attacks

The SPI (Stateful Packet Inspection) Firewall and DoS (Denial of Service) Protection protect the router from cyber attacks.

The SPI Firewall can prevent cyber attacks and validate the traffic that is passing through the router based on the protocol. This function is enabled by default, and it's recommended to keep the default setting.

DoS Protection can protect your home network against DoS attacks from flooding your network with server requests. Follow the steps below to configure DoS Protection.

1. Visit <http://tplinkwifi.net>, and log in with the username and password you set for the router.
2. Go to [Advanced > Security > DDoS](#).

DoS Protection:

ICMP-FLOOD Attack Filtering: Off

UDP-FLOOD Attack Filtering: Off

TCP-SYN-FLOOD Attack Filtering: Off

Forbid Ping Packets From LAN Port

Forbid Ping Packets From WAN Port

Save

Blocked DoS Host List

Refresh Delete

<input type="checkbox"/>	ID	IP Address	MAC Address

3. Enable [DoS Protection](#).
4. Set the level ([Off](#), [Low](#), [Middle](#) or [High](#)) of protection for [ICMP-FLOOD Attack Filtering](#), [UDP-FLOOD Attack Filtering](#) and [TCP-SYN-FLOOD Attack Filtering](#).
 - [ICMP-FLOOD Attack Filtering](#) - Enable to prevent the Internet Control Message Protocol (ICMP) flood attack.
 - [UDP-FLOOD Attack Filtering](#) - Enable to prevent the User Datagram Protocol (UDP) flood attack.
 - [TCP-SYN-FLOOD Attack Filtering](#) - Enable to prevent the Transmission Control Protocol-Synchronize (TCP-SYN) flood attack.

🔗 Tips:

The level of protection is based on the traffic packets number. The protection will be triggered immediately when the number of packets exceeds the preset threshold value (the value can be set on [Advanced > System Tools > System Parameters > DoS Protection Level Settings](#)), and the vicious host will be displayed in the [Blocked DoS Host List](#).

5. Select [Forbid Ping Packets From LAN Port](#) if you want to ignore the ping packets from WAN port.
6. Select [Forbid Ping Packet From LAN Port](#) if you want to ignore the ping packets from LAN port.
7. Click [Save](#) to make the settings effective.

9.2. Access Control

Access Control is used to block or allow specific client devices to access your network (via wired or wireless) based on a list of blocked devices (Blacklist) or a list of allowed devices (Whitelist).

I want to: Block or allow specific client devices to access my network (via wired or wireless).

How can I do that?

1. Visit <http://tplinkwifi.net>, and log in with the username and password you set for the router.
2. Go to [Advanced > Security > Access Control](#).

Access Control ?

Access Control:

Access Mode

Default Access Mode: Blacklist
 Whitelist

[Save](#)

Devices in Blacklist

[+ Add](#) [- Delete](#)

<input type="checkbox"/>	ID	Device Name	MAC Address	Modify
--	--	--	--	--

Devices Online

[Refresh](#) [Bind](#)

<input type="checkbox"/>	ID	Device Name	IP Address	MAC Address	Connection Type
<input type="checkbox"/>	1	Unknown	192.168.0.123	00:0A:EE:14:78:00	Wired
<input type="checkbox"/>	2	ARCHER_C2-DNA	192.168.0.133	00:0A:EE:C2:02:38	Wired

3. Enable [Access Control](#).
4. Select the access mode to either block (recommended) or allow the device(s) in the list.

To block specific device(s)

- 1) Select [Blacklist](#) and click [Save](#).
- 2) Select the device(s) to be blocked in the [Devices Online](#) table.
- 3) Click [Block](#) above the [Devices Online](#) table. The selected devices will be added to [Devices in Blacklist](#) automatically.

To allow specific device(s)

- 1) Select [Whitelist](#) and click [Save](#).
- 2) Click [Add](#).

Devices in Whitelist				
+ Add - Delete				
<input type="checkbox"/>	ID	Device Name	MAC Address	Modify
<input type="checkbox"/>	--	--	--	--

Device Name:	<input type="text"/>
MAC Address:	<input type="text"/>

<input type="checkbox"/>	1	Unknown	50:E5:49:1E:06:80	<input type="button" value="Edit"/> <input type="button" value="Delete"/>
--------------------------	---	---------	-------------------	---

- 3) Enter the [Device Name](#) and [MAC Address](#) (You can copy and paste the information from the following list if the device is connected to your network).
- 4) Click [OK](#).

Done!

Now you can block or allow specific client devices to access your network (via wired or wireless) using the [Blacklist](#) or [Whitelist](#).

9.3. IP & MAC Binding

IP & MAC Binding, namely, ARP (Address Resolution Protocol) Binding, is used to bind network device's IP address to its MAC address. This will prevent ARP Spoofing and other ARP attacks by denying network access to an device with matching IP address in the Binding list, but unrecognized MAC address.

I want to:

Prevent ARP spoofing and ARP attacks.

How can I do that?

1. Visit <http://tplinkwifi.net>, and log in with the username and password you set for the router.
2. Go to [Advanced](#) > [Security](#) > [IP & MAC Binding](#).

Settings

IP & MAC Binding

Binding List

[+ Add](#) [- Delete](#)

<input type="checkbox"/>	ID	MAC Address	IP Address	Status	Enable	Modify
<input type="checkbox"/>	--	--	--	--	--	--

ARP List

[Refresh](#) [Bind](#)

<input type="checkbox"/>	ID	Device Name	MAC Address	IP Address	Bound	Modify
<input type="checkbox"/>	1	TP-SHARE	00:0A:EB:13:7B:00	192.168.0.88	Unloaded	
<input type="checkbox"/>	2	ARCHER_C2-SHARE	00:0A:EB:C2:02:38	192.168.0.133	Unloaded	
<input type="checkbox"/>	3	Unknown	00:0A:EB:14:7B:00	192.168.0.123	Unloaded	
<input type="checkbox"/>	4	Unknown	50:E5:49:1E:06:80	192.168.0.200	Unloaded	

3. Enable [IP & MAC Binding](#).
4. Bind your device(s) according to your need.

To bind the connected device(s)

- 1) Select the device(s) to be bound in the [ARP List](#).
- 2) Click [Bind](#) to add to the [Binding List](#).

To bind the unconnected device

- 1) Click [Add](#).

[+ Add](#) [- Delete](#)

<input type="checkbox"/>	ID	MAC Address	IP Address	Status	Enable	Modify
<input type="checkbox"/>	--	--	--	--	--	--

MAC Address:

IP Address:

Enable

[Cancel](#) [OK](#)

- 2) Enter the [MAC address](#) and [IP address](#) that you want to bind.

3) Select the checkbox to enable the entry and click [OK](#).

Done!

Now you don't need to worry about ARP spoofing and ARP attacks.

Chapter 10

NAT Forwarding

Router's NAT (Network Address Translation) feature makes the devices in the LAN use the same public IP address to communicate in the Internet, which protects the local network by hiding IP addresses of the devices. However, it also brings about the problem that external host cannot initiatively communicate with the specified device in the local network.

With forwarding feature the router can penetrate the isolation of NAT and allows the external hosts in the Internet to initiatively communicate with the devices in the local network, thus to realize some special functions.

TP-LINK router includes four forwarding rules. If two or more rules are set, the priority of implementation from high to low is Virtual Servers, Port Triggering, UPnP and DMZ.

This chapter contains the following sections:

- *Share Local Resources in the Internet by Virtual Server*
- *Open Ports Dynamically by Port Triggering*
- *Make Applications Free from Port Restriction by DMZ*
- *Make Xbox Online Games Run Smoothly by UPnP*

10.1. Share Local Resources in the Internet by Virtual Server

When you build up a server in the local network and want to share it on the Internet, Virtual Server can realize the service and provide it to the Internet users. At the same time virtual server can keep the local network safe as other services are still invisible from the Internet.

Virtual server can be used for setting up public services in your local network, such as HTTP, FTP, DNS, POP3/SMTP and Telnet. Different service uses different service port. Port 80 is used in HTTP service, port 21 in FTP service, port 25 in SMTP service and port 110 in POP3 service. Please verify the service port number before the configuration.

I want to: share my personal website I've built in local network with my friends through the Internet.

For example, the personal website has been built in my home PC (192.168.0.100). I hope that my friends in the Internet can visit my website in some way. The PC is connected to the router with the WAN IP address 218.18.232.154.

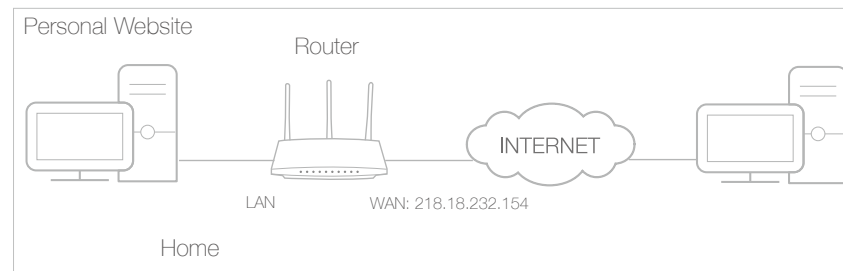

How can I do that?

1. Assign a static IP address to your PC, for example 192.168.0.100.
2. Visit <http://tplinkwifi.net>, and log in with the password you set for the router.
3. Go to *Advanced* > *NAT Forwarding* > *Virtual Servers*, click *Add*.

Virtual Servers

+ Add - Delete

<input type="checkbox"/>	ID	Service Type	External Port	Internal IP	Internal Port	Protocol	Status	Modify
--	--	--	--	--	--	--	--	--

Service Name: HTTP View Existing Applications

External Port: 80 (XX-XX or XX)

Internal IP: 192.168.0.100

Internal Port: 80 (XX or Blank, 1-65535)

Protocol: TCP

Enable this Entry

Cancel OK

4. Click *View Existing Services*, and choose *HTTP*. The external port, internal port and protocol will be automatically filled with contents. Enter the PC's IP address 192.168.0.100 in the *Internal IP* field.
5. Click *OK* to save the settings.

☞ Tips:

1. It is recommended to keep the default settings of *Internal Port* and *Protocol* if you are not clear about which port and protocol to use.
2. If the service you want to use is not in the *Service Type*, you can enter the corresponding parameters manually. You should verify the port number that the service need.
3. You can add multiple virtual server rules if you want to provide several services in a router. Please note that the *External Port* cannot be overlapped.

Done!

Users in the Internet can enter [http:// WAN IP](http://WAN IP) (in this example: [http:// 218.18.232.154](http://218.18.232.154)) to visit your personal website.

☞ Tips:

1. WAN IP should be a public IP address. For the WAN IP is assigned dynamically by ISP, it is recommended to apply and register a domain name for the WAN by DDNS, go to *Set Up a Dynamic DNS Service Account* for more information. Then you can use <http://domain name> to visit the website.
2. If you have changed the default *External Port*, you should use [http:// WAN IP: External Port](http://WAN IP: External Port) or [http:// domain name: External Port](http://domain name: External Port) to visit the website.

10.2. Open Ports Dynamically by Port Triggering

Port triggering can specify a triggering port and its corresponding external ports. When a host in the local network initiates a connection to the triggering port, all the external ports will be opened for subsequent connections. The router can record the IP address of the host. When the data from the Internet return to the external ports, the router can forward them to the corresponding host. Port triggering is mainly applied to online games, VoIPs and video players. Common applications include MSN Gaming Zone, Dialpad and Quick Time 4 players, etc.

Follow the steps below to configure the port triggering rules:

1. Visit <http://tplinkwifi.net>, and log in with the password you set for the router.
2. Go to *Advanced* > *NAT Forwarding* > *Port Triggering* and click *Add*.

The screenshot shows the 'Port Triggering' configuration page. At the top, there are '+ Add' and '- Delete' buttons. Below is a table with the following columns: ID, Application, Triggering Port, Triggering Protocol, External Port, External Protocol, Status, and Modify. The table is currently empty. Below the table, there are several input fields:

- Application: MSN Gaming Zone (with a 'View Existing Applications' button)
- Triggering port: 47624 (with a '(XX)' label)
- Triggering protocol: TCP (dropdown menu)
- External Port: 2300-2400,28800-29000 (with a '(XX or XX-XX or XX,XX-XX)' label)
- External Protocol: TCP (dropdown menu)

 At the bottom, there is a checked checkbox labeled 'Enable this Entry' and two buttons: 'Cancel' and 'OK'.

3. Click *View Existing Applications*, and select the desired application. The triggering port and protocol, the external port and protocol will be automatically filled with contents. Here we take application *MSN Gaming Zone* as an example.
4. Click *OK* to save the settings.

🔗 Tips:

1. You can add multiple port triggering rules according to your network need.
2. The external ports of different rules cannot be overlapped.
3. One rule can only be used by one host at one time. Other hosts' request at the same time will be rejected.
4. At any time, one host can only use one Port Triggering rule.
5. If the application you need is not listed in the *Existing Applications* list, please enter the parameters manually. You should verify the external ports the application uses first and enter them into *External Port* field according to the format the page displays.

10.3. Make Applications Free from Port Restriction by DMZ

When a PC is set to be a DMZ (Demilitarized Zone) host in the local network, it is totally exposed to the Internet, which can realize the unlimited bidirectional communication between internal hosts and external hosts. The DMZ host becomes a virtual server with all ports opened. When you are not clear about which ports to open in some special applications, like IP camera and database software, you can set the PC to be a DMZ host.

Note:

DMZ is more applicable in the situation that users are not clear about which ports to open. When it is enabled, the DMZ host is totally exposed to the Internet, which may bring some potential safety hazard. If DMZ is not in use, please disable it in time.

I want to: make the home PC join the Internet online game without port restriction.

For example, Due to some port restriction, when playing the online games, you can login normally but cannot join a team with other players. To solve this problem, set your PC as a DMZ with all ports opened.

How can I do that?

1. Assign a static IP address to your PC, for example 192.168.0.100.
2. Visit <http://tplinkwifi.net>, and log in with the password you set for the router.
3. Go to *Advanced* > *NAT Forwarding* > *DMZ* and select the checkbox to enable DMZ.

4. Enter the IP address 192.168.0.100 in the *DMZ Host IP Address* field.
5. Click *Save* to save the settings.

Done!

The configuration is completed. You've set your PC to a DMZ host and now you can make a team to game with other players.

10.4. Make Xbox Online Games Run Smoothly by UPnP

UPnP (Universal Plug and Play) protocol allows the applications or host devices to automatically find the front-end NAT device and send request to it to open the corresponding ports. With UPnP enabled, the applications or host devices in the both sides of NAT device can freely communicate with each other realizing the seamless connection of the network. You may need to enable the UPnP if you want to use applications for multiplayer gaming, peer-to-peer connections, real-time communication (such as VoIP or telephone conference) or remote assistance, etc.

☛ Tips:

1. UPnP is enabled by default in this router.
2. Only the application supporting UPnP protocol can use this feature.
3. UPnP feature needs the support of operating system (e.g. Windows Vista/ Windows 7/ Windows 8, etc. Some of operating system need to install the UPnP components).

For example, When you connect your Xbox to the router which has connected to the Internet to play online games, UPnP will send request to the router to open the corresponding ports allowing the following data penetrating the NAT to transmit. Therefore, you can play Xbox online games without a hitch.

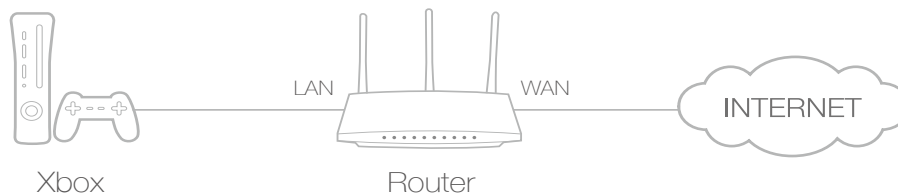

If necessary, you can follow the steps to change the status of UPnP.

1. Visit <http://tplinkwifi.net>, and log in with the password you set for the router;
2. Go to **Advanced > NAT Forwarding > UPnP** and toggle on or off according to your needs.

UPnP

UPnP:

UPnP Service List

Client Number: 0 🔄 Refresh

ID	Service Description	External Port	Protocol	Internal IP Address	Internal Port
--	--	--	--	--	--

Chapter 11

Customize Your Network Settings

This chapter guides you on how to configure advanced networking features that are available for this router.

This chapter contains the following sections:

- *Change the LAN Settings*
- *Configure to Support IPTV Service*
- *Specify DHCP Server Settings*
- *Set Up a Dynamic DNS Service Account*
- *Create Static Routes*
- *Specify Wireless Settings*
- *Use WPS for Wireless Connection*
- *Schedule Your Wireless Function*

11.1. Change the LAN Settings

The router is preset with a default LAN IP 192.168.0.1, which you can use to log in to its web-based management page. The LAN IP address together with the Subnet Mask also defines the subnet that the connected devices are on. If the IP address conflicts with another device on your local network or your network requires a specific IP subnet, you can change it.

1. Visit <http://tplinkwifi.net>, and log in with the username and password you set for the router.
2. Go to [Advanced](#) > [Network](#) > [LAN Settings](#) page.
3. Type in a new IP Address appropriate to your needs.

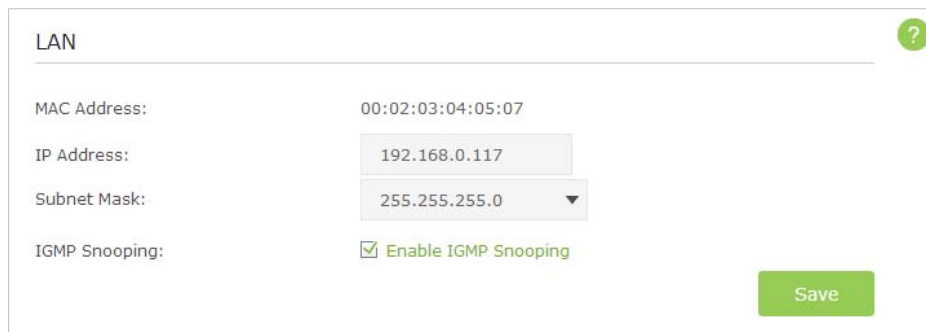

LAN

MAC Address: 00:02:03:04:05:07

IP Address: 192.168.0.117

Subnet Mask: 255.255.255.0

IGMP Snooping: Enable IGMP Snooping

Save

4. Leave the [Subnet Mask](#) as the default settings.
5. Keep IGMP Snooping as enabled by default. IGMP Snooping is the process of listening to IGMP (Internet Group Management Protocol) network traffic. The function prevents hosts on a local network from receiving traffic for a multicast group they have not explicitly joined.
6. Click [Save](#).

Note:

If you have set the Virtual Server, DMZ or DHCP address reservation, and the new LAN IP address is not in the same subnet with the old one, then you should reconfigure them.

11.2. Configure to Support IPTV Service

IPTV is the abbreviation of Internet Protocol Television. The service can only be delivered through the Internet, and our router provides a specific LAN port for IPTV.

By automatically separating IPTV from Internet surfing, we guarantee you a high quality of video streaming and a high speed of Internet surfing.

I want to: Configure the router to enable Internet Protocol Television (IPTV) Services.

For example, I already bought IPTV service, but this service can only be delivered through the Internet. Therefore, I need to configure my router first.

How can I do that?

1. Visit <http://tplinkwifi.net>, and log in with the username and password you set for the router.
2. Go to [Advanced](#) > [Network](#) > [IPTV](#) to open the configuration page.
3. Configure IPTV settings:

The screenshot shows the 'IPTV Settings' configuration page. It includes the following fields and values:

- IPTV:** Enable IPTV
- Mode:** Bridge
- IGMP Proxy:** V3
- LAN1:** IPTV
- LAN2:** Internet
- LAN3:** Internet
- LAN4:** Internet

A green 'Save' button is located at the bottom right of the configuration area.

- 1) Select the [Enable IPTV](#) check box.
- 2) Select the appropriate [Mode](#) according to your ISP. Select [Bridge](#) if your ISP is not listed and no other parameters are required, and then skip to substep 4. Select [Custom](#) if your ISP is not listed but provides necessary parameters.
- 3) After you have selected a mode, the necessary parameters are predetermined. You can perform other configuration, e.g. enter the [IPTV Multicast VLAN ID](#) and select the [IPTV Multicast VLAN Priority](#) in [Russia](#) mode according to your ISP.
- 4) select the [IGMP Proxy](#) version, either V2 or V3, according to the information provided by your ISP.
- 5) For [Russia](#), [Singapore-ExStream](#), [Malaysia-Unifi](#) and [Malaysia-Maxis](#) mode, connect device to the predetermined LAN port. For [Bridge](#) and [Custom](#) mode, select a LAN port as the IPTV port and connect the set-top box to the corresponding port.
- 6) Click [Save](#).

Done!

Your IPTV setup is done now! You may need other configurations

on your set-top box before enjoying your TV.

11.3. Specify DHCP Server Settings

By default, the DHCP (Dynamic Host Configuration Protocol) Server is enabled and the router acts as a DHCP server; it dynamically assigns TCP/IP parameters to client devices from the IP Address Pool. You can change the settings of DHCP Server if necessary, and you can reserve LAN IP address for specified client device.

1. Visit <http://tplinkwifi.net>, and log in with the username and password you set for the router.
2. Go to [Advanced](#) > [Network](#) > [DHCP Server](#).

■ **Note:**

1. The router can be configured to work as a [DHCP Relay](#). A DHCP relay is a computer that forwards DHCP data between computers that request IP addresses and the DHCP server that assigns the addresses. Each of the device's interfaces can be configured as a DHCP relay. If it is enabled, the DHCP requests from local PCs will be forwarded to the DHCP server that runs on WAN side.

➤ **To specify the IP address that the router assigns:**

1. Make sure that the [Enable DHCP Server](#) checkbox is selected.
2. Enter the starting and ending IP address in the [IP Address Pool](#).
3. Enter other parameters if the ISP offers, the Default Gateway is automatically filled the same as the LAN IP address of the router.
4. Click [Save](#) to make the settings effective.

➤ **To reserve an IP address for a specified client device:**

1. Click the [Add](#) button.

2. Enter the MAC address of the device for which you want to reserve IP address.
3. Specify the IP address which will be reserved by the router.
4. Check to [Enable this entry](#) and click [OK](#) to make the settings effective.

Note:

You can also appoint IP addresses within a specified range to devices of the same type by using [Condition Pool](#) feature. For example, you can assign IP addresses within the range (192.168.0.50 to 192.168.0.80) to Camera devices, thus facilitating the network management.

11.4. Set Up a Dynamic DNS Service Account

Most ISPs (Internet service providers) assign a dynamic IP address to the router and you can use this IP address to access your router remotely. However, the IP address can change any time and you don't know when it changes. In this case, you might need the DDNS (Dynamic Domain Name Server) feature on the router to allow you and your friends to access your router and local servers (FTP, HTTP, etc.) using domain name, in no need of checking and remembering the IP address (such as 192.168.0.x) to the router.

Note:

DDNS does not work if the ISP assigns a private WAN IP address (such as 192.168.1.x) to the router.

To set up DDNS, please follow the instructions below:

1. Visit <http://tplinkwifi.net>, and log in with the username and password you set for the router.
2. Go to [Advanced](#) > [Network](#) > [Dynamic DNS](#).
3. Select the [DDNS service provider](#) (NO-IP or DynDNS). If you don't have a DDNS account, select a service provider and click [Go to register](#).

Dynamic DNS Settings

Service Provider: Dyndns NO-IP [Go to register..](#)

Username:

Password:

Domain Name:

Disconnected

4. Enter the username, password and domain name of the account (such as lisadns.ddns.net).

5. Click [Login](#) and click [Save](#).

Tips:

If you want to use a new DDNS account, please [Logout](#) first, then login with the new account.

11.5. Create Static Routes

Static routing is a form of routing that is configured manually by a network administrator or a user by adding entries into a routing table. The manually-configured routing information guides the router in forwarding data packets to the specific destination.

I want to:

Visit multiple networks and multiple servers at the same time.

[For example](#), in a small office, my PC can surf the Internet, but I also want to visit my company's network. Now I have a switch and another router. I connect the devices as shown in the following figure so that the physical connection between my PC and my company's server is achieved. To surf the Internet and visit my company's network at the same time, I need to configure the static routing.

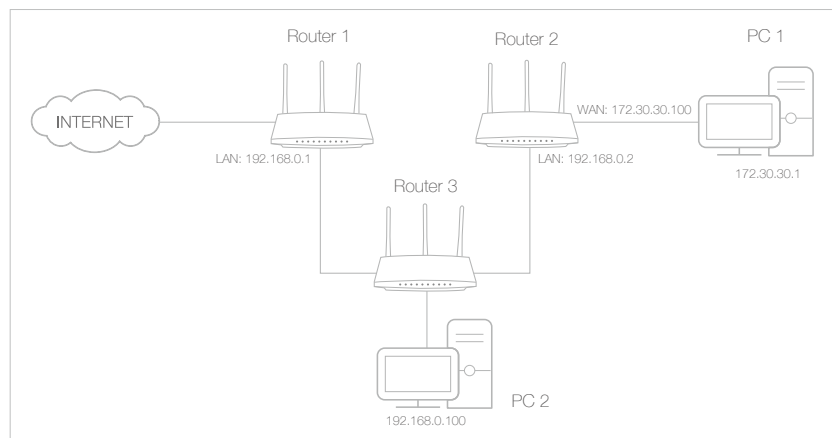

How can I do that?

1. Change the router's LAN IP addresses to two different IP addresses on the same subnet. Disable Router 2's DHCP function.
2. Visit <http://tplinkwifi.net>, and log in with the username and password you set for the router.
3. Go to *Advanced* > *Network* > *Advanced Routing*.
4. Click [Add](#) to add a new static routing entry.

<input type="checkbox"/>	ID	Destination IP	Subnet Mask	Gateway	Enable	Modify
--	--	--	--	--	--	--

5. Finish the settings according to the following explanations:

Destination IP Address: 172.30.30.1

Subnet Mask: 255.255.255.255

Gateway: 192.168.0.2

Interface: LAN & WLAN

Status: Enabled

Cancel OK

Destination IP: The destination IP address that you want to assign to a static route. This IP address cannot be on the same subnet with the WAN IP or LAN IP of the router. In the example, the IP address of the company network is the destination IP address, so here enters 172.30.30.1.

Subnet Mask: Determines the destination network with the destination IP address. If the destination is a single IP address, enter 255.255.255.255; otherwise, enter the subnet mask of the corresponding network IP. In the example, the destination network is a single IP, so here enters 255.255.255.255.

Gateway: The IP address of the gateway device to which the data packets will be sent. This IP address must be on the same subnet

with the router's IP which sends out the data. In the example, the data packets will be sent to the LAN port of Router 2 and then to the Server, so the default gateway should be 192.168.0.2.

Interface: Determined by the port (WAN/LAN) that sends out the data packets. In the example, the data is sent to the gateway through the LAN port, so LAN should be selected.

Status: Determines the status of the entry. In the example, Enabled should be selected.

6. Click **OK** to save the settings.
7. Check the **System Routing Table** below. If you can find the entry you set in the **System Routing Table**, the static routing is set successfully.

System Routing Table				
ID	Destination Network	Subnet Mask	Gateway	Interface
1	172.30.30.1	255.255.255.255	192.168.0.2	LAN & WLAN
2	192.168.2.0	255.255.255.0	0.0.0.0	LAN & WLAN
3	192.168.0.0	255.255.255.0	0.0.0.0	LAN & WLAN

Done!

Open a web browser on your PC. Enter the company server's IP address to visit the company network.

11.6. Specify Wireless Settings

The router's wireless network name (SSID) and password, and security option are preset in the factory. The preset SSID and password can be found on the product label. You can customize the wireless settings according to your needs.

1. Visit <http://tplinkwifi.net>, and log in with the username and password you set for the router.
2. Go to **Basic > Wireless**.

Wireless Settings

Wireless 2.4GHz: Enable Wireless Radio

Wireless Network Name (SSID): Hide SSID

Password:

Wireless 5GHz: Enable Wireless Radio

Wireless Network Name (SSID): Hide SSID

Password:

Save

➤ **To enable or disable the wireless function of 2.4GHz or 5GHz:**

The wireless radio is enabled by default, if you want to disable the wireless function of the router, just clear the [Enable Wireless Radio](#) checkbox. In this case, all the wireless settings will be invalid.

➤ **To change the wireless network name (SSID) and wireless password of 2.4GHz or 5GHz:**

Create a new SSID in [Wireless Network Name \(SSID\)](#) and customize the password for the network in [Password](#). The default SSID is TP-LINK_XXXX for 2.4GHz, TP-LINK_XXXX_5G for 5GHz, and the value is case-sensitive.

■ **Note:**

If you use a wireless device to change the wireless settings, you will be disconnected when the settings are effective. Please write down the new SSID and password for future use.

➤ **To hide SSID of 2.4GHz or 5GHz:**

Select [Hide SSID](#), and your SSID will not broadcast. Your SSID won't display when you scan for local wireless network list on your wireless device and you need to manually join the network.

➤ **To change the security option:**

1. Go to [Advanced](#) > [Wireless](#) > [Wireless Settings](#).

Wireless Settings 2.4GHz | 5GHz ?

Wireless Radio: Enable Wireless Radio

Wireless Network Name (SSID): Hide SSID

Security: ▼

Version: Auto WPA2-PSK

Encryption: Auto TKIP AES

Password:

Mode: ▼

Channel: ▼

Channel Width: ▼

Transmit Power: Low Middle High

2. Select the wireless network [2.4GHz](#) or [5GHz](#).
3. Select an option from the [Security](#) dropdown list. The router provides four security options, No Security, WPA/WPA2 - Personal (Recommended), WPA/WPA2 - Enterprise and WEP. We recommend you don't change the default settings unless necessary. If you select other options, configure the related parameters according to the help page.

In addition

- [Mode](#) - Select a transmission mode according to your wireless client devices. [802.11b/g/n mixed](#), [802.11g/n mixed](#) or [802.11n only](#) for [2.4GHz](#); and [802.11a/n/ac mixed](#), [802.11n/ac mixed](#) or [802.11ac only](#) for [5GHz](#). It is recommended to just leave it as default.
- [Channel Width](#) - Select a channel width (bandwidth) for the wireless network.
- [Channel](#) - Select an operating channel for the wireless network. It is recommended to leave the channel to [Auto](#), if you are not experiencing the intermittent wireless connection issue.
- [Transmit Power](#) - Select either [High](#), [Middle](#) or [Low](#) to specify the data transmit power. The default and recommended setting is [High](#).

11.7. Use WPS for Wireless Connection

Wi-Fi Protected Setup(WPS) gives consumers an easier approach to set up a security-protected Wi-Fi connection.

1. Visit <http://tplinkwifi.net>, and log in with the username and password you set for the router.

2. Go to *Advanced* > *Wireless* > *WPS* .

11.7.1. Set the Router's PIN

Router's PIN is enabled by default to allow wireless devices to connect to the router using the PIN. You can use the default one or generate a new one.

Note:

PIN (Personal Identification Number) is an eight-character identification number preset to each router. WPS supported devices can connect to your router with the PIN. The default PIN is labeled on the bottom of the router.

11.7.2. Use the WPS Wizard for Wi-Fi Connections

1. Select a setup method:

- **Push Button(Recommended):** Click the [Connect](#) button on the screen. Within two minutes, push the WPS button on the client device.

- **PIN:** Enter the client's PIN, and click [Connect](#).

Success will appear on the above screen and the WPS LED on the router will keep on for five minutes if the client has been successfully added to the network.

11.8. Schedule Your Wireless Function

You can automatically turn off your wireless network (both 2.4GHz and 5GHz) at time when you do not need the wireless connection.

1. Visit <http://tplinkwifi.net>, and log in with the password you set for the router.
2. Go to [Advanced](#) > [Wireless](#) > [Wireless Schedule](#) page.
3. Select the 2.4GHz wireless network to configure. Toggle on the button to enable the Wireless Schedule feature.

Task Schedule 2.4GHz | 5GHz

Wireless Schedule:

	Sun	Mon	Tue	Wed	Thu	Fri	Sat
0:00							
1:00							
2:00							
3:00							
4:00							
5:00							
6:00							
7:00							
8:00							
9:00							
10:00							
11:00							
12:00							
13:00							
14:00							
15:00							
16:00							
17:00							
18:00							
19:00							
20:00							
21:00							
22:00							
23:00							
24:00							

Wi-Fi Off

4. Set the time. Drag the cursor to cover the time area and click [Save](#) to make the settings effective. The selected time will be in red.
5. Repeat steps 3 and 4 to set time for 5GHz wireless network.

■ **Note:**

1. If you just set time for one wireless band, the other wireless band is still always on, so set time for both of the two bands to schedule your whole wireless network.
2. The wireless LED (2.4GHz , 5GHz) will turn off if the corresponding wireless network is disabled.
3. The wireless network will be automatically turned on after the time period you set.

Chapter 12

Manage the Router

This chapter will show you the configuration for managing and maintaining your router.

This chapter includes the following sections:

- *Set Up System Time*
- *Test the Network Connectivity*
- *Upgrade the Firmware*
- *Backup and Restore Configuration Settings*
- *Change the Administrator Account*
- *Local Management*
- *Remote Management*
- *System Log*
- *SNMP Settings*
- *Monitor the Internet Traffic Statistics*

12.1. Set Up System Time

System time is the time displayed while the router is running. The system time you configure here will be used for other time-based functions like Parental Controls. You can manually set how to get the system time.

Visit <http://tplinkwifi.net>, and log in with the username and password you set for the router. Go to *Advanced* > *System Tools* > *Time Settings*.

➤ **To automatically synchronize the time:**

1. In the *Set the Time* field, select *Get automatically from the Internet*.



Time Settings

Current time: 01/01/2000 02:52:58

Set the time: Get automatically from the Internet Manually

Time Zone: (GMT-08:00) Pacific Time (US & Canada); Tijuana

NTP Server I: 0.0.0.0 (optional)

NTP Server II: 0.0.0.0 (optional)

Obtain

Save

2. Select your local *Time Zone* from the drop-down menu.
3. In the *NTP Server I* field, enter the IP address or domain name of your desired NTP Server. (Optional)
4. In the *NTP Server II* field, enter the IP address or domain name of the second NTP Server. (Optional)
5. Click *Obtion*.
6. Click *Save* to make the settings effective.

➤ **To manually set the date and time:**

1. In the *Set Time* field, select *Manually*.

Time Settings

Current time: 01/01/2000 02:52:58

Set the time: Get automatically from the Internet Manually

Date: (MM/DD/YY)

Time: : :

2. Set the current **Date** (In **MM/DD/YYYY** format).
3. Set the current **Time** (In **HH/MM/SS** format).
4. Click **Save** to make the settings effective.

➤ **To set up Daylight Saving Time:**

1. Select **Enable Daylight Saving Time**.

Daylight Saving

Daylight Saving: Enable Daylight Saving

Start: M W T

End: M W T

2. Select the correct **Start** date and time when daylight saving time starts at your local time zone.
3. Select the correct **End** date and time when daylight saving time ends at your local time zone.
4. Click **Save** to make the settings effective.

12.2. Test the Network Connectivity

Diagnostics is used to test the connectivity between the router and the host or other network devices.

1. Visit <http://tplinkwifi.net>, and log in with the username and password you set for the router.
2. Go to **Advanced > System Tools > Diagnostics**.

3. Enter the information with the help of page tips:

- 1) Choose **Ping** or **Traceroute** as the diagnostic tool to test the connectivity;
 - **Ping** is used to test the connectivity between the router and the tested host, and measure the round-trip time.
 - **Traceroute** is used to display the route (path) your router has passed to reach the tested host, and measure transit delays of packets across an Internet Protocol network.
- 2) Enter the **IP Address** or **Domain Name** of the tested host.

4. Click **Start** to begin the diagnostics.

Tips:

Click **Advanced**, you can modify the ping count, ping packet size or the Traceroute Max TTL. It's recommended to keep the default value.

The figure below indicates the proper connection between the router and the Yahoo server (www.Yahoo.com) tested through **Ping**.

```
PING www.Yahoo.com (116.214.12.74): 64 data bytes
Reply from 116.214.12.74: bytes=64 ttl=50 seq=1 time=51.640 ms
Reply from 116.214.12.74: bytes=64 ttl=50 seq=2 time=53.671 ms
Reply from 116.214.12.74: bytes=64 ttl=50 seq=3 time=56.045 ms
Reply from 116.214.12.74: bytes=64 ttl=50 seq=4 time=57.857 ms

--- Ping Statistic "www.Yahoo.com" ---
Packets: Sent=4, Received=4, Lost=0 (0.00% loss)
Round-trip min/avg/max = 51.640/54.803/57.857 ms
```

The figure below indicates the proper connection between the router and the Yahoo server (www.Yahoo.com) tested through **Traceroute**.

```
traceroute to www.Yahoo.com (116.214.12.74), 20 hops max, 38 byte packets
 1 219.133.12.1 (219.133.12.1) 19.556 ms 22.274 ms 22.024 ms
 2 113.106.38.77 (113.106.38.77) 30.115 ms 22.649 ms 20.931 ms
 3 * * *
 4 183.56.65.14 (183.56.65.14) 26.210 ms 29.428 ms 28.272 ms
 5 * 202.97.60.25 (202.97.60.25) 29.272 ms 25.461 ms
 6 202.97.60.46 (202.97.60.46) 27.335 ms 27.616 ms 28.272 ms
 7 202.97.60.149 (202.97.60.149) 22.805 ms 24.024 ms 24.711 ms
 8 202.97.6.30 (202.97.6.30) 47.610 ms 54.452 ms 61.137 ms
 9 r4105-s2.tp.hinet.net (220.128.6.110) 51.171 ms 50.515 ms 56.107 ms
10 220.128.11.190 (220.128.11.190) 60.950 ms 60.200 ms 60.419 ms
```

12.3. Upgrade the Firmware

TP-LINK is dedicated to improving and enriching the product features, giving you a better network experience. We will release the latest firmware at TP-LINK official website, you can download the latest firmware file from the [Support](#) page of our website www.tp-link.com and upgrade the firmware to the latest version.

■ **Note:**

1. Make sure the latest firmware file is matched with the hardware version (as shown in the webpage).
2. Make sure that you have a stable connection between the router and your computer. It is NOT recommended to upgrade the firmware wirelessly.
3. Make sure you remove any USB storage device connected to the router before the firmware upgrade to prevent data loss.
4. Backup your router configuration.
5. Do NOT turn off the router during the firmware upgrade.

Follow the steps to upgrade the firmware.

1. Download the latest firmware file for the router from our website www.tp-link.com.
2. Visit <http://tplinkwifi.net>, and log in with the username and password you set for the router.
3. Go to [Advanced](#) > [System Tools](#) > [Firmware Upgrade](#).
4. Click [Browse](#) to locate the downloaded new firmware file, and click [Upgrade](#).

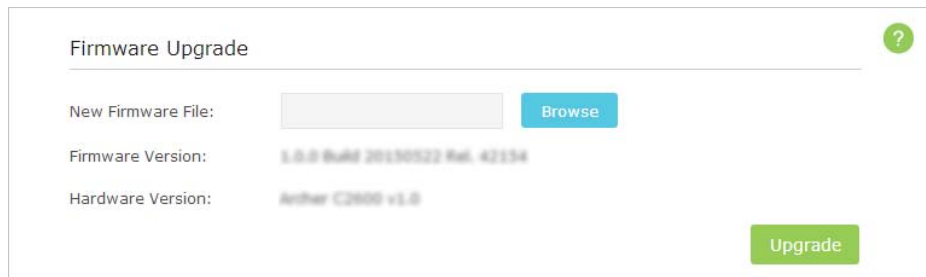

Firmware Upgrade

New Firmware File: [Browse](#)

Firmware Version: 1.0.0 B4M 20130522 Rel. 42134

Hardware Version: Archer C2600 v1.0

[Upgrade](#)

5. Wait a few moments for the upgrading and rebooting.

12.4. Backup and Restore Configuration Settings

The configuration settings are stored as a configuration file in the router. You can backup the configuration file to your computer for future use and restore the router to a previous settings from the backup file when needed. Moreover, if necessary you can erase the current settings and reset the router to the default factory settings.

1. Visit <http://tplinkwifi.net>, and log in with the username and password you set for the router.
2. Go to [Advanced](#) > [System Tools](#) > [Backup & Restore](#).

➤ **To backup configuration settings:**

Click [Backup](#) to save a copy of the current settings to your local computer. A '.bin' file of the current settings will be stored to your computer.

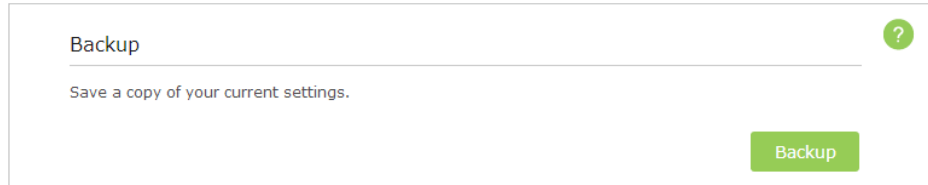

Backup

Save a copy of your current settings.

Backup

➤ **To restore configuration settings:**

1. Click [Browse](#) to locate the backup configuration file stored on your computer, and click [Restore](#).

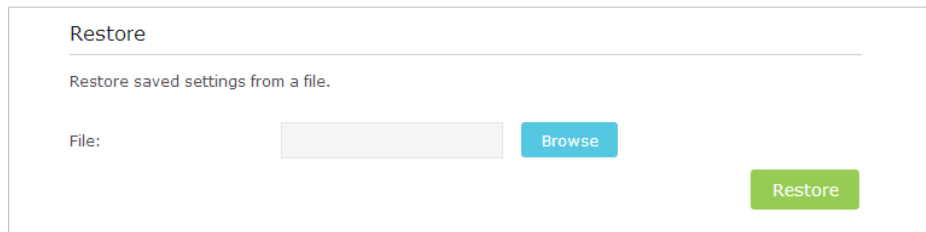

Restore

Restore saved settings from a file.

File: [Browse](#)

Restore

2. Wait a few moments for the restoring and rebooting.

📌 **Note:** During the restoring process, do not turn off or reset the router.

➤ **To reset the router to factory default settings:**

1. Click [Factory Restore](#) to reset the router.



Factory Default Restore

Revert all the configuration settings to their default values.

Factory Restore

2. Wait a few moments for the reset and reboot.

📌 **Note:**

1. During the resetting process, do not turn off or reset the router.
2. We strongly recommend you backup the current configuration settings before resetting the router.

12.5. Change the Administrator Account

The account management feature allows you to change your login username and password of the web-based management page.

1. Visit <http://tplinkwifi.net>, and log in with the username and password you set for the router before.

2. Go to *Advanced* > *System Tools* > *Administration* and complete the settings in *Account Management* section.

3. Enter the old username and old password. Enter the new username and enter the new password twice (both case-sensitive). Click *Save*.

Use the new username and password for the following logins.

12.6. Local Management

This feature allows you to limit the number of client devices on your LAN from accessing the router using the MAC address-based authentication.

1. Visit <http://tplinkwifi.net>, and log in with the username and password you set for the router.
2. Go to *Advanced* > *System Tools* > *Administration* and complete the settings In *Local Management* section according to your needs.
3. Keep the *Port* as the default setting. Enter the IP address or MAC address of the local device to manage the router.

Note:

1. The IP address of the local device must be in the same subnet as the router's LAN IP address.
2. If you want that all local devices can manage the router, just leave the *IP/MAC Address* field blank.

4. Click *Save* to make the settings effective. Now only the device using the IP address or MAC address you set can manage the router.

12.7. Remote Management

By default, the remote devices are not allowed to manage the router from the Internet. Follow the steps below to allow remote devices to manage the router.

1. Visit <http://tplinkwifi.net>, and log in with the username and password you set for the router.
2. Go to [Advanced](#) > [System Tools](#) > [Administration](#) page. Locate the [Remote Management](#) section.

Remote Management:	<input checked="" type="checkbox"/> Enable
Port:	<input type="text" value="80"/>
IP/MAC Address:	<input type="text" value="255.255.255.255"/>

[Save](#)

3. Tick the checkbox to enable [Remote Management](#).
 4. Keep the [Port](#) as the default setting. Enter the IP address or MAC address of the remote device to manage the router.
- Note:** If you want that all remote devices can manage the router, just leave the [IP/MAC Address](#) field blank.
5. Click [Save](#) to make the settings effective. Now, only the device using the IP address or MAC address you set can log in to <http://router's Internet IP address:port number> (such as <http://113.116.60.229:80>) to manage the router remotely.

Tips:

1. You can find the Internet IP address of the router on [Basic](#) > [Network Map](#) > [Internet](#).
2. The router's Internet IP is usually a dynamic IP. Please refer to [Set Up a Dynamic DNS Service Account](#) if you want to log in to the router through a domain name.

12.8. System Log

When the router does not work properly, you can save the system log and send it to the technical support for troubleshooting.

➤ To Save the System Log in Local:

1. Visit <http://tplinkwifi.net>, and log in with the username and password you set for the router.
2. Go to [Advanced](#) > [System Tools](#) > [System Log](#).

System Log ?

Type: ALL ▼

Level: Debug ▼

↻ Refresh ✖ Delete All

ID	Time	Type	Level	Log Content
426	2000-01-16 10:34:32	IGMP	Warning	V2 igmp router occurred! Not matching ours V3.
425	2000-01-16 10:33:51	IGMP	Warning	V2 igmp router occurred! Not matching ours V3.
424	2000-01-16 10:32:27	IGMP	Warning	V2 igmp router occurred! Not matching ours V3.
423	2000-01-16 10:31:46	IGMP	Warning	V2 igmp router occurred! Not matching ours V3.
422	2000-01-16 10:30:22	IGMP	Warning	V2 igmp router occurred! Not matching ours V3.
421	2000-01-16 10:29:41	IGMP	Warning	V2 igmp router occurred! Not matching ours V3.
420	2000-01-16 10:28:17	IGMP	Warning	V2 igmp router occurred! Not matching ours V3.
419	2000-01-16 10:27:36	IGMP	Warning	V2 igmp router occurred! Not matching ours V3.

< 1 2 3 4 5 6 7 8 ... 54 >

Log Settings
Save Log

To view the system logs:

1. Select the log Type. Select [ALL](#) to view all kinds of logs, or select [DHCP](#), [DHCPD](#) or [IGMP](#) to view the specific logs.
2. Select the log Level and you will see the logs with the specific or higher levels.
3. Click [Refresh](#) to refresh the log list.

To save the system logs:

You can choose to save the system logs to your local computer or a remote server.

Click [Save Log](#) to save the logs in a txt file to your computer.

Click [Log Settings](#) to set the save path of the logs.

Log Settings

Save Locally

Minimum Level: Information

Save Remotely

Minimum Level: Warning

Server IP: 192.168.1.100

Server Port: 514

Local Facility Name: User

Back Save

- **Save Locally:** Select this option to cache the system log to the router's local memory, select the minimum level of system log to be saved from the drop-down list. The logs will be shown in the table in descending order on the System Log page.
- **Save Remotely:** Select this option to send the system log to a remote server, select the minimum level of system log to be saved from the drop-down list and enter the information of the remote server. If the remote server has a log viewer client or a sniffer tool implemented, you can view and analyze the system log remotely in real-time.

12.9. SNMP Settings

SNMP (Simple Network Management Protocol) has been widely applied in the computer networks currently, which is used for ensuring the transmission of the management information between two nodes. In this way, network administrators can easily search and modify the information on any node on the network. Meanwhile, they can locate faults promptly and implement the fault diagnosis, capacity planning and report generating.

An **SNMP Agent** is an application running on the router that performs the operational role of receiving and processing SNMP messages, sending responses to the SNMP manager, and sending traps when an event occurs. So a router contains SNMP "agent" software can be monitored and/or controlled by SNMP Manager using SNMP messages.

1. Visit <http://tplinkwifi.net>, and log in with the username and password you set for the router.
2. Go to *Advanced* > *System Tools* > *SNMP Settings* page.

- **Enable SNMP Agent:** Toggle On to enable the built-in SNMP agent that allows the router to operate as the operational role in receiving and processing of SNMP messages, sending responses to the SNMP manager, and triggering SNMP traps when an event occurs.
- **Read Community:** Displays the default public community string that protects the router from unauthorized access.
- **Set Community:** Displays the default read and write community string that protects the router from unauthorized changes.
- **System Name:** Displays the administratively-assigned name for this managed device.
- **System Description:** Displays the textual description of the managed device. This value should include the full name and version identification of the system's hardware type, software operating-system, and networking software.
- **System Location:** Displays the physical location of this device (e.g., telephone closet, 3rd floor).
- **System Contact:** Displays the textual identification of the contact person for this managed device, together with information on how to contact this person.
- **Trap Manager IP:** Displays the IP address of the host to receive the traps.

You are suggested to keep the default settings. Click [Save](#) to make the settings effective.

12. 10. Monitor the Internet Traffic Statistics

The Traffic Statistics page displays the network traffic of the LAN, WAN and WLAN sent and received packets, allows you to monitor the volume of Internet traffic statistics.

1. Visit <http://tplinkwifi.net>, and log in with the username and password you set for the router.

2. Go to [Advanced](#) > [System Tools](#) > [Statistics](#).



3. Toggle on [Traffic Statistics](#), and then you can monitor the traffic statistics in [Traffic Statistics List](#) section.



















 **Tips:** This function is enabled by default.

Traffic Statistics ?

Enable Traffic Statistics:

Traffic Statistics List

 Refresh
 Reset
 Delete All

IP Address/ MAC Address	Total Packets	Total Bytes	Current Packets	Current Bytes	Current ICMP Tx	Current UDP Tx	Current SYN Tx	Modify
192.168.0.100 38:83:45:C8:47:56	40	13,120	8	3	3	0	5	 
192.168.0.101 40:16:9F:C8:A7:16	4	9,312	0	5	9	0	0	 
192.168.0.102 54:E6:FC:C7:47:5C	14	6,312	1	13	1	15	1	 
192.168.0.103 5C:63:BF:C7:AC:50	40	312	20	40	55	64	70	 
192.168.0.104 64:66:B3:A8:4E:51	4	3,126	0	10	0	0	0	 
192.168.0.105 64:70:02:B8:47:A6	45	1,319	1	0	4	0	9	 
192.168.0.106 6C:E8:73:C8:47:55	53	3,512	50	0	60	0	90	 
192.168.0.107 74:EA:3A:08:47:56	48	3,142	0	30	0	50	45	 
192.168.0.108 8C:21:0A:C8:07:56	49	3,212	12	56	23	78	89	 

Click [Refresh](#) to update the statistic information on the page.

Click [Reset All](#) to reset all statistic values in the list to zero.

Click [Delete All](#) to delete all statistic information in the list.

Click  to reset the statistic information of the specific device.

Click  to delete the specific device item in the list.

FAQ

Q1. What can I do if I forgot my wireless password?

The default password is labeled at the back of the router. If the password has been altered, please connect the router to the computer using a cable and follow the steps below:

1. Visit <http://tplinkwifi.net>, and log in with the username and password you set for the router.
2. Go to [Basic](#) > [Wireless](#), locate the password on the loading page, and mark down your new password for future use.

Q2. How to retrieve the username and password of the web management page?

The default username and password of the web management page are [admin](#) (in lower case). If the password has been altered, please follow the steps below:

1. Reset the router to factory default settings: While the router is powered on, press and hold the Reset button on the back for about 8 seconds until all LEDs go on, then release the button;
2. Visit <http://tplinkwifi.net>;
3. Enter [admin](#) (in lower case) as both username and password to login.

Note: You'll need to reconfigure the router to surf the Internet once the router is reset, and please mark down your new password for future use.

Q3. I cannot login to the router's web management page, what can I do?

This can happen for a variety of reasons, please try the methods below and try again.

1. Make sure the router connects to the computer correctly and the corresponding LED indicator(s) light up.
2. Make sure the IP address of your computer is configured as [Obtain an IP address automatically](#) and [Obtain DNS server address automatically](#).
3. Make sure the <http://tplinkwifi.net> you input is right.
4. Check your computer's settings:
 - 1) Go to [Start](#) > [Control Panel](#) > [Network and Internet](#), and click [View network status and tasks](#);
 - 2) Click [Internet Options](#) on the bottom left;
 - 3) Click [Connections](#), select [Never dial a connection](#);

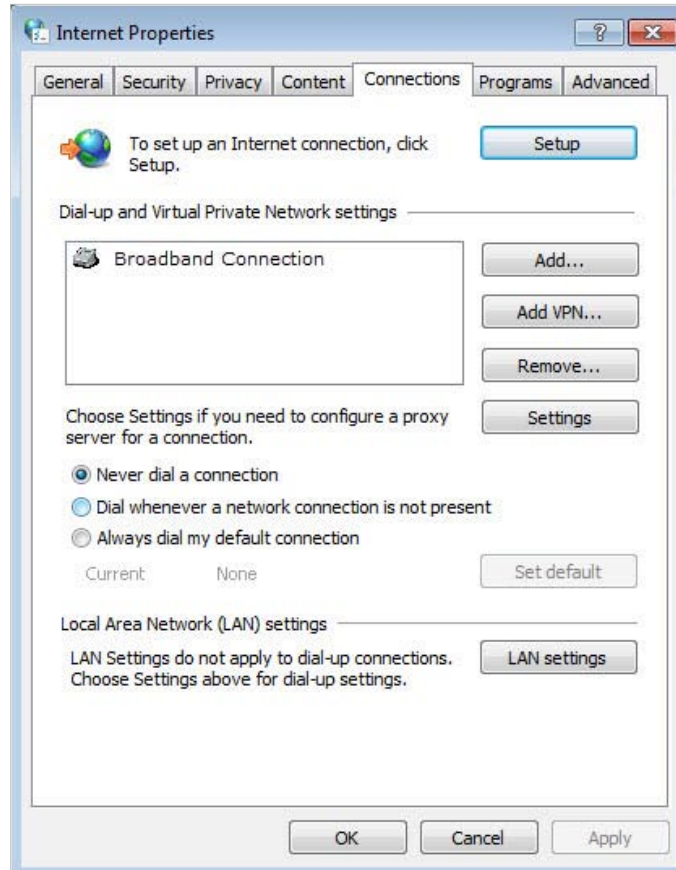

4) Click [LAN settings](#), deselect the following three options and click [OK](#);



5) Go to [Advanced](#) > [Restore advanced settings](#), click [OK](#) to save the settings.

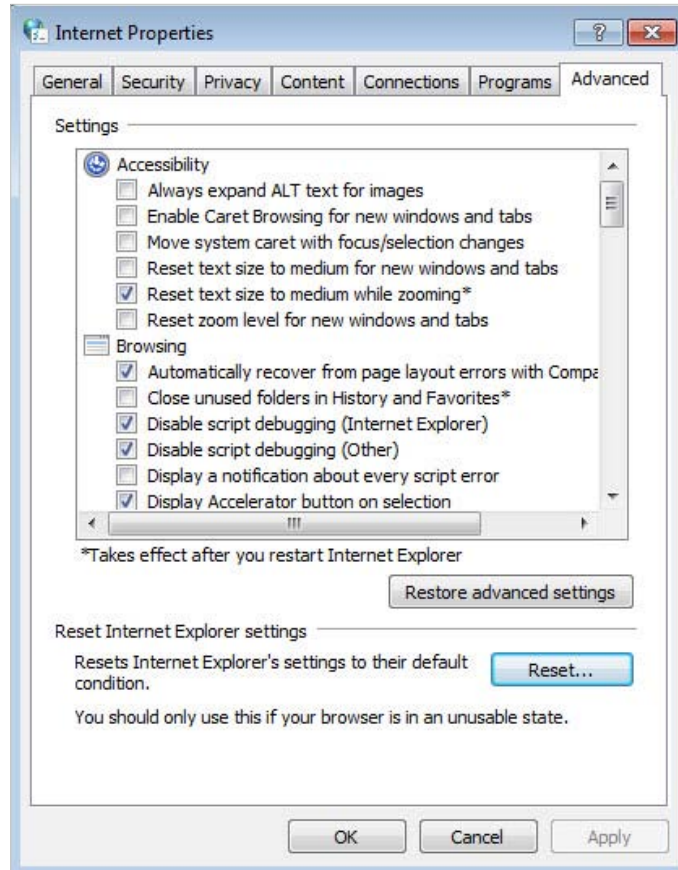

5. Change a web browser or computer and login again.

6. Reset the router to factory default settings: Press and hold the Reset button for at least 10 seconds and then release.

■ **Note:** You'll need to reconfigure the router to surf the Internet once the router is reset.

Open a web browser and login again. If login still fails, please contact the technical support.

Q4. I cannot access the Internet even though the configuration is finished, what can I do?

1. Visit <http://tplinkwifi.net>, and log in with the username and password you set for the router.

2. Go to *Advanced* > *Status* to check Internet status:

As the follow picture shows, if IP Address is a valid IP address, please try the methods below and try again:

Internet		IPv4 IPv6
MAC Address:	00-0A-EB-AC-88-16	
IP Address:	59.40.0.91	
Subnet Mask:	255.255.255.0	
Default Gateway:	59.40.0.1	
Primary DNS:	202.96.128.166	
Secondary DNS:	202.96.134.133	
Connection Type:	Dynamic IP	

1. Your computer might not recognize any DNS server addresses, please manually configure DNS server.

1) Go to [Advanced](#) > [Network](#) > [DHCP Server](#);

2) Enter 8.8.8.8 as Primary DNS, click [Save](#).

 **Tips:** 8.8.8.8 is a safe and public DNS server operated by Google.

DHCP Server	
DHCP:	<input checked="" type="checkbox"/> Enable DHCP
	<input checked="" type="radio"/> DHCP Server <input type="radio"/> DHCP Relay
IP Address Pool:	192.168.0.100 - 192.168.0.199
Address Lease Time:	120 minutes(1-2880)
Default Gateway:	192.168.0.1 (optional)
Default Domain:	(optional)
Primary DNS:	8.8.8.8 (optional)
Secondary DNS:	0.0.0.0 (optional)
Save	

2. Power cycle the modem and the TP-LINK router.

1) Power off your modem and TP-LINK router, leave them off for 1 minute;

2) Power on your modem first, wait about 2 minutes until it get a solid cable or Internet light;

3) Power back TP-LINK router;

4) Wait another 1 or 2 minutes and check the Internet access.

3. Reset the router to factory default settings and reconfigure.

Note: You'll have to reconfigure the router to access the Internet once the router is reset.

- 1) Reset the router to factory default settings: press and hold the RESET button for at least 10 seconds and then release;
- 2) Reconfigure the router with the help of *"4. 1. Quick Setup"*.

4. Please refer to *"12. 3. Upgrade the Firmware"* to upgrade the firmware of the router.

As the follow picture shows, if the IP Address is 0.0.0.0, please try the methods below and try again:



Internet		IPv4 IPv6
MAC Address:	00-0A-EB-AC-88-16	
IP Address:	0.0.0.0	
Subnet Mask:	0.0.0.0	
Default Gateway:	0.0.0.0	
Primary DNS:	0.0.0.0	
Secondary DNS:	0.0.0.0	
Connection Type:	None	

1. Check the physical connection.

Make sure the physical connection between the router and the modem is proper.

2. Clone the MAC address of your computer.

- 1) Visit <http://tplinkwifi.net>, and log in with the username and password you set for the router;
- 2) Go to *Advanced > Network > Internet*;
- 3) Choose an option to your need (Enter the MAC address if *Use Custom MAC Address* is selected), and click *Save*.

Tips:

- Some ISP will register the MAC address of your computer when you access the Internet for the first time through their Cable modem, if you add a router into your network to share your Internet connection, the ISP will not accept it as the MAC address is changed, so we need to clone your computer's MAC address to the router.
- The MAC addresses of a computer in wired connection and wireless connection are different.

3. Modify the LAN IP address of the router.

Note:

Most TP-LINK routers use 192.168.0.1/192.168.1.1 as their default LAN IP address, it may be conflicting with the IP range of your existent ADSL modem/router. If so, the router is not able to communicate with your modem and cause you can't access the Internet. To resolve the problem, we need to change the LAN IP address of the router to avoid such conflict, for example, 192.168.2.1.

- 1) Visit <http://tplinkwifi.net>, and log in with the username and password you set for the router;
- 2) Go to *Advanced* > *Network* > *LAN Settings*;
- 3) Modify the LAN IP address as the follow picture shows. Here we take 192.168.2.1 as an example;
- 4) Click *Save*.

4. Power cycle the modem and the TP-LINK router.

- 1) Power off your modem and TP-LINK router, leave them off for 1 minute;
- 2) Power on your modem first, wait about 2 minutes until it get a solid cable or Internet light;
- 3) Power back TP-LINK router;
- 4) Wait another 1 or 2 minutes and check the Internet access.

5. Double check the Internet Connection Type.

- 1) Confirm your Internet Connection Type, which can be learned from the ISP;
- 2) Visit <http://tplinkwifi.net>, and log in with the username and password you set for the router;
- 3) Go to *Advanced* > *Network* > *Internet*;
- 4) Select your **Internet Connection Type** and fill in other parameters with the help of page tips;
- 5) Click **Save**.

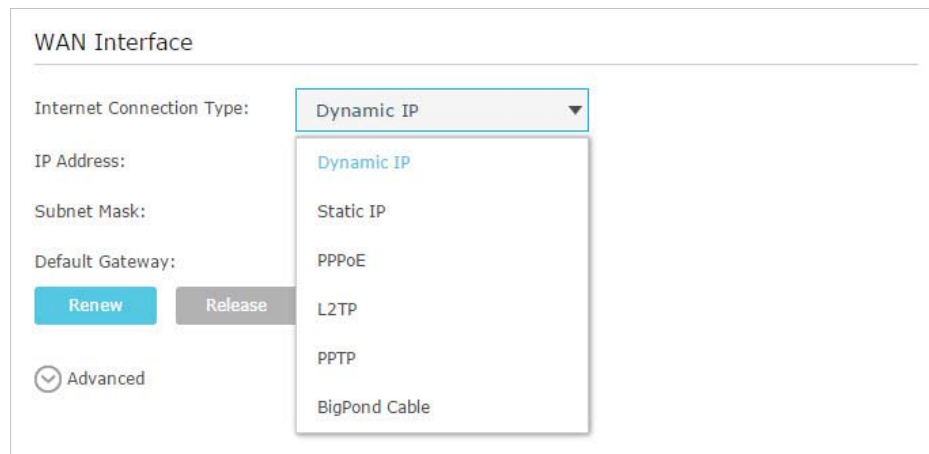

6) Power cycle the modem and the TP-LINK router again.

3. Please refer to *"12. 3. Upgrade the Firmware"* to upgrade the firmware of the router.
4. Check the TCP/IP settings on the particular device if all other devices can get Internet from the router.

If you've tried every method above but cannot access the Internet, please contact the technical support.

Q5. I cannot find my wireless network or I cannot connect the wireless network, what can I do?

If you fail to find any wireless network, please follow the steps below:

1. Make sure the wireless function is enabled if you're using a laptop with built-in wireless adapter. You can refer to the relevant document or contact the laptop manufacturer.
2. Make sure the wireless adapter driver is installed successfully and the wireless adapter is enabled.

• On Windows 7

- 1) If you see the message **No connections are available**, it is usually because the wireless function is disabled or blocked somehow;

2) Clicking on [Troubleshoot](#) and windows might be able to fix the problem by itself.

• **On Windows XP**

- 1) If you see the message [Windows cannot configure this wireless connection](#), this is usually because windows configuration utility is disabled or you are running another wireless configuration tool to connect the wireless;
- 2) Exit the wireless configuration tool(the TP-LINK Utility, for example);
- 3) Select and right click on [My Computer](#) on desktop, select [Manage](#) to open Computer Management window;
- 4) Expand [Services and Applications](#) > [Services](#), find and locate [Wireless Zero Configuration](#) in the Services list on the right side;
- 5) Right click [Wireless Zero Configuration](#), and then select [Properties](#);
- 6) Change [Startup type](#) to [Automatic](#), click on Start button and make sure the Service status is Started. And then click [OK](#);
- 7) Connect to wireless network.

If you can find other wireless network except your own, please follow the steps below:

1. Check the WLAN LED indicator on your wireless router/modem;
2. Make sure your computer/device is still in the range of your router/modem, move closer if it is currently too far away;
3. Go to [Advanced](#) > [Wireless](#) > [Wireless Settings](#), and check the wireless router settings, double check your Wireless Network Name, make sure the wireless is not hidden;

The screenshot displays the 'Wireless Settings' page of a router's web interface. At the top right, there are frequency options: '2.4GHz | 5GHz'. The settings are as follows:

- Wireless Radio:** Enable Wireless Radio
- Wireless Network Name (SSID):** TP-LINK_0507 Hide SSID
- Security:** WPA/WPA2 Personal(Recommended) (dropdown menu)
- Version:** Auto WPA2-PSK
- Encryption:** Auto TKIP AES
- Password:** 12345670
- Mode:** 802.11bgn mixed (dropdown menu)
- Channel:** Auto (dropdown menu)
- Channel Width:** Auto (dropdown menu)
- Transmit Power:** Low Middle High

A green 'Save' button is located at the bottom right of the settings panel.

4. Connect to wireless network.

If you can find your wireless network but fail to connect, please follow the steps below:

- Authenticating problem, password mismatch:

1. Sometimes it will ask you to type in a PIN number when you connect to the wireless network for the first time. This PIN number is different from the Wireless Password/ Network Security Key, usually you can only find it on the back of your wireless router;



2. If you cannot find the PIN or PIN failed, you may choose [Connecting using a security key instead](#), and then type in the [Wireless Password/Network Security Key](#);
3. If it continues on saying [Network Security Key Mismatch](#), it is suggested to confirm the wireless password of your wireless router;

■ Note: Wireless Password/Network Security Key is case sensitive.

4. Connect to wireless network.

- Windows was unable to connect to XXXX /Can not join this network/Taking longer than usual to connect to this network:
 - 1) Check the wireless signal strength of your network, if it is weak (1~3 bars), please move the router closer and try again;
 - 2) Change the wireless Channel of the router to 1,6,or 11 to reduce interference from other networks;
 - 3) Re-install or update the driver for your wireless adapter of the computer;
 - 4) Connect to wireless network.

Q6.How to use the WDS Bridging function to extend my wireless network?

My house covers a large area. The wireless network coverage of the router I'm using (the root router) is limited. I want to use an extended router to extend the wireless network of the primary router. Follow the steps to configure the router.

1. Visit <http://tplinkwifi.net>, and log in with password you set for the router.

- Configure the [LAN IP address](#) of the router in the same subnet as the root router. For example, the IP address of the root router is 192.168.0.1, the IP address of the extended router should be from 192.168.0.2 to 192.168.0.254.).
- Go to [Advanced](#) > [System Tools](#) > [System Parameters](#) page and locate the [WDS](#) section.
- Select the check box to enable the WDS Bridging function.

WDS Bridging: Enable WDS Bridging

Wireless Network Name (SSID): [Survey](#)









MAC Address (to be bridged):

Security: No Security WPA/WPA2 Personal WEP

[Save](#)

- Click [Survey](#) to scan all the AP devices and choose the root AP to be bridged.

AP List [Refresh](#)

ID	BSSID	SSID	Signal strength	Channel	Encryption	Connect
1	40:16:9F:BF:58:13	TP-LINK_5811_5G	69	116	Encrypted	
2	0C:30:01:13:4F:DC	TP-LINK_4FDD_5G	69	100	Encrypted	
3	00:0A:EB:13:09:68	TP-LINK_0969_5G_1	61	36	Encrypted	
4	00:1D:0F:BF:51:14	TP-LINK_5116_5G	46	157	Encrypted	
5	00:0A:EB:13:09:67	TP-LINK_0969_5G_2	45	157	Encrypted	
6	F8:1A:67:2E:E8:36	TP-LINK_5G_E836	44	149	None	
7	40:16:9F:BF:59:15	TP-LINK_5913_5G	41	36	Encrypted	
8	00:14:78:22:33:55	TP-LINK_5G_223355	38	36	None	

[Back](#)

- Click the connect icon and then the SSID and MAC will be automatically filled in. Configure the Security settings as the AP you choose to be bridged.

WDS Bridging:	<input checked="" type="checkbox"/> Enable WDS Bridging
Wireless Network Name (SSID):	<input type="text" value="TP-LINK_5811_5G"/> <input type="button" value="Survey"/>
MAC Address (to be bridged):	<input type="text" value="40:16:9F:BF:58:13"/>
Security:	<input type="radio"/> No Security <input checked="" type="radio"/> WPA/WPA2 Personal <input type="radio"/> WEP
Version:	<input type="radio"/> WPA-PSK <input checked="" type="radio"/> WPA2-PSK
Encryption:	<input type="radio"/> TKIP <input checked="" type="radio"/> AES
Password:	<input type="text" value="1234567890"/>
	<input type="button" value="Save"/>

7. Click [Save](#) to make the settings effective.

8. Go to [Advanced](#) > [Network](#) > [DHCP Server](#) page to disable DHCP.

Now, the root router's wireless network is extended and you can use the Archer C50's SSID and password to enjoy the network.

Specifications

Hardware	
Ethernet Ports	4 10/100Mbps LAN Ports 1 10/100Mbps WAN Port
USB Port	1 USB 2.0 Ports
Button	WPS/Reset Button, Wireless On/Off Button, Power On/Off Button
External Power Supply	12V/2A
Antenna	Two external antennas(I-Pex), 2.4G gain: 2.41 dBi / 5G gain: 2.48dBi
Wireless	
Wireless Standards	IEEE 802.11ac/n/a 5GHz, IEEE 802.11b/g/n 2.4GHz
Frequency	2.4GHz, 5GHz
Signal Rate	867Mbps at 5GHz, 300Mbps at 2.4GHz
Transmit Power	CE: <20dBm(2.4GHz), <23dBm(5GHz) FCC: <30dBm
Reception Sensitivity	5GHz: 11a 54Mbps:-76dBm; 11ac VHT20 MCS8: -70dBm; 11ac VHT40 MCS9: -65.5dBm; 11ac VHT80 MCS9: -61.5dBm 2.4GHz: 11g 54M: -76dBm; 11n HT20: -74dBm; 11n HT40: -71dBm
Wireless Function	Enable/Disable Wireless Radio, WDS Bridge, WMM, Wireless Statistics
Wireless Security	64/128-bit WEP, WPA/WPA2, WPA2-PSK encryptions
Software	
WAN Type	Dynamic IP/Static IP/PPPoE/PPTP/L2TP/Bigpond Cable
DHCP	Server, Client, DHCP Client List, Address Reservation
Quality of Service	WMM, Bandwidth Control
Port Forwarding	Virtual Server, Port Triggering, UPnP, DMZ
Dynamic DNS	DynDns, NO-IP
Access Control	Parental Control, Local Management Control, Host list, Access Schedule, Rule Management
Firewall Security	SPI Firewall, IP Address Filter/Domain Filter, IP and MAC Address Binding
Protocols	Supports IPv4 and IPv6
USB Sharing	Supports FTP Server/Media Server/Printer Server
Management	Access Control, Local Management, Remote Management
Guest Network	2.4GHz guest network x 1, 5GHz guest network x 1
Environment	
Operating Temperature	0°C~40°C (32°F ~104°F)
Storage Temperature	-40°C~70°C (-40°F ~158°F)
Operating Humidity	10%~90% non-condensing
Storage Humidity	5%~90% non-condensing

COPYRIGHT & TRADEMARKS

Specifications are subject to change without notice. **TP-LINK**[®] is a registered trademark of TP-LINK TECHNOLOGIES CO., LTD. Other brands and product names are trademarks or registered trademarks of their respective holders.

No part of the specifications may be reproduced in any form or by any means or used to make any derivative such as translation, transformation, or adaptation without permission from TP-LINK TECHNOLOGIES CO., LTD. Copyright © 2016 TP-LINK TECHNOLOGIES CO., LTD. All rights reserved.

FCC STATEMENT



This equipment has been tested and found to comply with the limits for a Class B digital device, pursuant to part 15 of the FCC Rules. These limits are designed to provide reasonable protection against harmful interference in a residential installation. This equipment generates, uses and can radiate radio frequency energy and, if not installed and used in accordance with the instructions, may cause harmful interference to radio communications. However, there is no guarantee that interference will not occur in a particular installation. If this equipment does cause harmful interference to radio or television reception, which can be determined by turning the equipment off and on, the user is encouraged to try to correct the interference by one or more of the following measures:

Reorient or relocate the receiving antenna.

Increase the separation between the equipment and receiver.

Connect the equipment into an outlet on a circuit different from that to which the receiver is connected.

Consult the dealer or an experienced radio/ TV technician for help.

This device complies with part 15 of the FCC Rules. Operation is subject to the following two conditions:

This device may not cause harmful interference.

This device must accept any interference received, including interference that may cause undesired operation.

Any changes or modifications not expressly approved by the party responsible for compliance could void the user's authority to operate the equipment.

Note: The manufacturer is not responsible for any radio or TV interference caused by unauthorized modifications to this equipment. Such modifications could void the user's authority to operate the equipment.

FCC RF Radiation Exposure Statement

This equipment complies with FCC RF radiation exposure limits set forth for an uncontrolled environment. This device and its antenna must not be co-located or operating in conjunction with any other antenna or transmitter.

"To comply with FCC RF exposure compliance requirements, this grant is applicable to only Mobile Configurations. The antennas used for this transmitter must be installed to provide a separation distance of at least 20 cm from all persons and must not be co-located or operating in conjunction with any other antenna or transmitter."

The device is restricted in indoor environment only.

Canadian Compliance Statement

This device complies with Industry Canada license-exempt RSS standard(s). Operation is subject to the following two conditions:

1. This device may not cause interference, and
2. This device must accept any interference, including interference that may cause undesired operation of the device.

Cet appareil est conforme aux normes CNR exemptes de licence d' Industrie Canada. Le fonctionnement est soumis aux deux conditions suivantes:

1. cet appareil ne doit pas provoquer d' interférences et
2. cet appareil doit accepter toute interférence, y compris celles susceptibles de provoquer un fonctionnement non souhaité de l' appareil.

Caution:

1. The device for operation in the band 5150 - 5250 MHz is only for indoor use to reduce the potential for harmful interference to co-channel mobile satellite systems;
2. For devices with detachable antenna(s), the maximum antenna gain permitted for devices in the band 5725-5850 MHz shall be such that the equipment still complies with the e.i.r.p. limits specified for point-to-point and non-point-to-point operation as appropriate; and

The high-power radars are allocated as primary users (i.e. priority users) of the bands 5250-5350 MHz and 5650-5850 MHz and that these radars could cause interference and/or damage to LE-LAN devices.

Avertissement:

1. Le dispositif fonctionnant dans la bande 5150-5250 MHz est réservé uniquement pour une utilisation à l' intérieur afin de réduire les risques de brouillage préjudiciable aux systèmes de satellites mobiles utilisant les mêmes canaux;
2. Le gain maximal d' antenne permis pour les dispositifs avec antenne(s) amovible(s) utilisant la bande 5725-5850 MHz doit se conformer à la limitation P.I.R.E spécifiée pour l' exploitation point à point et non point à point, selon le cas.

En outre, les utilisateurs devraient aussi être avisés que les utilisateurs de radars haute puissance sont désignés utilisateurs principaux (c.-à-d., qu' ils ont la priorité) des bandes 5250-5350 MHz et 5650-5850 MHz et que ces radars pourraient causer du brouillage et/ou des dommages aux dispositifs LAN-EL.

Radiation Exposure Statement:

This equipment complies with IC radiation exposure limits set forth for an uncontrolled environment. This equipment should be installed and operated with minimum distance 20cm between the radiator & your body.

Déclaration d' exposition aux radiations:

Cet équipement est conforme aux limites d' exposition aux rayonnements IC établies pour un environnement non contrôlé. Cet équipement doit être installé et utilisé avec un minimum de 20 cm de distance entre la source de rayonnement et votre corps.



Industry Canada Statement

CAN ICES-3 (B)/NMB-3(B)

Safety Information

- When product has power button, the power button is one of the way to shut off the product; when there is no power button, the only way to completely shut off power is to disconnect the product or the power adapter from the power source.
- Don' t disassemble the product, or make repairs yourself. You run the risk of elect shock and voiding the limited warranty. If you need service, please contact us.
- Avoid water and wet locations.
- Adapter shall be installed near the equipment and shall be easily accessible.
- The plug considered as disconnect device of adapter.

Explanation of the symbols on the product label

Symbol	Explanation
	DC voltage
	RECYCLING This product bears the selective sorting symbol for Waste electrical and electronic equipment (WEEE). This means that this product must be handled pursuant to European directive 2012/19/EU in order to be recycled or dismantled to minimize its impact on the environment.
	User has the choice to give his product to a competent recycling organization or to the retailer when he buys a new electrical or electronic equipment.